

**FEDERATION
REFERENCE
SERIES**

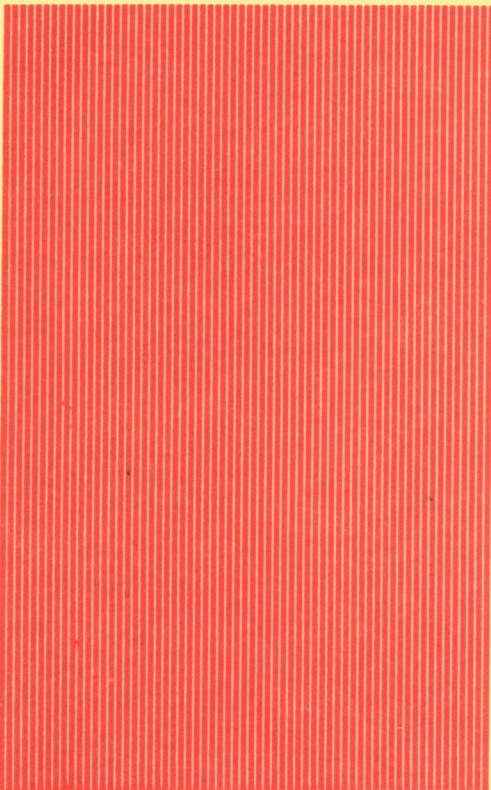

TERRANGLO LANGUAGE EDITION



**AUTHORIZED
PERSONNEL ONLY**
SECURITY LEVEL TWO

UNITED FEDERATION OF PLANETS
STAR FLEET DIVISION

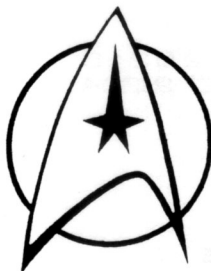

FEDERATION
REFERENCE SERIES

RS: 480371

THE REFERENCE REPORTS CONTAINED HEREIN ARE FOR THE FAMILIARIZATION OF STAR FLEET ACADEMY MIDSHIPMEN AND ARE HARD FORMAT COMPILATIONS OF MATERIAL CONTAINED IN THE DATA FILES OF THE MASTERCOMPUTER, STAR FLEET HEADQUARTERS, EARTH. UNDER THE LAWS OF THE UNITED FEDERATION OF PLANETS AND ITS MEMBERS UNAUTHORIZED USE, OR REPRODUCTION, IN WHOLE OR IN PART, OF THESE REPORTS OR ANY SUBSEQUENTLY ISSUED, WITHOUT THE PERMISSION OF THE OFFICE OF THE JUDGE ADVOCATE GENERAL OF STAR FLEET IS STRICTLY PROHIBITED.

TERRANGLO LANGUAGE EDITION

UPDATED & APPROVED FOR TERRAN YEAR 2288

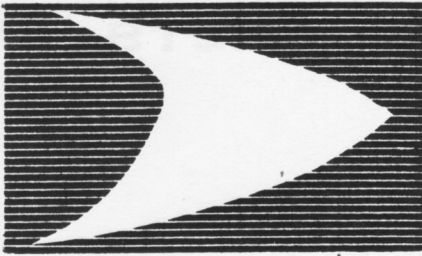

**STAR
FLEET**
PRINTING OFFICE

P. O. BOX 20215
BALTO., MD 21204

FEDERATION REFERENCE SERIES

IS THE NAME USED FOR ALL HARD FORMAT COMPILATIONS OF FEDERATION TECHNICAL ORDERS ISSUED BY EITHER THE STAR FLEET OR MERCHANT FLEET DIVISIONS FOR USE IN THEIR TRAINING PROGRAMS. THIS COMPILATION HAS BEEN PREPARED BY STAR FLEET PRINTING OFFICE BY ORDER OF THE DEPUTY CHIEF OF STAR FLEET PERSONNEL FOR USE BY FIRST YEAR MIDSHIPMEN UNDER HIS COMMAND.

ATTENTION: CERTAIN MATERIAL INCLUDED HEREIN HAS BEEN CLASSIFIED SECURITY LEVEL TWO BY THE DIRECTOR OF CLASSIFICATIONS, BUREAU OF INTELLIGENCE. UNAUTHORIZED USE OF SUCH MATERIAL IS PUNISHABLE BY COURTMARTIAL AND IMPRISONMENT.

SUPERVISING EDITOR:
KRISDULAS MIN AR, RADM SFPO

ASSOCIATE EDITOR, SPACECRAFT:
TODD GUENTHER, COMM STARSTATION AURORA

CONTRIBUTING EDITORS:
ROBERT DAY, ALLEN EVERHART, MICHAEL MORRISSETTE, JOHN TROTTA

MEMORY ALPHA AND SFHQ MASTERCOM CATALOGING DATA:
UFP/SFD DTA RS:480371

COPYRIGHT ©1985 STAR FLEET PRINTING OFFICE



GENERAL DIVISION INDEX

RS: 480371*1-6

TECHNICAL ORDERS ARE CONSTANTLY BEING ISSUED BY THE VARIOUS OFFICES OF THE STAR FLEET DIVISION THROUGH THE BUREAU OF OPERATIONS. THESE ORDERS FORM THE BASIS FOR THE REFERENCE REPORTS CONTAINED HEREIN. TECHNICAL ORDERS AND, SUBSEQUENTLY, REFERENCE REPORTS, ARE IDENTIFIED BY A "TECHNICAL ORDER NUMBER". A SERIES OF FIVE CODES (WHICH ARE, FROM LEFT TO RIGHT, THE GENERAL DIVISION, FILE, SECTION, SUBSECTION AND ITEM CODES) MAKE UP THIS TECHNICAL ORDER NUMBER. THE INDEX BELOW DEFINES SOME OF THE GENERAL DIVISION AND FILE CODES TO GIVE THE READER AN IDEA OF HOW THE DATA THAT IS BEING VIEWED IS STORED. ONLY THOSE CODES WHICH HAVE BEEN APPROVED FOR SECURITY LEVEL TWO ARE INCLUDED.

00: GENERAL DATA**00:00: INTRODUCTORY MATERIALS**

- 00:01: UNITED FEDERATION OF PLANETS ARTICLES OF FEDERATION, STATUTES, REGULATIONS, TREATIES, ETC.
- 00:02: FLAGS, SEALS, ARMS AND OTHER DEVICES IDENTIFYING THE UNITED FEDERATION OF PLANETS AND ITS MEMBERS
- 00:03: UNIFORMS, INSIGNIA AND RANKS OF THE UNITED FEDERATION OF PLANETS OTHER THAN THE STAR FLEET DIVISION
- 00:04: SPACECRAFT AND WEAPONRY OF THE UNITED FEDERATION OF PLANETS OTHER THAN THE STAR FLEET DIVISION
- 00:05: UNIFORMS, INSIGNIA AND RANKS OF ALIEN CULTURES NOT PART OF THE UNITED FEDERATION OF PLANETS
- 00:06: SPACECRAFT AND WEAPONRY OF ALIEN CULTURES NOT PART OF THE UNITED FEDERATION OF PLANETS
- 00:07: COMMUNICATION METHODS
- 00:08: LIFE FORMS

01: COMMAND DATA**01:00: INTRODUCTORY MATERIALS**

- 01:01: STAR FLEET DIVISION- GENERAL INFORMATION
- 01:02: STAR FLEET DIVISION- ASSIGNMENT AND GENERAL ORDERS, PRIME DIRECTIVES, REGULATIONS, ETC.
- 01:03: STAR FLEET DIVISION- UNIFORMS, INSIGNIA AND RANKS
- 01:04: STAR FLEET DIVISION- SPACECRAFT CLASSIFICATIONS
- 01:05: STAR FLEET DIVISION- SPACECRAFT RECORDS
- 01:06: STAR FLEET DIVISION- DUTY SHIP SPECIFICS
- 01:07: STAR FLEET DIVISION- SPACECRAFT DEFENSIVE SYSTEMS
- 01:08: STAR FLEET DIVISION- SPACECRAFT OFFENSIVE SYSTEMS

02: SCIENCES DATA**02:00: INTRODUCTORY MATERIALS**

- 02:01: STAR FLEET DIVISION- GENERAL INFORMATION
- 02:02: STAR FLEET DIVISION- SPACECRAFT COMPUTER SYSTEMS
- 02:03: STAR FLEET DIVISION- LABORATORY SPECIFICS
- 02:04: STAR FLEET DIVISION- SCIENTIFIC INSTRUMENTS AND EQUIPMENT
- 02:06: STAR FLEET DIVISION- NAVIGATION INFORMATION
- 02:07: STAR FLEET DIVISION- COSMOGRAPHIC DATA (M-O GALACTIC)
- 02:08: STAR FLEET DIVISION- COSMOGRAPHIC DATA (EXTRAGALACTIC)
- 02:10: STAR FLEET DIVISION- MEDICAL INFORMATION
- 02:11: STAR FLEET DIVISION- MEDICAL INSTRUMENTS AND EQUIPMENT
- 02:14: STAR FLEET DIVISION- HEALTH AND SAFETY STANDARDS, ETC.



GENERAL DIVISION INDEX

RS: 480371*1-6

03: SUPPORT SERVICES DATA

03:00: INTRODUCTORY MATERIALS

03:01: STAR FLEET DIVISION- COMMUNICATIONS INFORMATION

03:02: STAR FLEET DIVISION- COMMUNICATIONS EQUIPMENT

03:05: STAR FLEET DIVISION- ENVIRONMENTAL MANAGEMENT INFORMATION

03:06: STAR FLEET DIVISION- ENVIRONMENTAL MANAGEMENT FACILITIES, EQUIPMENT, ETC.

03:08: STAR FLEET DIVISION- ENGINEERING INFORMATION

03:09: STAR FLEET DIVISION- SPACECRAFT STRUCTURAL DETAILS

03:10: STAR FLEET DIVISION- SPACECRAFT SUBLIGHT PROPULSION DETAILS

03:11: STAR FLEET DIVISION- SPACECRAFT HYPERLIGHT PROPULSION DETAILS

03:12: STAR FLEET DIVISION- SPACECRAFT POWER GENERATION DETAILS

03:13: STAR FLEET DIVISION- SPACECRAFT CONTROLS DETAILS

03:14: STAR FLEET DIVISION- SPACECRAFT ONBOARD FOOD SYSTEMS DETAILS

03:15: STAR FLEET DIVISION- SPACECRAFT WASTE REGENERATION SYSTEMS DETAILS

03:16: STAR FLEET DIVISION- SPACECRAFT TRANSPORTER SYSTEMS DETAILS

03:17: STAR FLEET DIVISION- SPACECRAFT FLIGHT AND HANGER DECK SYSTEMS DETAILS

03:18: STAR FLEET DIVISION- SPACECRAFT COMPUTER SYSTEMS DETAILS

03:19: STAR FLEET DIVISION- SPACECRAFT MAINTENANCE AND REPAIR SYSTEMS DETAILS

03:20: STAR FLEET DIVISION- SPACECRAFT FABRICATION SYSTEMS DETAILS

03:21: STAR FLEET DIVISION- SPACECRAFT MATERIALS RECONVERSION SYSTEMS DETAILS

03:22: STAR FLEET DIVISION- SPACECRAFT CHEMOPHOTOSYNTHESIS SYSTEMS DETAILS

03:23: STAR FLEET DIVISION- SPACECRAFT SPECIALIZED EQUIPMENT

03:24: STAR FLEET DIVISION- SPACECRAFT CARGO FACILITIES

03:98: STAR FLEET DIVISION- SPACECRAFT RECREATION SYSTEMS AND FACILITIES

RS: 480371.1



TO:00:00:08:00.02

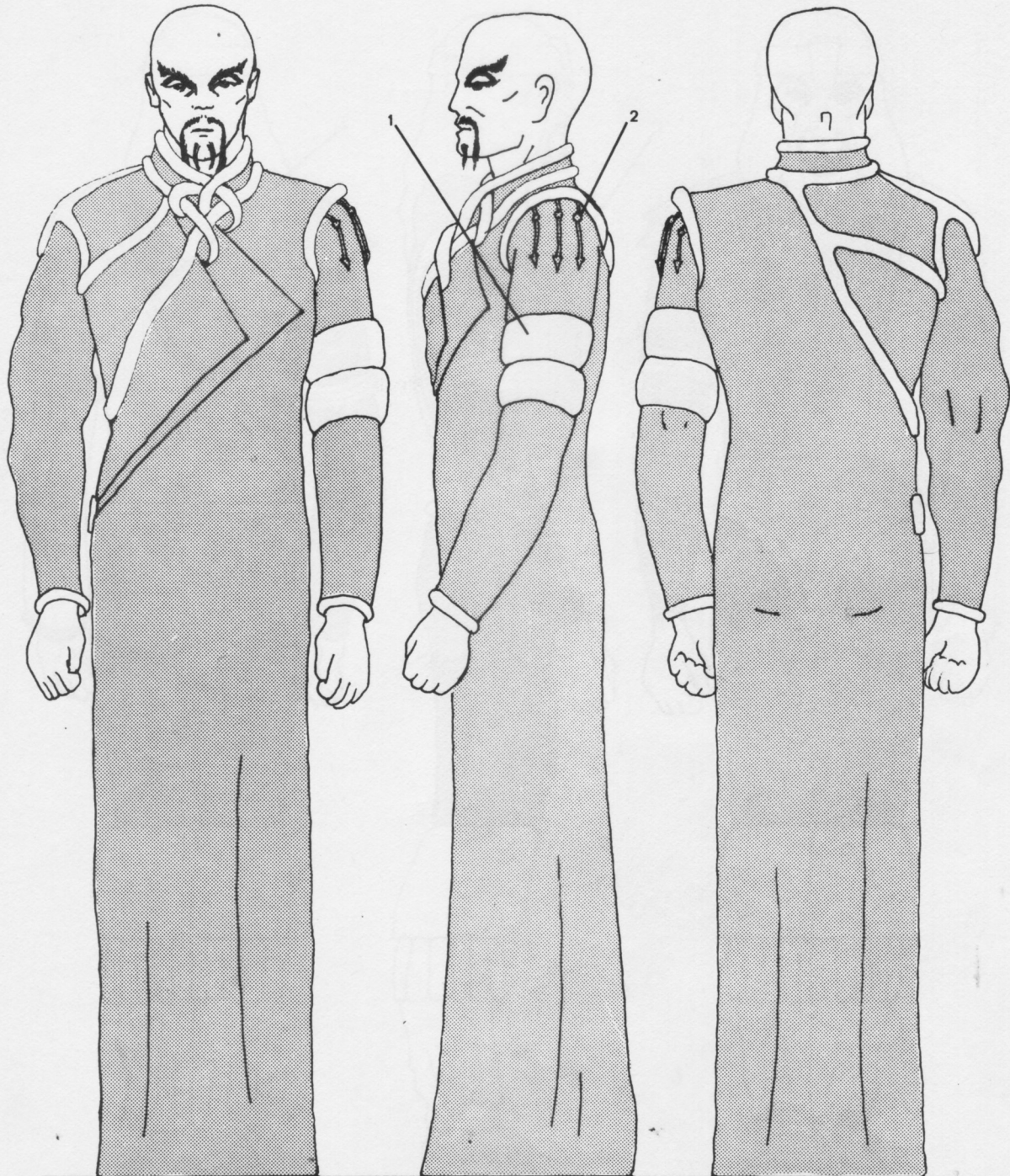

CEREMONIAL ROBE

KLINGON IMPERIAL FLEET-NAADAN PRIEST



	FSC 259 DEEP MAROON
	FSC 001 WHITE

1-GROUP OR DIVISION DESIGNATION?
2-RANK DESIGNATION?

RS: 480371.1



TO:00:05:01:01.10

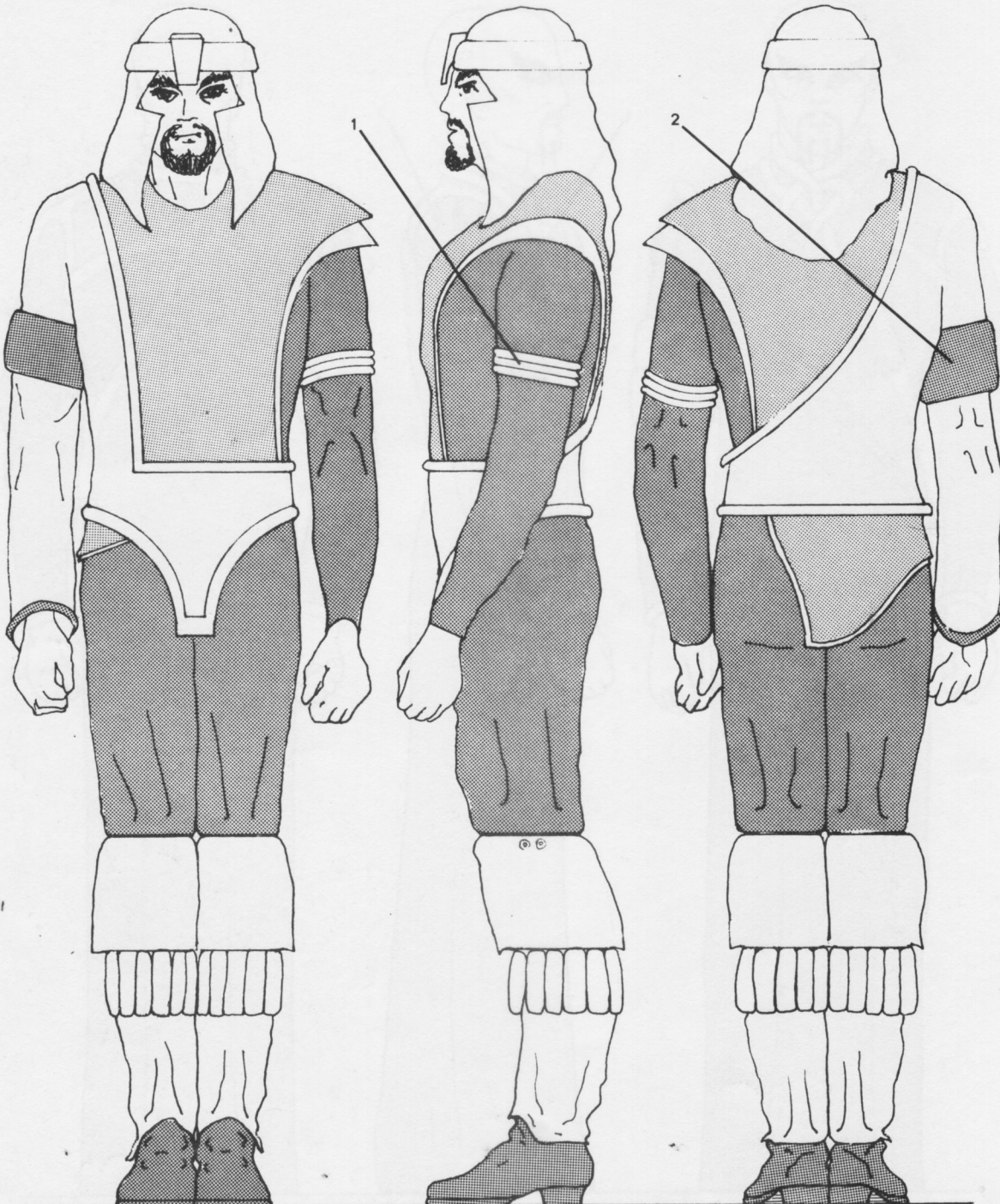

COMBAT GARMENT

KLINGON IMPERIAL STRIKE FORCE-ALL RANKS



-  FSC 119 OLIVE
-  FSC 497 DARK BROWN
-  FSC 408 MEDIUM BROWN-GRAY

1-RANK DESIGNATION?
2-GROUP OR DIVISION DESIGNATION?

RS: 480371.1



TO:00:05:01:02.01

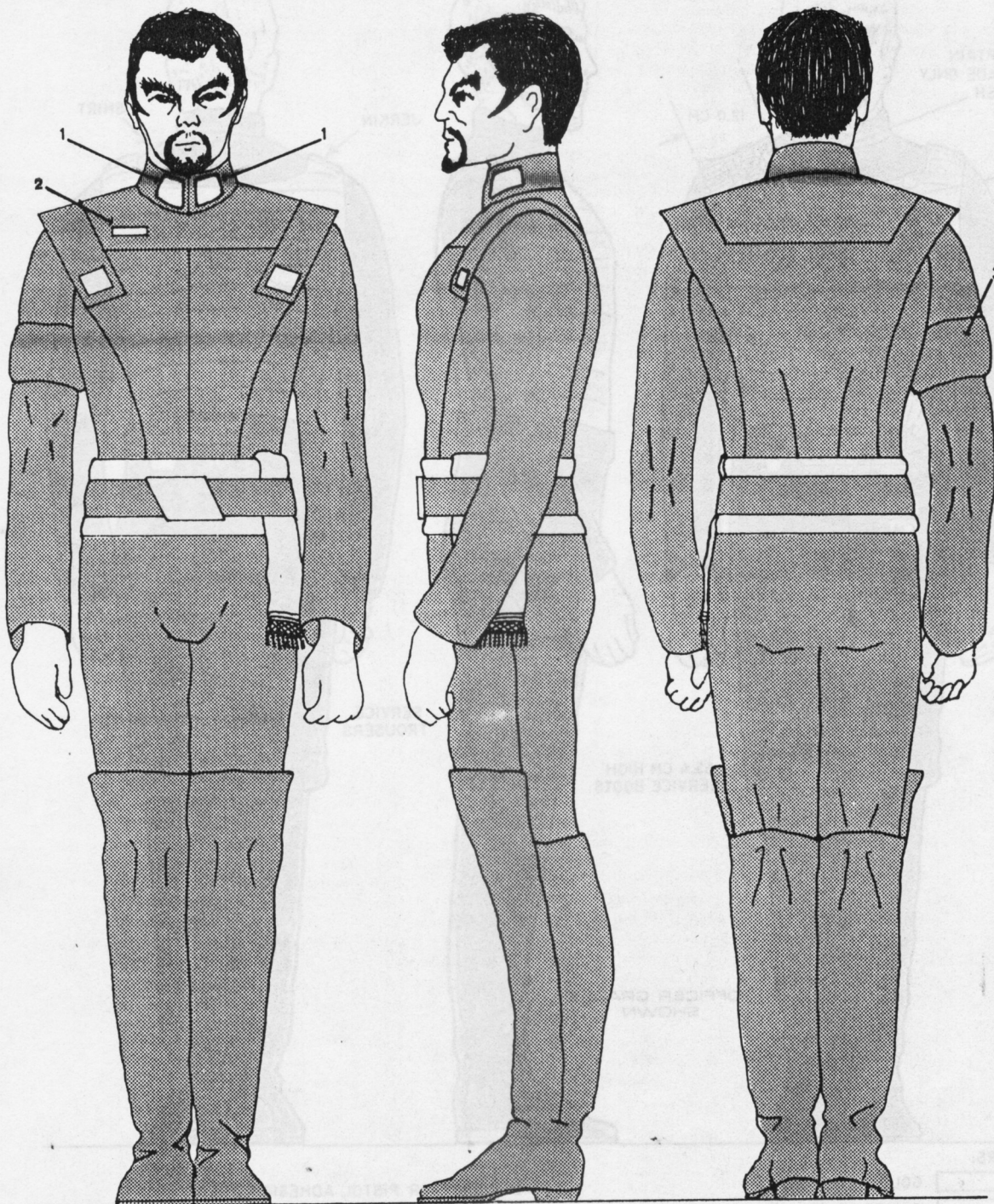

DRESS UNIFORM

KLINGON IMPERIAL BLOODWATCH (INTERNAL SECURITY FORCE) - ALL RANKS



-  FSC 1000 BLACK
-  FSC 206 MEDIUM RED

- 1-RANK DESIGNATION?
- 2-UNIT BADGE?
- 3-GROUP OR DIVISION DESIGNATION?

RS: 480371.2

TO: 00:05:01:03.01

AUTHENTICATED STARDATE 8209.44

AMENDMENT CODE: OR



KLINGON WARSHIP

CLASS ONE CODE D MK VII BACKGROUND & CLASS LISTING

BACKGROUND OF KLOLODE CLASS:

AROUND SD 3900 STAR FLEET INTELLIGENCE BEGAN GETTING INDICATIONS THAT THE KLINGON FLEET WAS INVOLVED IN THE CONSTRUCTION AND TESTING OF A NEW BATTLECRUISER DESIGN. INTELLIGENCE INTERCEPTS SUBSEQUENTLY REVEALED THE CONFIGURATION AND COMPONENT PRODUCERS FOR THE NEW KLOLODE CLASS, AS WELL AS THE IMPERIAL PLANNING COUNCIL'S ORIGINAL PROJECTIONS FOR CONSTRUCTION OF TWENTY SHIPS.

THE EXISTENCE OF A COMPLETED KLOLODE CLASS VESSEL WAS NOT VERIFIED UNTIL SD 4014.40 WHEN A SURVEILLANCE DRONE LAUNCHED FROM THE GAMMA THREE STATION NEAR DONATU INTERCEPTED A CODED TRANSMISSION FROM THE BATTLECRUISER GORTUK. THE NAME AND IDENTIFICATION CODE OF THIS VESSEL MATCHED THOSE OF THE THIRD BATTLECRUISER SCHEDULED FOR COMPLETION. VISUAL TRANSMISSIONS FROM THE DRONE VERIFIED THAT THIS WAS ONE OF THE NEWLY DESIGNED WARSHIPS.

THE FIRST CONTACT WITH ONE OF THE VESSELS CAME ON SD 4201.71 WHEN THE STARSHIP CONSTELLATION (NCC-1017) DISCOVERED AN INTRUDER IN THE SAURIAN STAR SYSTEM IN FEDERATION SPACE. AN INDECISIVE BATTLE FOLLOWED, RESULTING IN MINOR DAMAGE TO CONSTELLATION AND A HASTY RETREAT TO KLINGON SPACE FOR THE BATTLECRUISER, WHICH BORE THE DESIGNATION ATROPOS ON ITS HULL.

AS A RESULT OF THE CLOSE OBSERVATION AFFORDED BY THE BATTLE, MUCH VALUABLE DATA CONCERNING THE NEW SHIP'S CAPABILITIES AND GENERAL BATTLEWORTHINESS WAS OBTAINED. ABOVE ALL ELSE, IT WAS FOUND TO BE EXTREMELY WARP DYNAMIC. LOW MASS ALLOWED FOR RAPID DEVELOPMENT OF OCM NECESSARY FOR WARP ENTRY. THE VESSEL'S EXTREMELY SMOOTH HULL REFLECTED THE THEN-PREVALENT VIEW AMONG KLINGON DESIGNERS REGARDING THE BALANCING OF DEFLECTOR/FORCE FIELD CAPABILITIES AND WARP DYNAMIC QUALITIES. (SUBSEQUENT KLINGON ADVANCES IN WARP TECHNOLOGY HAVE ALLOWED GREATER SHIELDING WITHOUT SACRIFICE OF SPEED, AS FIRST EVIDENCED IN THE K'T'INGA DESIGN).

AS SHIPS OF THIS CLASS AGED THE KLINGONS BEGAN SELLING SOME OF THE OLDER ONES TO THE ROMULANS IN EXCHANGE FOR THE RIGHT TO BUY THEIR NEWLY-DEVELOPED CLOAKING GENERATORS. STARSHIP ENTERPRISE CONFIRMED SUSPICIONS TO THIS EFFECT ON SD 6215.43 WHEN IT ENCOUNTERED A PACK OF THREE OF THE KLOLODE CLASS VESSELS UNDER ROMULAN COMMAND.

THOUGH THE EXISTENCE OF ONLY 21 KLOLODE CLASS BATTLECRUISERS HAS BEEN CONFIRMED, IT IS BELIEVED THAT A TOTAL OF 45-60 WERE BUILT, WITH SOME 15 (7 CONFIRMED) HAVING BEEN SOLD TO THE ROMULAN FLEET TO DATE. WHILE FOR SOME TIME IT WAS THOUGHT THAT SHIPS OF THIS AGING CLASS WOULD BE UPDATED TO MATCH THE MORE POWERFUL BUT PHYSICALLY SIMILAR K'T'INGA CONFIGURATION, THIS DOES NOT SEEM TO HAVE BEEN THE CASE. THE KLINGON IMPERIAL FLEET SEEMS CONTENT TO LET THE VESSELS WEAR THEMSELVES OUT.

LISTING OF KNOWN KLOLODE CLASS BATTLECRUISERS:

NAME (TRANSLATION)	I.D. NUMBER	EXISTENCE VERIFIED	STATUS
ATROPOS (INVINCIBLE)	KL 10097	SD 4201.71 BY CONSTELLATION (NCC-1017)	ACTIVE
FLETHISH (PROMINENCE)	CHR 222	SD 6283.01 BY JENGHIZ (NCC-501)	IN ROMULAN SERVICE
GORTUK (FURIOUS)	KL 08422	SD 4014.40 BY SURVEILLANCE DRONE	UNKNOWN
HAKASK (HORRENDOUS)	KL 99019	SD 4141.07 BY GAMMA TWO STATION	ACTIVE
JURAKTE (ASSASSIN)	KL 32533	SD 5547.69 BY MONITOR (NCC-1713)	ACTIVE
KAHLESS (THE MERCILESS ONE)	KL 08405	SD 4392.41 BY MERCHANT VESSEL	UNKNOWN
KLATHAS (PESTILENCE)	KL 68953	SD 5689.38 BY FEDERATION (NCC-2100)	ACTIVE
KLOLODE (DESTRUCTION)	KL 02529	SD 4267.15 BY DIANA (NCC-589)	ACTIVE
KLOTHOS (CARNAGE)	KL 99970	SD 4517.23 BY CONSTITUTION (NCC-1700)	ACTIVE
LACHESIS (HAVOC)	KL 66065	SD 4972.80 BY ETZEL (NCC-509)	UNKNOWN
LUCTAS (STARFIRE)	CHR 316	SD 6215.43 BY ENTERPRISE (NCC-1701)	IN ROMULAN SERVICE
MAKITA (EXECUTIONER)	KL 31060	SD 4765.20 BY MERCHANT VESSEL	ACTIVE
MARTA (CORONA)	CHR 333	SD 6348.17 BY CONSTITUTION (NCC-1700)	IN ROMULAN SERVICE
MENINARÇA (GAUNTLET)	CHR 400	SD 6317.12 BY EARTH OUTPOST TWO	IN ROMULAN SERVICE
N'LANAES (PREDATOR)	CHR 385	SD 6215.43 BY ENTERPRISE (NCC-1701)	IN ROMULAN SERVICE
PARNO (BROADSWORD)	CHR 381	SD 6215.43 BY ENTERPRISE (NCC-1701)	IN ROMULAN SERVICE
TABOR (POWERFUL)	KL 85269	SD 4517.23 BY CONSTITUTION (NCC-1700)	ACTIVE
THANATOS (VENGEANCE)	KL 63573	SD 4696.34 BY SHAITAN (NCC-519)	ACTIVE
TOR'STOG (DEVISER)	KL 73796	SD 4958.81 BY BONHOMME RICHARD (NCC-1712)	DESTROYED
TRELINITU (STARLIGHT)	CHR 566	SD 6216.28 BY POTEPMKIN (NCC-1711)	IN ROMULAN SERVICE
TUER (MURDEROUS ONE)	KL 74717	SD 5405.27 BY DELTA ONE STATION	ACTIVE

RS: 480371.2

TO: 00:06:01:07:01

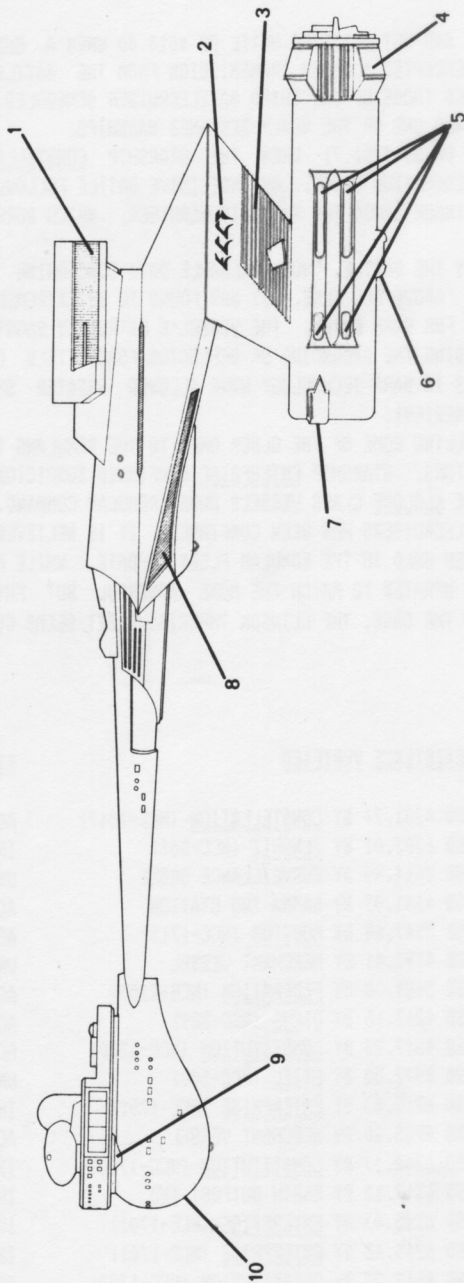

UNITED FEDERATION OF PLANETS
STAR FLEET DIVISION
BUREAU OF OPERATIONS - OFFICE OF RECORDS

GENERAL PLANS	SPACECRAFT CLASS: CLASS ONE KLINGON WARSHIP
MODEL: CODE D MK-VII	TYPE: BATTLECRUISER
GENERATED BY: MASTERCOM SFHQ	NOMINAL CLASS: KLOLODE
	SCALE: 1:1766

SUBFILE TWO: OUTBOARD PROFILE

RS:480371-2

TD:00:06:01:07.02

SPECIFICS:

- 1. MAIN POWER PLATE-P/S
- 2. NOMINAL I.D.
- 3. EMERGENCY FLUSH VENT-P/S
- 4. MAIN ENERGY REACTION STAGE
- 5. MAIN INTERCOOLERS
- 6. FLUX CONSTRICTOR
- 7. BOLSONIUM ENGINE SHIELD
- 8. HYDROGEN RAM INTAKE-F/S
- 9. DISRUPTOR MOUNT (2)
- 10. PHOTON TORPEDO TUBE





STAR FLEET REFERENCE REPORT

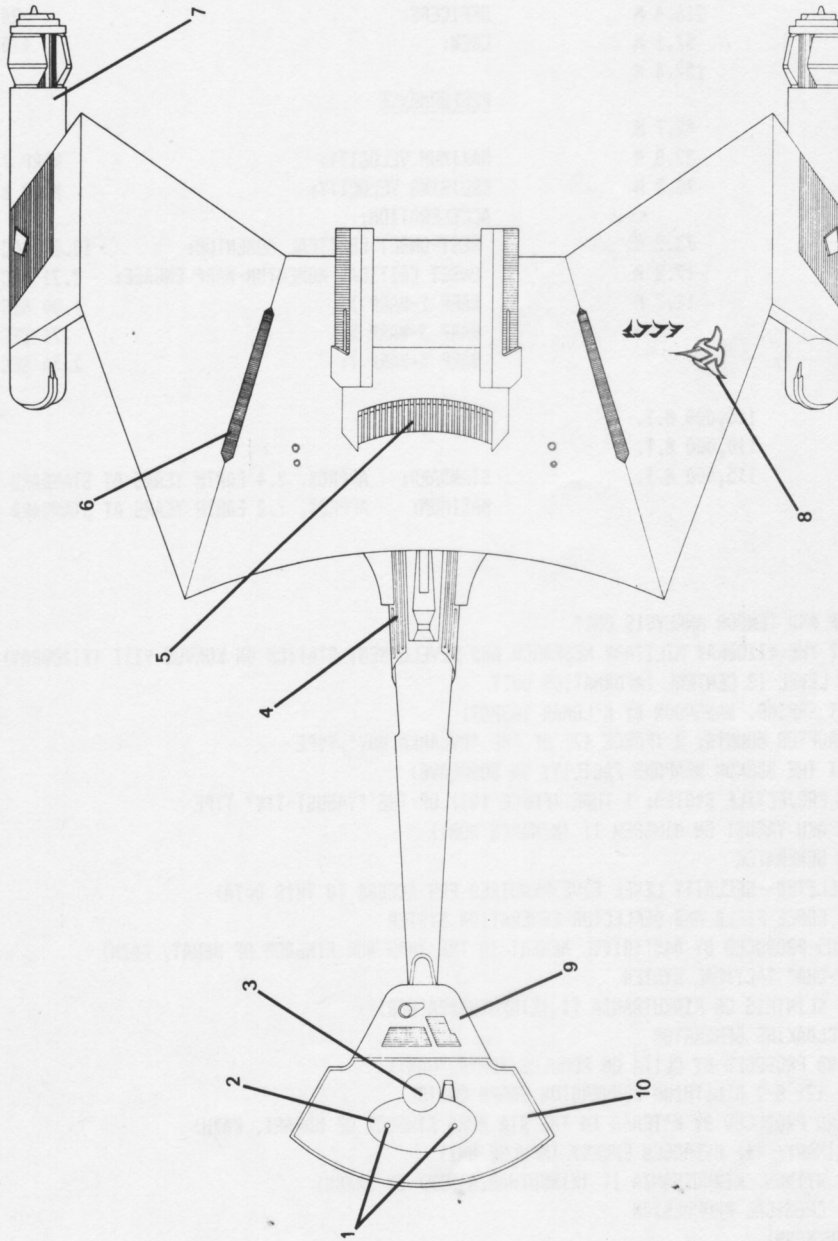

SUBFILE THREE: OUTBOARD TOP VIEW

RS: 480371-2

10:00:06:01:07.03

SPECIFICS:

- 1. NAVIGATIONAL BEACONS
- 2. BRIDGE
- 3. PRIMARY SENSOR ARRAY
- 4. REACTOR COOLING SYSTEM-P/S
- 5. MATTER INTAKE
- 6. HYDROGEN BYPASS VENTS-P/S
- 7. GRAPH UNITS-P/S
- 8. KLINGON FLEET EMBLEM
- 9. ENGINEERING SECTION
- 10. FORECASTLE

UNITED FEDERATION OF PLANETS
STAR FLEET DIVISION
 BUREAU OF OPERATIONS - OFFICE OF RECORDS

GENERAL PLANS	SPACECRAFT CLASS: CLASS ONE KLINGON WARSHIP
MODEL: CODE D MK-VII	NOMINAL CLASS: KLOLODE
GENERATED BY: MASTERCORP SFHQ	TYPE: BATTLECRUISER
	SCALE: 1:1366





KLINGON WARSHIP

CLASS ONE CODE D MK VII SPECIFICATIONS

CURRENT SPECIFICATIONS OF KLOLODE CLASS:

DIMENSIONS

OVERALL LENGTH: 216.4 M
 OVERALL DRAUGHT: 57.1 M
 OVERALL BEAM: 152.4 M

PRIMARY HULL LENGTH: 42.7 M
 PRIMARY HULL DRAUGHT: 32.8 M
 PRIMARY HULL BEAM: 48.8 M

NACELLE LENGTH: 73.2 M
 NACELLE DRAUGHT: 17.8 M
 NACELLE BEAM: 11.2 M

DISPLACEMENT

LIGHT: 105,000 M.T.
 STANDARD: 110,000 M.T.
 FULL LOAD: 115,000 M.T.

SHIP'S COMPLEMENT

OFFICERS: 24
 CREW: 430

PERFORMANCE

MAXIMUM VELOCITY: WARP 7
 CRUISING VELOCITY: WARP 6
 ACCELERATION:
 REST-ONSET CRITICAL MOMENTUM: 10.28 SEC
 ONSET CRITICAL MOMENTUM-WARP ENGAGE: 2.21 SEC
 WARP 1-WARP 3: 1.00 SEC
 WARP 3-WARP 5: .71 SEC
 WARP 5-WARP 7: 2.36 SEC

DURATION

STANDARD: APPROX. 2.4 EARTH YEARS AT STANDARD COMPLEMENT
 MAXIMUM: APPROX. 7.2 EARTH YEARS AT STANDARD COMPLEMENT

SYSTEMS

NAVIGATION: "CHON" VECTOR AND TENSOR ANALYSIS UNIT
 (DEVELOPED AT THE XIXOBRAX MILITARY RESEARCH AND DEVELOPMENT STATION ON KORVUS VIII (XIXOBRAX))

COMPUTERS: "KROTUS'MOR" LEVEL 12 CENTRAL INFORMATION UNIT
 (DEVELOPED AT SAPIAR, WANGROON BY K'LOMAR TASHUT)

WEAPONS: GRAVITIC DISRUPTOR MOUNTS: 2 (FORCE 47) OF THE "OVLARKA MOY" TYPE
 (DEVELOPED AT THE BOSKON WEAPONS FACILITY ON BOSKLAIVE)
 MAGNO-PHOTON PROJECTILE SYSTEM: 1 TUBE (FORCE 103) OF THE "YAGUST-TIK" TYPE
 (PRODUCED BY AKU YAGUST ON MINGREN II (MINGREN'MOR))
 STASIS FIELD GENERATOR

(SPECIFICS DELETED--SECURITY LEVEL FIVE REQUIRED FOR ACCESS TO THIS DATA)
 DEFENSE: "MENGAT PUL" FORCE FIELD AND DEFLECTOR GENERATION SYSTEM
 (DEVELOPED AND PRODUCED BY DAS'TRIVIL MENGAT IN THE ZHAN BUR KINGDOM OF MERAT, KAZH)
 "SORG'TU VWE-CHA" TACTICAL SYSTEM
 (PRODUCED BY KLINTHIS ON KINKUTHANZA II (KINKUTHANZA'MOR))
 "CLITIMERA" CLOAKING GENERATOR

(DEVELOPED AND PRODUCED BY CLITA ON ROMULUS (CH'RI'HAN))
 PROPULSION: HYPERPHOTIC: (2) S-2 DILITHIUM CONVERSION GRAPH UNITS
 (DEVELOPED AND PRODUCED BY K'TCHAR IN THE STA MURA KINGDOM OF KOMARI, KAZH)
 SUBPHOTIC PRIMARY: (1) HYDROGEN ENERGY IMPULSE UNIT
 (PRODUCED AT HYINGA, KINKUTHANZA II (KINKUTHANZA'MOR) BY HAKSU)
 MANUEVERING: CHEMICAL PROPULSION
 (SPECIFICS UNKNOWN)

LIFE SUPPORT: ARTIFICIAL GRAVITY GENERATOR
 (SPECIFICS UNKNOWN)
 RADIATION PROTECTION SYSTEM
 (DEVELOPED AND PRODUCED BY DAS'TRIVIL MENGAT IN THE ZHAN BUR KINGDOM OF MERAT, KAZH)
 "BAR'AK" WASTE REGENERATION AND SHIP'S MAINTENANCE SYSTEM
 (PRODUCED BY TRIN'AK ON SIF III (SIF'KELT))

RS: 480371.2

TO:00:06:01:07.09



KLINGON WARSHIP

CLASS ONE CODE D MK VIII BACKGROUND & CLASS LISTING

BACKGROUND OF K'T'INGA CLASS:

ON SD 6411.10 THE HEAVY CRUISER CONSTITUTION (NCC-1700) ENCOUNTERED WHAT AT FIRST WAS BELIEVED TO BE A KLOLODE CLASS BATTLECRUISER DEEP IN FEDERATION SPACE NEAR THE GAMMA KANARIS SYSTEM. AFTER INTERCEPTING A CODED HIGH SPEED TRANSMISSION SPURT FROM THE SHIP, CONSTITUTION DISCOVERED THIS TO BE A MEMBER OF A NEW CLASS OF HEAVY BATTLECRUISERS WHICH STAR FLEET HAD PREVIOUSLY BEEN UNAWARE OF. UPON ENGAGING THE VESSEL (NAMED YKIR), CONSTITUTION FOUND IT QUITE SIMILAR TO THE KLOLODE CLASS IN CONFIGURATION BUT WITH MUCH GREATER FIREPOWER AND DEFLECTOR CAPABILITY. SUFFERING GREAT DAMAGE FROM THE ENCOUNTER, CONSTITUTION BARELY ESCAPED INTACT.

SHAKEN BY THEIR IGNORANCE, STAR FLEET IMMEDIATELY STARTED INTENSIVE INTELLIGENCE GATHERING EFFORTS GEARED TO FIND OUT MORE ABOUT THE NEW HEAVY BATTLECRUISER DESIGN. BEFORE LONG ENOUGH DATA HAD BEEN AMASSED TO TELL THAT THIS WAS A MUCH IMPROVED DESIGN WHICH, GIVEN THE KLINGON'S SHIPBUILDING SCHEDULE, POSED A GRAVE THREAT TO THE SECURITY OF FEDERATION TERRITORIES ALONG THE DISPUTED KLINGON-FEDERATION BORDER.

ON SD 6752.40, AS PART OF THESE INTELLIGENCE GATHERING ACTIVITIES, STAR FLEET MONITOR STATION EPSILON NINE WAS ACCUMULATING DATA ON AN ATTACK GROUP CONSISTING OF THREE OF THE NEW HEAVY BATTLECRUISERS THAT WERE ATTACKING AN ENORMOUS SPACECRAFT INTRUDING IN KLINGON SPACE. THE INTRUDER, WHICH TURNED OUT TO BE THE FAMOUS V'GER SPACE PROBE, TOTALLY ANIHILATED THE GROUP, BUT NOT BEFORE MUCH VALUABLE INFORMATION WAS OBTAINED ON THEIR ATTACK CAPABILITIES.

TOWARDS THE END OF THE 2270'S IT WAS DISCOVERED THAT THE KLINGONS WERE SELLING NEW VESSELS OF THIS K'T'INGA CLASS (NAMED FOR THE FIRST SHIP KNOWN TO HAVE BEEN BUILT) TO THE ROMULANS. THIS STARTLING DEVELOPMENT LED STAR FLEET TO ASSESS (CORRECTLY AS IT TURNED OUT) THAT THE KLINGONS WERE READYING AN IMPROVED DESIGN WHICH WOULD BE EVEN MORE BATTLEWORTHY THAN THE K'T'INGAS. THIS NEW DESIGN, COVERED IN SUBFILES 00:06:01:09.00-09, WAS FOUND TO BE THE K'TEREMMY CLASS DESTROYER.

LISTING OF KNOWN K'T'INGA CLASS HEAVY BATTLECRUISERS:

NAME (TRANSLATION)	I.D. NUMBER	EXISTENCE VERIFIED	STATUS
AMAR (REVENGE)	KL 98520	SD 6752.40 BY EPSILON NINE STATION	DESTROYED
ARAKKAB (INDIGNANT)	KL 11805	SD 6752.40 BY EPSILON NINE STATION	DESTROYED
CH'LITHINE (JAVELIN)	CHR 718	SD 7614.03 BY <u>LAFAYETTE</u> (NCC-1720)	IN ROMULAN SERVICE
CRENITAS (BATTLEQUEEN)	CHR 724	SD 7893.07 BY <u>BELKNAP</u> (NCC-2501)	IN ROMULAN SERVICE
EELST (HUNTER)	KL 83452	SD 6752.40 BY EPSILON NINE STATION	DESTROYED
EHHAK (VENOMOUS)	KL 88685	SD 8114.06 BY <u>LEANDER</u> (NCC-2521)	ACTIVE
EKRU (FIRE)	KL 99594	SD 6664.37 BY SURVEILLANCE DRONE	ACTIVE
KENEK (THE RULER OF MANY)	KL 17767	SD 7545.08 BY <u>RELIANT</u> (NCC-1864)	UNKNOWN
KIVORD (TUMULTUOUS)	KL 05431	SD 6419.24 BY <u>YORKTOWN</u> (NCC-1704)	ACTIVE
K'T'INGA (GREAT POWERFUL CONQUEROR)	KL 99634	SD 6932.48 BY EPSILON ONE STATION	ACTIVE
LOSU (COLD)	KL 40200	SD 7067.42 BY <u>ENTERPRISE</u> (NCC-1701)	ACTIVE
MAKE' (DEATH)	KL 67348	SD 6835.57 BY <u>ACHERNAR</u> (NCC-1732)	UNKNOWN
MALIG (TERROR)	KL 65481	SD 6526.71 BY <u>SPAKER</u> (NCC-596)	ACTIVE
MEJAB (THIEF)	KL 80124	SD 6524.40 BY MERCHANT VESSEL	ACTIVE
MENHADEN (KING)	KL 74350	SD 8343.11 BY EPSILON FOUR STATION	UNKNOWN
NAWRYA (SUCCESS)	KL 69916	SD 6635.42 BY SURVEILLANCE DRONE	UNKNOWN
SKELPF (BATTLE)	KL 09893	SD 7977.83 BY <u>RESOLUTION</u> (NCC-1877)	ACTIVE
YKIR (USURPER)	KL 17674	SD 6411.10 BY <u>CONSTITUTION</u> (NCC-1700)	ACTIVE
UNKNOWN	KL 35635	SD 7646.18 BY SURVEILLANCE DRONE	UNKNOWN
UNKNOWN	KL 99817	SD 7348.02 BY EPSILON SEVEN STATION	UNKNOWN
UNKNOWN	KL 26803	SD 7079.14 BY SURVEILLANCE DRONE	UNKNOWN

RS: 480371.2

TO: 00:06:01:08.01

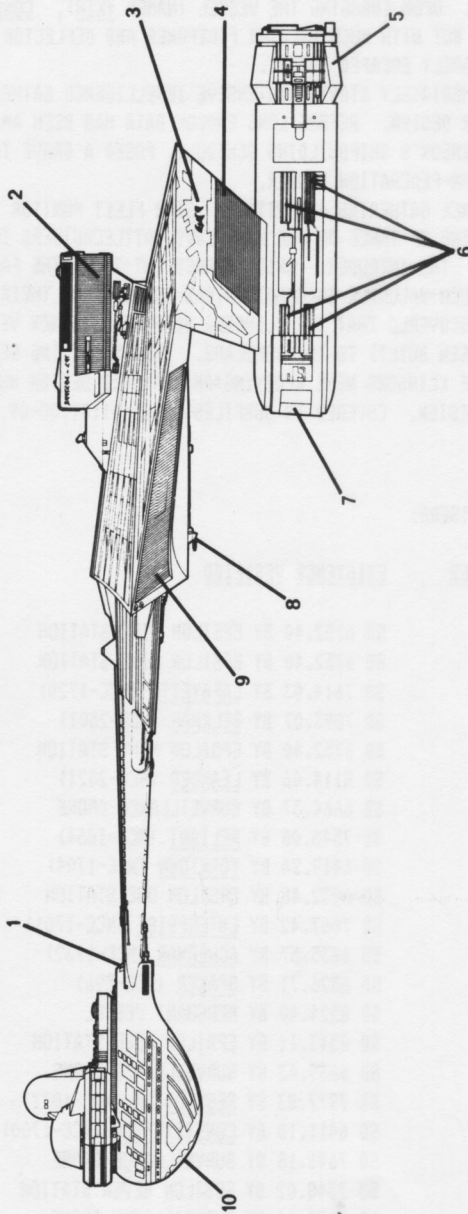

SUBFILE TWO: OUTBOARD PROFILE

RS: 480371-2

TO: 00:06:01:08.02

SPECIFICS:

1. OBSERVATION DECK
2. MAIN POWER PLATES-P/S
3. NOMINAL I.D.
4. EMERGENCY FLUSH VENT-P/S
5. MAIN ENERGY REACTION STAGE
6. MAIN INTERCOOLERS
7. BOLOGNIUM ENGINE SHIELD
8. DISRUPTOR MOUNT (8)
9. HYDROGEN RAM INTAKE-P/S
10. PHOTON TORPEDO TUBE (2)-F/A

UNITED FEDERATION OF PLANETS
STAR FLEET DIVISION
 BUREAU OF OPERATIONS - OFFICE OF RECORDS

GENERAL PLANS	SPACECRAFT CLASS:	CLASS ONE KLINGON WARSHIP
MODEL:	TYPE:	NOMINAL CLASS:
CODE D MK-VIII	HEAVY BATTLECRUISER	K'T'INGA
GENERATED BY:	SCALE:	1:1366
MASTERCAM SFHQ		





STAR FLEET REFERENCE REPORT

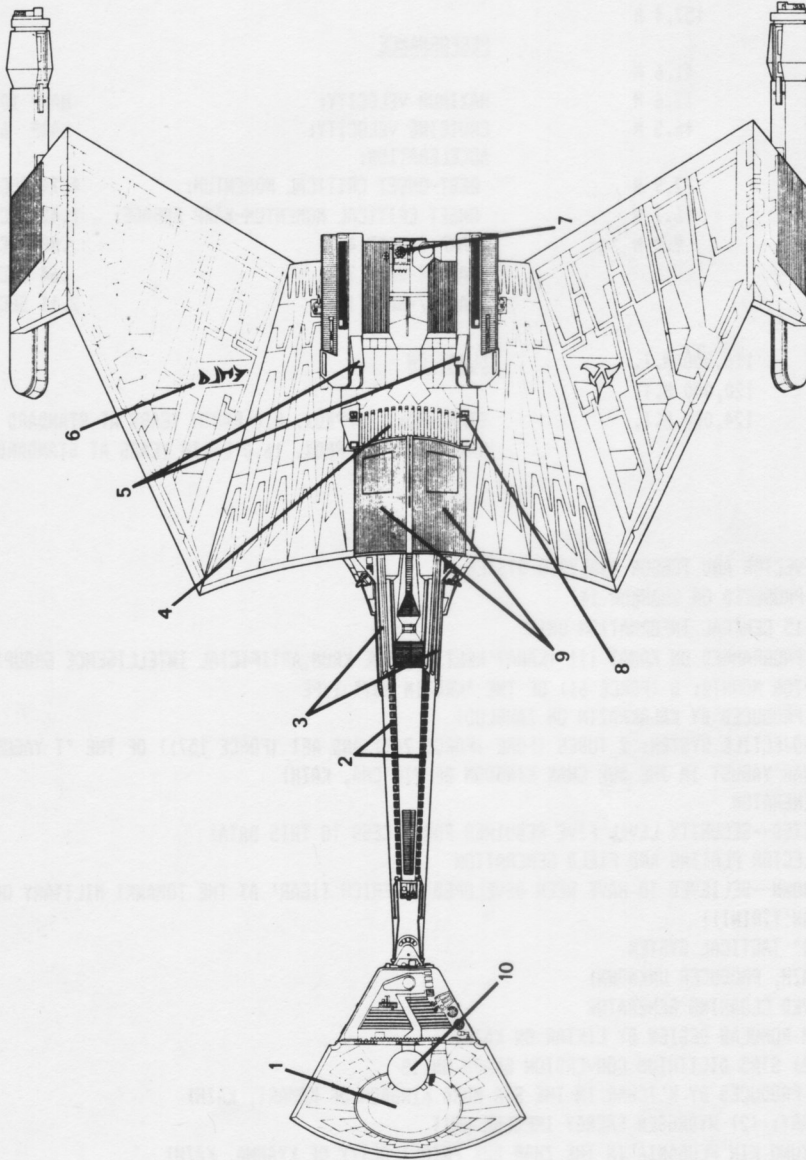

SUBFILE THREE: OUTBOARD TOP VIEW

RG:480371-2

TO:00:06:01:08.03

SPECIFICS:

- 1. BRIDGE
- 2. CLOAKING FIELD GENERATORS
- 3. REACTOR COOLING SYSTEM
- 4. MATTER INTAKE
- 5. RUNNING LIGHTS

- 6. NOMINAL I.D. FLIGHT DECK VENTING SYSTEM
- 7. SPACE ENERGY SENSOR-P/S
- 8. MAGNETIC ATTRACTOR PLATES
- 9. PRIMARY SENSOR ARRAY

UNITED FEDERATION OF PLANETS
 STAR FLEET DIVISION
 BUREAU OF OPERATIONS - OFFICE OF RECORDS

SPACECRAFT CLASS: CLASS ONE KLINGON WARSHIP	
MODEL: CODE D MK-VIII	NOMINAL CLASS: HEAVY BATTLECRUISER K'T'INGA
GENERATED BY: MASTERCOM SFHQ	

SCALE: 1:1366





KLINGON WARSHIP

CLASS ONE CODE D MK VIII SPECIFICATIONS

CURRENT SPECIFICATIONS OF K'T'INGA CLASS:

DIMENSIONS

OVERALL LENGTH: 214.3 M
 OVERALL DRAUGHT: 57.3 M
 OVERALL BEAM: 152.4 M

PRIMARY HULL LENGTH: 41.6 M
 PRIMARY HULL DRAUGHT: 32.6 M
 PRIMARY HULL BEAM: 46.5 M

NACELLE LENGTH: 72.9 M
 NACELLE DRAUGHT: 16.7 M
 NACELLE BEAM: 9.0 M

DISPLACEMENT

LIGHT: 116,000 M.T.
 STANDARD: 120,000 M.T.
 FULL LOAD: 124,000 M.T.

SHIP'S COMPLEMENT

OFFICERS: 10
 CREW: 375

PERFORMANCE

MAXIMUM VELOCITY: WARP 10
 CRUISING VELOCITY: WARP 6
 ACCELERATION:
 REST-ONSET CRITICAL MOMENTUM: 4.74 SEC
 ONSET CRITICAL MOMENTUM-WARP ENGAGE: 1.42 SEC
 WARP 1-WARP 4: .80 SEC
 WARP 4-WARP 7: .64 SEC
 WARP 7-WARP 10: 2.11 SEC

DURATION

STANDARD: APPROX. 8.0 EARTH YEARS AT STANDARD COMPLEMENT
 MAXIMUM: APPROX. 16.0 EARTH YEARS AT STANDARD COMPLEMENT

SYSTEMS

NAVIGATION: "DRUIM-BLINGE" VECTOR AND TENSOR ANALYSIS SYSTEM
 (DEVELOPED AND PRODUCED ON SHAHKUR IX)

COMPUTERS: "KU-TAN" LEVEL 15 CENTRAL INFORMATION UNIT
 (ASSEMBLED AND PROGRAMMED ON KAHAT III (KAHAT'KELT) BY THE KRUM ARTIFICIAL INTELLIGENCE GROUP)

WEAPONS: GRAVITIC DISRUPTOR MOUNTS: 8 (FORCE 61) OF THE "KRAZIN MOY" TYPE
 (DEVELOPED AND PRODUCED BY KALAKRAZIN ON ZAHGLUD)
 MAGNO-PHOTON PROJECTILE SYSTEM: 2 TUBES (FORE (FORCE 241) AND AFT (FORCE 157)) OF THE "T YAGUST" TYPE
 (PRODUCED BY CHAR'YAGUST IN THE BUR CHAK KINGDOM OF YIK'CHA, KAZH)
 STASIS FIELD GENERATOR
 (SPECIFICS DELETED--SECURITY LEVEL FIVE REQUIRED FOR ACCESS TO THIS DATA)

DEFENSE: "ZIGARMIT" DEFLECTOR PLATING AND FIELD GENERATION
 (SPECIFICS UNKNOWN--BELIEVED TO HAVE BEEN DEVELOPED BY FRICH TIGAR' AT THE TOMANKI MILITARY OUTPOST ON
 TOMAN IV (TOMAN'TIRINI))
 "KORTUK VWE-CHA" TACTICAL SYSTEM
 (PRODUCED ON KAZH, PRODUCER UNKNOWN)
 "KAEKUS" IMPROVED CLOAKING GENERATOR
 (DEVELOPED FROM ROMULAN DESIGN BY LIKTAR ON KAZH)

PROPULSION: HYPERPHOTIC: (2) STN5 DILITHIUM CONVERSION GRAPH UNITS
 (DEVELOPED AND PRODUCED BY K'TCHAR IN THE STA MURA KINGDOM OF KOMARI, KAZH)
 SUBPHOTIC PRIMARY: (2) HYDROGEN ENERGY IMPULSE UNIT
 (DEVELOPED BY KUNU KIN FLUGANZA IN THE ZHAN BUR PRINCIPALITY OF KYANNA, KAZH)
 MANUEVERING: "SECH'NAR" CHEMICAL PROPULSION SYSTEM
 (PRODUCED BY RAJIKS WU ON THE XONTARI SLAVE PLANET)

LIFE SUPPORT: ARTIFICIAL GRAVITY GENERATOR
 (FROM A CAPTURED TERRAN DESIGN, PROBABLY CRISTOBAL CT-3/CENTRIS)
 RADIATION PROTECTION SYSTEM
 (SPECIFICS UNKNOWN)
 "BAR'SHAK" WASTE REGENERATION AND SHIP'S MAINTENANCE SYSTEM
 (PRODUCED BY TRIN'SHAK ON SIF III (SIF'KELT))

RS: 480371.2

TO:00:06:01:08.09



KLINGON WARSHIP

CLASS ONE CODE D MK VIII UNDERSIDE DETAILS

K'T'INGA UNDERSIDE DETAILS:

PRIOR TO SD 6752.40, LITTLE WAS KNOWN ABOUT THE EXACT EXTERIOR CONFIGURATION OF K'T'INGA CLASS HEAVY BATTLECRUISERS. IN SIX PREVIOUS ENCOUNTERS DISTANCE OR OTHER CIRCUMSTANCES PREVENTED EXTENSIVE VISUAL RECONNOITERING. DURING THE KLINGON ENGAGEMENT OF THE V'GER SPACE PROBE HOWEVER, THE KLINGONS' PREOCCUPATION WITH THE BATTLE PERMITTED A SENSOR DRONE TO ACHIEVE A CLOSE APPROACH AND THUS GATHER MUCH NEW INFORMATION. DURING A PASS UNDER KL 98520 (AMAR), THIS HERETOFORE UNSEEN SIDE OF THE HEAVY BATTLECRUISER WAS OBSERVED.

AS THE VISUAL SCAN REPRODUCED ABOVE ILLUSTRATES, THE HEAVY DEFLECTOR PLATING OF THE SHIP'S UPPER SURFACES IS ALSO PRESENT ON THE UNDERSIDE. SIMILAR TO (BUT MUCH MORE POWERFUL THAN) THE DEFLECTOR GENERATING PLATES INSTALLED ON FEDERATION STARSHIPS PRIOR TO THE DEVELOPMENT OF DEFLECTOR GRIDS, THE MASSIVE PLATING HAS LITTLE IMPACT ON THE SHIPS' WARP DYNAMIC QUALITIES. THIS IS BECAUSE OF KLINGON ADVANCES IN WARPFIELD GENERATING CAPABILITIES THAT PERMIT COMPENSATION FOR IRREGULAR HULL SURFACES AT LOW POWER COST.

ALSO EVIDENT ARE ADDITIONAL GRAVITIC DISRUPTOR MOUNTS. IN ALL, THE K'T'INGAS ARE EQUIPPED WITH EIGHT SUCH MOUNTS, THUS QUADRUPILING THE NUMBER ON THE SIMILAR KLOLODE CLASS. THESE WEAPONS ARE ALSO EACH 30 PERCENT MORE POWERFUL THAN THOSE ON THE KLOLODES.

FOR FURTHER DETAILS ON THIS PART OF THE K'T'INGA CLASS HEAVY BATTLECRUISER SEE THE OUTBOARD BOTTOM VIEW GENERATED FROM THIS SCAN LOCATED AT T0:00:06:01:08:04.

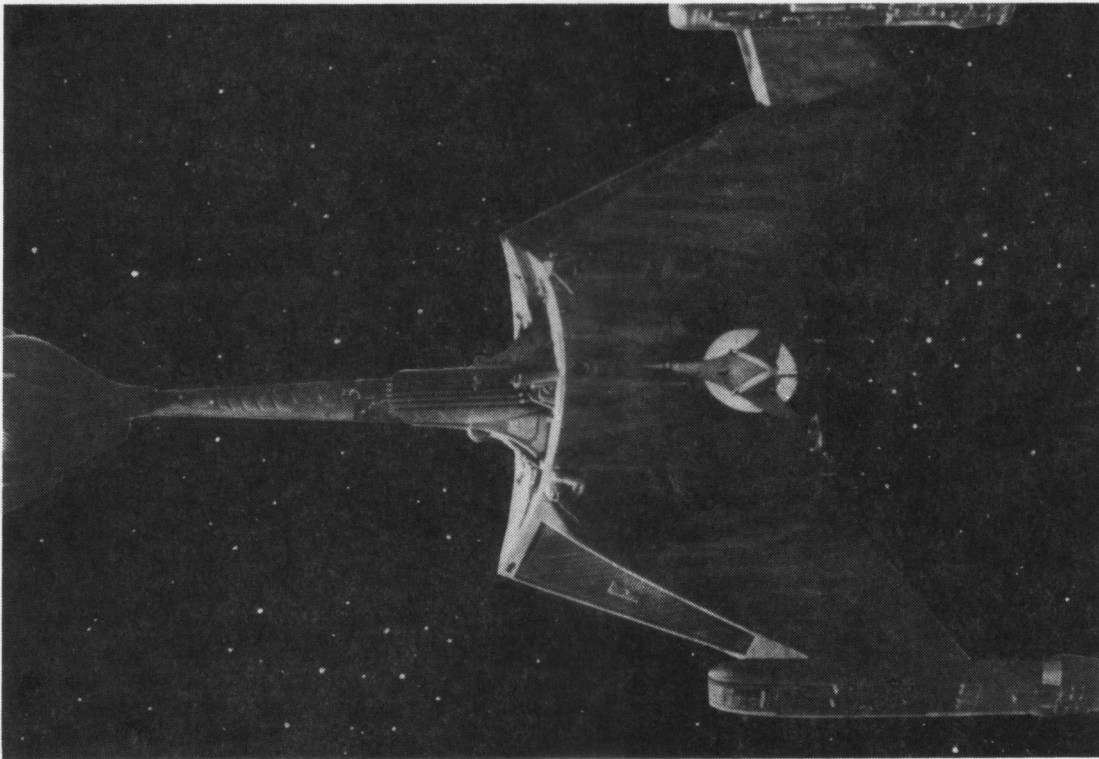

VISUAL SCAN TRANSMITTED FROM SENSOR DRONE LAUNCHED BY MONITOR STATION EPSILON NINE ON SD 6752.40 (BACKGROUND ADJUSTED TO ENHANCE CLARITY)

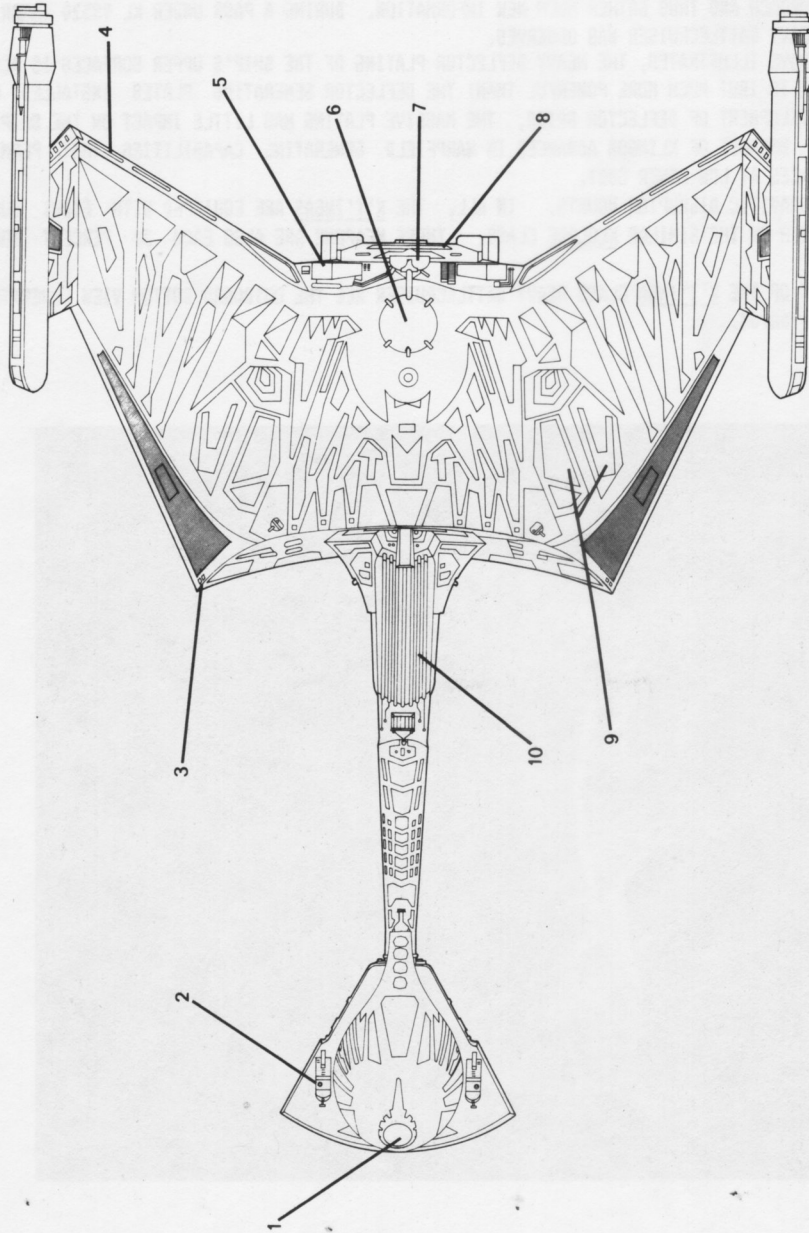

UNITED FEDERATION OF PLANETS
STAR FLEET DIVISION
BUREAU OF OPERATIONS - OFFICE OF RECORDS

GENERAL PLANS	SPACECRAFT CLASS: CLASS ONE KLINGON WARSHIP
MODEL: CODE D MK-VIII	NOMINAL CLASS: K'T'INGA
GENERATED BY: MASTERCOM SFHQ	SCALE: 1:1366

SUBFILE FOUR: OUTBOARD BOTTOM VIEW

RS: 480371-6

TD: 00:06:01:08.04

- SPECIFICS:
1. FORE TORPEDO TUBE
 2. PRIMARY DISRUPTOR-P/S
 3. HYDROGEN SENSOR-2 EACH P/S
 4. HYDROGEN BY-PASS VENTS-P/S
 5. IMPULSE PROPULSION HOUSING
 6. ANTIMATTER CONTAINMENT
 7. AFT TORPEDO TUBE
 8. FLIGHT DECK ACCESS DOORS
 9. REFLECTOR PLATES
 10. REFLECTOR SHIELD GENERATOR





KLINGON WARSHIP

CLASS ONE CODE D MK IX BACKGROUND & CLASS LISTING

BACKGROUND OF K'TEREMNY CLASS:

ON SD 7904.36 THE FEDERATION STARSHIP KNOX (NCC-1940) INTERCEPTED A CODED DISTRESS SIGNAL WHILE ON PATROL ALONG THE DISPUTED REGION OF FEDERATION-KLINGON BORDERSPACE. THE MESSAGE, WHICH ORIGINATED FROM A VESSEL IN KLINGON SPACE, WAS DIRECTED AT THE KLINGON CONSTRUCTION FACILITY IN THE KOHL STAR SYSTEM. IT INDICATED THAT A PROTOTYPE WARSHIP HAD DEVELOPED AN IMBALANCE IN ITS WARFIELD GENERATING CAPABILITIES WHILE ON TRIALS. THE RESULTING WORMHOLE HAD LEFT IT UNABLE TO MOVE OR NAVIGATE. KNOX IMMEDIATELY DISPATCHED TWO SURVEILLANCE DRONES TO EXAMINE THE STRICKEN VESSEL. WHAT THEY FOUND WAS SOMETHING STAR FLEET HAD BEEN EXPECTING--A NEW DESIGN OF KLINGON DESTROYER WHICH REPRESENTED A SUBSTANTIAL IMPROVEMENT OVER THE K'T'INGA CLASS OF HEAVY BATTLECRUISERS.

FOR A SHORT TIME THEREAFTER A NUMBER OF REPORTS WERE RECEIVED CONCERNING THE APPEARANCE OF VARIOUS DESTROYERS OF THIS K'TEREMNY CLASS. THEN, ON SD 8059.76 STARSHIP BRADLEY (NCC-2502) BECAME THE FIRST FEDERATION VESSEL TO COME FACE TO FACE WITH ONE OF THESE IMPRESSIVE WARSHIPS. THE SCIENTIFIC RESEARCH TEAM ON THE FOURTH PLANET OF UFC 24187 DISPATCHED AN URGENT HYPERLINK COMMUNIQUE TO BRADLEY STATING THAT LONG RANGE SENSORS HAD PICKED UP A KLINGON WARSHIP ENTERING FEDERATION SPACE AND HEADING FOR THEIR SYSTEM. BRADLEY ARRIVED AT THE PLANET ONLY SLIGHTLY AHEAD OF WHAT TURNED OUT TO BE THE K'TEREMNY CLASS DESTROYER RAGA. WHEN CONFRONTED, THE SHIP'S CAPTAIN LAID CLAIM TO THE PLANET IN THE NAME OF THE KLINGON EMPIRE. STAR FLEET HAD BEEN EXPECTING THIS MOVE HOWEVER, AS IT HAD BEEN KNOWN FOR SOME TIME THAT THE KLINGONS WERE VERY INTERESTED IN DUPLICATING THE GENETIC MAKEUP OF THE PLANET'S NATIVE SPECIES OF CHEST-BURSTING PARASITES. THUS, BRADLEY WAS WELL PREPARED FOR THE SUBSEQUENT BATTLE WITH RAGA. STILL, IT WAS ONLY WITH THE GREATEST EXERCISE OF SKILL THAT BRADLEY WAS ABLE TO DEFEAT THE POWERFUL WARSHIP, AND EVEN SO, THEY WERE UNABLE TO TAKE POSSESSION OF THEIR PRIZE BEFORE THE VESSEL SELF-DESTRUCTED.

THE ENCOUNTER BETWEEN BRADLEY AND RAGA DID PROVIDE STAR FLEET WITH MUCH VALUABLE DATA CONCERNING THE DESTROYER'S CAPABILITIES, HOWEVER. ITS BROAD SPECTRUM OF OFFENSIVE AND DEFENSIVE SYSTEMS, COMBINED WITH ITS LOW-MASS, WARP-DYNAMIC DESIGN AND INCREDIBLE ABILITY TO DROP FROM HYPERSPACE TO REALSPACE WITH PRACTICALLY NO BRAKING TIME MAKE IT AN EXTREMELY DANGEROUS OPPONENT IN EITHER WARP OR SUB-LIGHT COMBAT.

THIS WAS MADE EMINENTLY CLEAR IN THE PURSUIT OF THE DESTROYER QRISH (THE LION OF KAZH) BY FEDERATION STARSHIPS ACHILLES (NCC-551), AJAX (NCC-547) AND HOOD (NCC-1707) ON SD 8608.51-8608.54. STAR FLEET, UPON DISCOVERING THAT QRISH WAS MISSING FROM HER BASE IN THE SHAKUR STAR SYSTEM, SUSPECTED SHE WAS BENT ON COMMERCE-RAIDING OR WORSE, AND DISPATCHED A TASK FORCE TO FIND HER. DISCOVERING THE VESSEL BETWEEN BORDERSPACE AND DONATU, THE TASK FORCE GAVE IMMEDIATE CHASE. THE ENTERPRISE CLASS HEAVY CRUISER HOOD WAS DESTROYED IN THE ENSUING BATTLE, AND THE NEW DESTROYER AJAX WITHDREW BADLY MAULED. QRISH ESCAPED UNSCATHED.

LISTING OF KNOWN K'TEREMNY CLASS DESTROYERS:

NAME (TRANSLATION)	I.D. NUMBER	EXISTENCE VERIFIED	STATUS
DRELL (MIGHTY FLYING LIZARD)	KL 91499	SD 8333.64 BY EPSILON SEVEN STATION	ACTIVE
KOR'SACHEM (WARRIOR CHIEF)	KL 80336	SD 8090.29 BY <u>LEXINGTON</u> (NCC-1703)	ACTIVE
K'TEREMNY (GREAT SLAYER OF ENEMIES)	KL 44104	SD 7904.36 BY <u>KNOX</u> (NCC-1940)	ACTIVE
QRISH (THE LION OF KAZH)	KL 12550	SD 7938.29 BY <u>OBERON</u> (NCC-1880)	UNKNOWN
RAATID (ANGER)	KL 63606	SD 8186.47 BY <u>OPPORTUNE</u> (NCC-1946)	ACTIVE
RAGA (PASSION)	KL 14523	SD 8059.76 BY <u>BRADLEY</u> (NCC-2502)	DESTROYED
SABOG (FIRE BREATHING LIZARD)	KL 94598	SD 8110.42 BY EPSILON FOUR STATION	UNKNOWN
SAKAR (GOOD HUNTING)	KL 81949	SD 8268.43 BY <u>MINSK</u> (NCC-2525)	ACTIVE
SEERTEL (DETERMINATION)	KL 73742	SD 7976.02 BY EPSILON FOUR STATION	ACTIVE
SHARUG (FIRE WIND)	KL 49329	SD 8430.21 BY <u>ODIN</u> (NCC-1875)	UNKNOWN
TAKU' (ICE WIND)	KL 61196	SD 8367.28 BY SURVEILLANCE DRONE	ACTIVE
UU'WA (BEWARE)	KL 15474	SD 8497.61 BY <u>ESSAHIR</u> (NCC-2508)	ACTIVE
UNKNOWN	KL 94557	SD 8698.80 BY SURVEILLANCE DRONE	UNKNOWN
UNKNOWN	KL 42481	SD 7989.22 BY SURVEILLANCE DRONE	UNKNOWN
UNKNOWN	KL 23523	SD 8811.21 BY SURVEILLANCE DRONE	UNKNOWN

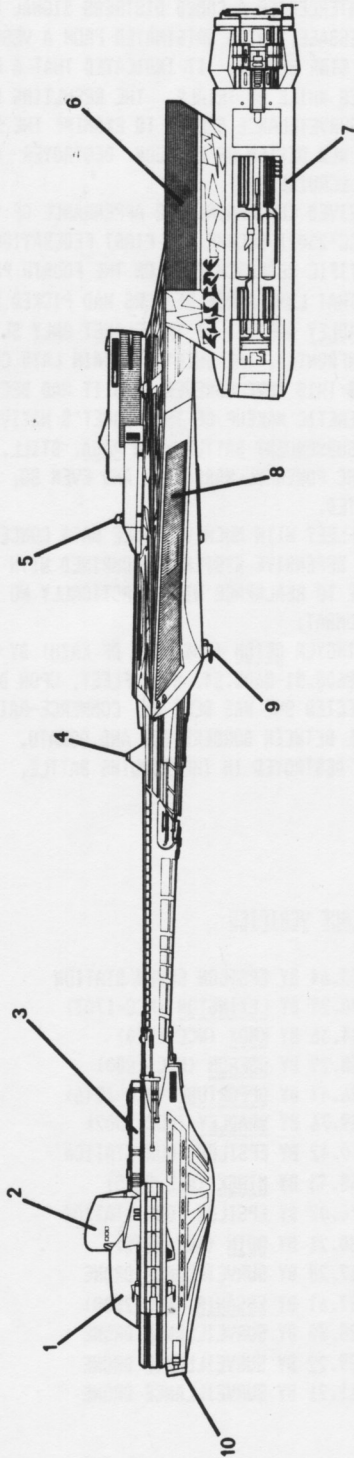

SUBFILE TWO: OUTBOARD PROFILE

RS: 480371-2
 TO: 00:06:01:09.02
 SPECIFICS:
 1. BRIDGE
 2. PRIMARY SENSOR ARRAY
 3. ENGINEERING SECTION
 4. NAVIGATIONAL BEACON-T/B
 5. SPACE ENERGY SENSOR-P/S
 6. EMERGENCY FLUSH VENT-P/S
 7. GRAPH UNIT-P/S
 8. HYDROGEN RAM INTAKE-P/S
 9. DISRUPTOR MOUNT (10)
 10. PHOTON TORPEDO TUBE (2)-F/A

UNITED FEDERATION OF PLANETS STAR FLEET DIVISION BUREAU OF OPERATIONS - OFFICE OF RECORDS	
GENERAL PLANS MODEL: CODE D MK-IX TYPE: DESTROYER GENERATED BY: MASTERCOM SFHQ	SPACECRAFT CLASS: CLASS ONE KLINGON WARSHIP NOMINAL CLASS: K'THERMNY SCALE: 1:1366





STAR FLEET REFERENCE REPORT

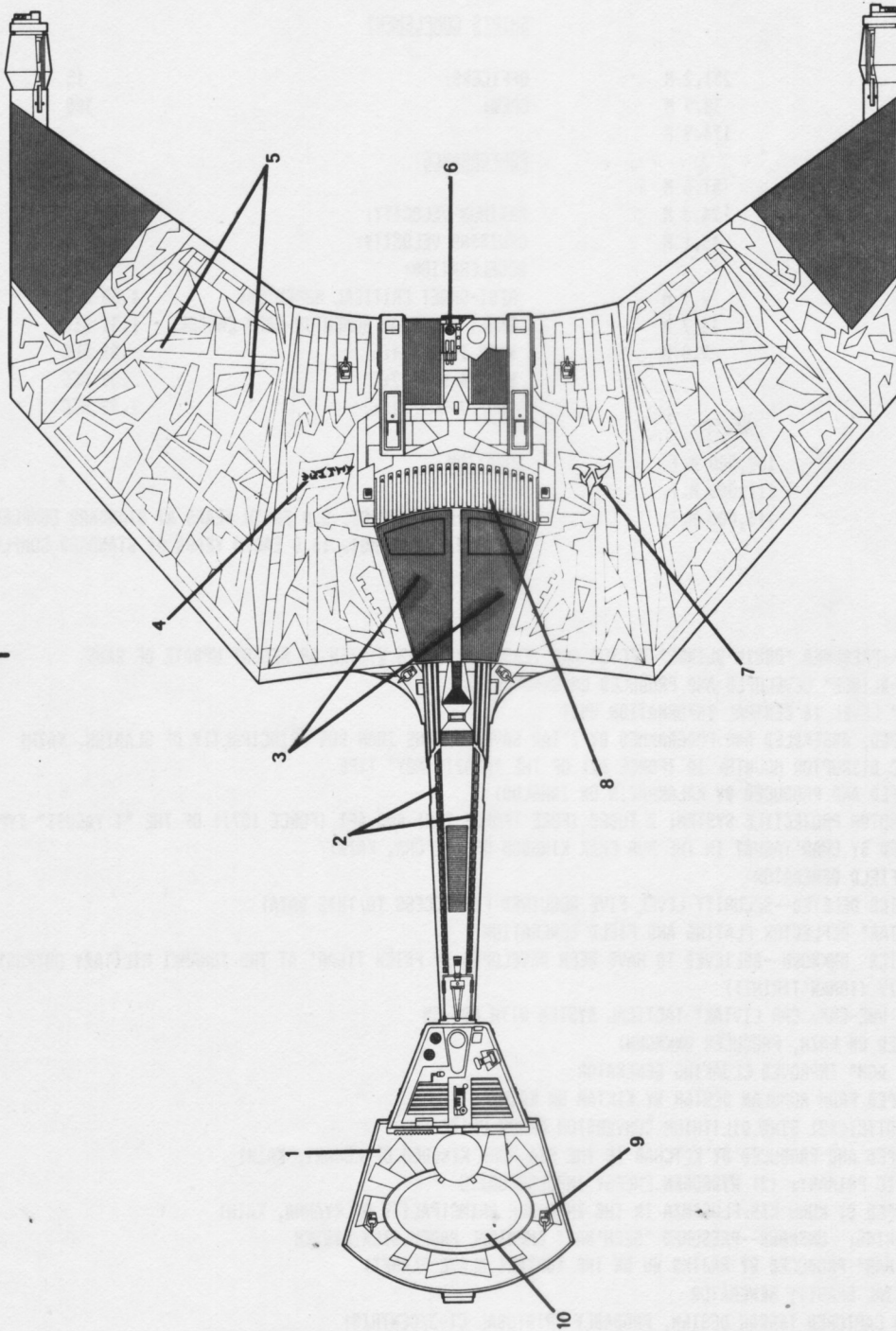

UNITED FEDERATION OF PLANETS
STAR FLEET DIVISION
 BUREAU OF OPERATIONS - OFFICE OF RECORDS

GENERAL PLANS		SPACECRAFT CLASS: CLASS ONE KLINGON WARSHIP	
MODEL: CODE D MK-IX	TYPE: DESTROYER	NOMINAL CLASS: K'THERNNY	
GENERATED BY: MASTERCOM SFHQ		SCALE: 1:1366	

SUBFILE THREE: OUTBOARD TOP VIEW

- TO:00:06:01:09.03
 SPECIFICS:
 1. FORECASTLE
 2. CLOAKING FIELD GENERATORS
 3. MAGNETIC ATTRACTOR PLATES
 4. NOMINAL I.D.
 5. DEFLECTOR PLATES
 6. FLIGHT DECK VENTING SYSTEM
 7. KLINGON FLEET EMBLEM
 8. MATTER INTAKE
 9. DISRUPTOR MOUNT (10)
 10. BRIDGE

RS:480371-2





KLINGON WARSHIP

CLASS ONE CODE D MK IX SPECIFICATIONS

CURRENT SPECIFICATIONS OF K'TEREMNY CLASS:

DIMENSIONS

OVERALL LENGTH: 251.2 M
 OVERALL DRAUGHT: 38.9 M
 OVERALL BEAM: 174.9 M

PRIMARY HULL LENGTH: 57.6 M
 PRIMARY HULL DRAUGHT: 24.3 M
 PRIMARY HULL BEAM: 45.1 M

NACELLE LENGTH: 72.9 M
 NACELLE DRAUGHT: 16.7 M
 NACELLE BEAM: 9.0 M

DISPLACEMENT

LIGHT: 109,000 M.T.
 STANDARD: 111,000 M.T.
 FULL LOAD: 113,000 M.T.

SHIP'S COMPLEMENT

OFFICERS: 15
 CREW: 380

PERFORMANCE

MAXIMUM VELOCITY: WARP 11
 CRUISING VELOCITY: WARP 7
 ACCELERATION:
 REST-ONSET CRITICAL MOMENTUM: 4.38 SEC
 ONSET CRITICAL MOMENTUM-WARP ENGAGE: 1.31 SEC
 WARP 1-WARP 4: .51 SEC
 WARP 4-WARP 7: .59 SEC
 WARP 7-WARP 11: 1.99 SEC

DURATION

STANDARD: APPROX. 8.0 EARTH YEARS AT STANDARD COMPLEMENT
 MAXIMUM: APPROX. 16.0 EARTH YEARS AT STANDARD COMPLEMENT

SYSTEMS

NAVIGATION: UNKNOWN--PRESUMED "DRUIM-BLINGE" VECTOR AND TENSOR ANALYSIS SYSTEM OR RECENT UPDATE OF SAME ("DRUIM-BLINGE" DEVELOPED AND PRODUCED ON SHANKUR IX)

COMPUTERS: "AKAMAI" LEVEL 16 CENTRAL INFORMATION UNIT (DEVELOPED, ASSEMBLED AND PROGRAMMED BY Z'TAR GAVNA IN THE ZHAN BUR PRINCIPALITY OF GLADISH, KAZH)

WEAPONS: GRAVITIC DISRUPTOR MOUNTS: 10 (FORCE 61) OF THE "KRAZIN MOY" TYPE (DEVELOPED AND PRODUCED BY KALAKRAZIN ON ZAGHLUD)
 MAGNO-PHOTON PROJECTILE SYSTEM: 2 TUBES (FORE (FORCE 248) AND AFT (FORCE 157)) OF THE "T YAGUST" TYPE (PRODUCED BY CHAR'YAGUST IN THE BUR CHAK KINGDOM OF YIK'CHA, KAZH)
 STASIS FIELD GENERATOR (SPECIFICS DELETED--SECURITY LEVEL FIVE REQUIRED FOR ACCESS TO THIS DATA)

DEFENSE: "ZIGARKTAR" DEFLECTOR PLATING AND FIELD GENERATION (SPECIFICS UNKNOWN--BELIEVED TO HAVE BEEN DEVELOPED BY FRICH TIGAR' AT THE TOMANKI MILITARY OUTPOST ON TOMAN IV (TOMAN'TIRINI))
 "KORTUK VWE-CHA, CAR LIVTAK" TACTICAL SYSTEM WITH ADD-ON (PRODUCED ON KAZH, PRODUCER UNKNOWN)
 "KAEKUS DOM" IMPROVED CLOAKING GENERATOR (DEVELOPED FROM ROMULAN DESIGN BY KIKTAR ON KAZH)

PROPULSION: HYPERPHOTIC: (2) STNS DILITHIUM CONVERSION GRAPH UNITS (DEVELOPED AND PRODUCED BY K'TCHAR IN THE STA MURA KINGDOM OF KOMARI, KAZH)
 SUBPHOTIC PRIMARY: (2) HYDROGEN ENERGY IMPULSE UNITS (DEVELOPED BY KUNU KIN FLUGANZA IN THE ZHAN BUR PRINCIPALITY OF KYANNA, KAZH)
 MANUEVERING: UNKNOWN--PRESUMED "SECH'NAR" CHEMICAL PROPULSION SYSTEM ("SECH'NAR" PRODUCED BY RAJIKS WU ON THE XONTARI SLAVE PLANET)

LIFE SUPPORT: ARTIFICIAL GRAVITY GENERATOR (FROM A CAPTURED TERRAN DESIGN, PROBABLY CRISTOBAL CT-3/CENTRIS)
 RADIATION PROTECTION SYSTEM (SPECIFICS UNKNOWN)
 "BAR'SHAK" WASTE REGENERATION AND SHIP'S MAINTENANCE SYSTEM (PRODUCED BY TRIN'SHAK ON SIF III (SIF'KELT))

RS: 480371.2

TO:00:06:01:09.09



SPACE OFFICE COMPLEX

ARTIST'S CONCEPTION-PROFILE

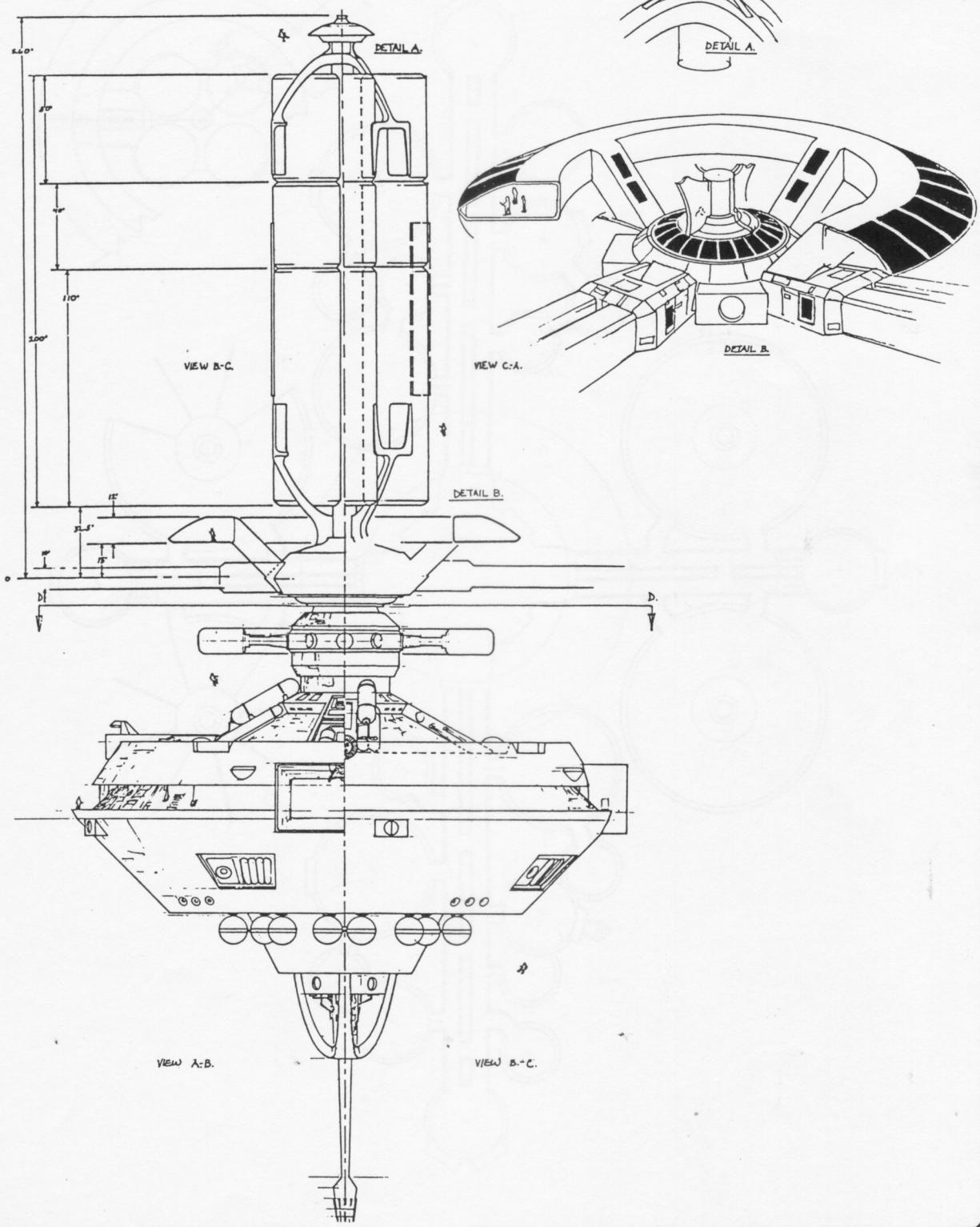

RS: 480371.4

TO: 01:01:30:57.02



SPACE OFFICE COMPLEX

ARTIST'S CONCEPTION-TOP VIEW

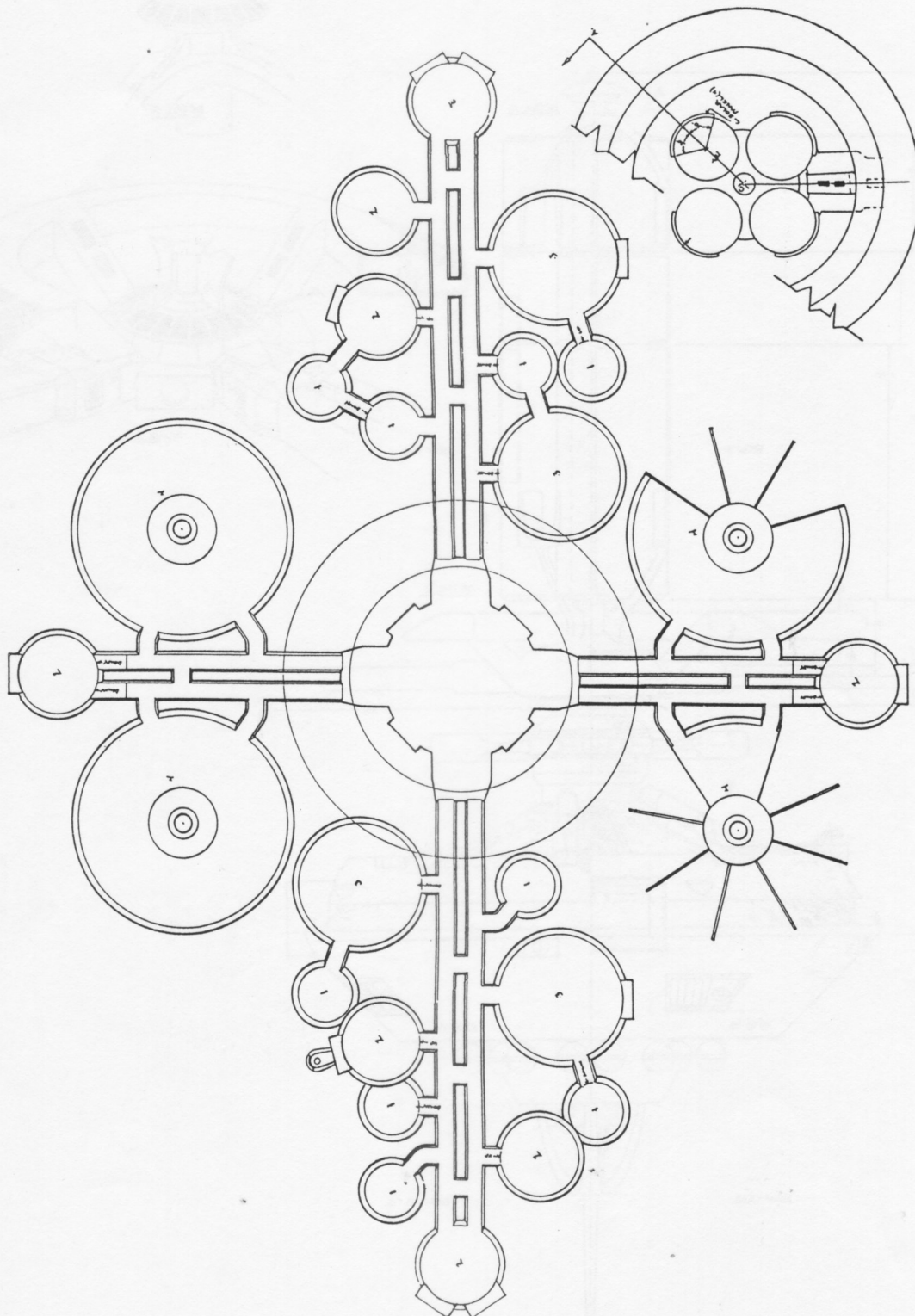

RS: 480371.4

TO: 01:01:30:57.03



SPACE OFFICE COMPLEX

ARTIST'S CONCEPTION-EXTERIOR VIEWS

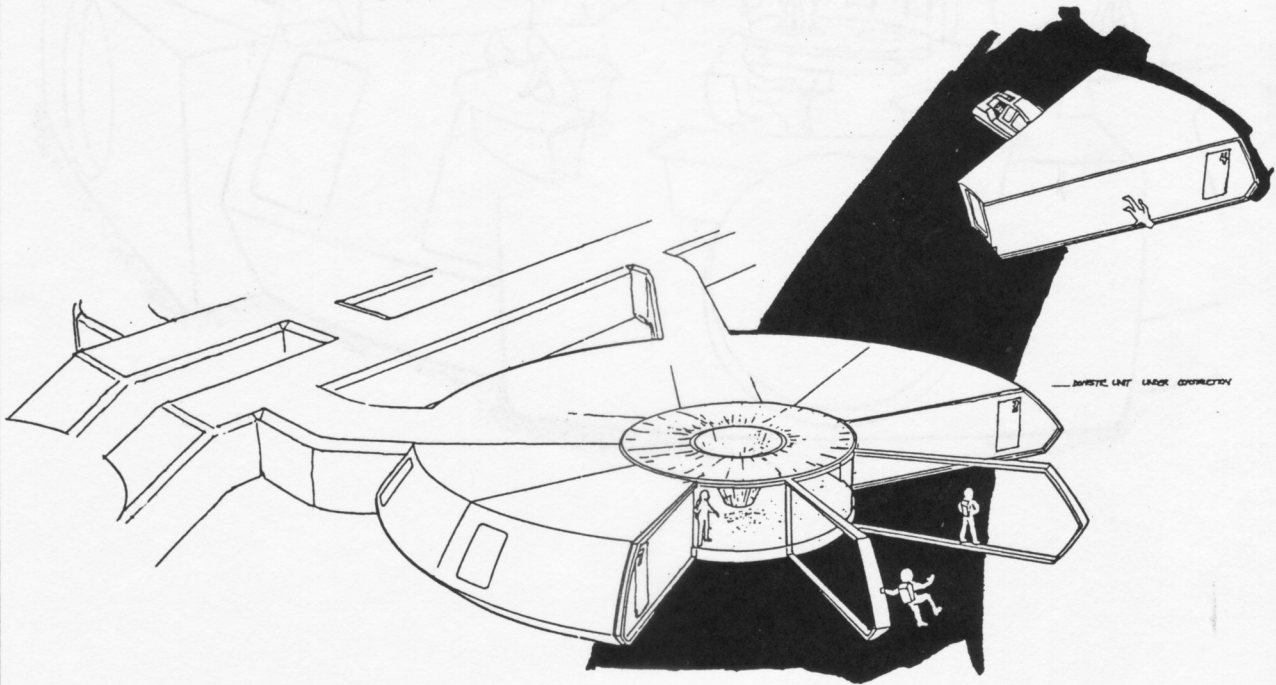
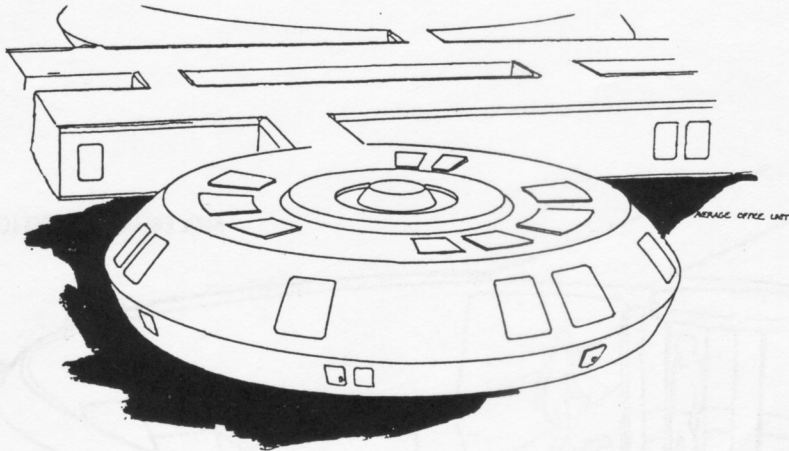

SECTIONS BECOME PRESSURIZED WHEN IN PLACE

RS: 480371.4

TO: 01:01:30:57.06



SPACE OFFICE COMPLEX

ARTIST'S CONCEPTION-INTERIOR VIEW

RS: 480371.4

TO: 01:01:30:57.07

MAIN ENGINEERING OFFICE

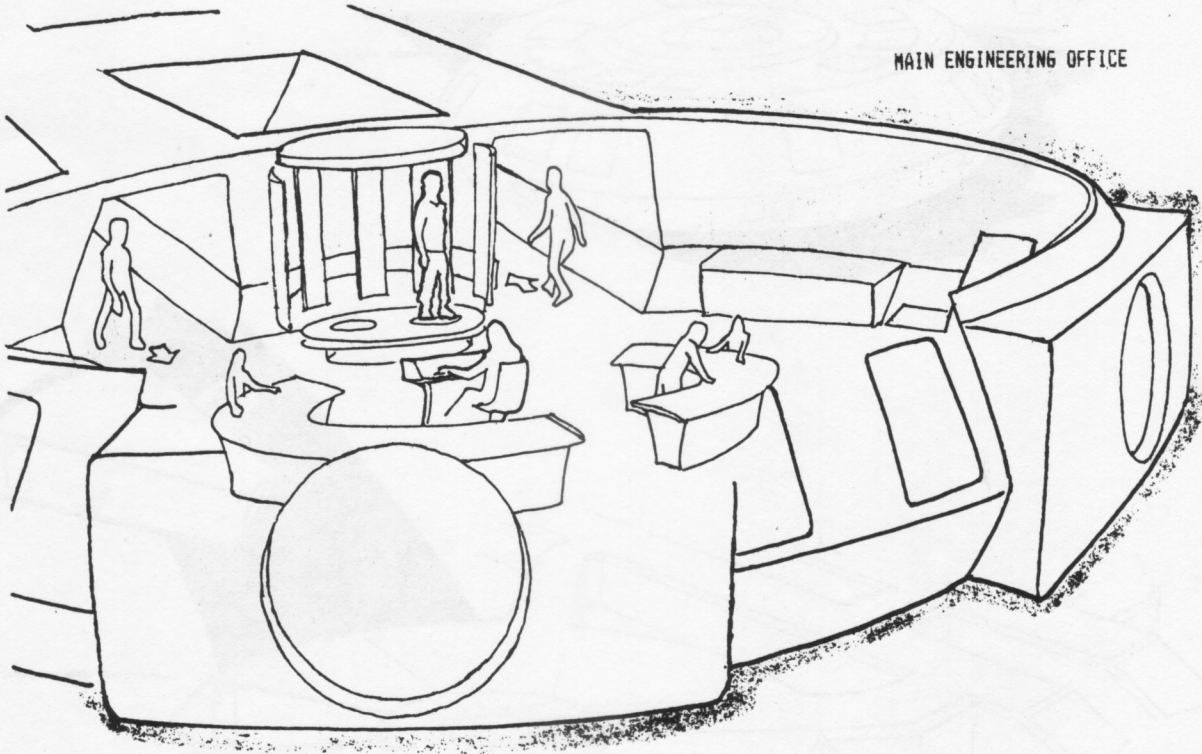



ADMINISTRATIVE ORDER

INSTITUTION OF NON-COMMISSIONED RATINGS

I. HENCEFORTH, THE STAR FLEET DIVISION OF THE UNITED FEDERATION OF PLANETS WILL INSTALL, AS A MEANS OF PERSONNEL GRADATION, NON-COMMISSIONED ENLISTEES, RATED AS FOLLOWS:

II. STAR FLEET ENLISTED RATINGS:

- A. CREWMAN ENLISTEE
- B. CREWMAN APPRENTICE
- C. CREWMAN
- D. PETTY OFFICER, THIRD CLASS
- E. PETTY OFFICER, SECOND CLASS
- F. PETTY OFFICER, FIRST CLASS
- G. CHIEF PETTY OFFICER

III. STAR FLEET PETTY OFFICER SPECIALIST GROUPS:

- A. DECK GROUP
 - 1. MAINTENANCE
 - 2. DAMAGE CONTROL
 - 3. NAVIGATION
 - 4. HELM
 - 5. FLIGHT
 - 6. ORDNANCE
 - 7. YEOMANRY
 - 8. AUXILIARY OPERATIONS
- B. SHIP'S SERVICES GROUP
 - 1. ENGINEERING
 - 2. TRANSPORTER
 - 3. CONSTRUCTION
 - 4. SECURITY
 - 5. SUPPLY
 - 6. COMMUNICATIONS
 - 7. YEOMANRY
 - 8. AUXILIARY OPERATIONS
- C. SCIENCES GROUP
 - 1. PHYSICAL
 - 2. MEDICAL
 - 3. BIOLOGICAL
 - 4. CHEMICAL
 - 5. SOCIAL
 - 6. TECHNICAL
 - 7. YEOMANRY
 - 8. AUXILIARY OPERATIONS

RS: 480371.6

TO: 01:02:00:56.01



ADMINISTRATIVE ORDER

STAR FLEET DIVISION-REORGANIZATION

I. SO ORDERED, THAT AS OF THIS STARDATE, THE FOLLOWING REORGANIZATION OF STAR FLEET DIVISION WILL TAKE EFFECT:

THE STAR FLEET DIVISION SHALL HENCEFORTH BE COMPOSED OF FOUR BRANCHES:

- A. STAR FLEET CIVILIAN AUTHORITY
- B. STAR FLEET COMMAND
- C. STAR FLEET OPERATING FORCES
- D. STAR FLEET SHORE ESTABLISHMENT

II. STAR FLEET CIVILIAN AUTHORITY

- A. THE STAR FLEET CIVILIAN AUTHORITY SHALL BE THE ULTIMATE AUTHORITY OF THE STAR FLEET DIVISION. IT WILL BE COMPOSED OF THE FEDERATION COUNCIL, ACTING THROUGH THE OFFICE OF THE FEDERATION COMMISSIONER OF STAR FLEET AND THE OFFICES OF THE CIVILIAN EXECUTIVE ASSISTANTS.
- B. THE STAR FLEET CIVILIAN AUTHORITY SHALL INCLUDE THE TOP CIVILIAN EXECUTIVES OF STAR FLEET. THESE ARE:
 - 1. THE FEDERATION COMMISSIONER OF STAR FLEET
 - 2. THE FEDERATION DEPUTY-COMMISSIONER OF STAR FLEET
 - 3. THE ASSISTANT COMMISSIONERS, WHO WILL VARY ACCORDING TO LAW AND THE DUTIES DELEGATED TO THEM.
- C. THE STAR FLEET CIVILIAN AUTHORITY SHALL BE HEADQUARTERED IN THE CITY OF SAN FRANCISCO ON THE PLANET EARTH, SOL SYSTEM.

III. STAR FLEET COMMAND

- A. STAR FLEET COMMAND SHALL BE THE MILITARY AUTHORITY OF THE STAR FLEET DIVISION. IT WILL BE COMPOSED OF THE OFFICE OF THE CHIEF OF STAR FLEET COMMAND, THE BUREAUS AND OFFICES HEADED BY THE TECHNICAL ASSISTANTS, AND THE HEADQUARTERS OF THE MOBILE GROUND FORCE.
- B. STAR FLEET COMMAND SHALL INCLUDE THE TOP PROFESSIONAL EXECUTIVES OF STAR FLEET. THESE ARE:
 - 1. THE CHIEF OF STAR FLEET COMMAND
 - 2. THE VICE-CHIEF OF STAR FLEET COMMAND
 - 3. THE DIRECTORS OF THE BUREAU OF OPERATIONS
 - 4. THE CHIEFS OF THE OTHER BUREAUS, WHO, ALONG WITH THE DIRECTORS OF THE BUREAU OF OPERATIONS, WILL BE KNOWN AS TECHNICAL ASSISTANTS TO THE CHIEF OF STAR FLEET COMMAND.
- C. STAR FLEET COMMAND BUREAUS AND COMMANDING OFFICER ORGANIZATION SHALL BE ARRANGED IN THE FOLLOWING MANNER:
 - 1. CHIEF OF STAR FLEET COMMAND
THIS OFFICER SHALL HOLD THE RANK OF FLEET ADMIRAL AND SHALL BE THE SENIOR OFFICER OF THE STAR FLEET DIVISION UNDER AUTHORITY OF THE FEDERATION COUNCIL AND THE FEDERATION COMMISSIONER OF STAR FLEET. HE/SHE SHALL BE THE STAR FLEET COMMAND ASSISTANT TO THE FEDERATION COMMISSIONER OF STAR FLEET, AND WILL BE RESPONSIBLE FOR THE MILITARY AUTHORITY OF THE STAR FLEET DIVISION.
 - 2. VICE-CHIEF OF STAR FLEET COMMAND
THIS OFFICER SHALL HOLD THE MINIMUM RANK OF ADMIRAL AND WILL ACT AS CHIEF OF OPERATIONS. HE/SHE SHALL BE THE FIRST ASSISTANT TO THE CHIEF OF STAR FLEET COMMAND, AND THE SECOND RANKING OFFICER OF THE STAR FLEET DIVISION.
 - a. DIRECTOR OF OPERATIONS
THIS OFFICER SHALL HOLD THE MINIMUM RANK OF REAR ADMIRAL OF THE LINE AND WILL HAVE AUTHORITY OVER THE OFFICE OF OPERATIONS OF THE BUREAU OF OPERATIONS AND THE STAR FLEET OPERATING FORCES, AND WILL BE COMMANDER OF DEFENSE.
 - b. DIRECTOR OF ADMINISTRATION
THIS OFFICER SHALL HOLD THE MINIMUM RANK OF REAR ADMIRAL OF THE LINE AND WILL HAVE AUTHORITY OVER THE OFFICE OF ADMINISTRATION OF THE BUREAU OF OPERATIONS. AS SUCH, HE/SHE WILL SEE TO THE EXECUTION OF THE ADMINISTRATIVE RULES AND REGULATIONS ORDERED BY STAR FLEET COMMAND.
 - c. DIRECTOR OF LOGISTICS
THIS OFFICER SHALL HOLD THE MINIMUM RANK OF REAR ADMIRAL OF THE SUPPLY CORPS AND WILL HAVE AUTHORITY OVER THE OFFICE OF LOGISTICS OF THE BUREAU OF OPERATIONS. HE/SHE SHALL HAVE CHARGE OF THE PURCHASE, RECEPTION, FABRICATION, STORAGE, CARE, CUSTODY, TRANSFER, SHIPMENT, ISSUE, AND ACCOUNTING FOR ALL SUPPLIES AND PROPERTY OF STAR FLEET, EXCEPT MEDICAL SUPPLIES (BUT INCLUDING THEIR PURCHASE) AND SUPPLIES FOR THE MOBILE GROUND FORCE.

RS: 480371.3

TO: 01:02:00:73.01



ADMINISTRATIVE ORDER

STAR FLEET DIVISION-REORGANIZATION

- d. DIRECTOR OF STRATEGY
THIS OFFICER SHALL HOLD THE MINIMUM RANK OF REAR ADMIRAL OF THE LINE AND WILL HAVE AUTHORITY OVER THE OFFICE OF STRATEGY OF THE BUREAU OF OPERATIONS. HE/SHE WILL BE RESPONSIBLE FOR THE PLANNING AND DIRECTION OF LARGE-SCALE MILITARY OPERATIONS AND LONG-RANGE MILITARY PLANNING INVOLVING THE ARMED FORCES OF THE STAR FLEET DIVISION.
- e. DIRECTOR OF PERSONNEL
THIS OFFICER SHALL HOLD THE MINIMUM RANK OF REAR ADMIRAL OF THE LINE AND WILL HAVE AUTHORITY OVER THE OFFICE OF PERSONNEL OF THE BUREAU OF OPERATIONS. HE/SHE SHALL BE CHARGED WITH AND RESPONSIBLE FOR THE RECRUITMENT, EDUCATION, TRAINING, DISCIPLINE, AND ASSIGNMENT OF COMMISSIONED OFFICERS AND ENLISTED PERSONNEL OF STAR FLEET (EXCEPT FOR THE PROFESSIONAL EDUCATION OF COMMISSIONED OFFICERS AND ENLISTED PERSONNEL OF THE MEDICAL DEPARTMENT).
3. CHIEF OF SHORE ESTABLISHMENTS
THIS OFFICER SHALL HOLD THE MINIMUM RANK OF EITHER REAR ADMIRAL OF THE LINE OR OF THE CORPS OF ENGINEERS AND SHALL HAVE CHARGE OF THE BUREAU OF SHORE ESTABLISHMENTS AND THE STAR FLEET SHORE ESTABLISHMENT. AS SUCH, HE/SHE SHALL BE RESPONSIBLE FOR THE DESIGN, REPAIR, UPKEEP, AND OPERATION OF ALL STATIONARY INSTALLATIONS, PUBLIC WORKS, AND PUBLIC UTILITIES OF STAR FLEET.
4. CHIEF OF INTELLIGENCE
THIS OFFICER SHALL HOLD THE MINIMUM RANK OF REAR ADMIRAL OF THE LINE AND SHALL HAVE CHARGE OF THE BUREAU OF INTELLIGENCE. HE/SHE SHALL BE RESPONSIBLE FOR THE GATHERING AND INTERPRETATION OF INTELLIGENCE, AND FOR OPERATIONS SUPPORTIVE OF THESE TASKS.
5. COMMANDANT OF THE MOBILE GROUND FORCE
THIS OFFICER SHALL HOLD THE MINIMUM RANK OF MAJOR GENERAL OF THE MOBILE GROUND FORCE AND SHALL HAVE CHARGE OF THE GENERAL EFFICIENCY AND DISCIPLINE OF THAT FORCE.
6. CHIEF OF SPACECRAFT
THIS OFFICER SHALL HOLD THE MINIMUM RANK OF REAR ADMIRAL OF THE LINE (ASSIGNED FOR ENGINEERING DUTY ONLY) AND SHALL HAVE CHARGE OF THE BUREAU OF SPACECRAFT. AS SUCH, HE SHALL BE RESPONSIBLE FOR THE STRENGTH, STABILITY, DESIGNING, BUILDING, FITTING, REFITTING, AND REPAIRING OF ALL PARTS OF STAR FLEET SPACECRAFT, EXCEPT SUCH PARTS AS PERTAIN TO ORDNANCE AND MEDICINE.
7. CHIEF OF ORDNANCE
THIS OFFICER SHALL HOLD THE MINIMUM RANK OF REAR ADMIRAL OF THE LINE AND SHALL HAVE CHARGE OF THE BUREAU OF ORDNANCE. HE/SHE SHALL BE RESPONSIBLE FOR THE UPKEEP AND OPERATION OF ALL ORDNANCE ESTABLISHMENTS SUCH AS MAGAZINES, MUNITIONS AREAS, WEAPONS FABRICATORS, PHOTON TORPEDO STATIONS, PHASER STATIONS, INTERSTELLAR, SYSTEMIC, AND PLANETARY PROVING GROUNDS, ETC.; FOR RESEARCH, DEVELOPMENT, AND MANUFACTURE OF ARMS, ARMOR, AND EXPLOSIVE WEAPONRY; FOR RESEARCH, DEVELOPMENT, AND MANUFACTURE OF DEFENSE SYSTEMS AND FOR THEIR UPKEEP; AND FOR REPAIR AND UPKEEP OF ORDNANCE EQUIPMENT ABOARD SHIP.
8. CHIEF OF SCIENTIFIC RESEARCH AND EXPLORATION
THIS OFFICER SHALL HOLD THE MINIMUM RANK OF EITHER REAR ADMIRAL OF THE LINE OR OF THE SCIENCES AND SHALL HAVE CHARGE OF THE BUREAU OF SCIENTIFIC RESEARCH AND EXPLORATION. HE/SHE SHALL BE RESPONSIBLE FOR THE CONDUCT OF THOSE OPERATIONS DEALING WITH SCIENTIFIC ACTIVITY, INCLUDING BUT NOT NECESSARILY RESTRICTED TO THE PHYSICAL, CHEMICAL, BIOLOGICAL, TECHNICAL, OR SOCIAL SCIENCES, AS WELL AS MAPPING; AND SHALL BE COMMANDER OF EXPLORATION.
9. SURGEON GENERAL
THIS OFFICER SHALL HOLD THE MINIMUM RANK OF REAR ADMIRAL OF THE MEDICAL CORPS AND SHALL HAVE CHARGE OF THE BUREAU OF MEDICINE. HE/SHE SHALL HAVE RESPONSIBILITY FOR THE UPKEEP AND OPERATION OF ALL HOSPITALS AND THE FORCES STATIONED THEREIN; FOR THE CARE OF THE SICK AND INJURED; FOR THE PHYSICAL AND PSYCHOLOGICAL EXAMINATION OF STAR FLEET PERSONNEL; FOR THE TRAINING, PROMOTION, ETC. OF THE MEDICAL CORPS; AND FOR THE SUPPLY OF ALL MEDICAL AND DENTAL EQUIPMENT TO STAR FLEET.
10. JUDGE ADVOCATE GENERAL
THIS OFFICER SHALL HOLD THE MINIMUM RANK OF REAR ADMIRAL OF THE LINE AND SHALL HAVE CHARGE OF THE BUREAU OF JUSTICE. HE/SHE SHALL ALSO BE CHARGED, UNDER THE REGULATIONS CREATING THE OFFICE, WITH ALL MATTERS OF LAW ARISING IN STAR FLEET, INCLUDING THE PREPARATION OF CHARGES AND SPECIFICATIONS FOR GENERAL COURTS MARTIAL CONVENED BY THE CHIEF OF STAR FLEET COMMAND, AND THE REVIEW OF THE RECORDS OF PROCEEDINGS OF ALL COURTS MARTIAL, DECK COURTS, COURTS OF INQUIRY, AND BOARDS OF INVESTIGATION; AND SHALL BE COMMANDER OF ENFORCEMENT.

RB: 480371.3

TO: 01:02:00:73.02

AMENDMENT CODE:REV05

AUTHENTICATED STARDATE 7912.07



ADMINISTRATIVE ORDER

STAR FLEET DIVISION-REORGANIZATION

IV. STAR FLEET OPERATING FORCES

- A. THE STAR FLEET OPERATING FORCES SHALL BE DESIGNATED AS THOSE FLEETS, SPACEGOING FORCES, PLANETARY FRONTIER FORCES, DISTRICT FORCES, AND OTHER INTERSTELLAR, SYSTEMIC, AND PLANETARY DIVISIONS WHICH MAY BE ASSIGNED TO THE AUTHORITY OF THE FEDERATION COMMISSIONER OF STAR FLEET AND THE CHIEF OF STAR FLEET COMMAND. THE OPERATING FORCES SHALL ACT AS THE MILITARY, EXPLORATORY, AND COLONIZATION ARM OF THE UNITED FEDERATION OF PLANETS.
- B. THE DIRECTOR OF OPERATIONS, UNDER THE SUPERVISION OF THE VICE-CHIEF OF STAR FLEET COMMAND (ACTING AS CHIEF OF OPERATIONS), SHALL DIRECT THE STAR FLEET OPERATING FORCES, AND SHALL BE RESPONSIBLE FOR THE PREPARATION AND READINESS OF PLANS FOR THEIR USE.
- C. THE STAR FLEET OPERATING FORCES SHALL BE SUBDIVIDED AND ORGANIZED IN THE FOLLOWING MANNER:
 1. FLEET
A FLEET SHALL BE AN ORGANIZATION OF STARSHIPS AND SPACECRAFT UNDER ONE COMMANDER, AND SHALL NORMALLY COMPRISE ALL TYPES OF SUCH CRAFT NECESSARY FOR MAJOR OPERATIONS. FEDERATION TREATY SPACE IS DIVIDED INTO NINE SUBQUADRANTS, AND EACH SHALL HAVE A FLEET ASSIGNED TO IT. THE TITLE OF "COMMANDER-IN-CHIEF" WILL BE GIVEN TO THE OFFICER, NORMALLY A REAR ADMIRAL, WHO IS PLACED IN COMMAND OF A FLEET BY ORDER OF THE DIRECTOR OF OPERATIONS.
 2. FORCE
A FORCE SHALL BE A MAJOR SUBDIVISION OF A FLEET, AND WILL NORMALLY BE COMMANDED BY A REAR ADMIRAL.
 3. TASK FORCE
A TASK FORCE SHALL BE ANY FORCE THAT HAS BEEN ORGANIZED TO ACCOMPLISH A SPECIAL TASK. GIVEN EXTRAORDINARY CIRCUMSTANCES WHERE A REAR ADMIRAL SHALL BE UNAVAILABLE, AN OFFICER OF LOWER FLAG RANK MAY BE GIVEN TASK FORCE COMMAND.
 4. TASK GROUP, TASK ELEMENT, TASK UNIT
TASK GROUPS, TASK ELEMENTS, AND TASK UNITS SHALL BE SUBDIVISIONS OF A TASK FORCE ORGANIZED TO CARRY OUT SPECIFIC ASSIGNMENTS.
 5. DIVISION
THE DIVISION SHALL BE THE BASIC UNIT OF FLEET STARSHIPS, AND SHALL BE COMPOSED OF TWO OR MORE STARSHIPS OF THE SAME TYPE. A DIVISION MAY BE COMMANDED BY ANY QUALIFIED STARSHIP COMMANDER.
 6. SQUADRON
TWO OR MORE DIVISIONS OF VESSELS SHALL MAKE UP A SQUADRON. ORDINARILY, A SQUADRON WILL BE COMPOSED OF STARSHIPS OF THE SAME TYPE, BUT AT TIMES IT MIGHT BE DERIVED FROM DIVISIONS OF DIVERSE CRAFT. AT TIMES, TOO, A SQUADRON MIGHT BE A SEPARATE ORGANIZATION WHOSE COMMANDER WILL OPERATE DIRECTLY UNDER ORDERS FROM STAR FLEET COMMAND. SQUADRONS MAY BE COMMANDED BY AN OFFICER OF THE RANK COMMODORE OR ABOVE.
 7. UNIT
TWO OR MORE SQUADRONS OF LIGHT STARSHIPS SHALL COMPRISE A UNIT. A UNIT MAY HAVE A FLAGSHIP, TENDERS, AND OTHER SUPPORT SPACECRAFT ASSIGNED TO IT. UNITS MAY BE COMMANDED BY AN OFFICER OF THE RANK COMMODORE OR ABOVE.
 8. TYPE ORGANIZATION
A SUBDIVISION OF A FLEET OR FORCE INTO STARSHIPS OF THE SAME TYPE SHALL BE TERMED A TYPE ORGANIZATION. ANY TYPE ORGANIZATION MAY HAVE A FLAGSHIP, TENDERS, AND OTHER SUPPORT SPACECRAFT ASSIGNED TO IT. A TYPE ORGANIZATION MAY BE COMMANDED BY AN OFFICER OF THE RANK COMMODORE OR ABOVE.
 9. SERVICE FORCE
THE SERVICE FORCE SHALL BE MADE UP OF CARGO, REPAIR, TRANSPORT, AND HOSPITAL SPACECRAFT DURING PEACETIME. IN THE EVENT OF HOSTILITIES THESE VESSELS WILL BE VARIOUSLY DISTRIBUTED AMONG THE FLEETS AND FORCES. A SERVICE FORCE MAY BE COMMANDED BY ANY QUALIFIED STARSHIP COMMANDER.

RS: 480371.3

TO: 01:02:00:73.03



ADMINISTRATIVE ORDER

STAR FLEET DIVISION-REORGANIZATION

D. A SPACECRAFT ASSIGNED TO THE STAR FLEET OPERATING FORCES SHALL BE DESIGNATED EITHER CLASS ONE STARSHIP OF THE LINE, CLASS TWO SUPPORT SPACECRAFT, OR CLASS THREE SMALL SPACECRAFT. A STARSHIP SHALL BE FURTHER CLASSIFIED BY NAME, NAVAL CONSTRUCTION CONTRACT NUMBER, AND TYPE. THE FOLLOWING TYPES SHALL BE CONSIDERED DEFINITIVE FOR STAR FLEET OPERATING FORCES SPACECRAFT AT THIS MOMENT, BUT MAY BE MODIFIED IN THE FUTURE:

1. CLASS ONE STARSHIP OF THE LINE

- a. MK I CORSAIR
- b. MK II CLIPPER
- c. MK III LIGHT CRUISER
- d. MK IV CRUISER
- e. MK V FRIGATE
- f. MK VI TRANSPORT/TUG
- g. MK VII SCOUT
- h. MK VIII DESTROYER
- i. MK IX HEAVY CRUISER
- j. MK X DREADNOUGHT
- k. MK XI HEAVY FRIGATE
- l. MK XII HEAVY DESTROYER
- m. MK XIII BATTLECRUISER
- n. MK XIV CORVETTE
- o. MK XV THROUGH-DECK CRUISER
- p. MK XVI SHUTTLECARRIER
- q. MK XVII SPACE CONTROL SHIP
- r. MK XVIII SUPERSCOOT
- s. MK XIX FAST FRIGATE
- t. MK XX STRIKE CRUISER
- u. MK XXI COMMAND SHIP

2. CLASS TWO SUPPORT SPACECRAFT

- a. MK A PATROL CUTTER
- b. MK B RESEARCH VESSEL
- c. MK C SCOOP
- d. MK D STARSHIP TENDER
- e. MK E STARSHIP ESCORT
- f. MK F TRANSPORT/FREIGHTER
- g. MK G CARGO VESSEL
- h. MK H BREAKER

3. CLASS THREE SMALL SPACECRAFT

- a. MK A OBSERVATION AND MINIMAL TRAVEL CRAFT
- b. MK B SINGLE OPERATOR MULTI-PURPOSE CRAFT
- c. MK C ATMOSPHERIC TRANSPORT
- d. MK D IMPULSE DRIVEN SHUTTLECRAFT
- e. MK E WARP DRIVEN SHUTTLECRAFT
- f. MK F LIFEBOAT
- g. MK G BARGE/SKIFF

E. THE COMMAND STRUCTURE OF OFFICERS ABOARD STAR FLEET OPERATING FORCES SPACECRAFT SHALL BE AS FOLLOWS:

1. LINE DIVISION

LINE DIVISION OFFICERS SHALL HAVE CHARGE OF THE DECK, SHIP'S SERVICES AND SCIENCES GROUPS ABOARD SHIP, AND SHALL STAND WATCH AS OFFICER OF THE DECK OR ENGINEER OF THE WATCH. THEY SHALL BE RESPONSIBLE FOR THE CARE AND UPKEEP OF THAT PART OF THE SPACECRAFT ASSIGNED TO THEIR GROUP AND FOR THE TRAINING OF THEIR CREWS.

a. DECK GROUP

(1) CAPTAIN

THE CAPTAIN SHALL BE IN COMMAND AND CHARGED WITH FULL RESPONSIBILITY FOR THE CARE AND EFFICIENCY OF THE SPACECRAFT AND THE WELFARE OF ALL HANDS. HE/SHE IS TO BE AN OFFICER OF THE LINE AND, IN CASE OF HIS/HER ABSENCE OR INCAPACITATION, HE/SHE WILL BE SUCCEEDED BY THE LINE OFFICER NEXT IN RANK.

RS: 480371-3

TO: 01:02:00:73.04



ADMINISTRATIVE ORDER

STAR FLEET DIVISION-REORGANIZATION

(2) EXECUTIVE OFFICER

THE EXECUTIVE OFFICER SHALL BE THE LINE OFFICER NEXT IN RANK TO THE CAPTAIN. HE/SHE SHALL HAVE ENTIRE CHARGE, UNDER DIRECTION OF THE CAPTAIN, OF ALL MATTERS RELATING TO THE PERSONNEL, ROUTINE, AND DISCIPLINE OF THE SPACECRAFT. ALL ORDERS ISSUED BY HIM/HER WILL BE CONSIDERED AS COMING DIRECTLY FROM THE CAPTAIN.

(3) FIRST LIEUTENANT (CHIEF MAINTENANCE AND DAMAGE CONTROL OFFICER)

THE FIRST LIEUTENANT SHALL BE THE LINE OFFICER THIRD IN RANK ABOARD SHIP. HE/SHE SHALL HAVE CHARGE OF DAMAGE CONTROL AND SHALL BE RESPONSIBLE FOR THE CLEANLINESS, AIR-TIGHT INTEGRITY, AND GENERAL CARE AND REPAIR OF THE STRUCTURAL ELEMENTS OF THE SHIP. HE/SHE SHALL FURTHERMORE BE RESPONSIBLE FOR THE PREPAREDNESS, TRAINING, AND GENERAL CONDUCT OF THE MAINTENANCE AND DAMAGE CONTROL CREW.

(4) CHIEF HELM OFFICER

THE CHIEF HELM OFFICER SHALL BE RESPONSIBLE FOR THE PREPAREDNESS, TRAINING, AND GENERAL CONDUCT OF THE HELM CREW. ON WATCH HE/SHE WILL ACT AS HELMSMAN, AND AS SUCH WILL BE CHARGED WITH CLOSE QUARTERS MANUEVERING, WARP ENGAGEMENTS AND GRADATION, AND/OR PROPULSION MODULATION.

(5) CHIEF NAVIGATION OFFICER

THE CHIEF NAVIGATION OFFICER SHALL HAVE CHARGE OF THE NAVIGATION DEPARTMENT, AND SHALL BE RESPONSIBLE FOR THE PREPAREDNESS, TRAINING, AND GENERAL CONDUCT OF THE NAVIGATION CREW. ON WATCH HE/SHE WILL ACT AS NAVIGATOR, AND THUS BE RESPONSIBLE FOR THE SAFE NAVIGATION OF THE SPACECRAFT.

(6) CHIEF ORDNANCE OFFICER

THE CHIEF ORDNANCE OFFICER SHALL HAVE CHARGE OF THE ORDNANCE DEPARTMENT, AND AS SUCH SHALL BE RESPONSIBLE FOR ALL ONBOARD WEAPONS AND DEFENSE SYSTEMS, AND FOR THE PREPAREDNESS, TRAINING, AND GENERAL CONDUCT OF THE ORDNANCE CREW.

(7) CHIEF FLIGHT OFFICER

ON STARSHIPS OUTFITTED WITH CLASS THREE SMALL SPACECRAFT, THE CHIEF FLIGHT OFFICER WILL COMMAND ALL FLIGHT DECK OPERATIONS, AND SHALL BE RESPONSIBLE FOR THE PREPAREDNESS, TRAINING, AND GENERAL CONDUCT OF THE FLIGHT CREW. ON STARSHIPS OUTFITTED WITH ATTACK SPACECRAFT, HE/SHE WILL ALSO COMMAND THE FIGHTER PILOT CREW.

b. SHIP'S SERVICES GROUP

(1) CHIEF ENGINEERING OFFICER

THE CHIEF ENGINEERING OFFICER SHALL HAVE CHARGE OF THE ENGINEERING DEPARTMENT, AND SHALL BE RESPONSIBLE FOR ALL THE SHIP'S DRIVE, LIFE SUPPORT, TRANSPORTER SYSTEMS, AND AUXILIARY MACHINERY. HE/SHE WILL ALSO BE RESPONSIBLE FOR THE PREPAREDNESS, TRAINING, AND GENERAL CONDUCT OF THE ENGINEERING CREW.

(2) CHIEF SECURITY OFFICER

THE CHIEF SECURITY OFFICER SHALL HAVE CHARGE OF THE SECURITY DEPARTMENT, AND SHALL BE RESPONSIBLE (UNDER THE DIRECTION OF THE EXECUTIVE OFFICER), FOR SHIP'S DISCIPLINE. HE SHALL FURTHERMORE BE RESPONSIBLE FOR THE PREPAREDNESS, TRAINING AND GENERAL CONDUCT OF THE SECURITY CREW.

(3) CHIEF COMMUNICATIONS OFFICER

THE CHIEF COMMUNICATIONS OFFICER SHALL BE RESPONSIBLE FOR THE SHIP'S SHORT-RANGE AND SUBSPACE COMMUNICATIONS EQUIPMENT, AND FOR THE HANDLING OF INCOMING AND OUTGOING TRANSMISSIONS AND COMMUNICATIONS. HE/SHE WILL ALSO BE RESPONSIBLE FOR THE PREPAREDNESS, TRAINING AND GENERAL CONDUCT OF THE COMMUNICATIONS CREW.

c. SCIENCES GROUP

(1) CHIEF SCIENCES OFFICER

THE CHIEF SCIENCES OFFICER SHALL HAVE CHARGE OF THE SCIENCES DEPARTMENT, AND AS SUCH WILL BE RESPONSIBLE FOR THE SHIP'S LIBRARY COMPUTER DATA UPKEEP, SCIENTIFIC EQUIPMENT, SCIENTIFIC MISSIONS, AND SCIENCES CREW. HE/SHE WILL FURTHERMORE BE RESPONSIBLE FOR THE PREPAREDNESS, TRAINING, AND GENERAL CONDUCT OF THE SCIENCES CREW.

2. STAFF DIVISION

SPECIALISTS IN CERTAIN FIELDS SHALL BE APPOINTED, UPON COMMISSIONING, TO THE APPROPRIATE STAFF DIVISION. FOR THE PRESENT TIME THERE WILL BE FIVE STAFF DIVISIONS: MEDICAL, NURSING, SUPPLY, CIVIL ENGINEERING, AND RECORDS. COMMISSIONED OFFICERS OF THESE DIVISIONS SHALL HAVE ALL THE PRIVILEGES AND RIGHTS OF THEIR RANKS; THEY SHALL NOT, HOWEVER, BE ELIGIBLE TO TAKE COMMAND EXCEPT IN THEIR OWN DIVISIONS.



ADMINISTRATIVE ORDER

STAR FLEET DIVISION-REORGANIZATION

RS: 480371-3

TO: 01:02:00:73.06

a. DECK GROUP

(1) CHIEF RECORDS OFFICER

THE CHIEF RECORDS OFFICER SHALL HAVE RESPONSIBILITY FOR THE CARE AND MAINTENANCE OF SHIP'S RECORDS (EXCEPT LIBRARY COMPUTER DATA UPKEEP) AND CLASSIFIED FILES. HE/SHE SHALL FURTHERMORE BE RESPONSIBLE FOR THE ASSIGNMENT AND BERTHING OF PERSONNEL, AND FOR THE PREPAREDNESS, TRAINING, AND GENERAL CONDUCT OF YEOMEN AND OTHER RECORDS STAFF.

b. SHIP'S SERVICES GROUP

(1) CHIEF SUPPLY OFFICER

THE CHIEF SUPPLY OFFICER SHALL HAVE CHARGE OF THE SUPPLY DEPARTMENT, AND AS SUCH SHALL BE RESPONSIBLE FOR THE SHIP'S GENERAL MESS, FABRICATORS AND RAW MATERIALS FOR USE IN FABRICATION, PAY ACCOUNTS, PURCHASES, AND PAYMENT OF PROPER BILLS AGAINST THE SHIP. HE/SHE SHALL FURTHERMORE BE RESPONSIBLE FOR THE PREPAREDNESS, TRAINING, AND GENERAL CONDUCT OF THE SUPPLY STAFF.

c. SCIENCES GROUP

(1) CHIEF MEDICAL OFFICER

THE CHIEF MEDICAL OFFICER SHALL HAVE CHARGE OF THE MEDICAL DEPARTMENT, AND AS SUCH SHALL BE RESPONSIBLE FOR THE SICK BAY, FOR THE MENTAL AND PHYSICAL HEALTH OF ALL HANDS ABOARD SHIP, AND FOR THE PREPAREDNESS, TRAINING, AND GENERAL CONDUCT OF THE MEDICAL STAFF.

(2) CHIEF NURSING OFFICER

THE CHIEF NURSING OFFICER SHALL HAVE IMMEDIATE RESPONSIBILITY FOR THE PREPAREDNESS, TRAINING, AND GENERAL CONDUCT OF THE NURSING STAFF, AND SHALL HAVE IMMEDIATE COMMAND OF THE NURSING STAFF UNDER THE GENERAL COMMAND OF THE CHIEF MEDICAL OFFICER.

V. STAR FLEET SHORE ESTABLISHMENT

A. THE STAR FLEET SHORE ESTABLISHMENT SHALL COMPRISE THE FIELD ACTIVITIES OF THE BUREAUS AND OFFICES OF THE STAR FLEET DIVISION, AND SHALL INCLUDE ALL GROUND AND SPACE-BASED ACTIVITIES NOT ASSIGNED TO THE OPERATING FORCES. COLLECTIVELY THE FUNCTION OF THE SHORE ESTABLISHMENT ACTIVITIES SHALL BE TO SUPPLY, MAINTAIN, AND SUPPORT THE OPERATING FORCES, UNDER THE DIRECTION OF STAR FLEET COMMAND.

B. THE CHIEF OF SHORE ESTABLISHMENTS SHALL HAVE COMMAND OF THE STAR FLEET SHORE ESTABLISHMENT, AND AS SUCH SHALL HAVE RESPONSIBILITY FOR THE OPERATION OF ALL STATIONARY INSTALLATIONS, PUBLIC WORKS, AND PUBLIC UTILITIES OF STAR FLEET, INCLUDING BUT NOT RESTRICTED TO STAR BASES, STAR STATIONS, PLANETARY AND SPACE OUTPOSTS, CONSTRUCTION AND REPAIR FACILITIES, AND THE VARIOUS HEADQUARTERS OF THE FLEETS AND STAR FLEET COMMAND. HE/SHE SHALL FURTHERMORE BE COMMANDER-IN-CHIEF OF THE STAR FLEET CORPS OF ENGINEERS.

C. FEDERATION TREATY SPACE SHALL BE DIVIDED INTO FOUR QUADRANTS AND A CENTRAL SPHERE CALLED QUADRANT ZERO. THE FOUR OUTSIDE QUADRANTS SHALL BE DIVIDED INTO NORTHERN AND SOUTHERN HALVES. EACH OF THESE NINE MAJOR DIVISIONS OF FEDERATION SPACE SHALL BE ASSIGNED A FLEET FOR EXPLORATORY AND DEFENSE DUTIES. THESE FLEETS WILL IN TURN BE SUPPORTED BY AN INITIAL TOTAL OF 28 STAR BASES, 15 OF WHICH WILL BE IN THE OUTLYING REACHES OF QUADRANT ZERO, WHILE 13 WILL BE DISPERSED THROUGH THE EIGHT LARGELY-UNEXPLORED SUBQUADRANTS. ONE STAR BASE IN EACH SUBQUADRANT WILL BE DESIGNATED COMMAND BASE FOR THE FLEET ASSIGNED TO THAT AREA OF SPACE. IT SHALL BE A MAJOR RESPONSIBILITY OF THE CHIEF OF SHORE ESTABLISHMENTS TO ASSURE THE SMOOTH OPERATION OF THESE COMMAND BASES, AND ALL OTHER STAR BASES, SO THAT THE FLEETS MAY BETTER PERFORM THEIR ESSENTIAL TASKS.

COMMAND BASES FOR THE SUBQUADRANT FLEETS SHALL BE:

SUBQUADRANT FLEET	STAR BASE
0	1
1N	7
1S	28
2N	27
2S	12
3N	11
3S	19
4N	25
4S	17



ADMINISTRATIVE ORDER

STAR FLEET DIVISION-REORGANIZATION

D. ANY MEMBER PLANET OF THE FEDERATION THAT SO DESIRES SHALL, UPON REQUEST, HAVE A DEFENSE FORCE ASSIGNED TO ITS STAR SYSTEM. COMMAND BASES FOR THE SEVERAL SYSTEM DEFENSE FORCES CURRENTLY DEPLOYED SHALL BE:

1. ALDEBARAN (ALPHA TAURI III)
2. ALPHA
3. ALPHA PROXIMA II
4. AL RIJIL (ALPHA CENTAURI VII)
5. ANDOR (EPSILON INDI VIII)
6. ARDANA (MU LEONIS A III)
7. CAIT
8. CYGNET XIV
9. DARAN V
10. DELTA IV
11. DENEV V (ALPHA CYGNI V)
12. EARTH (SOL III)-STAR FLEET HEADQUARTERS
13. EDOS
14. ETA SERPENTIS VI
15. IZAR (EPSILON BOOTIS III)
16. MAKUS
17. MARS (SOL IV)
18. RIGEL IV (BETA ORIONIS IV)
19. TELLAR (61 CYGNI A V)
20. TIBURON (OMEGA FORNACIS III)
21. VEGA (ALPHA LYRAE IX)

RS: 480371.3

TO: 01:02:00:73.07



OFFICIAL TYPE STYLE

TERRANGO CHARACTERS - STAR FLEET SPECIFICATION*

A	B	C	D	E	F
G	H	I	J	K	L
M	N	O	P	Q	R
S	T	U	V	W	X
Y	Z	1	2	3	4
5	6	7	8	9	0

* FOR STARSHIP/SPACECRAFT NOMINAL AND NUMERICAL DESIGNATIONS.



OFFICIAL TYPE STYLE

TERRANGLO CHARACTERS-STAR FLEET SPECIFICATION*

A	B	C	D	E	F
G	H	I	J	K	L
M	N	O	P	Q	R
S	T	U	V	W	X
Y	Z	1	2	3	4
5	6	7	8	9	0

*FOR STARSHIP/SPACECRAFT NOMINAL AND NUMERICAL DESIGNATIONS.
USE IN CONJUNCTION WITH TYPESTYLE 01:02:04:01.01 FOR 200
STANDARD STARDATES. USE EXCLUSIVELY THEREAFTER.



OFFICIAL TYPE STYLE

TERRANGLO CHARACTERS - STAR FLEET SPECIFICATION*

A	B	C	D	E	F
G	H	I	J	K	L
M	N	O	P	Q	R
S	T	U	V	W	X
Y	Z	1	2	3	4
5	6	7	8	9	0

*FOR STARSHIP/SPACECRAFT NOMINAL AND NUMERICAL DESIGNATIONS.
SUPERSEDES TO:01:02:04:01.02.

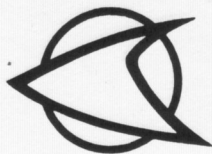

INSIGNIA & SLEEVE MARKS

STAR FLEET OFFICERS

SLEEVE MARKS

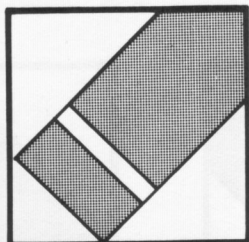

SR. OFFICERS

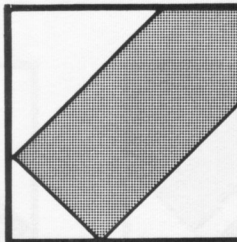

JR. OFFICERS

DRESS UNIFORM EPAULETS

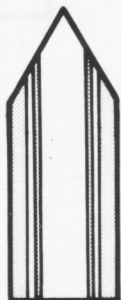

SR. OFFICERS

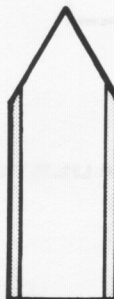

JR. OFFICERS

UNIFORM INSIGNIA-GROUP & DEPARTMENTAL

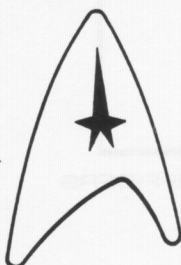

DECK GROUP*

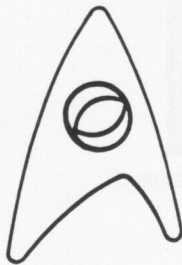

SCIENCES GROUP*

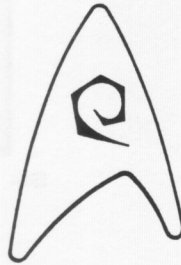

SHIP'S SERVICES GROUP*



MEDICAL DEPARTMENT

UNIFORM INSIGNIA-FLEET REGISTRY



UNITED EARTH:
UNITED AMERICAS
REGISTRY
(USED UNTIL E. Y. 2254) *



UNITED EARTH:
OTHER THAN UNITED
AMERICAS REGISTRY
(USED UNTIL E. Y. 2254)

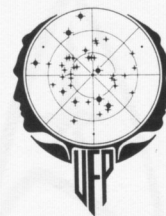

UNITED FEDERATION
OF PLANETS
(USED AFTER E. Y. 2254)



TUNIC COLOR: FSC 475 SAND, FSC 459 GREEN TAN, OR FSC 542 MEDIUM BLUE.



FSC 874 RED GOLD



FSC 001 WHITE

*GROUP INSIGNIA ARE BORDERLESS, WITH BACKGROUNDS OF OFF-WHITE INTERWOVEN WITH GOLD.

RS: 480371.4

TO: 01:03:01:10.01

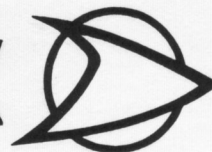

INSIGNIA & SLEEVE MARKS

STAR FLEET OFFICERS

SLEEVE MARKS

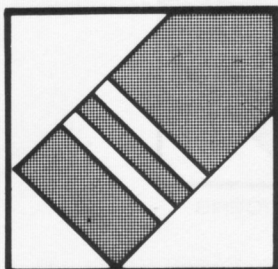

COMMAND

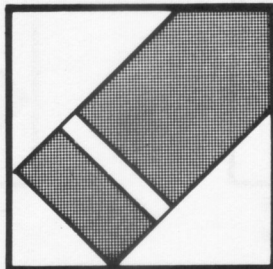

SR. OFFICERS

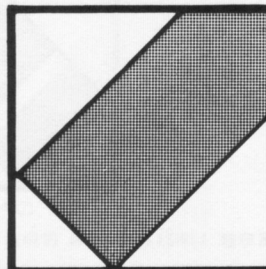

JR. OFFICERS

DRESS UNIFORM EPAULETS

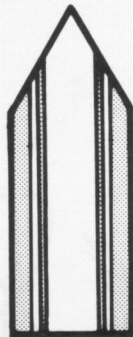

COMMAND

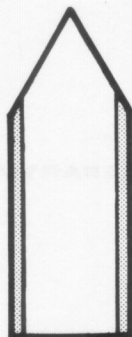

SR. OFFICERS



JR. OFFICERS

GROUP INSIGNIA

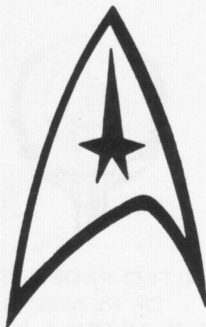

DECK GROUP

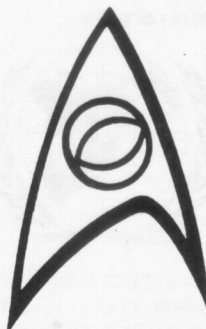

SHIP'S SERVICES GROUP*

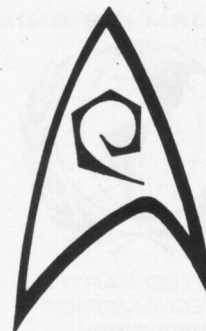

SCIENCES GROUP*

 FSC 001 WHITE

 FSC 873 GOLD

 TUNIC COLOR: FSC 475 SAND, FSC 459 GREEN TAN, OR FSC 542 MEDIUM BLUE.

* BY THE UNIFORM REGULATION OF SD 6507.19, THE SHIP'S SERVICES AND SCIENCES GROUPS EXCHANGED INSIGNIA. THIS ORDER WAS REVERSED ON SD 6605.20, THOUGH THE PATTERNS REPRODUCED ABOVE WERE RETAINED.

RS: 480371.4

TO:01:03:02:10.01

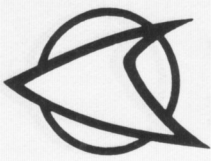

INSIGNIA & SLEEVE MARKS

REGULAR & NON-COMMISSIONED OFFICERS

UNIFORM INSIGNIA

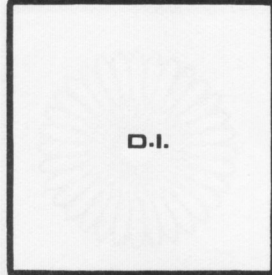
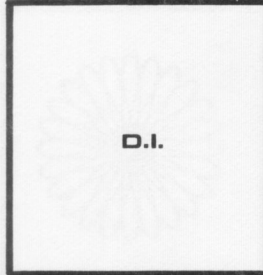
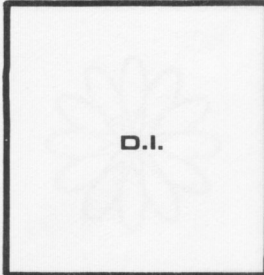

SLEEVE MARKING

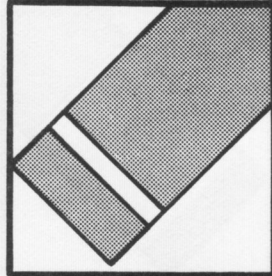
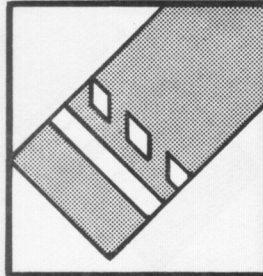
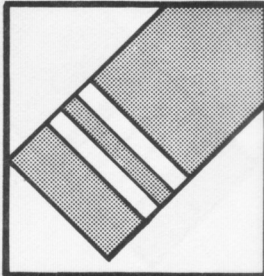
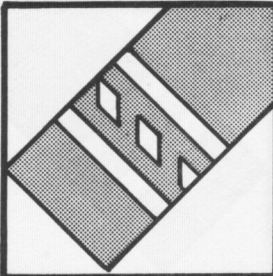

CAPTAIN

COMMANDER

LT. COMMANDER

LIEUTENANT

UNIFORM INSIGNIA

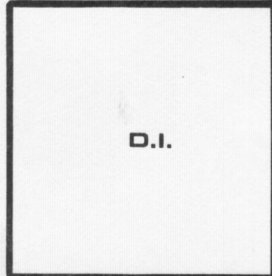
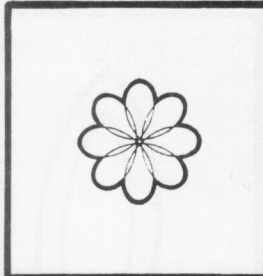
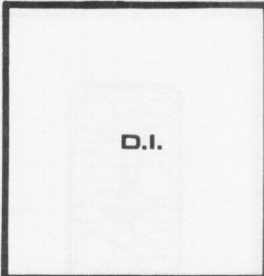

SLEEVE MARKING

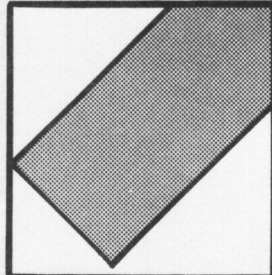
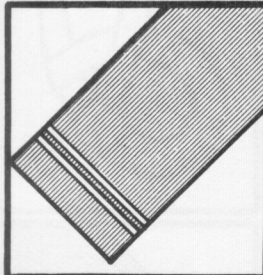
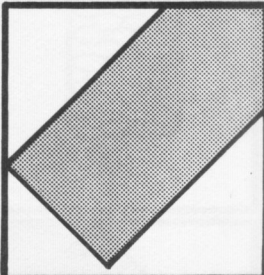
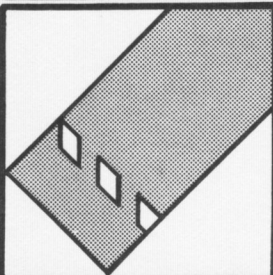

ENSIGN

ENSIGN APPOINTEE†

MIDSHIPMAN*

CREWMAN & PETTY OFFICER

D.I.-DIVISION INSIGNIA (SEE TO:01:03:03:10.03)
INSIGNIA SHOWN 1/2 ACTUAL SIZE.

† THIS RANK ELIMINATED SD 6701.04

***MIDSHIPMAN RANKS:**

- ONE STRIPE DENOTES FIRST YEAR
- TWO STRIPES DENOTE SECOND YEAR
- THREE STRIPES DENOTE THIRD YEAR
- NO STRIPE DENOTES FOURTH YEAR

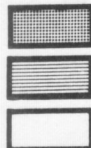

DIVISION COLOR* (SEE TO:01:03:03:10.04)



FSC 549 BLUE-GRAY



FSC 873 GOLD

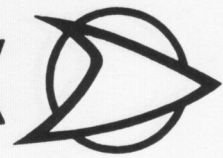

INSIGNIA & SLEEVE MARKS

FLAG OFFICERS

UNIFORM INSIGNIA

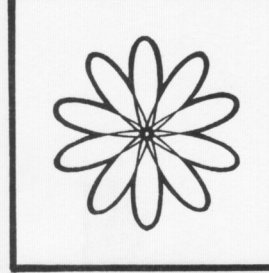
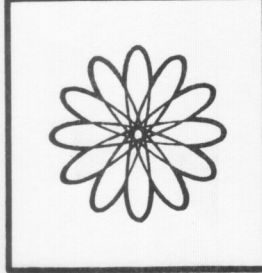
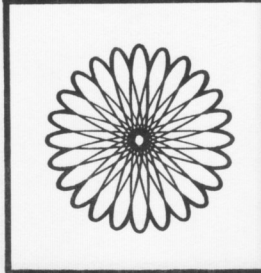
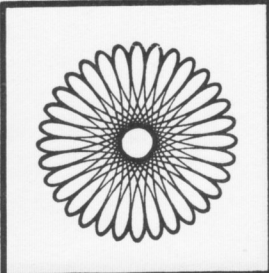

SLEEVE MARKING

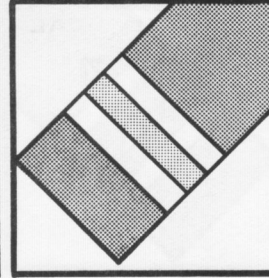
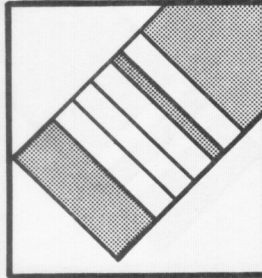
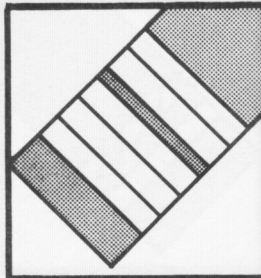
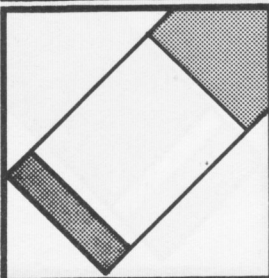

FLEET ADMIRAL

ADMIRAL

REAR ADMIRAL

FLT. COMMODORE*

UNIFORM INSIGNIA

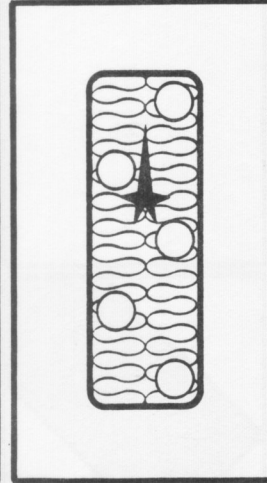
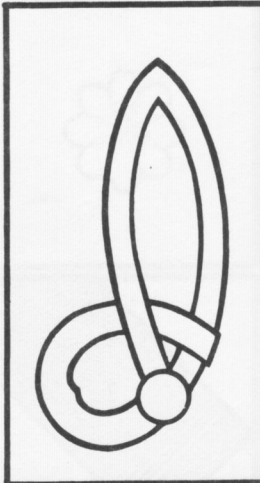

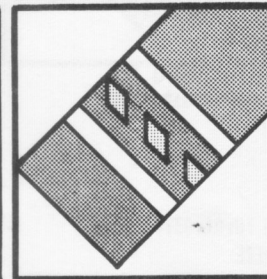
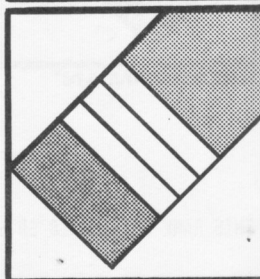

SLEEVE MARKING



COMMODORE

FLEET CAPTAIN†

INSIGNIA SHOWN 1/2 ACTUAL SIZE

-  DIVISION COLOR (SEE TO:01:03:03:10.04)
-  FSC 877 SILVER
-  FSC 873 GOLD

* THESE RANKS ELIMINATED 9D 6701.04
 † COMMAND DIVISION INSIGNIA SHOWN

RS: 480371-1

TO:01:03:03:10.02

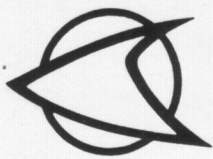

INSIGNIA & EPAULETS

STAR FLEET OPERATING FORCES

EPAULETS

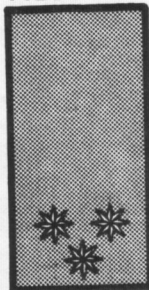

FLEET ADMIRAL



ADMIRAL



REAR ADMIRAL

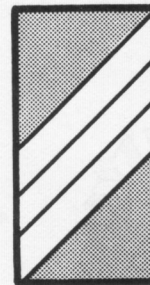

COMMODORE

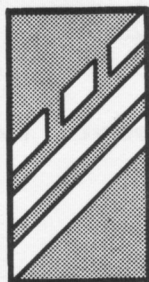

CAPTAIN

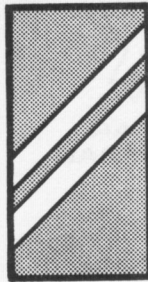

COMMANDER

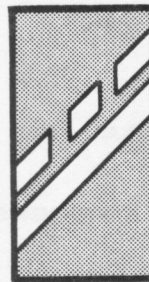

LT. COMMANDER



LIEUTENANT

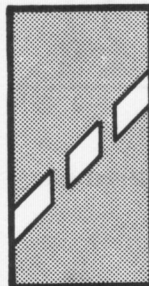

ENSIGN

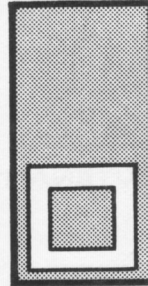

CHIEF PETTY OFCR.

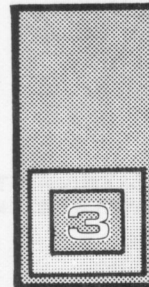

PETTY OFCR.*

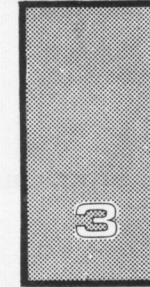

CREWMAN*

INSIGNIA

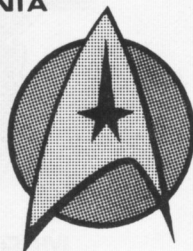

STANDARD

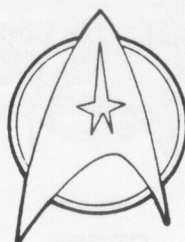

DRESS

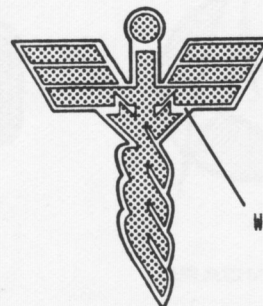

MEDICAL

WHITE BACKGROUND



FSC 877 SILVER



DIVISION COLOR (SEE TO:01:03:03:10.04)



FSC 873 GOLD



FSC 840 GREEN

*THIRD CLASS SHOWN

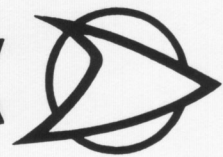

INSIGNIA & RANK DEVICES

STAR FLEET OPERATING FORCES-REGULAR & FLAG OFFICERS

RANK DEVICES-FLAG OFFICERS

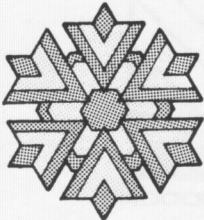

FLEET ADMIRAL

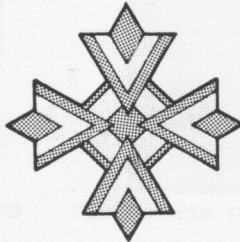

ADMIRAL

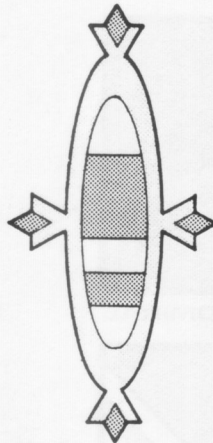

REAR ADMIRAL

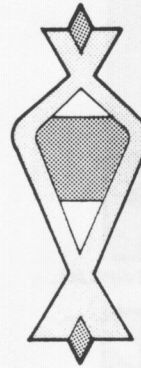

COMMODORE

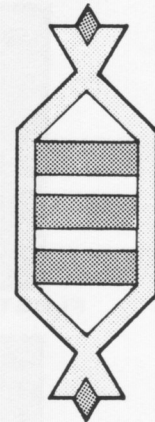

CAPTAIN

RANK DEVICES-REGULAR OFFICERS

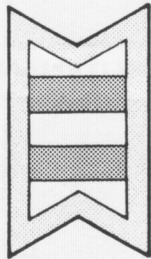

COMMANDER

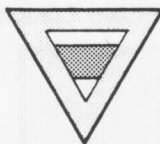

LIEUTENANT COMMANDER

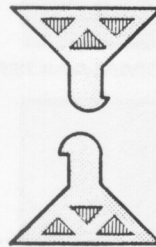

LIEUTENANT



ENSIGN

INSIGNIA

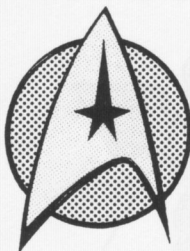

STANDARD

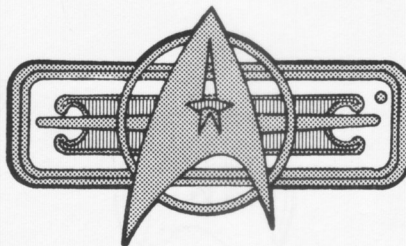

DRESS



MEDICAL*



FSC 873 GOLD



FSC 340 GREEN



FSC 001 WHITE



FSC 877 SILVER



FSC 321 TURQUOISE



DIVISION COLOR (SEE TO:01:03:03:01.04)

*WEARER MAY INSTEAD WEAR MEDICAL DEVICE OF HIS/HER DEGREE-EARNING INSTITUTION

RS: 480371.2

TO:01:03:07:20.01

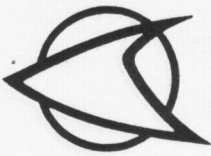

CLASS A DRESS UNIFORM

STAR FLEET - FEMALE ALL RANKS

UFP INSIGNIA*
FSC 874 RED GOLD

HATBAND
FSC 499
DARK MAROON

FSC 001 WHITE

GROUP
INSIGNIA*

EPAULETTE*

SLEEVE
MARKS*

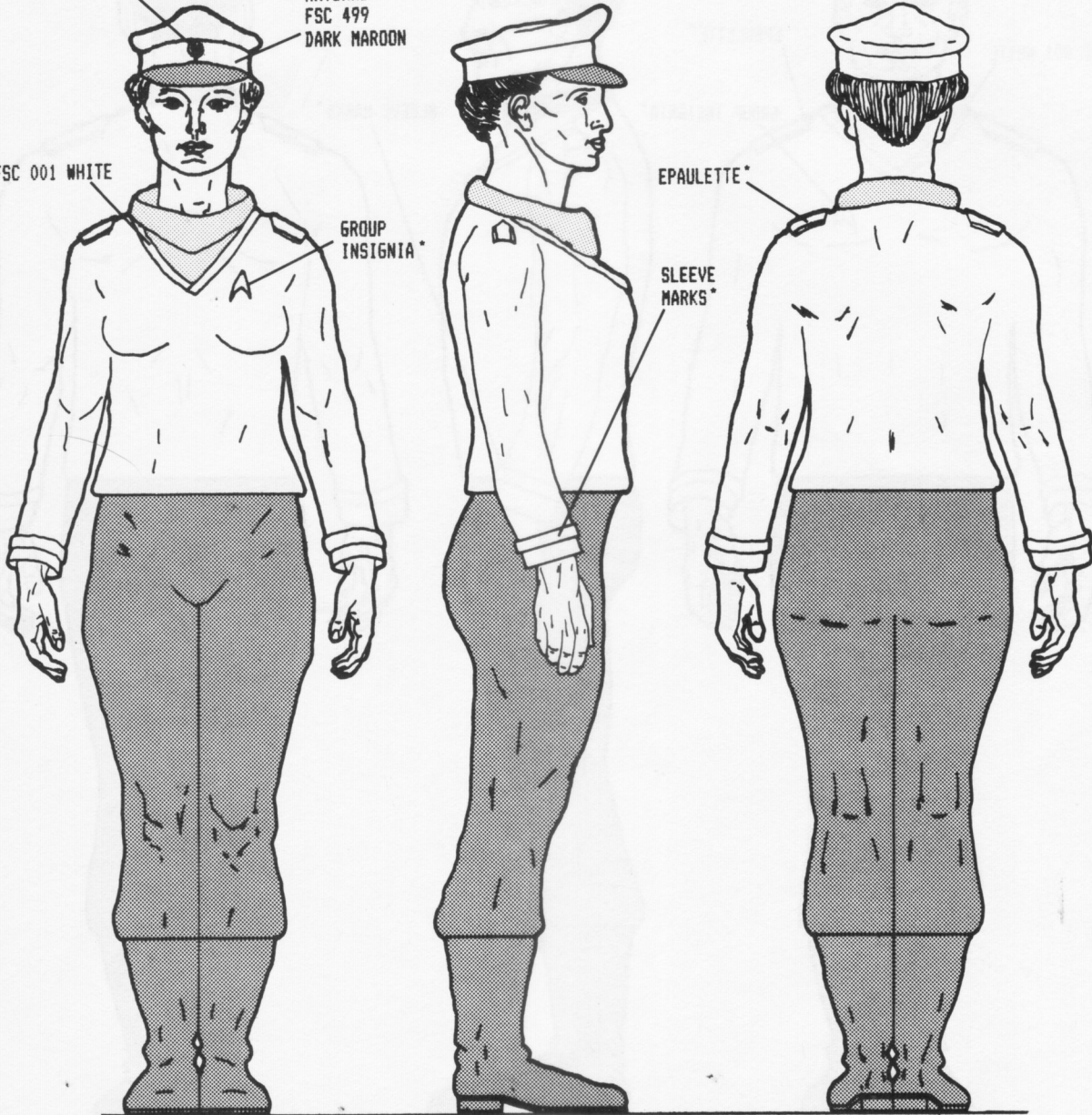

FSC 1000 BLACK

*SEE TO:01:03:01:10.01 AND TO:01:03:02:10.01



FSC 450 DARK GREEN GRAY



TUNIC COLOR: FSC 475 SAND, FSC 459
GREEN TAN, OR FSC 542 MEDIUM BLUE.

RS: 480371.4

TO:01:03:02:01.01

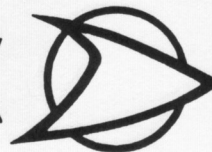



CLASS A DRESS UNIFORM

STAR FLEET--MALE ALL RANKS

RS: 480371.4

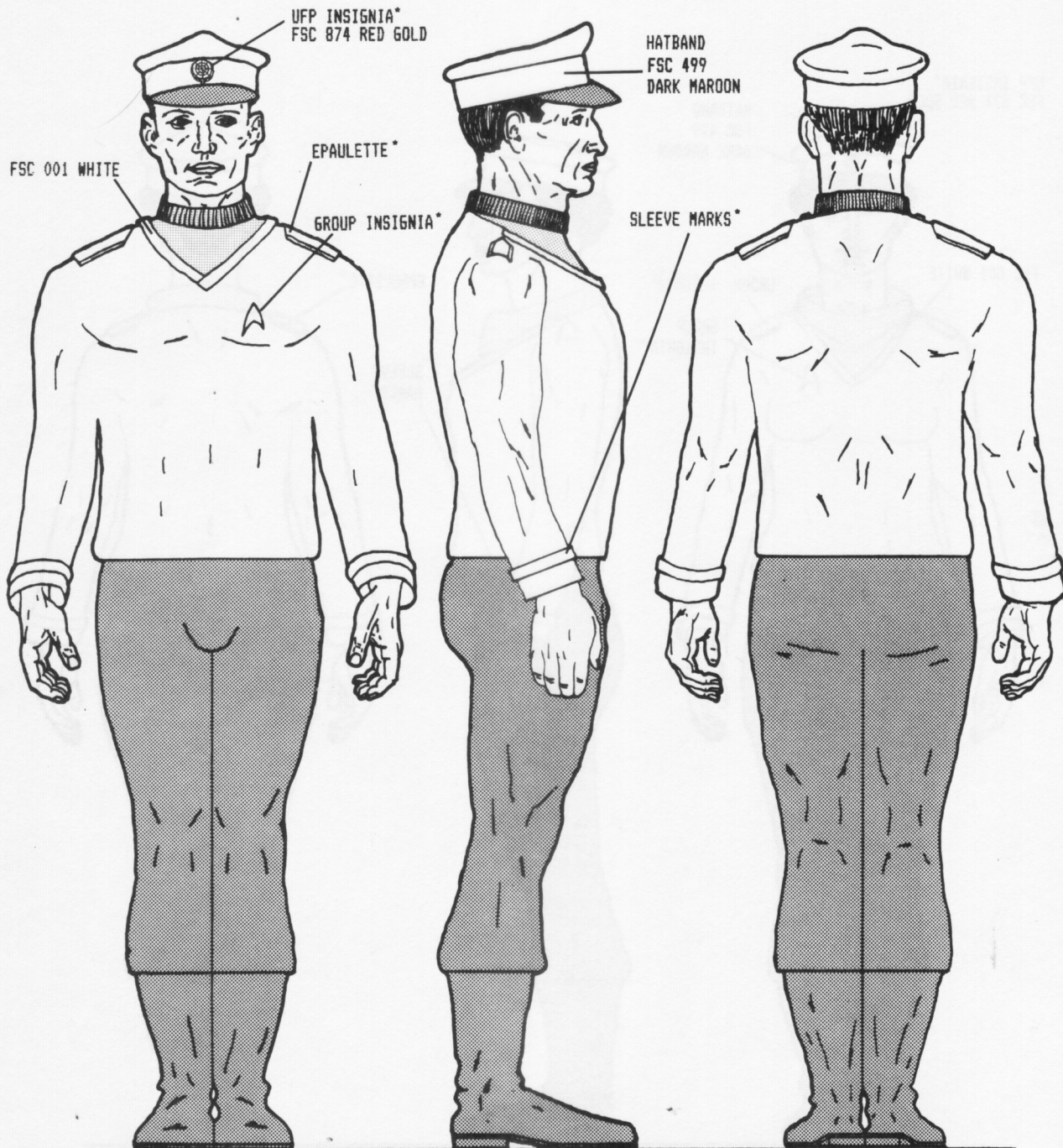
TO:01:03:02:01.02



-  FSC 1000 BLACK
-  FSC 450 DARK GREEN GRAY
-  TUNIC COLOR: FSC 475 SAND, FSC 459 GREEN TAN, OR FSC 542 MEDIUM BLUE.

*SEE TO:01:03:01:10.01 AND, TO:01:03:02:10.01

AMENDMENT CODE:OR

AUTHENTICATED STARDATE 6411.20

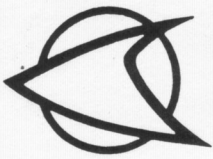

CLASS B UNDRRESS UNIFORM

STAR FLEET- FEMALE ALL RANKS

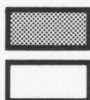
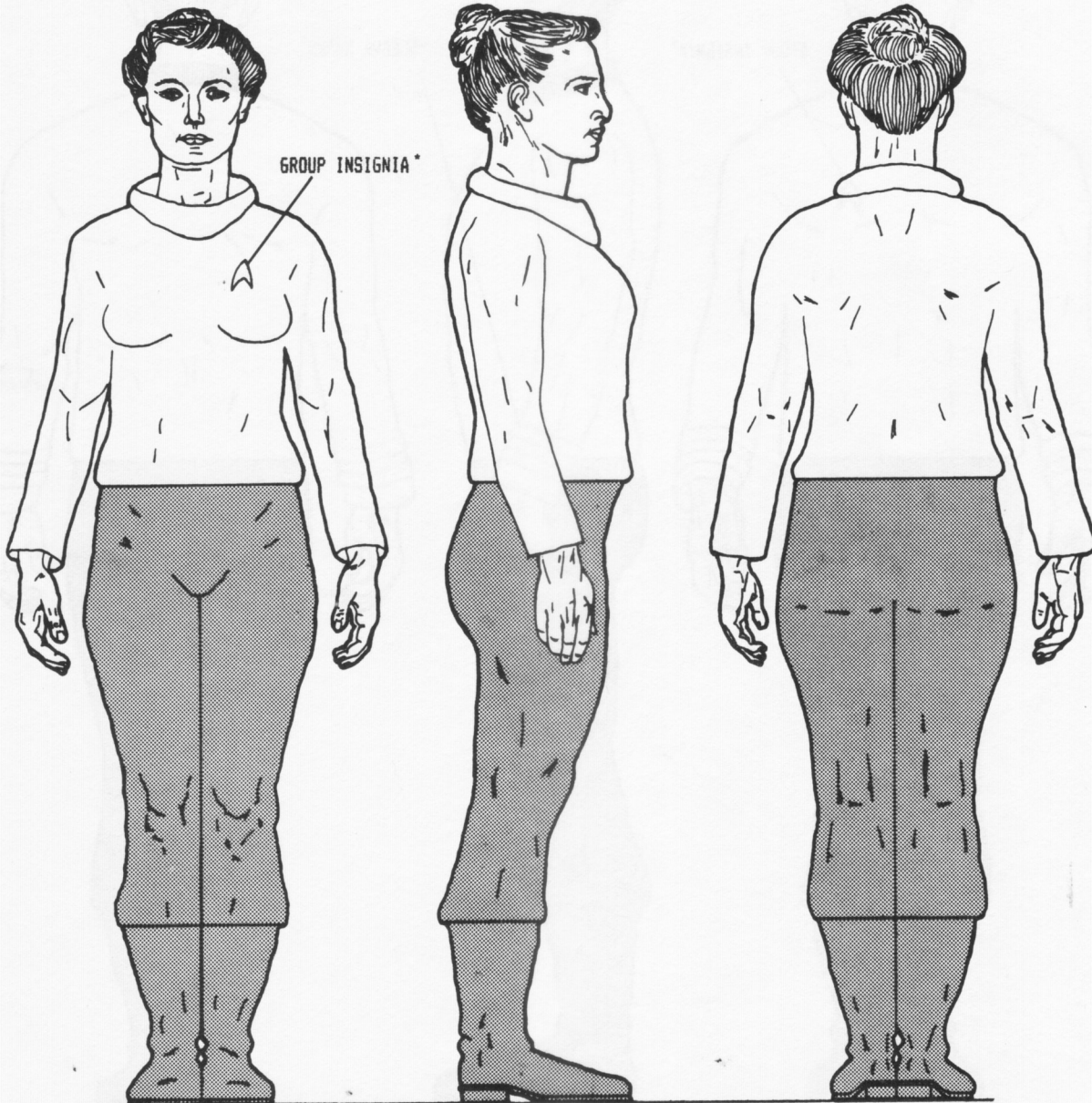

FSC 1000 BLACK

TUNIC COLOR: FSC 475 SAND, FSC 459 GREEN TAN, OR FSC 542 MEDIUM BLUE.

*SEE TO:01:03:01:10.01 AND TO:01:03:02:10.01

TUNIC COLOR DESIGNATES WEARER'S GROUP:
GREEN TAN / DECK GROUP; SAND / SHIP'S SERVICES GROUP; MEDIUM BLUE / SCIENCES GROUP.

RS: 480371.4

TO:01:03:02:02.01

AUTHENTICATED STARDATE 6411.20

AMENDMENT CODE:OR

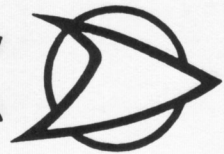

CLASS B UNDRRESS UNIFORM

STAR FLEET-MALE ALL RANKS

RS: 480371.4

TO:01:03:02:02.02

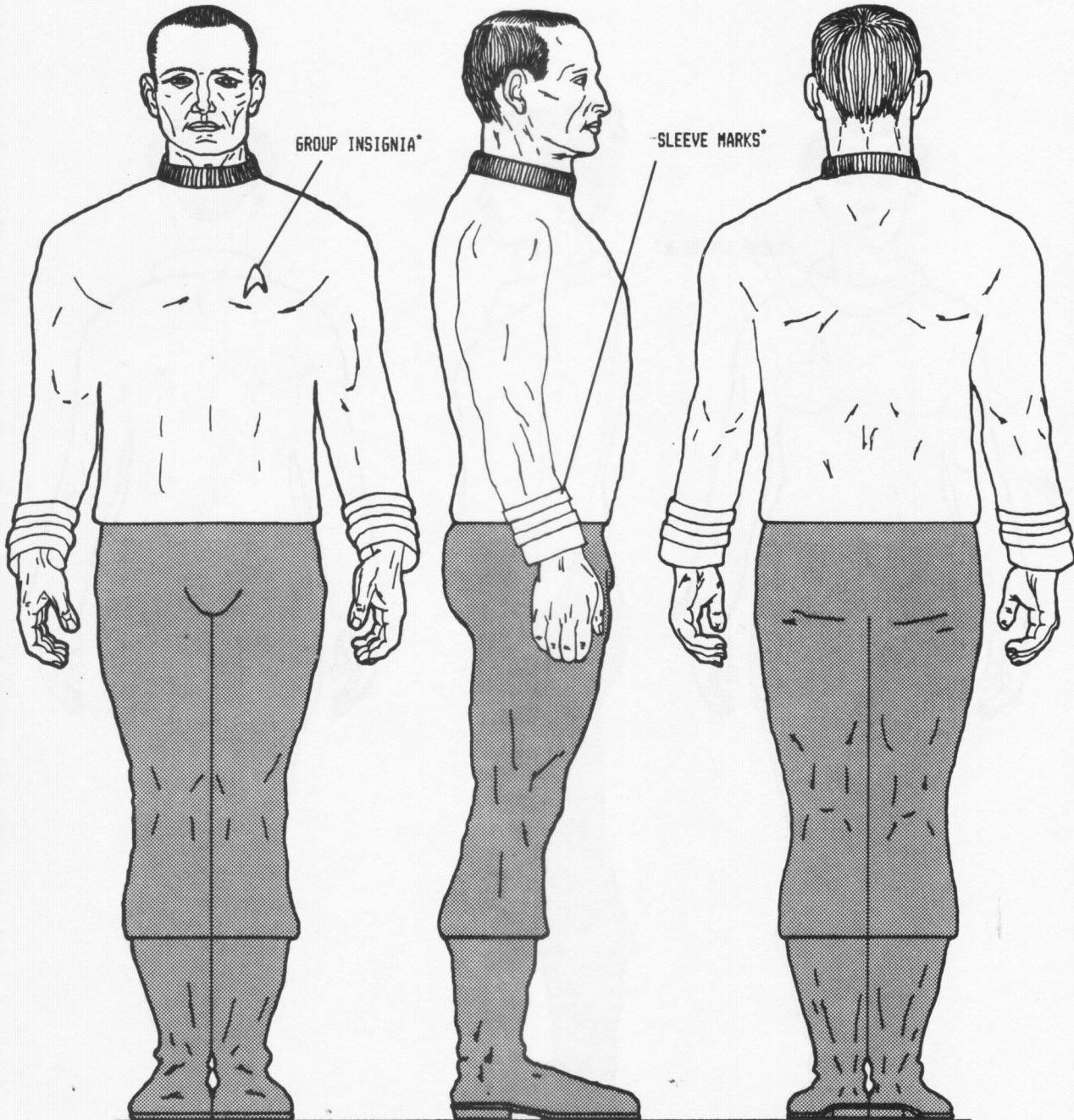

FSC 1000 BLACK



TUNIC COLOR: FSC 475 SAND, FSC 459 GREEN TAN, OR FSC 542 MEDIUM BLUE.

*SEE TO:01:03:01:10.01 AND TO:01:03:02:10.01

TUNIC COLOR DESIGNATES WEARER'S GROUP:
GREEN TAN / DECK GROUP; SAND / SHIP'S SERVICES GROUP; MEDIUM BLUE / SCIENCES GROUP.

AMENDMENT CODE:OR

AUTHENTICATED STARDATE 6411.20

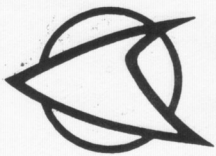

CLASS D WORKSUIT

STAR FLEET- UNISEX ALL RANKS

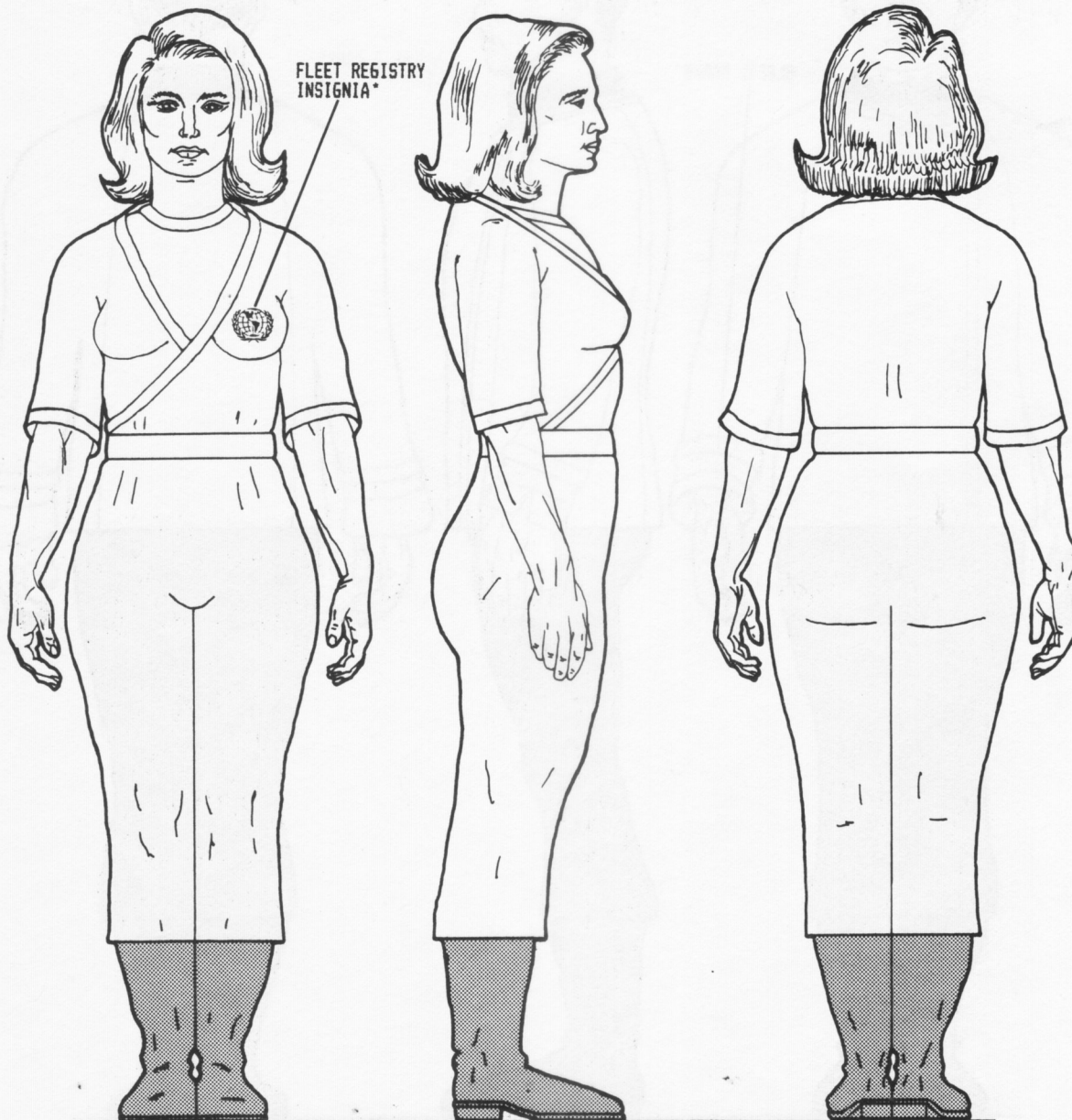

 WORKSUIT COLOR: FSC 552 LIGHT GRAY
BLUE OR FSC 475 LIGHT TAN.

 FSC 1000 BLACK

*SEE TO:01:03:01:10.01 AND TO:01:03:02:10.01

WORKSUIT COLOR INDICATES WEARER'S RANK: FSC
552 LIGHT GRAY BLUE FOR SENIOR OFFICERS AND
FSC 475 LIGHT TAN FOR JUNIOR OFFICERS.

RS: 480371.4

TO:01:03:02:04.01

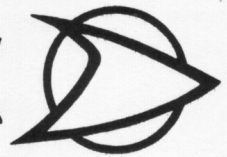

CLASS E SPECIAL DUTY GARMENT

STAR FLEET-EXCURSION COAT

RS: 480371.4

TO:01:03:02:05.01

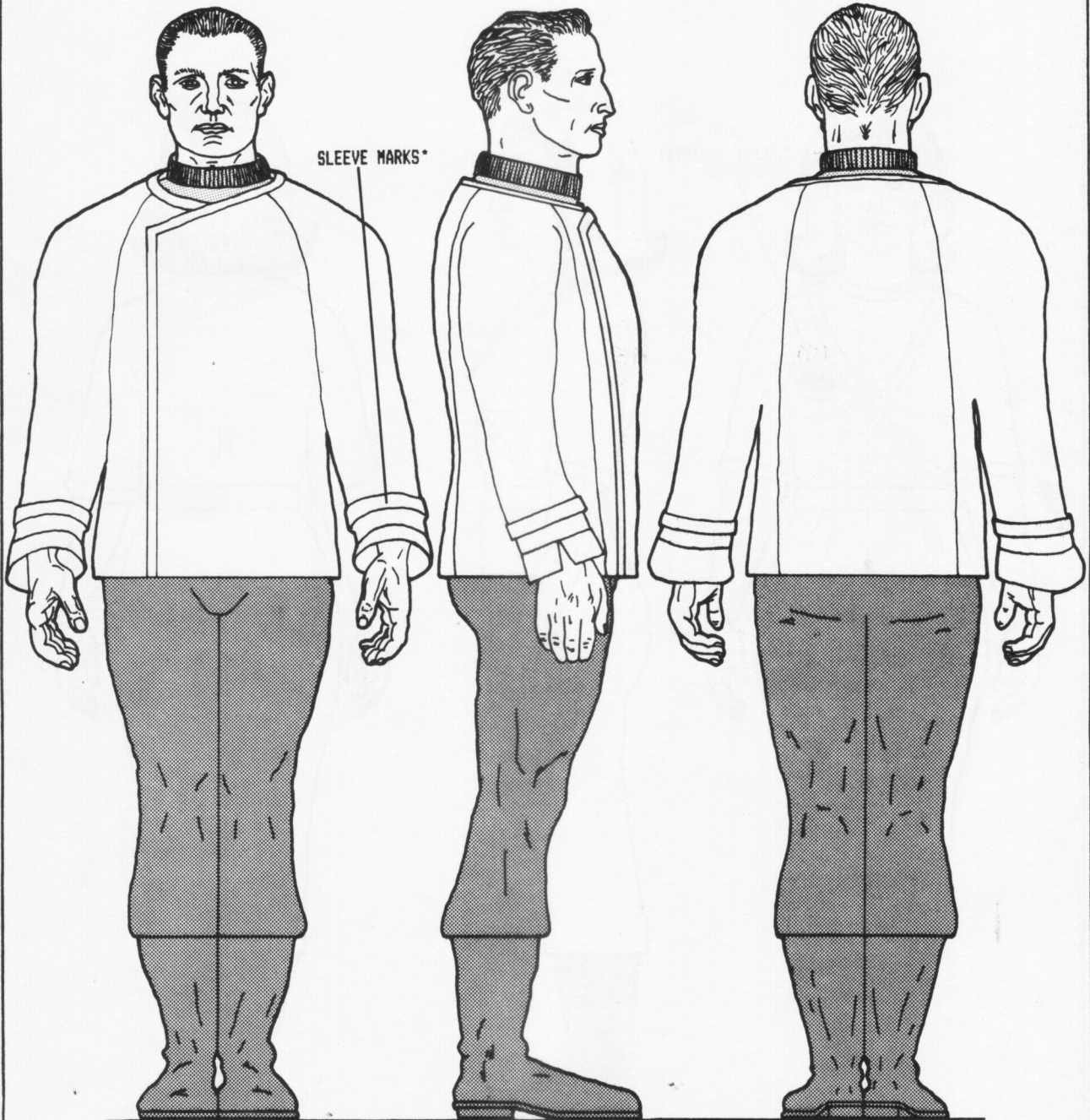

FSC 410 BROWN GRAY

*SEE TO:01:03:01:10.01 AND TO:01:03:02:10.01



FSC 1000 BLACK



TUNIC COLOR: FSC 475 SAND, FSC 459 GREEN TAN, OR FSC 542 MEDIUM BLUE.

AMENDMENT CODE:OR

AUTHENTICATED STARDATE 6411.20

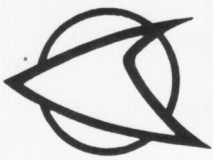

CLASS E SPECIAL DUTY GARMENT

STAR FLEET-SICKBAY RECOVERY OUTFIT

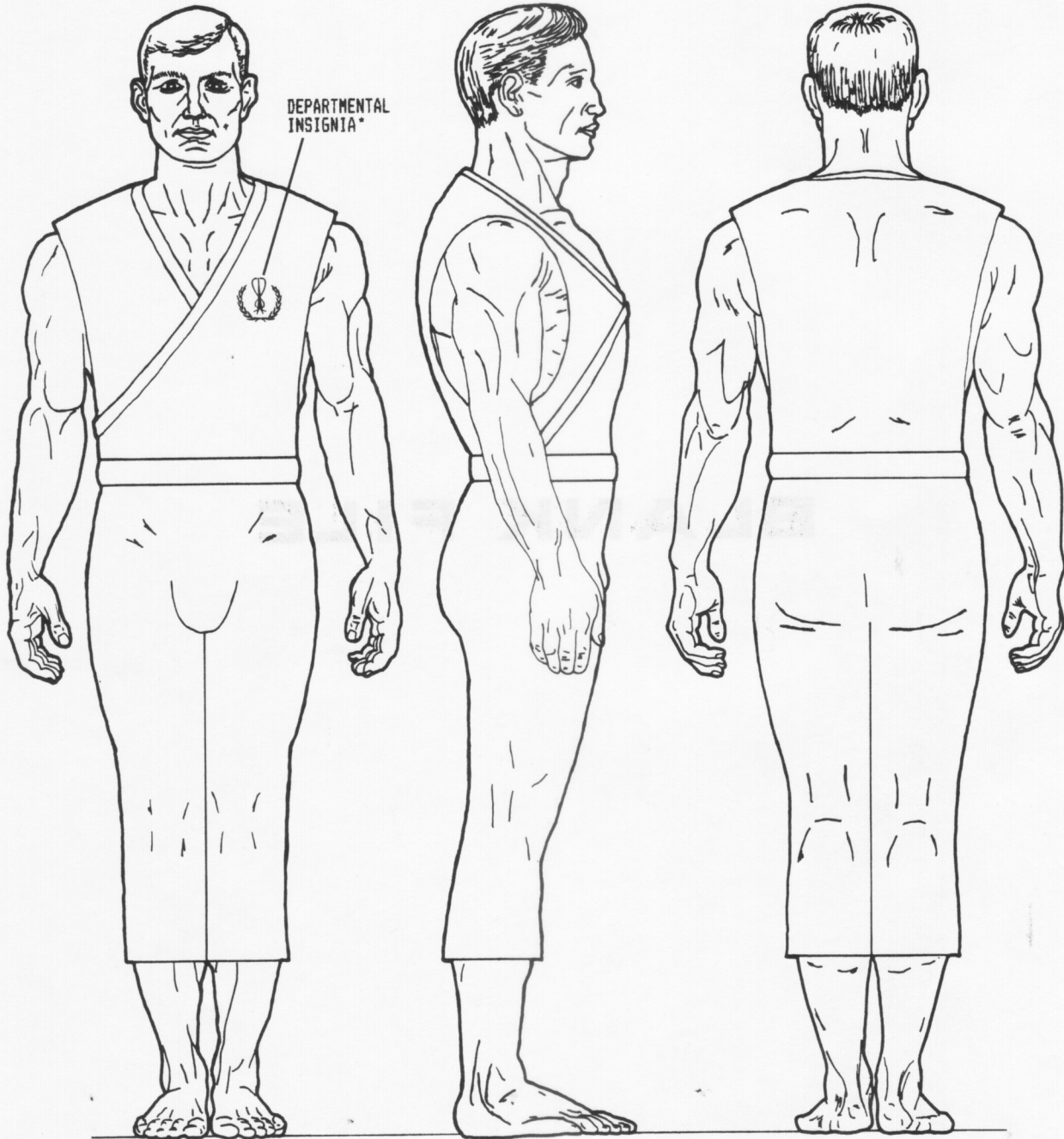

 FSC 552 LIGHT GRAY BLUE

*SEE TD:01:03:01:10.01 AND TD:01:03:02:10.01

RS: 480371.4

TO:01:03:02:05.02

AUTHENTICATED STARDATE 6411.20

AMENDMENT CODE:OR

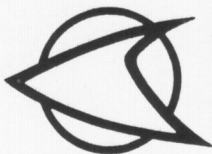

ADMINISTRATIVE ORDER

STAR FLEET UNIFORM REGULATION

BY 2260, CREW SIZES ON SOME STARSHIP TYPES HAD GROWN TO NEARLY 500 PERSONS. THIS WAS A REFLECTION OF THE INCREASING SOPHISTICATION OF THESE VESSELS AND THE MULTIPLICITY OF TASKS THEY WERE BEING CALLED UPON TO PERFORM. THE GROWTH IN SHIP COMPLEMENTS AND CREW DUTIES LED TO A GENUINE NEED FOR FURTHER RANK DELINIATION AND MARKINGS. AT THE SAME TIME, UNIFORMS WERE ALTERED TO CONFORM MORE CLOSELY WITH CONTEMPORARY FASHIONS. UNIFORM COLORS WERE BRIGHTENED IN AN ATTEMPT TO MAKE LIFE DURING LONGER SPACE VOYAGES LESS DRAB.



UNITED FEDERATION OF PLANETS

FROM: UFP/STAR FLEET DIVISION
HEADQUARTERS
PARK-PRESIDIO BOULEVARD, FORT POINT
SAN FRANCISCO, UNITED AMERICAS, EARTH DTC 76314171 GG

ATTENTION: ALL STATIONS -- UFP/STAR FLEET DIVISION PERSONNEL

SUBJECT: STAR FLEET ADMINISTRATIVE ORDER/NEW UNIFORM REGULATIONS

MESSAGE: EFFECTIVE SD 6605.20, THE FOLLOWING UNIFORMS, WORKSUIT AND SPECIAL DUTY GARMENTS WILL BECOME REGULATION ATTIRE FOR ALL STAR FLEET DIVISION PERSONNEL. ALL PERSONNEL WILL WEAR UNIFORMS AND SLEEVE MARKS REFLECTIVE OF THEIR RANK. MOBILE GROUND FORCE PERSONNEL WILL WEAR THE SAME MARKINGS FOR THEIR EQUIVALENT RANKS AND RATINGS.

CLASS A AND CLASS B TUNIC AND DRESS COLORS WILL DESIGNATE GROUP ATTACHMENT.

CLASS A DRESS UNIFORMS:
SCIENCES GROUP/STAR FLEET SCIENCES AND MEDICAL CORPS - FSC 311 GREEN BLUE
SERVICES GROUP/STAR FLEET SERVICES, SUPPLY CORPS, AND CORPS OF ENGINEERS - FSC 485 RED
DECK GROUP/STAR FLEET OFFICERS OF THE LINE - FSC 578 LIGHT GREEN
STAR FLEET MOBILE GROUND FORCE - FSC 464 BROWN

CLASS B UNDRRESS UNIFORMS:
SCIENCES GROUP/STAR FLEET SCIENCES AND MEDICAL CORPS - FSC 312 GREEN BLUE
SERVICES GROUP/STAR FLEET SERVICES, SUPPLY CORPS, AND CORPS OF ENGINEERS - FSC 485 RED
DECK GROUP/STAR FLEET OFFICERS OF THE LINE - FSC 577 LIGHT GREEN
STAR FLEET MOBILE GROUND FORCE - FSC 464 BROWN

AUTHORIZATION: SUMISU, THOMAS, RADM CHIEF PLANNING AND POLICY/
FLEET OPERATIONS

ISSUED: EARTHDATE 01 FEB 2260/STARDATE 6605.17

RS: 480371.5

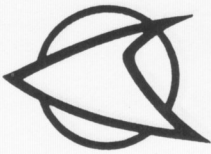

TO: 01:03:03:00:02

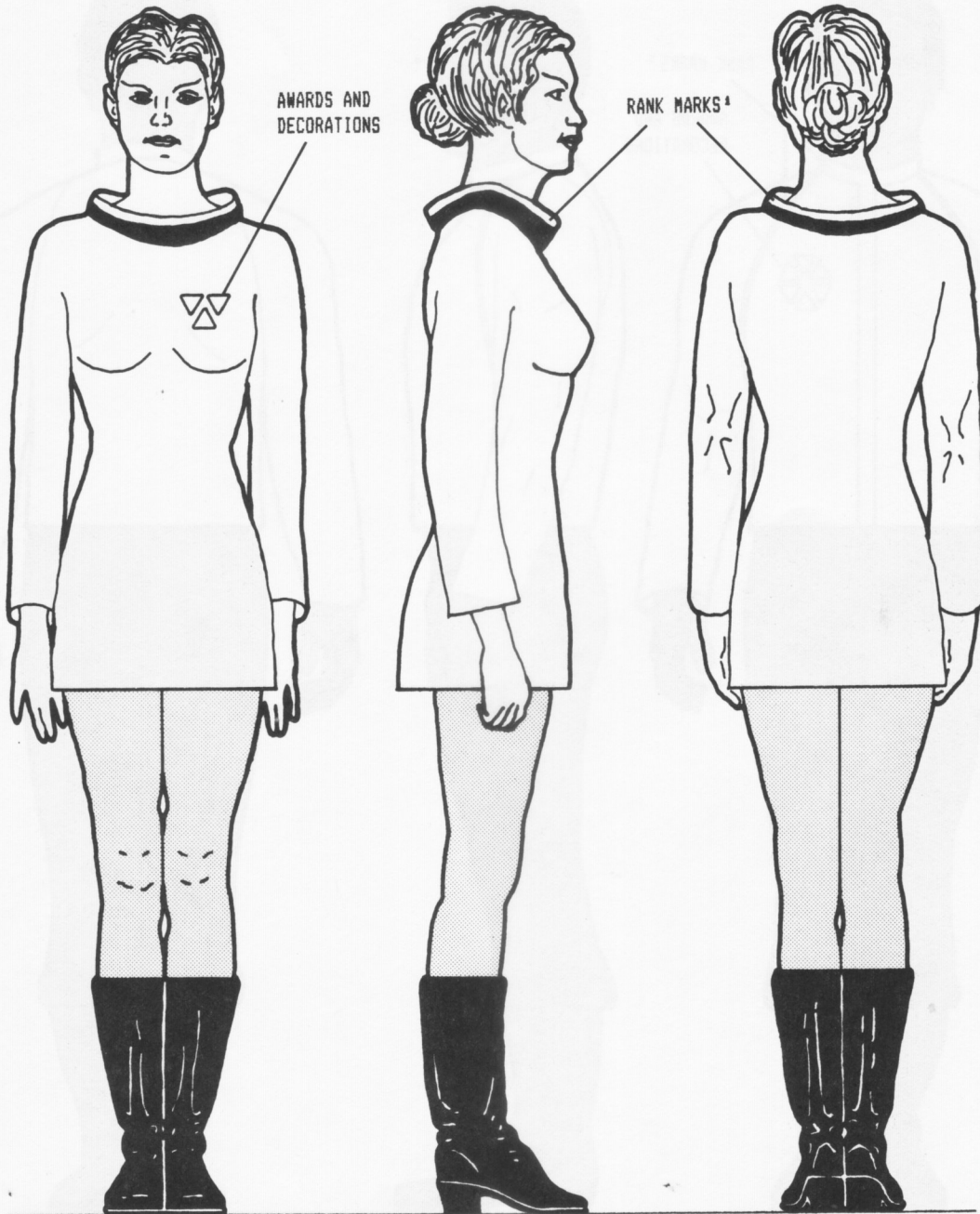

CLASS A DRESS UNIFORM

STAR FLEET - FEMALE ALL RANKS & RATINGS



-  HOSE: FSC 431 DARK GRAY
-  FSC 426 BLACK
-  GROUP COLOR: SEE TO:01:03:03:00.02

¹CREWMEN, PETTY OFFICERS, AND ENSIGN APPOINTEES - NO BRAID
 JUNIOR OFFICERS - 3 MM NARROW FSC 873 GOLD PIPING
 SENIOR OFFICERS - 20 MM WIDE FSC 873 GOLD BRAID (ABOVE)
 FLAG OFFICERS - 20 MM WIDE FSC 873 GOLD BRAID PLUS 3 MM NARROW
 FSC 873 GOLD PIPING ALONG LEFT VERTICAL SEAM

RS: 480371.5

TO:01:03:03:01.01

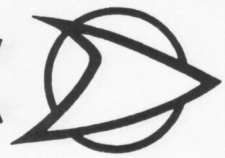

CLASS A DRESS UNIFORM



STAR FLEET - MALE ALL RANKS & RATINGS

RS: 480371.5

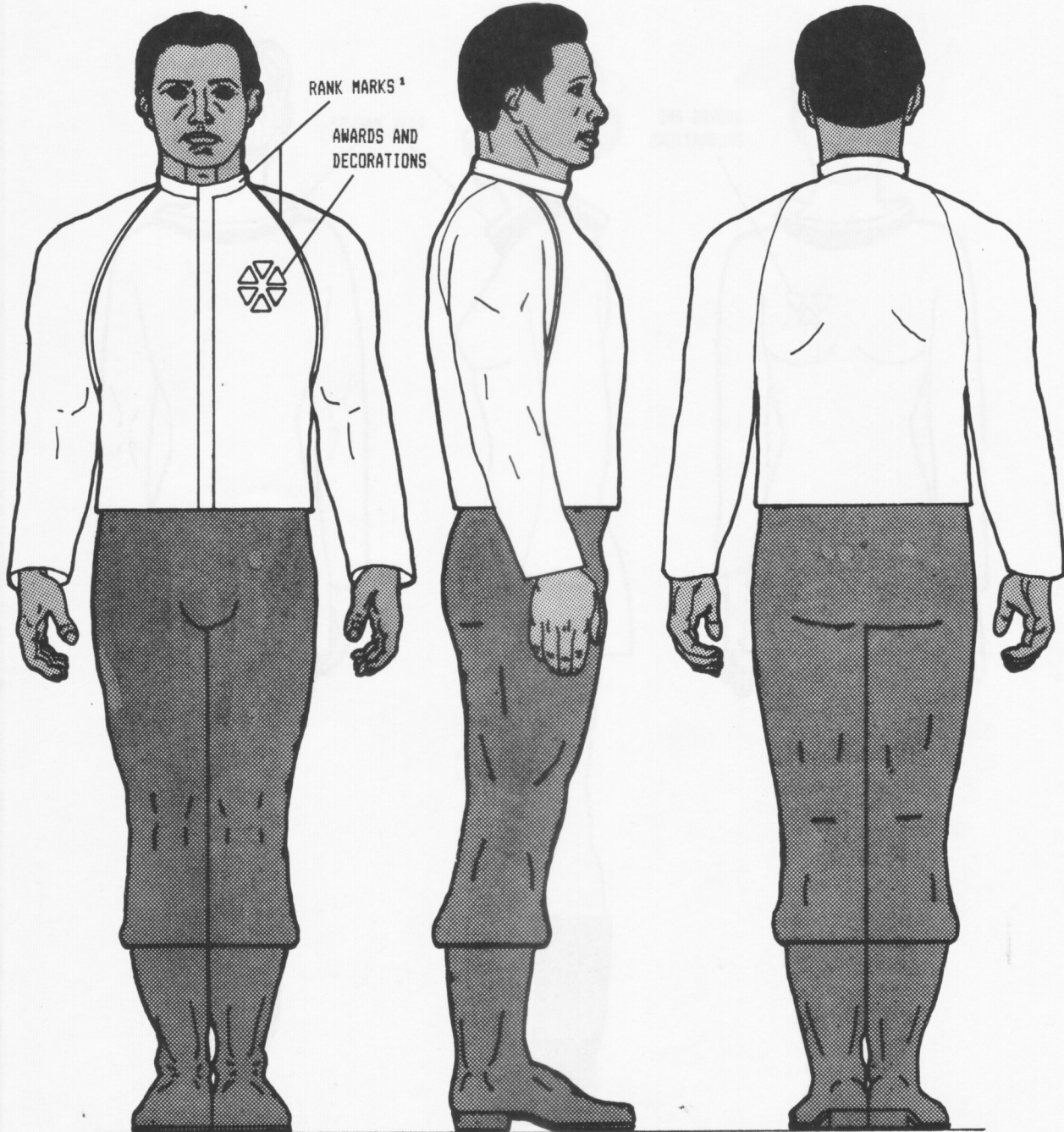
TO:01:03:03:01.02



RANK MARKS¹
 AWARDS AND
 DECORATIONS

-  FSC 426 BLACK
-  GROUP COLOR: SEE TO:01:03:03:00.02

¹ CREWMEN, PETTY OFFICERS, AND ENSIGN APPOINTEES - NO BRAID
 JUNIOR OFFICERS - 3 MM NARROW FSC 873 GOLD PIPING
 SENIOR OFFICERS - 20 MM WIDE FSC 873 GOLD BRAID
 FLAG OFFICERS - 20 MM WIDE FSC 873 GOLD BRAID PLUS 3MM NARROW
 FSC 873 GOLD PIPING ALONG FRONT VERTICAL SEAMS
 (ABOVE)

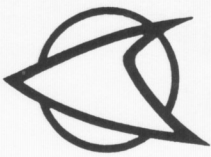

CLASS B UNDRRESS UNIFORM

STAR FLEET- FEMALE NON-COMMISSIONED OFFICERS' RATINGS

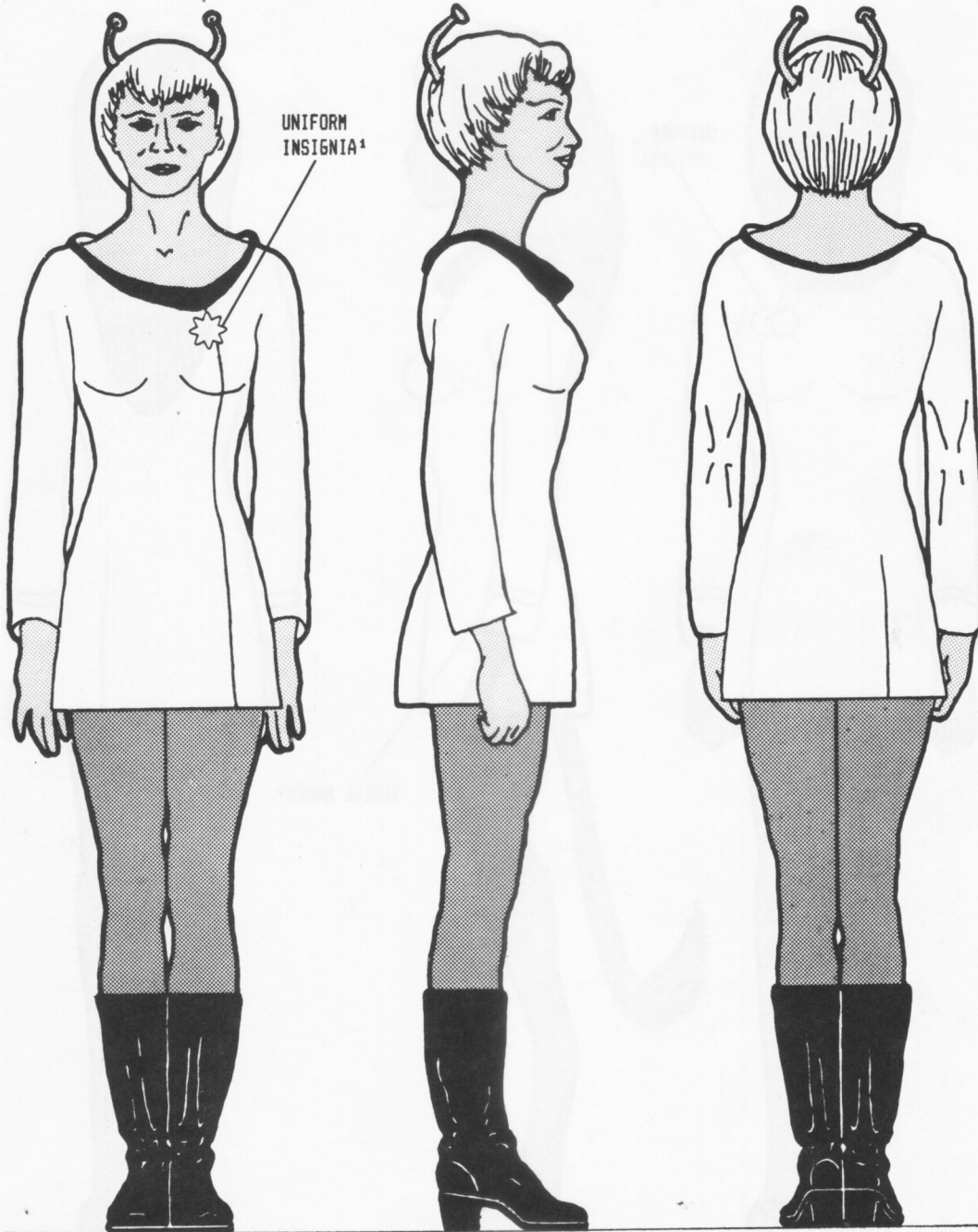

UNIFORM
INSIGNIA¹

 HOSE: FSC 431 DARK GRAY

 FSC 426 BLACK

 GROUP COLOR: SEE TO:01:03:03:00.02

¹SEE TO:01:03:03:10.01, TO:01:03:03:10.02, AND TO:01:03:03:10.03

RS: 480371.5

TO:01:03:03:02.01

AUTHENTICATED STARDATE 6605.20

AMENDMENT CODE: OR

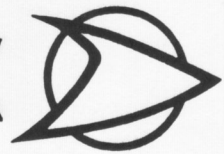

CLASS B UNDRRESS UNIFORM

STAR FLEET- FEMALE REGULAR OFFICERS' RANKS

RS: 480371.5

TO:01:03:03:02.02

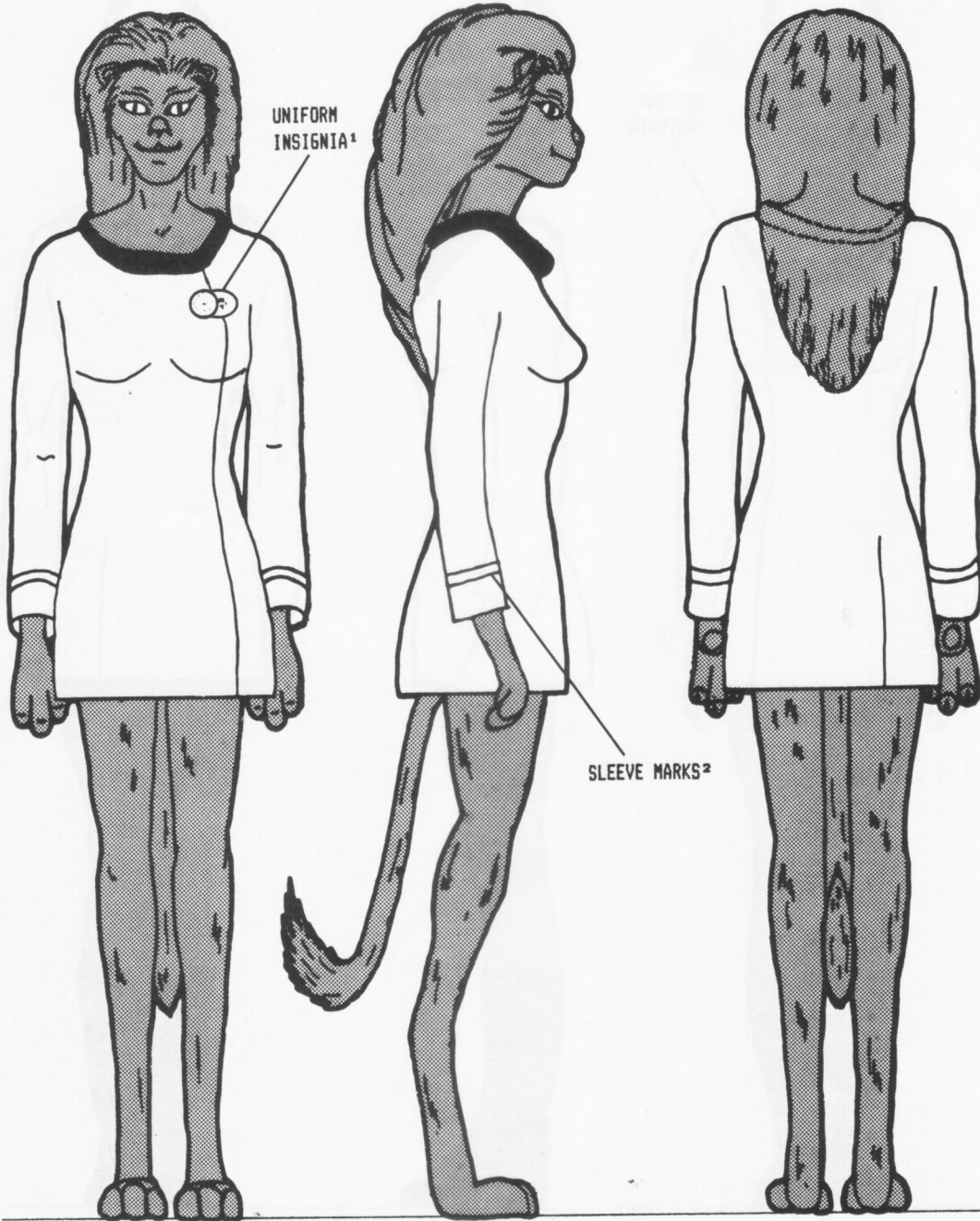

 GROUP COLOR: SEE TO:01:03:03:00.02

 FSC 426 BLACK

¹SEE TO:01:03:03:10.01, TO:01:03:03:10.02, AND TO:01:03:03:10.03

²SEE TO:01:03:03:10.01 AND TO:01:03:03:10.02

CAITIAN FEMALE ILLUSTRATED. CAITIANS ARE ONE OF THE RACES EXCEPTED FROM REGULATIONS ORDERING HUMANOID TO WEAR FOOTWEAR WHILE ON DUTY.

AMENDMENT CODE: OR

AUTHENTICATED STARDATE 6605.20

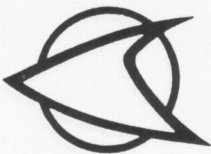

CLASS B UNDRRESS UNIFORM

STAR FLEET MEDICAL CORPS - FEMALE ALL RANKS & RATINGS

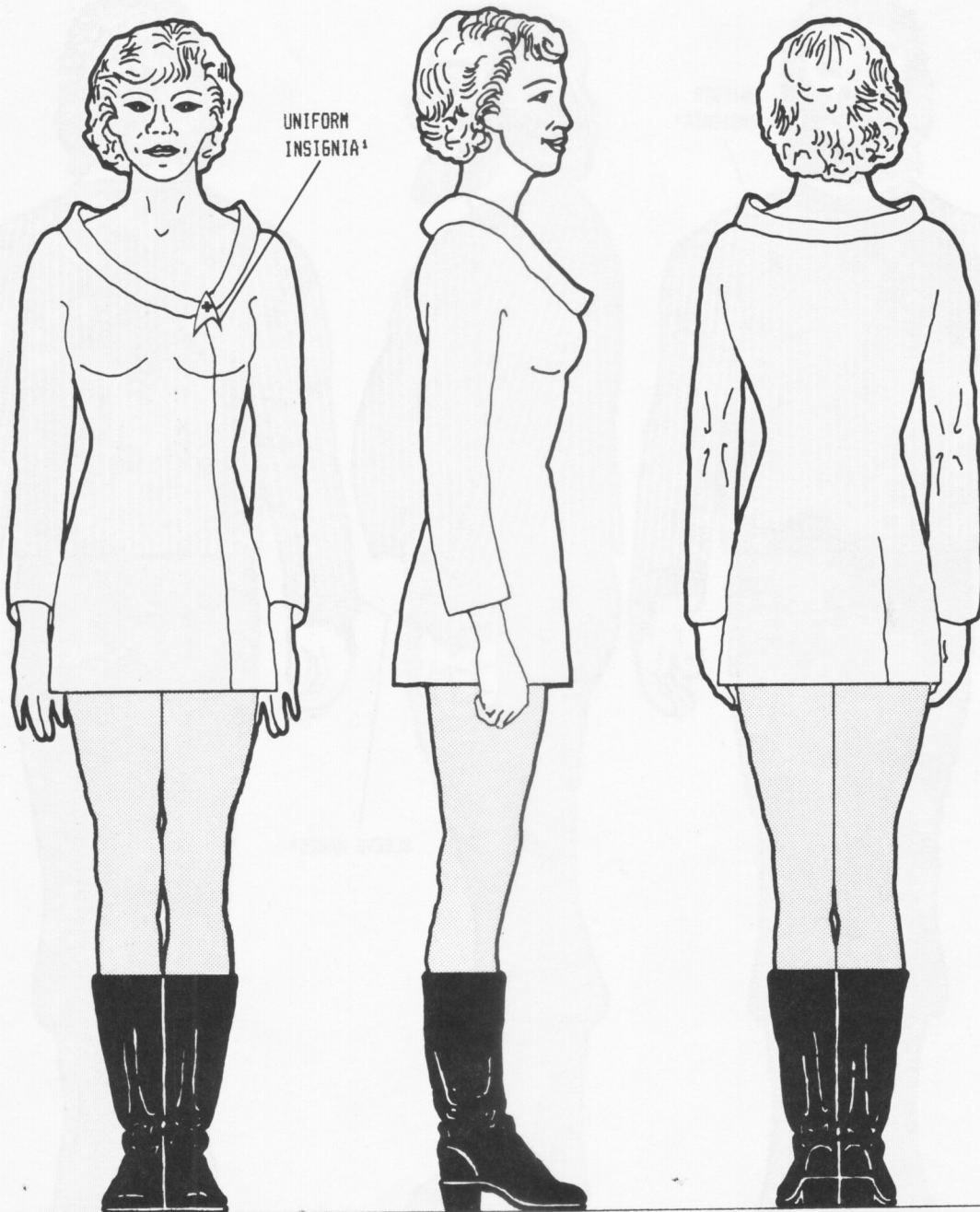

- FSC 311 GREEN BLUE
- HOSE: FSC 431 DARK GRAY
- FSC 426 BLACK

¹SEE TO:01:03:03:10.03

RS: 480371.5
TO:0 1:03:03:02.03

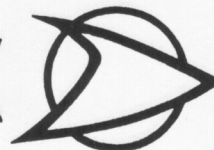

CLASS B UNDRRESS UNIFORM

STAR FLEET, UNISEX ALL MIDSHIPMEN'S RANKS

RS: 480371.5

TO:01:03:03:02.04

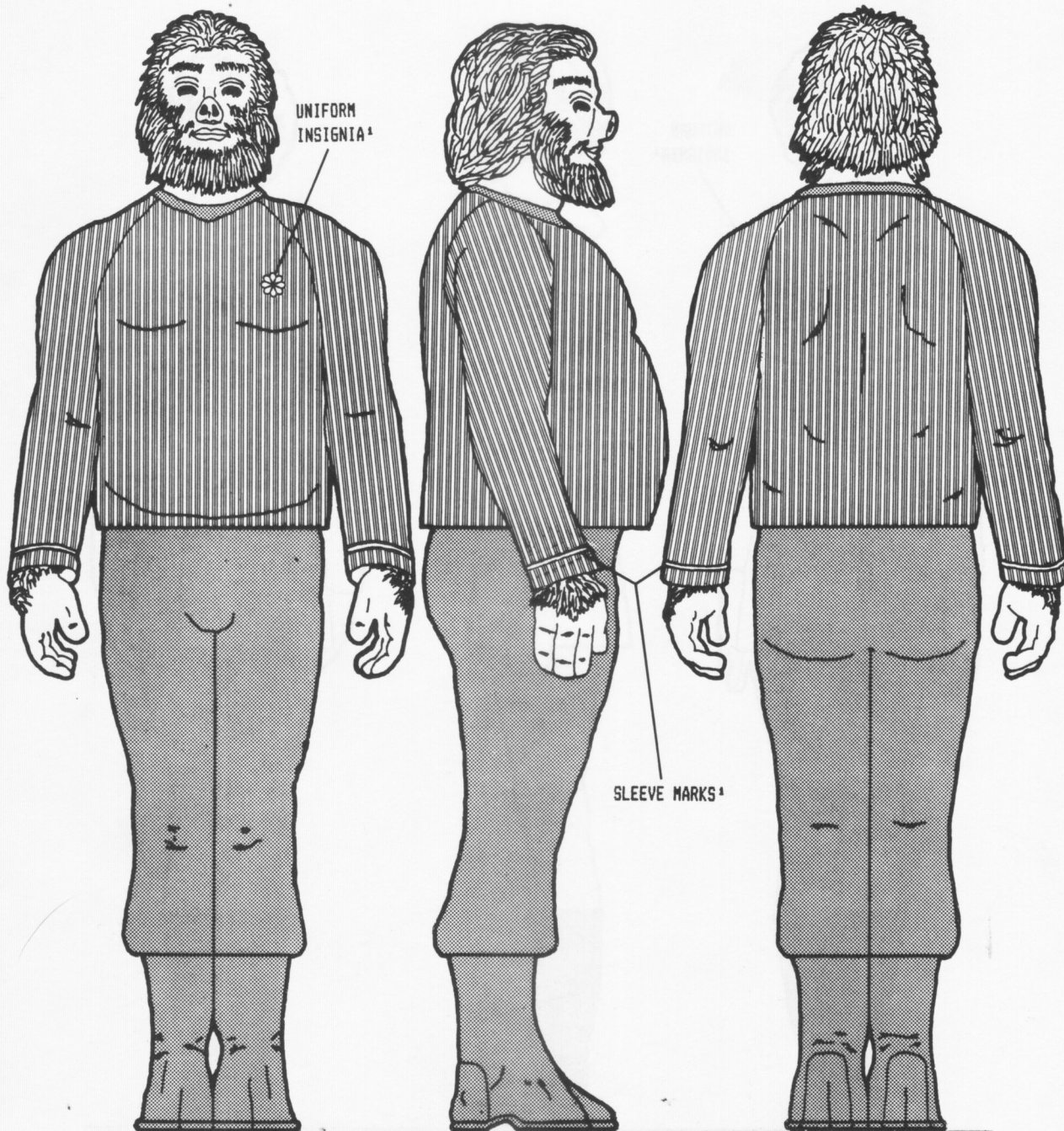

UNIFORM
INSIGNIA¹

SLEEVE MARKS¹

 FSC 297 LIGHT BLUE INTERWOVEN WITH FSC 877 SILVER

 FSC 426 BLACK

¹SEE TO:01:03:03:10.01

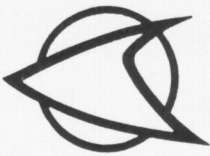

CLASS B UNDRRESS UNIFORM

STAR FLEET- MALE REGULAR & NON-COMMISSIONED OFFICERS

RS: 480371.5

TO:01:03:03:02.05

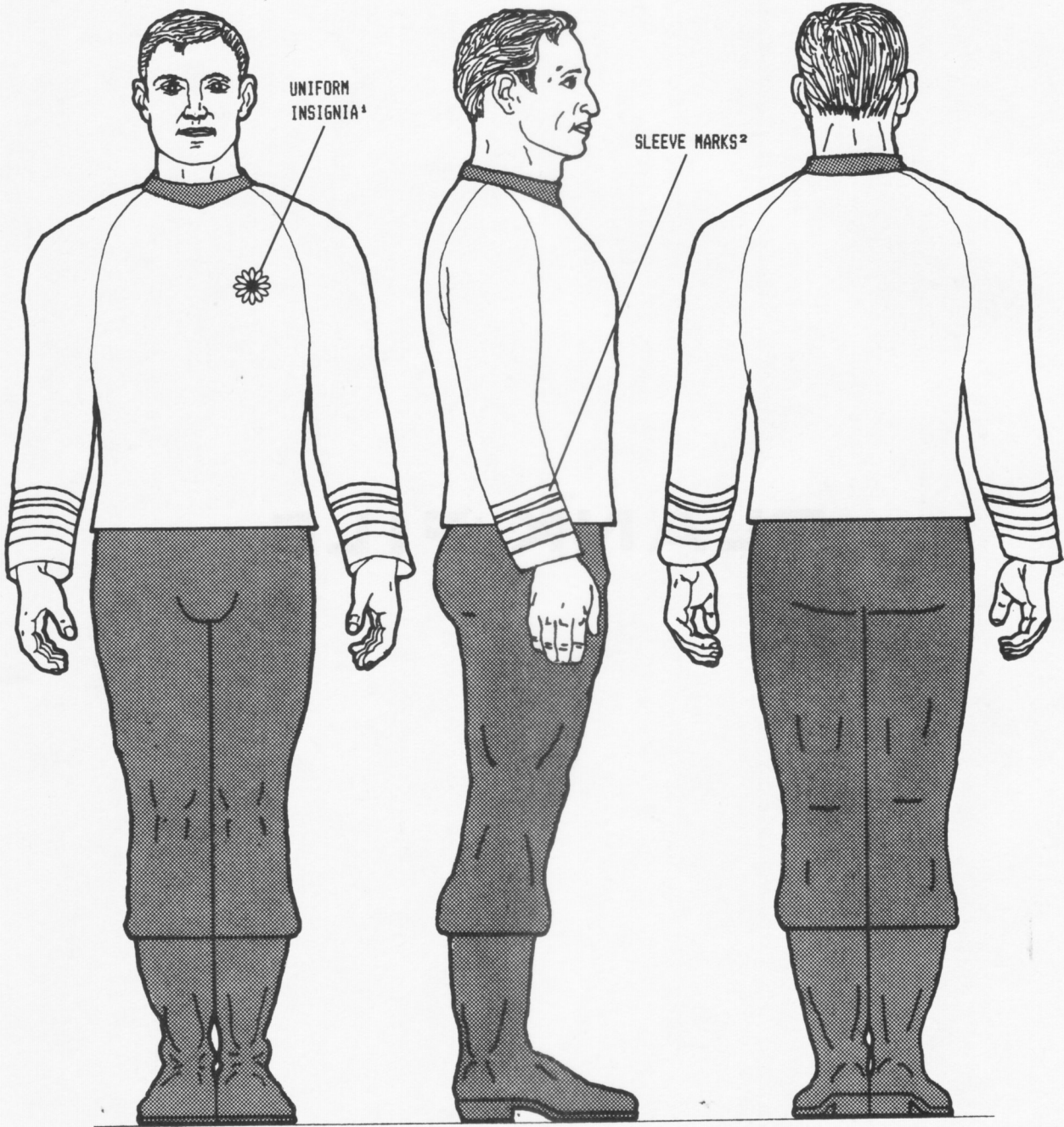

UNIFORM
INSIGNIA¹

SLEEVE MARKS²



GROUP COLOR: SEE TO:01:03:03:00.02



FSC 426 BLACK

¹SEE TO:01:03:03:10.01, TO:01:03:03:10.02, AND TO:01:03:03:10.03

²SEE TO:01:03:03:10.01 AND TO:01:03:03:10.02

AUTHENTICATED STARDATE 6605.20

AMENDMENT CODE:REVO 1

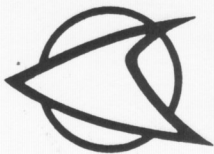

CLASS C FATIGUE UNIFORM

STAR FLEET - FEMALE NON-COMMISSIONED OFFICERS' RATINGS

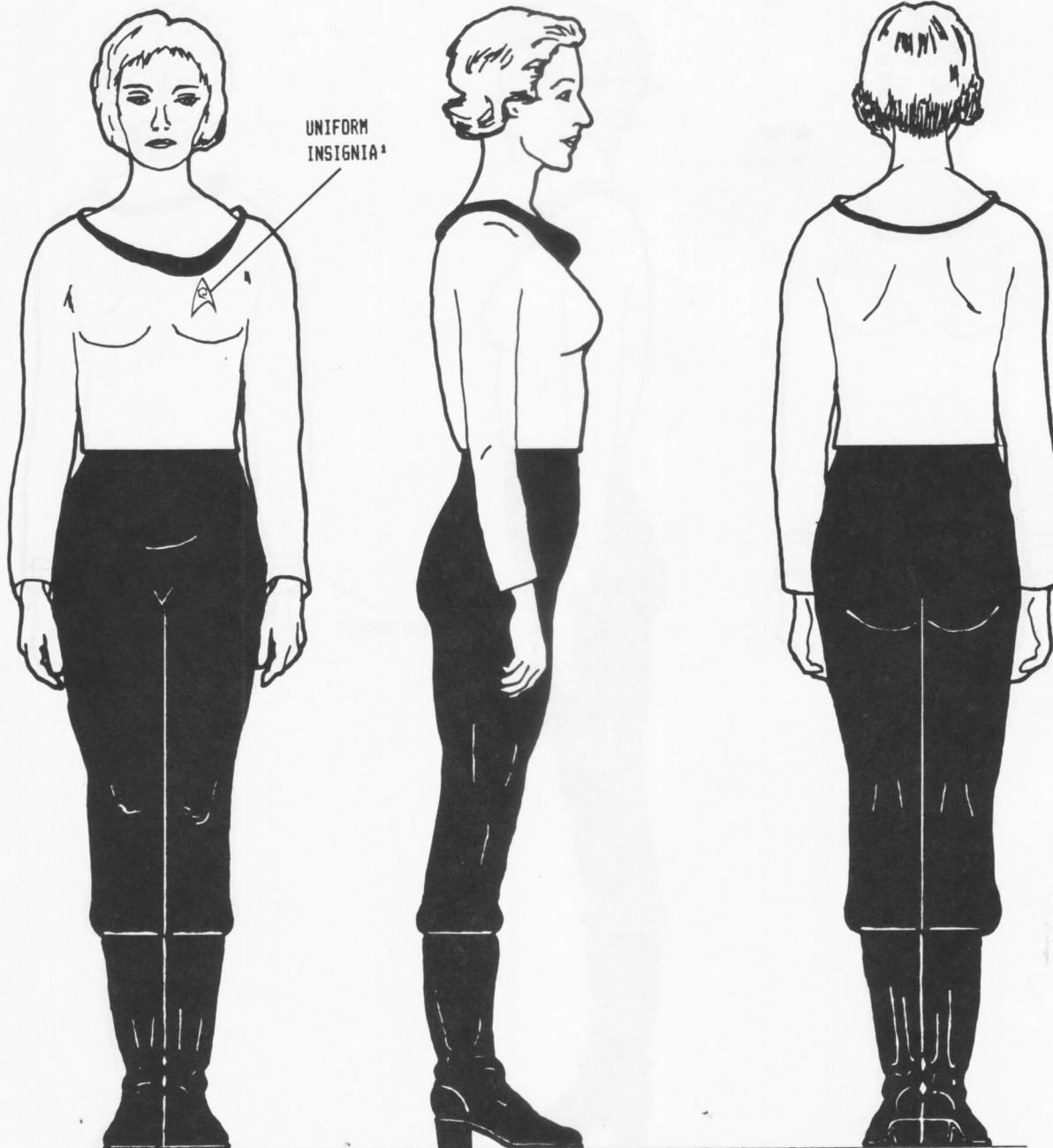

FSC 426 BLACK



FSC 110 DARK YELLOW

*SEE TO:01:03:03:10.01, TO:01:03:03:10.02, AND TO:01:03:03:10.03

RS: 480371.5

TO:01:03:03:03.01

AUTHENTICATED STARDATE 6605.20

AMENDMENT CODE: OR

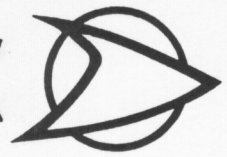

CLASS C FATIGUE UNIFORM

STAR FLEET - FEMALE REGULAR OFFICERS' RANKS

RS: 480371.5

TO:01:03:03:03.02

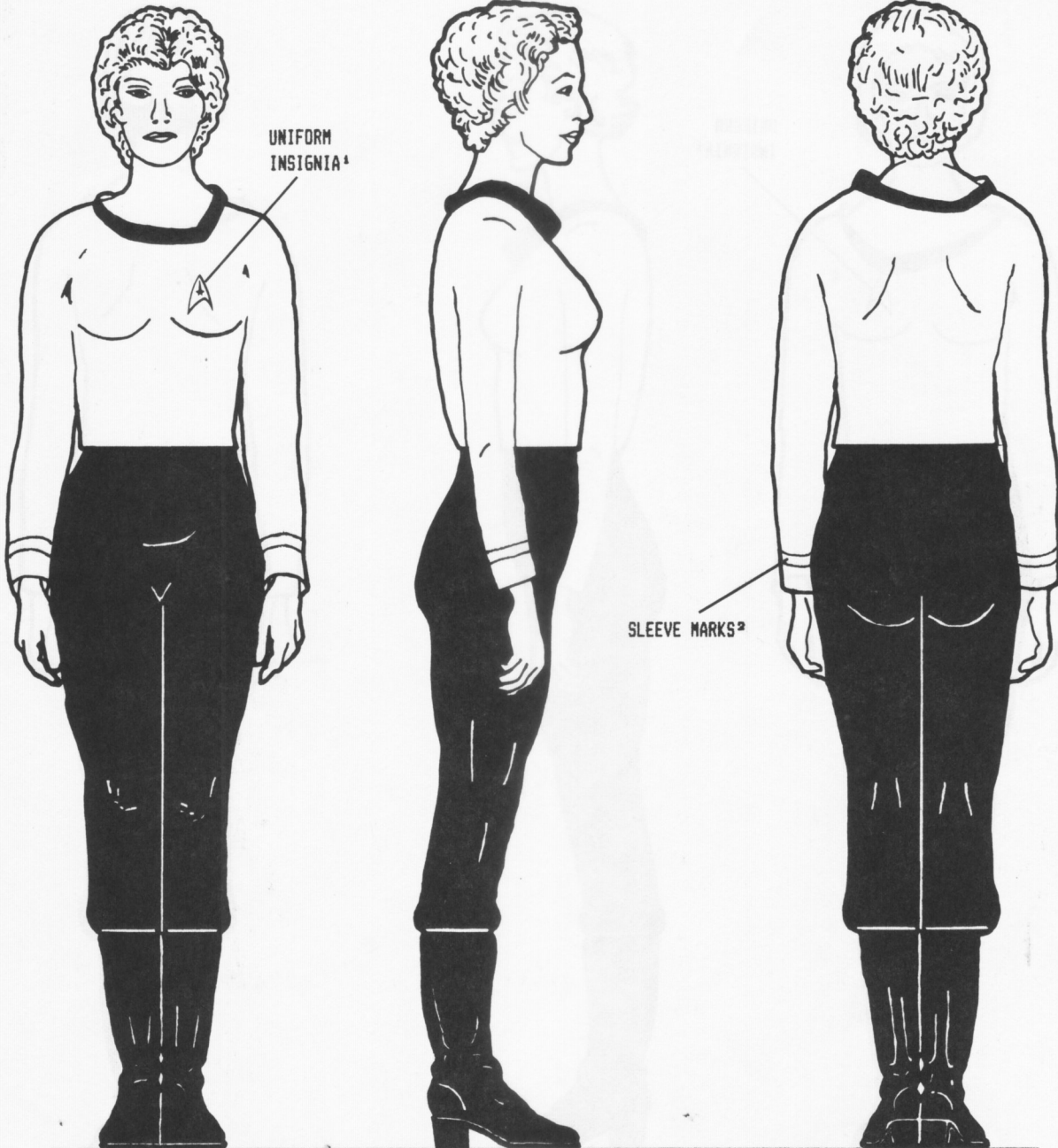

 FSC 426 BLACK

 FSC 358 LIGHT YELLOW GREEN

¹SEE TO:01:03:03:10.01, TO:01:03:03:10.02, AND TO:01:03:03:10.03

²SEE TO:01:03:03:10.01 AND TO:01:03:03:10.02

AMENDMENT CODE:OR

AUTHENTICATED STARDATE 6605.20

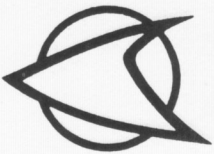

CLASS C FATIGUE UNIFORM

STAR FLEET- MALE ALL RANKS & RATINGS

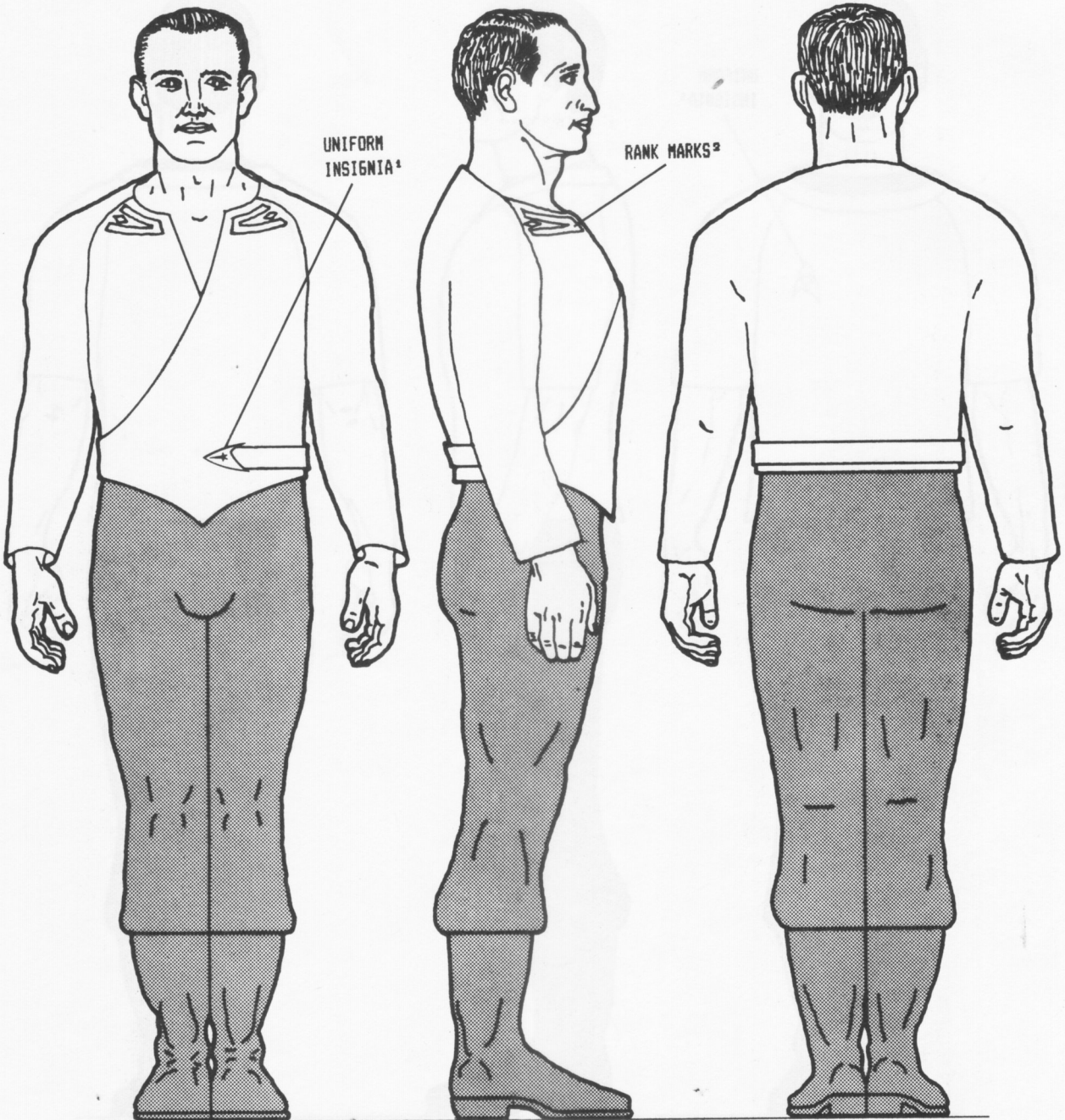

 FSC 426 BLACK

 TUNIC COLOR: NON-COMMISSIONED OFFICERS' RATINGS - FSC 110 DARK YELLOW
REGULAR OFFICERS' RANKS - FSC 358 LIGHT YELLOW GREEN

¹SEE TO:01:03:03:10.01,
TO:01:03:03:10.02, AND
TO:01:03:03:10.03

²SEE TO:01:03:03:10.04

RS: 480371.5

TO:01:03:03:03.03

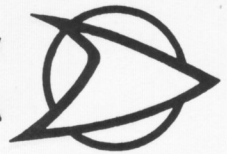



CLASS C FATIGUE UNIFORM

STAR FLEET MEDICAL CORPS- UNISEX REGULAR OFFICERS' RANKS

RS: 480371.5

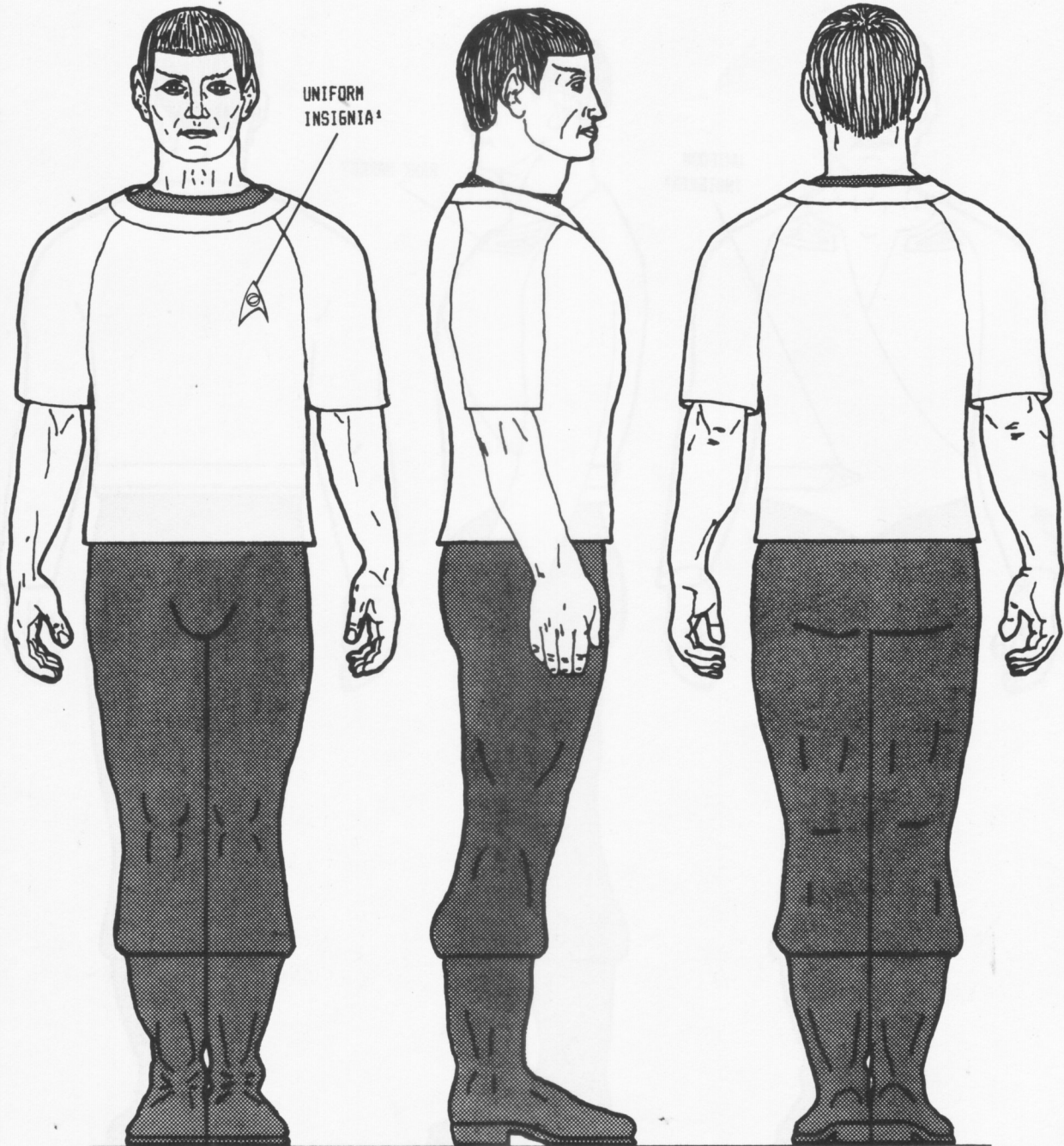
TO:01:03:03:03.04



-  TUNIC COLOR: FSC 311 GREEN BLUE
-  FSC 426 BLACK

¹SEE TO:01:03:03:10.03

AMENDMENT CODE: OR

AUTHENTICATED STARDATE 6605.20

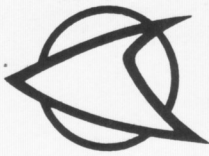

CLASS C FATIGUE UNIFORM

STAR FLEET - MALE ALL RANKS & RATINGS

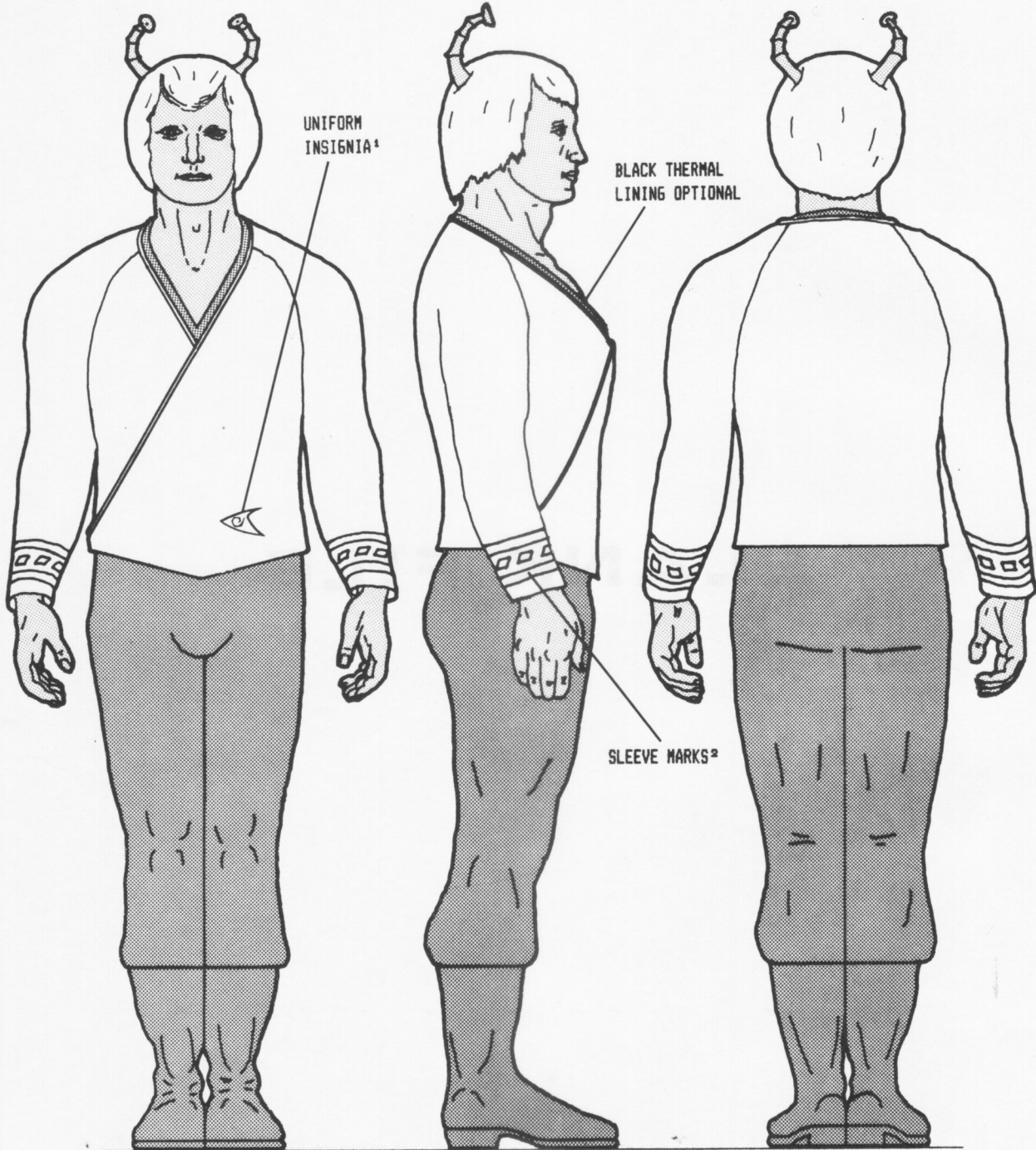

FSC 426 BLACK



TUNIC COLOR: NON-COMMISSIONED OFFICERS' RATINGS - FSC 110 DARK YELLOW
REGULAR OFFICERS' RANKS - FSC 338 LIGHT BLUE GREEN

¹SEE TO:01:03:03:10.01,
TO:01:03:03:10.02, AND
TO:01:03:03:10.03

²SEE TO:01:03:03:10.01
AND TO:01:03:03:10.02

RS: 480371.5

TO:01:03:04:03.01

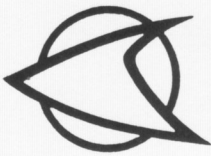

CLASS D WORKSUIT

STAR FLEET - UNISEX ALL RANKS & RATINGS

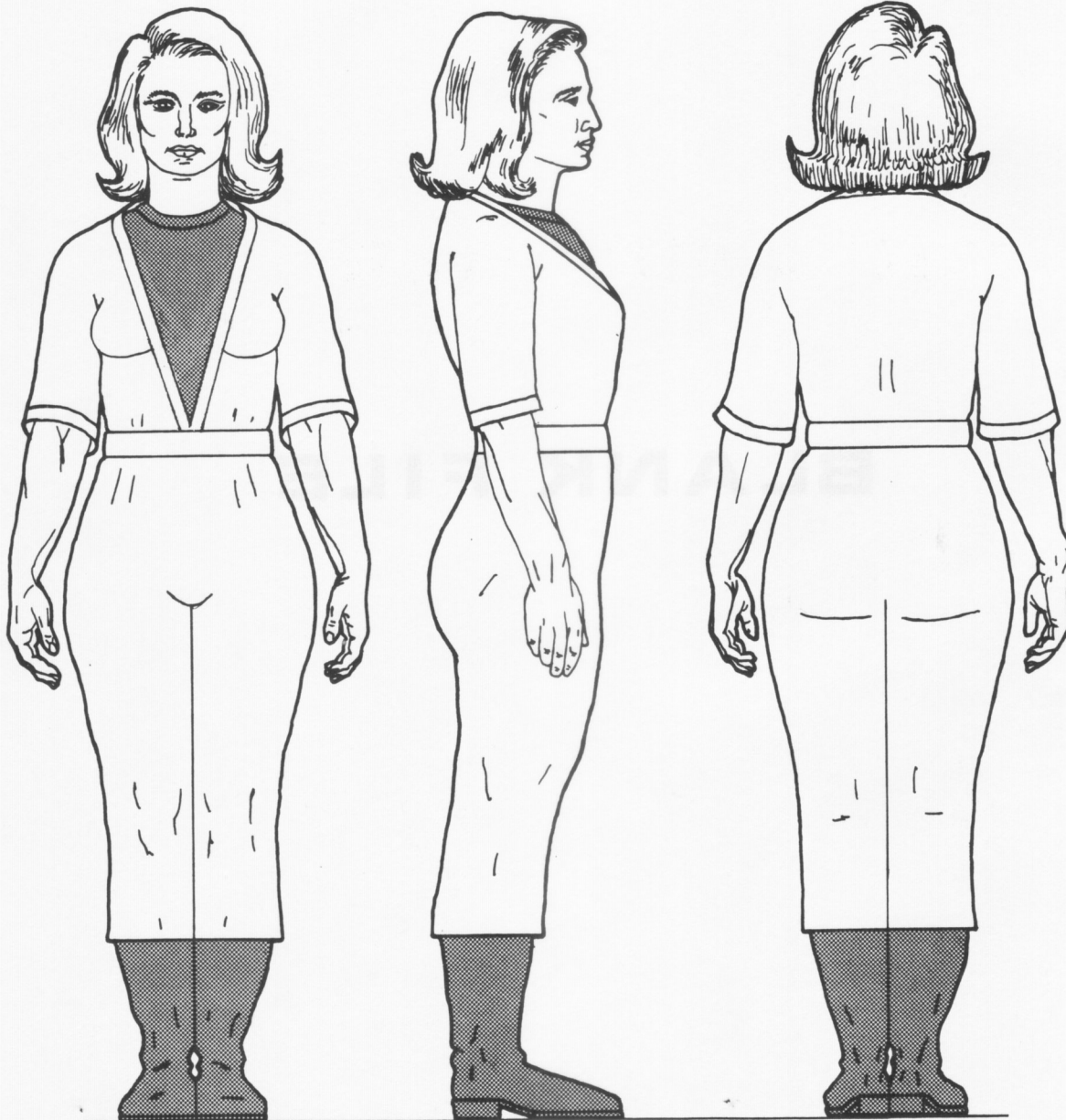

FSC 426 BLACK



GROUP COLOR: SCIENCES GROUP/STAR FLEET SCIENCES AND MEDICAL CORPS - FSC 311 GREEN BLUE
SERVICES GROUP/STAR FLEET SERVICES, SUPPLY CORPS, AND CORPS OF ENGINEERS - FSC 485 RED
DECK GROUP/STAR FLEET OFFICERS OF THE LINE - FSC 583 LIGHT OLIVE
STAR FLEET MOBILE GROUND FORCE - FSC 464 BROWN

RS: 480371.5

TO: 01:03:03:04.01



ADMINISTRATIVE ORDER

STAR FLEET UNIFORM REGULATION

IN 2266 STAR FLEET APPROVED THE USE OF THE ERATI CMA (CLOTHING MATERIALIZATION APPARATUS) ABOARD ALL FLEET VESSELS AND SHORE ESTABLISHMENTS. THESE UNITS WERE A FURTHER STEP IN THE EVOLUTION OF CLOTHING FABRICATORS THAT HAD ALREADY BEEN IN USE ABOARD STARSHIPS FOR OVER FORTY EARTH YEARS. IN THE CASE OF THE OLD UNITS, CLOTHING WAS MATERIALIZED IN A WALL-MOUNTED MULTI-FUNCTION FABRICATOR, FROM WHICH IT WAS REMOVED AND THEN PUT ON IN THE ORDINARY MANNER. WITH THE NEW UNITS HOWEVER, THE CLOTHING WAS METERIALIZED DIRECTLY ON THE WEARER WHILE STANDING IN A COMBINATION SONIC SHOWER/CLOTHING FABRICATOR. THIS METHOD OF DRESSING PERMITTED A COMPLETELY DIFFERENT KIND OF UNIFORM TO BE DESIGNED, AS CAN BE SEEN IN TECHNICAL ORDER SERIES 01:03:05. AT THE SAME TIME, INSIGNIA WERE ALTERED TO REFLECT CORPS COLOR, INSTEAD OF GROUP COLOR AS WAS INDICATED ON THE OLD TUNICS AND DRESSES. FINALLY, THE NEW UNIFORM COLORS DESIGNATED OFFICER RANK GROUPINGS, I.E. NONCOMMISSIONED, JUNIOR, AND SENIOR OFFICERS.



FROM: UFP/STAR FLEET DIVISION
BUREAU OF OPERATIONS - OFFICE OF ADMINISTRATION
HEADQUARTERS
PARK PRESIDIO BOULEVARD, FORT POINT
SAN FRANCISCO, UNITED AMERICAS, EARTH DTC 76314178 GG

ATTENTION: ALL STATIONS - UFP/STAR FLEET DIVISION PERSONNEL

SUBJECT: STAR FLEET ADMINISTRATIVE ORDER/NEW UNIFORM REGULATIONS

MESSAGE: EFFECTIVE SD 7912.07, THE ERATI CLOTHING MATERIALIZATION APPARATUS WILL BE APPROVED FOR INSTALLATION ON DESIGNATED STAR FLEET VESSELS AND SHORE ESTABLISHMENTS. AS THESE UNITS ARE INSTALLED, PERSONS WHOSE ASSIGNED STATIONS ARE SO SERVICED WILL WEAR THE UNIFORMS, WORKSUITS, AND SPECIAL DUTY GARMENTS COVERED IN TECHNICAL ORDER SERIES 01:03:05. EXCEPT WHERE NOTED, EXISTING RANK DESIGNATIONS REMAIN IN FORCE. INSIGNIA FOR OPERATING FORCES PERSONNEL WILL HENCEFORTH REFLECT THE CHANGES ILLUSTRATED IN TO:01:03:05:20.01. RANK EPAULETS, ALSO ILLUSTRATED IN TO:01:03:05:20.01, WILL BE WORN ON DESIGNATED UNIFORMS, WORKSUITS AND SPECIAL DUTY GARMENTS. BACKGROUND COLORS FOR THESE INSIGNIA AND EPAULETS WILL REFLECT STAR FLEET CORPS ATTACHMENT:

- STAR FLEET SCIENCES - FSC 164 ORANGE
- STAR FLEET CORPS OF ENGINEERS - FSC 485 RED
- STAR FLEET OFFICERS OF THE LINE - FSC 001 WHITE
- STAR FLEET MEDICAL CORPS - FSC 354 GREEN
- STAR FLEET SERVICES - FSC 122 PALE GOLD
- STAR FLEET JUDGE ADVOCATE GENERAL'S CORPS/SECURITY FORCES-FSC 429 GRAY
- STAR FLEET SUPPLY CORPS - FSC 527 PURPLE
- STAR FLEET MOBILE GROUND FORCE - FSC 464 BROWN

AUTHORIZATION: KLENTA'AR RADM DIRECTOR OF ADMINISTRATION

ISSUED: 13 FEB 2266/STARDATE 7912.04

RS: 480371.6

TO: 01:03:05:00.02



CLASS A DRESS UNIFORM

STAR FLEET - UNISEX ALL RANKS & RATINGS

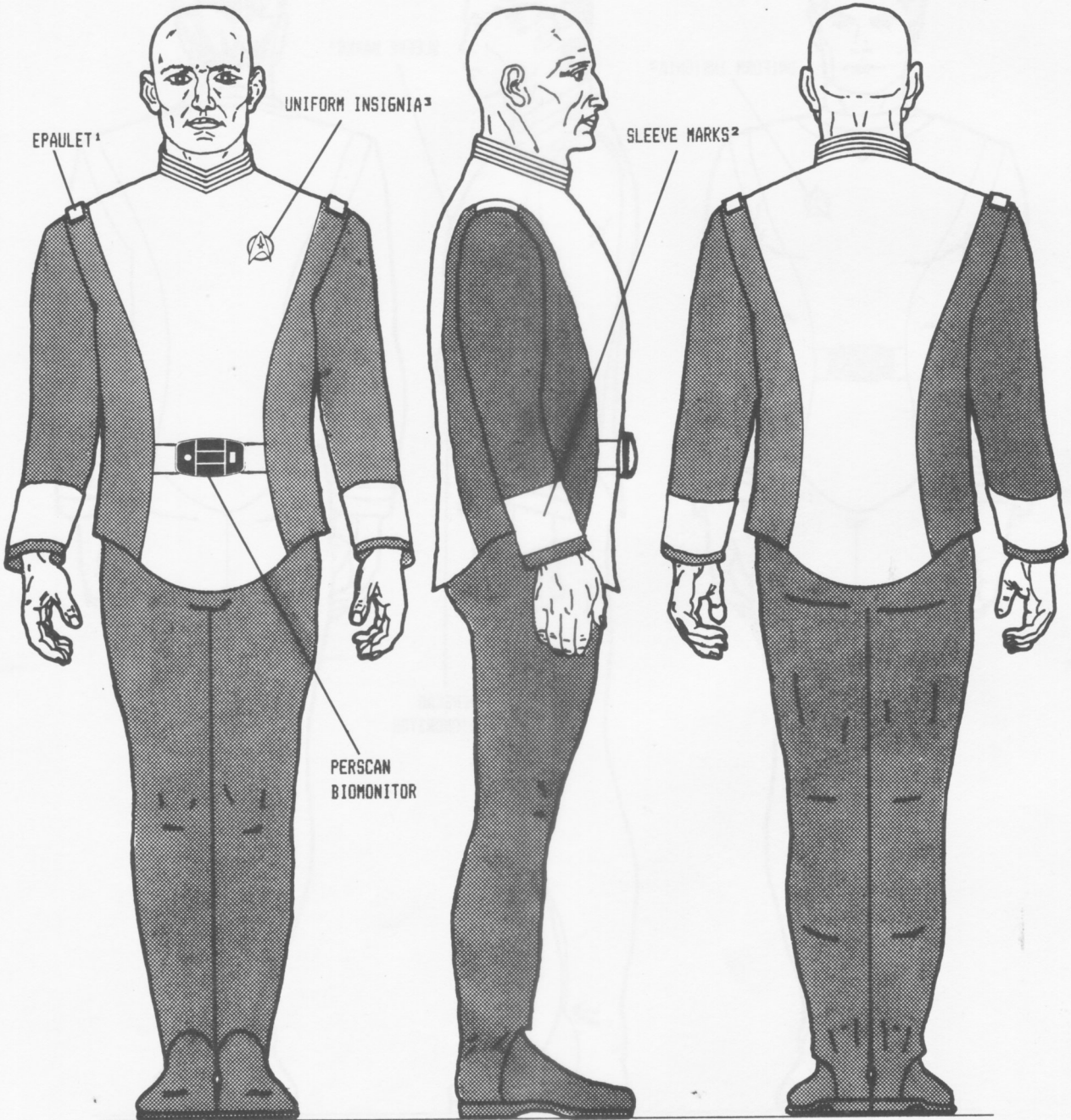

FSC 001 WHITE
 FSC 555 GRAY GREEN

¹SEE TO:01:03:05:20.01
 ²SEE TO:01:03:05:10.01 AND TO:01:03:05:10.02
 ³SEE TO:01:03:05:10.03 AND TO:01:03:05:20.01

RS: 480371.6

TO:01:03:05:01.01



CLASS B UNDRRESS UNIFORM

STAR FLEET - UNISEX ALL RANKS & RATINGS (TYPE ONE)

RS: 480371.6

TO:01:03:05:02.01

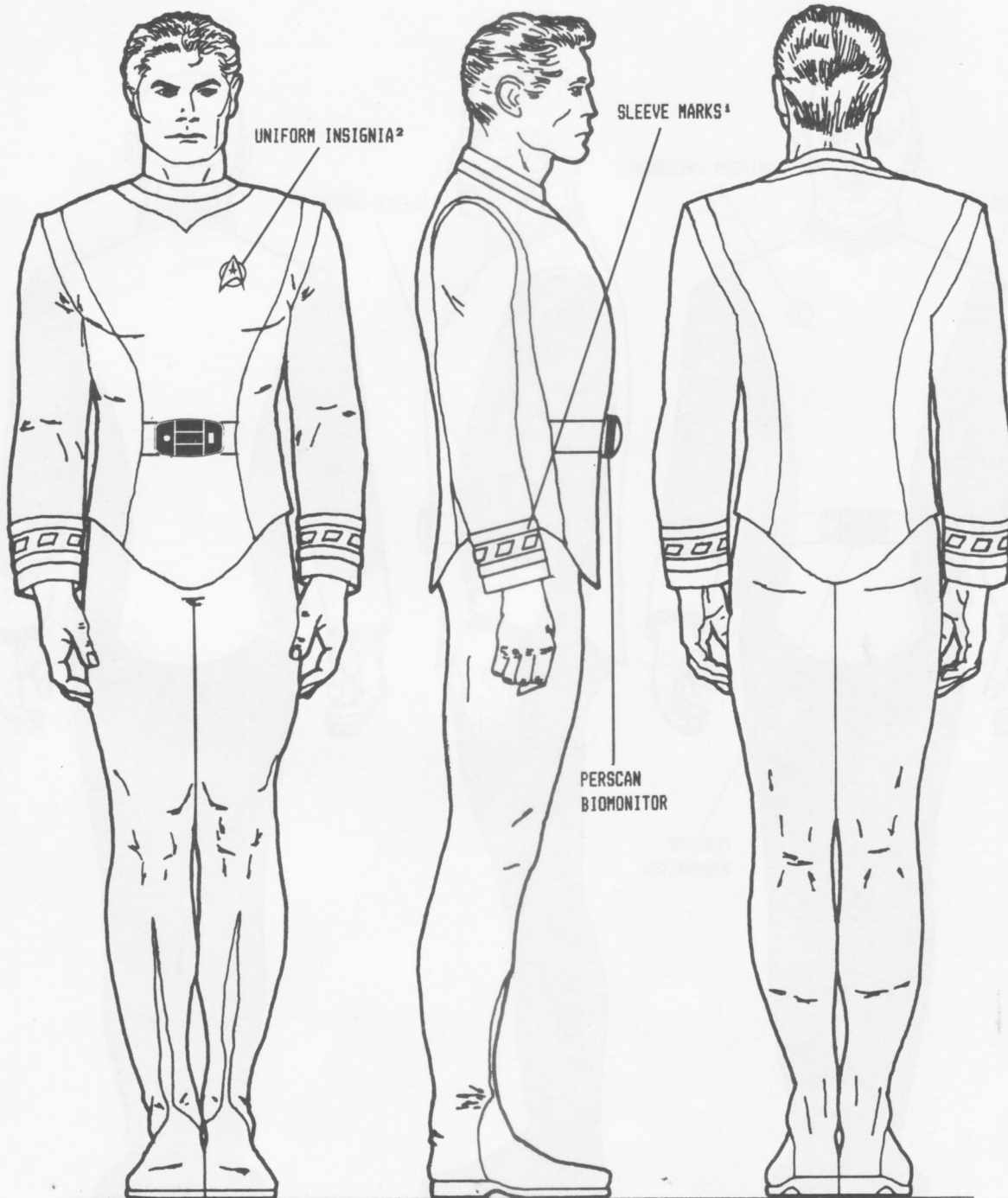

UNIFORM COLOR: NON-COMMISSIONED RATINGS - FSC 448 BROWN
 JUNIOR OFFICERS' RANKS - FSC 128 BEIGE
 SENIOR OFFICERS' RANKS - FSC 297 PALE BLUE GRAY

¹SEE TO 01:03:05:10.01 AND TO:01:03:05:10.02

²SEE TO 01:03:05:10.03 AND TO:01:03:05:20.01

AMENDMENT CODE:REV02

AUTHENTICATED STARDATE 7912.07



CLASS B UNDRRESS UNIFORM

STAR FLEET - UNISEX ALL RANKS & RATINGS (TYPE TWO)

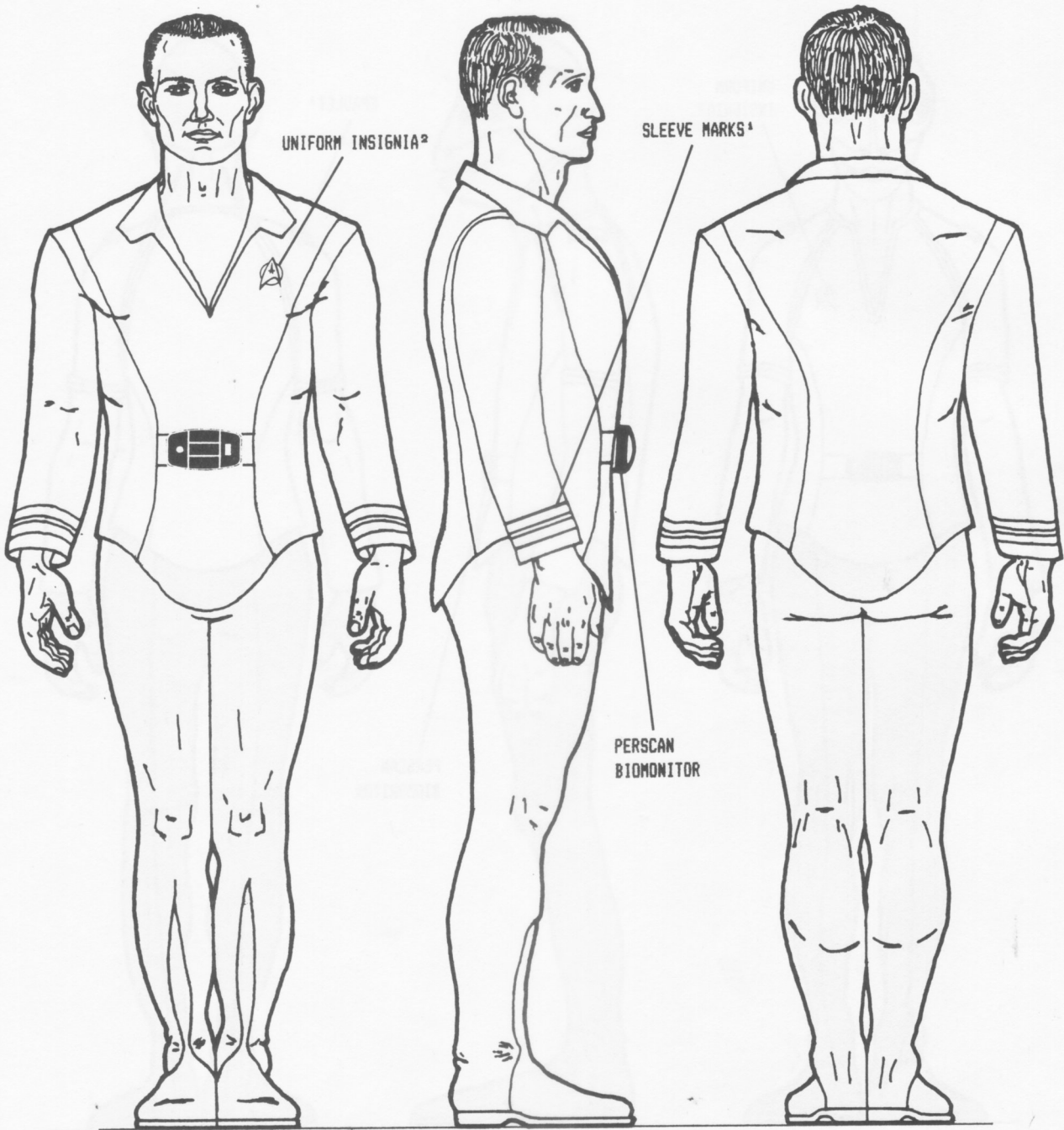

UNIFORM COLOR: NON-COMMISSIONED RATINGS - FSC 448 BROWN
 JUNIOR OFFICERS' RANKS - FSC 128 BEIGE
 SENIOR OFFICERS' RANKS - FSC 297 PALE BLUE GRAY

¹SEE TO 01:03:05:10.01 AND TO:01:03:05:10.02

²SEE TO 01:03:05:10.03 AND TO:01:03:05:20.01

RS: 480371.6

TO:01:03:05:02.02



CLASS C FATIGUE UNIFORM

STAR FLEET-UNISEX ALL RANKS & RATINGS (TYPE ONE)

RS: 480371.6

TO:01:03:05:03.01

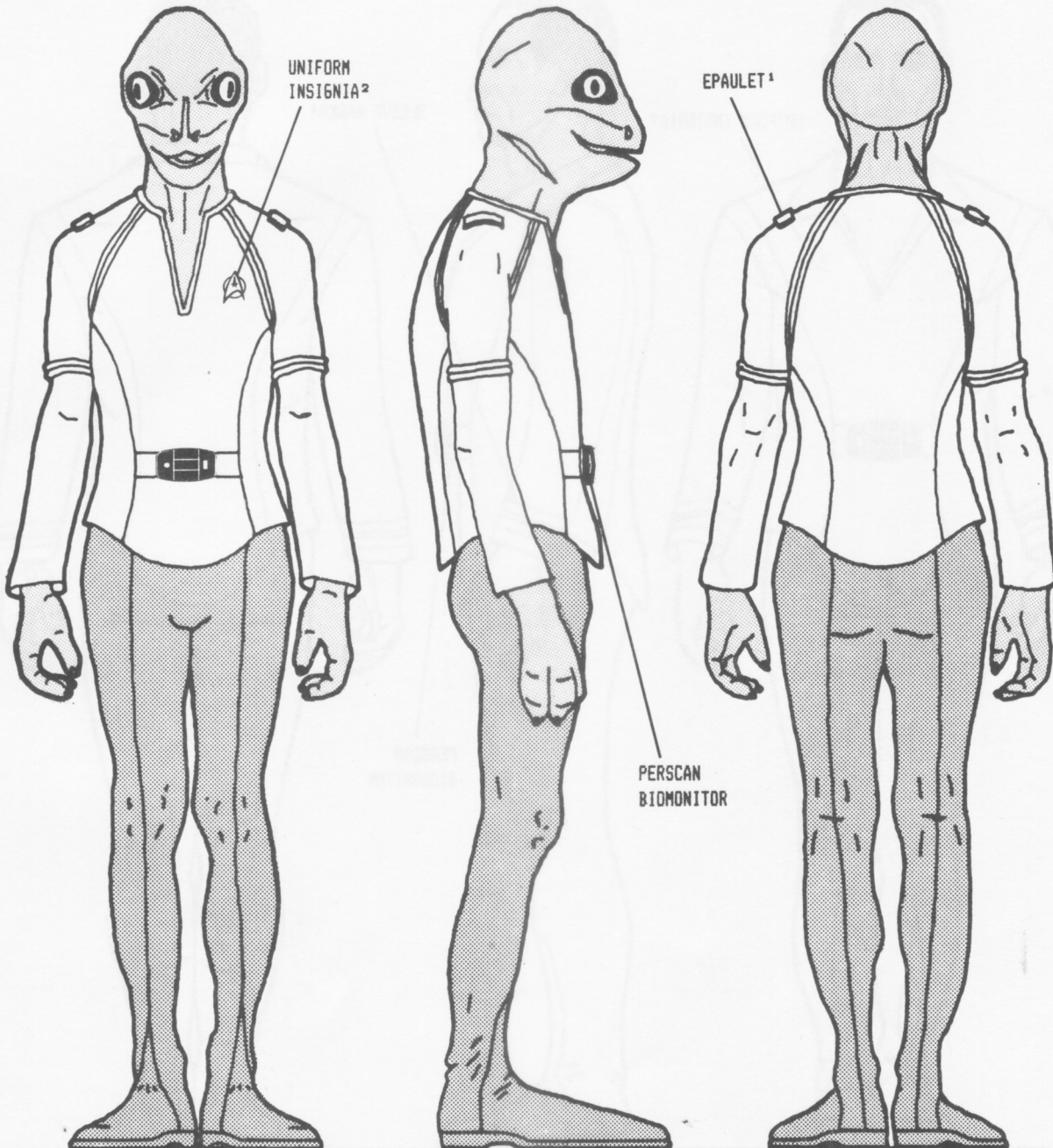

TUNIC COLOR: NON-COMMISSIONED RATINGS - FSC 448 BROWN; JUNIOR OFFICERS' RANKS - FSC 468 TAN; SENIOR OFFICERS' RANKS - FSC 001 WHITE

PANTS COLOR: NON-COMMISSIONED RATINGS - FSC 448 BROWN; JUNIOR OFFICERS' RANKS - FSC 128 BEIGE; SENIOR OFFICERS' RANKS - FSC 297 PALE BLUE GRAY; MEDICAL DEPARTMENT - FSC 001 WHITE

¹SEE TO:01:03:05:20.01
²SEE TO:01:03:05:10.03 AND TO:01:03:05:20.01



CLASS C FATIGUE UNIFORM

STAR FLEET - UNISEX ALL RANKS & RATINGS (TYPE TWO)

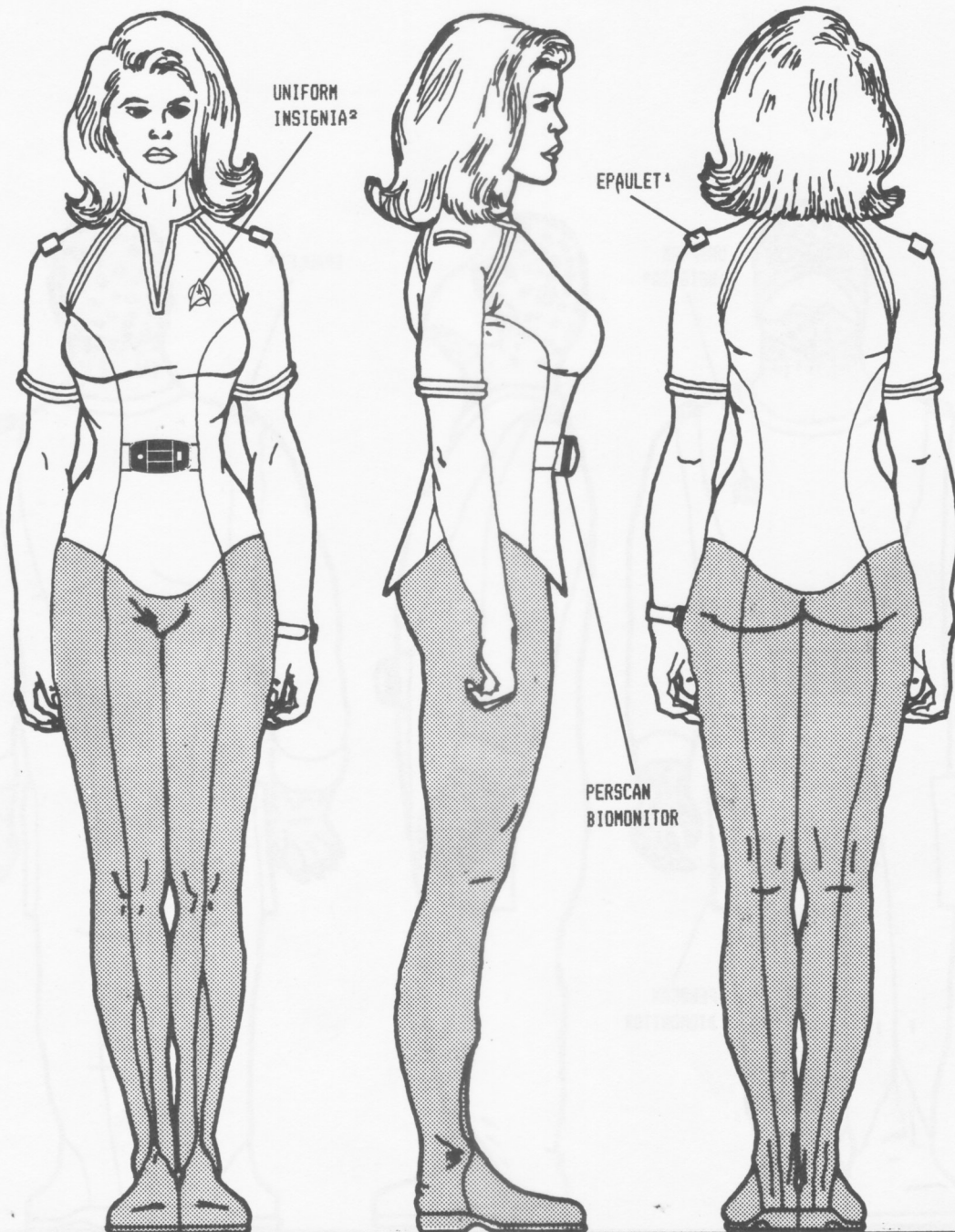

TUNIC COLOR: NON-COMMISSIONED RATINGS - FSC 448 BROWN; JUNIOR OFFICERS' RANKS - FSC 468 TAN; SENIOR OFFICERS' RANKS - FSC 001 WHITE
 PANTS COLOR: NON-COMMISSIONED RATINGS - FSC 448 BROWN; JUNIOR OFFICERS' RANKS - FSC 128 BEIGE; SENIOR OFFICERS' RANKS - FSC 297 PALE BLUE GRAY; MEDICAL DEPARTMENT - FSC 001 WHITE

¹SEE TO:01:03:05:20.01
 ²SEE TO:01:03:05:10.03
 AND TO:01:03:05:20.01

RS: 480371.6

TO:01:03:05:03.02



CLASS D WORKSUIT

STAR FLEET- UNISEX ALL RANKS & RATINGS (TYPE ONE)

RS: 480371.6

TO:01:03:05:04.01

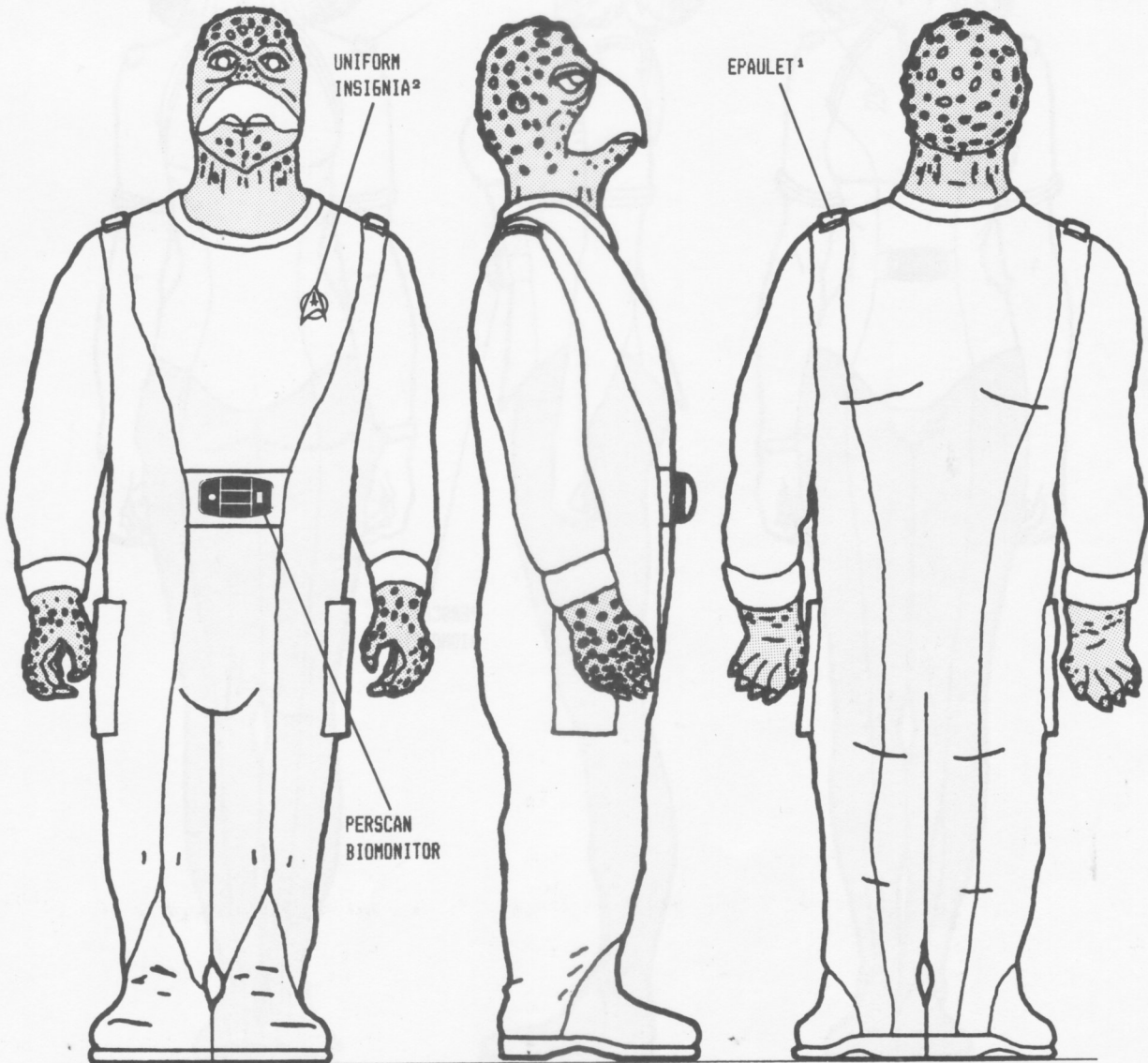

WORKSUIT COLOR: NON-COMMISSIONED RATINGS - FSC 448 BROWN
 JUNIOR OFFICERS' RANKS - FSC 128 BEIGE
 SENIOR OFFICERS' RANKS - FSC 297 PALE BLUE GRAY

¹SEE TO:01:03:05:20.01
²SEE TO:01:03:05:10.03 AND TO:01:03:05:20.01

AMENDMENT CODE:REV02

AUTHENTICATED STARDATE 7912.07



CLASS D WORKSUIT

STAR FLEET - UNISEX ALL RANKS & RATINGS (TYPE TWO)

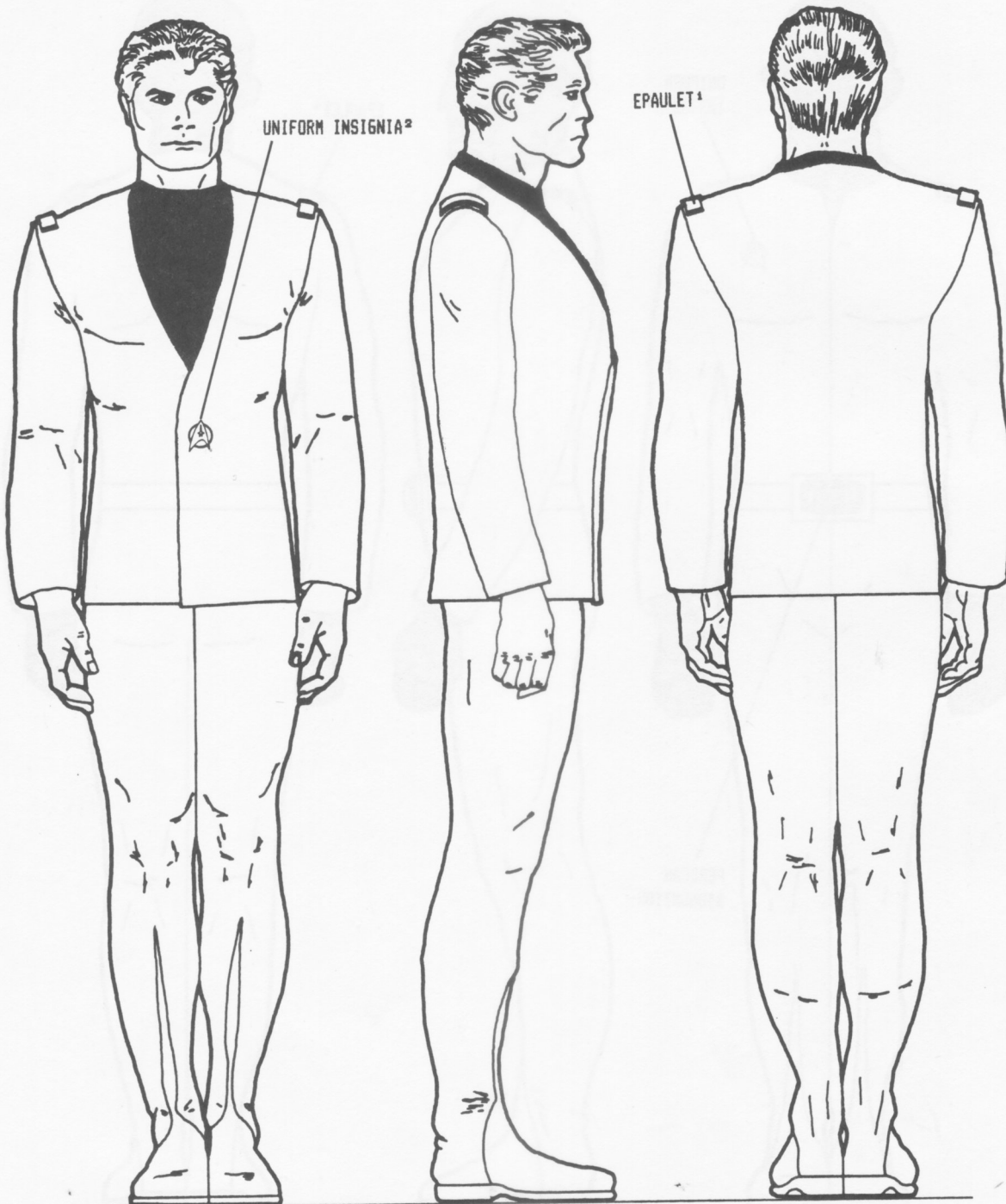

 FSC 426 BLACK

 WORKSUIT COLOR: NON-COMMISSIONED RATINGS - FSC 448 BROWN
JUNIOR OFFICERS' RANKS - FSC 128 BEIGE
SENIOR OFFICERS' RANKS - FSC 297 PALE BLUE GRAY

¹SEE TO:01:03:05:20.01

²SEE TO:01:03:05:10.03 AND TO:01:03:05:20.01

RS: 480371.6

TO:01:03:05:04.02



CLASS D WORKSUIT

STAR FLEET-UNISEX ALL RANKS & RATINGS (TYPE THREE)

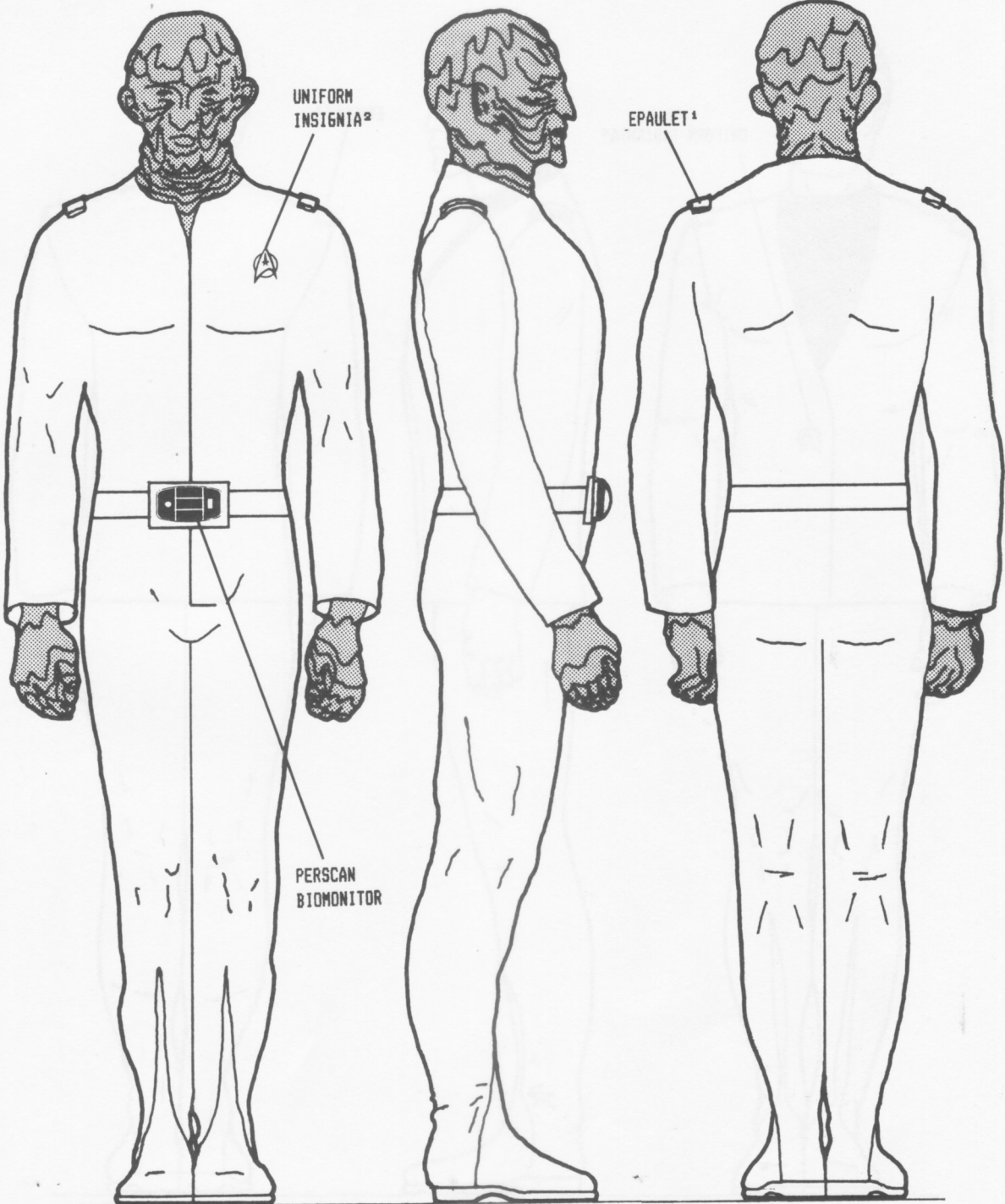

 FSC 482 BEIGE

¹SEE TO:01:03:05:20.01

²SEE TO:01:03:05:10.03 AND TO:01:03:05:20.01

RS: 480371.6

TO:01:03:05:04.03



CLASS D WORKSUIT

STAR FLEET-UNISEX ALL RANKS & RATINGS (TYPE FOUR-SHORE INSTALLATIONS)

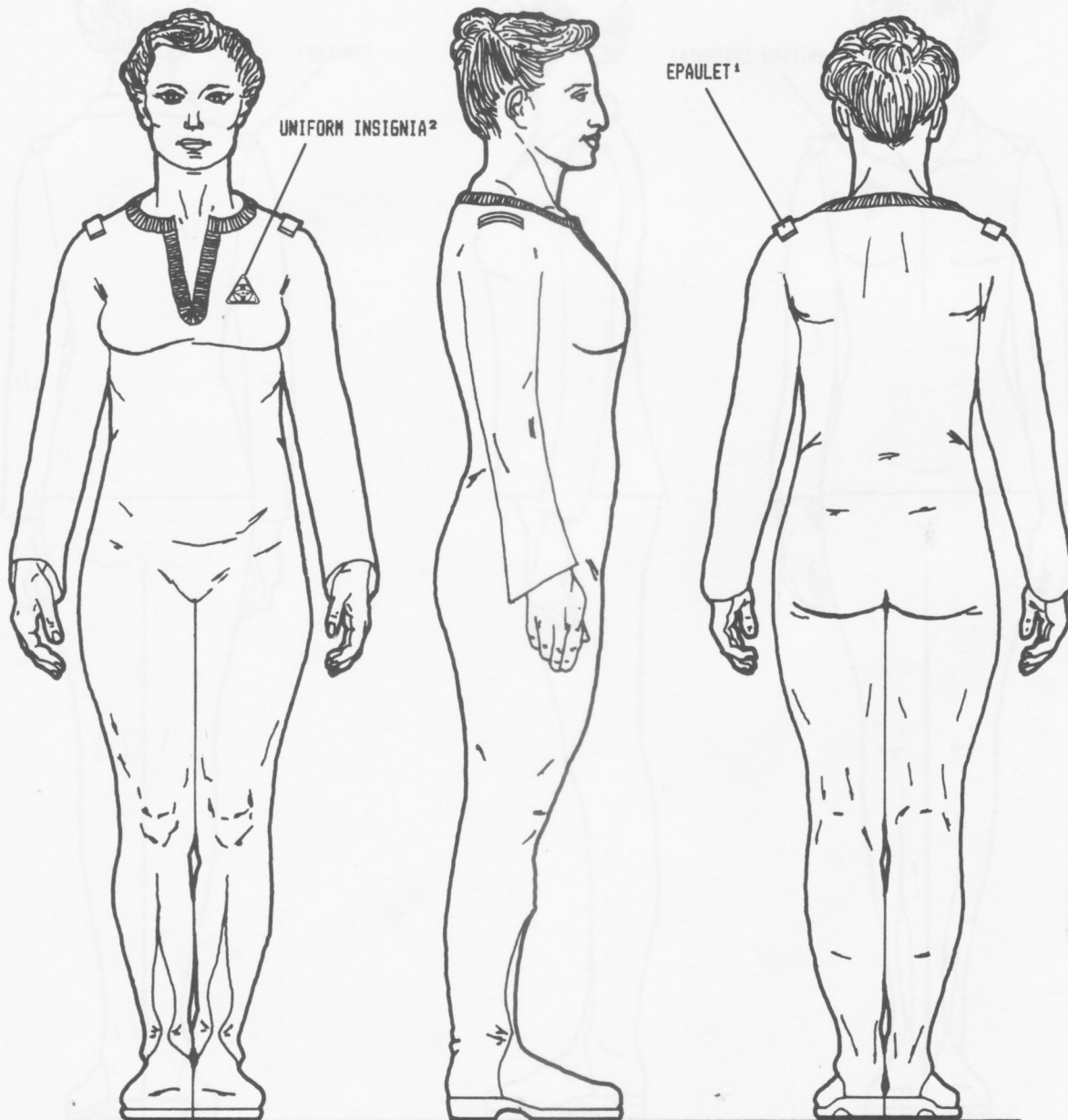

WORKSUIT COLOR: NON-COMMISSIONED RATINGS - FSC 448 BROWN
 JUNIOR OFFICERS' RANKS - FSC 128 BEIGE
 SENIOR OFFICERS' RANKS - FSC 297 PALE BLUE GRAY

¹SEE TO:01:03:05:20.01

²SEE TO:01:03:05:10.03 AND TO:01:03:05:20.01

RS: 480371.6

TO:01:03:05:04.04



CLASS D WORKSUIT

STAR FLEET MEDICAL CORPS-UNISEX ALL RANKS & RATINGS (TYPE FIVE)

RS: 480371.6

TO:01:03:05:04.05

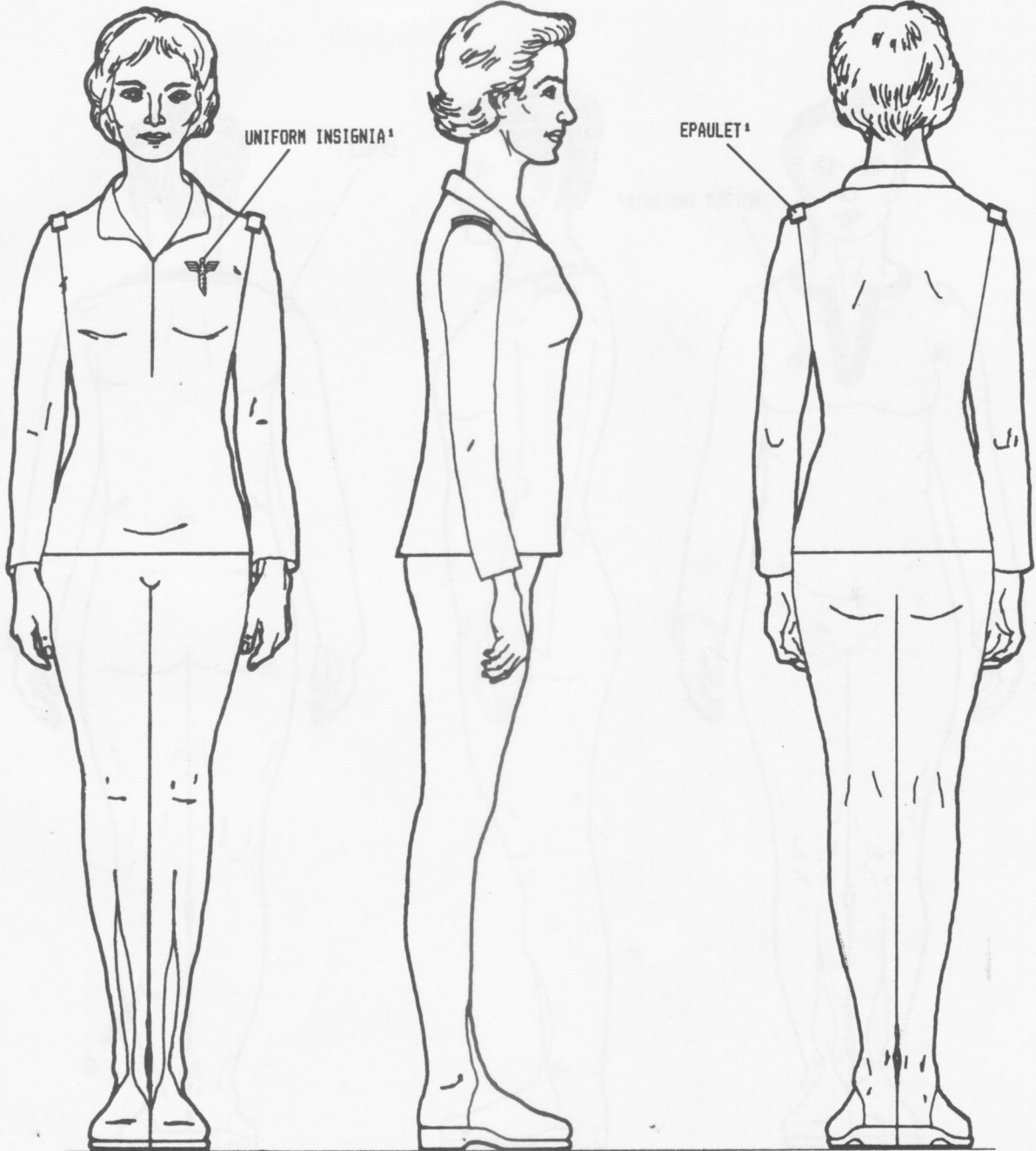

 FSC 001 WHITE

*SEE TO:01:03:05:20.01

NOTE: BY ADMINISTRATIVE ORDER 01:03:05:00.74, THIS UNIFORM IS AVAILABLE IN STANDARD WORKSUIT COLORS (SEE TO:01:03:05:04.01) FOR USE AS A WORKSUIT BY ALL STAR FLEET PERSONNEL.

AMENDMENT CODE:REV02

AUTHENTICATED STARDATE 7912.07



FEDERATION STARSHIP

CLASS ONE MK V/03 BACKGROUND & CLASS LISTING

BACKGROUND OF KNOX CLASS:

SINCE THE POST-WAR YEARS OF THE 2250'S, STAR FLEET HAS MAINTAINED A CONSIDERABLE FORCE OF FRIGATES AS AN AFFORDABLE MEANS OF PATROLLING VAST SECTIONS OF PREVIOUSLY-UNGUARDED FEDERATION BORDERSPACE. STARSHIPS FROM BOTH THE SURYA AND COVENTRY CLASSES FILLED THIS ROLE ADMIRABLY FOR SOME TIME. IN RESPONSE TO LESSONS LEARNED DURING THE KZNTI INCURSION OF 2272, HOWEVER, MANY OF THE SURYA CLASS FRIGATES WERE HURRIEDLY UPGRATED TO AVENGER CLASS HEAVY FRIGATE SPECIFICATIONS. AS SOON THEREAFTER AS APPROPRIATIONS PERMITTED, THE CONVERTED FRIGATES WERE REPLACED BY STARSHIPS OF THE KNOX DESIGN.

TWO CONSIDERATIONS GUIDED THE DESIGN AND CONSTRUCTION OF THESE SPACECRAFT. FIRST, THE CONFIGURATION OF THE AVENGER CLASS HAD PROVEN SO IMPRESSIVE, BOTH IN TERMS OF WARP DYNAMICS AND DILITHIUM ENDURANCE, THAT THE DESIGN BOARD DETERMINED THAT THE NEW FRIGATE SHOULD BE A SCALED-DOWN VERSION OF THE HEAVY FRIGATE DESIGN. MISSING WOULD BE THE PHOTON WEAPONS PACKAGE AND THE LARGE HANGER BAYS AND FLIGHT DECKS USED FOR FIGHTERCRAFT OPERATIONS. IN OTHER RESPECTS, HOWEVER, THE OVERALL CONFIGURATION, WARP GEOMETRY, AND OFFENSIVE POTENTIAL WOULD BE QUITE SIMILAR.

A SECOND CONSIDERATION AFFECTING THE CONSTRUCTION HISTORY OF THE FRIGATES WAS THE DECISION TO HAVE ONE CONTRACTOR BUILD ALL 26 SPACECRAFT. PRESSED BY RENEWED INSTANCES OF KLINGON BORDER VIOLATIONS, STAR FLEET WAS ANXIOUS TO INCREASE THE SIZE OF ITS FRIGATE FLEET AS SOON AS POSSIBLE. TO ORDER A LARGE NUMBER OF SHIPS OVER A SHORT TIME SPAN, HOWEVER, WOULD REQUIRE THE ALLOCATION OF AN EXTRAORDINARY PORTION OF THE STARSHIP PROCUREMENT BUDGET-- UNLESS SOME MEANS WERE FOUND TO SIMULTANEOUSLY CUT PRODUCTION TIME AND COSTS. THIS GOAL WAS ACHIEVED BY PLACING THE ENTIRE ORDER WITH NEWPORT NEWS SHIPBUILDING, WHO COMPLETED THE PROJECT WITHIN FIVE EARTH YEARS AT TWELVE PERCENT UNDER BUDGET BY ELIMINATING MUCH ADMINISTRATIVE REDUNDANCY.

THE LEAD SHIP OF THE RESULTING CLASS WAS NAMED AFTER MATTHEW TURNBULL KNOX, A FORMER GOVERNOR OF THE MARTIAN COLONIES WHO FIGURED PROMINENTLY IN THAT PLANET'S MOVEMENT TO DECLARE INDEPENDENCE FROM THE BRITISH "THREE WORLD EMPIRE" EARLY IN THE TWENTY-SECOND CENTURY. HE WAS ALSO ONE OF THE AUTHORS OF THE "FUNDAMENTAL DECLARATIONS", WHICH GAVE FORM TO HUMANKIND'S FIRST GOVERNMENT INDEPENDENT OF TERRAN CONTROL. IT SHOULD BE NOTED THAT COMMANDER ARTEMUS BESTIMER, A DESCENDANT OF KNOX, WAS AWARDED FIRST COMMAND OF THE FRIGATE BEARING HIS ILLUSTRIOUS ANCESTOR'S NAME. ON SD 7904.36, BESTIMER GUIDED KNOX TO A POSITION IN FEDERATION-KLINGON BORDERSPACE WHERE CONSIDERABLE DATA COULD BE OBTAINED ON THE NEW K'TEREMNY DESTROYER DESIGN. LATER, KNOX AGAIN CONFRONTED ONE OF THESE DESTROYERS, AND IN ACTION INFLICTED CONSIDERABLE DAMAGE TO THE WARSHIP. FOR THESE ACTS, BESTIMER RECEIVED THE PRENTARIES RIBBON OF COMMENDATION (SECOND CLASS), AND THE STARSHIP WAS AWARDED A STAR FLEET CITATION.

CLASS LISTING OF KNOX CLASS:

NAME	NCC NUMBER	COMMISSIONED	STATUS	NAME	NCC NUMBER	COMMISSIONED	STATUS
KNOX	1940	17 MAY 2277	A2N	ABILITY	1953	09 JULY 2280	A3S
BIR HAKEIM	1941	01 JULY 2277	A3S	PICO	1954	18 NOV 2279	A0
SENESCHAL	1942	SD 6715.62	A3N	INCHARRON	1955	SD 7018.40	A1N
ENHANCE	1943	11 JAN 2278	A0	DILIGENCE	1956	08 MAY 2281	A3N
ASTURIAS	1944	27 FEB 2278	A1S	ATREVIDA	1957	11 MAR 2280	A4N
KIRI	1945	SD 6823.54	ATAC	SWIFT	1958	03 AUG 2280	A3N
OPPORTUNE	1946	06 SEPT 2278	A4N	PELELIU	1959	SD 7116.17	A4S
SIVRIHISAR	1947	19 FEB 2279	A3S	MATAPAN	1960	23 APR 2282	A2S
LE MALIN	1948	01 NOV 2278	A2S	ESPADON	1961	09 MAY 2283	A0
THACH	1949	SD 6854.27	A2S	SKATE	1962	SD 7200.50	A2N
SPRINGEREN	1950	12 JUNE 2279	A1N	MIRAMICHI	1963	04 FEB 2281	A3S
CASSIOPEE	1951	SD 6915.83	A2N	UTSIRA	1964	27 JUNE 2281	A3N
KAYA	1952	15 JUNE 2279	ATAC	CARRON	1965	01 DEC 2282	A3S

RS: 480371.4

TO: 01:04:01:05.21

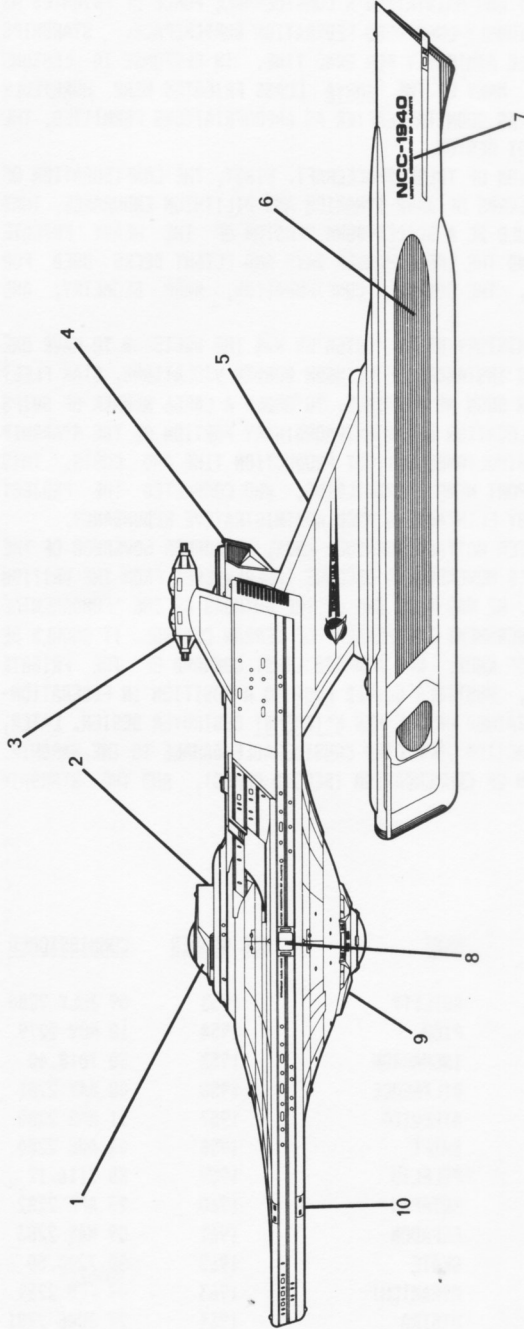

SUBFILE TWO: OUTBOARD PROFILE

RS: 480371-4

TD: 01:04:01:05.22

SPECIFICS:

- 1. BRIDGE
- 2. DOCKING PORT-BRIDGE
- 3. MEGAPHASER (4) - 2 EACH P/S
- 4. IMPULSE PROPULSION HOUSING
- 5. MACELLE SUPPORT PYLON
- 6. OUTBOARD FLUX CHILLER
- 7. NUMERICAL I.D. REGISTRY
- 8. MAIN GANGWAY HATCH
- 9. MAIN SENSOR ARRAY
- 10. REACTION CONTROL THRUSTER

UNITED FEDERATION OF PLANETS
STAR FLEET DIVISION
 BUREAU OF OPERATIONS - OFFICE OF RECORDS

GENERAL PLANS
 SPACECRAFT CLASS: CLASS ONE STARSHIP OF THE LINE
 MODEL: MK-V/03
 TYPE: FRIGATE
 NOMINAL CLASS: KNOX

GENERATED BY: MASTERCOM SFHQ
 SCALE: 1:1366





STAR FLEET REFERENCE REPORT

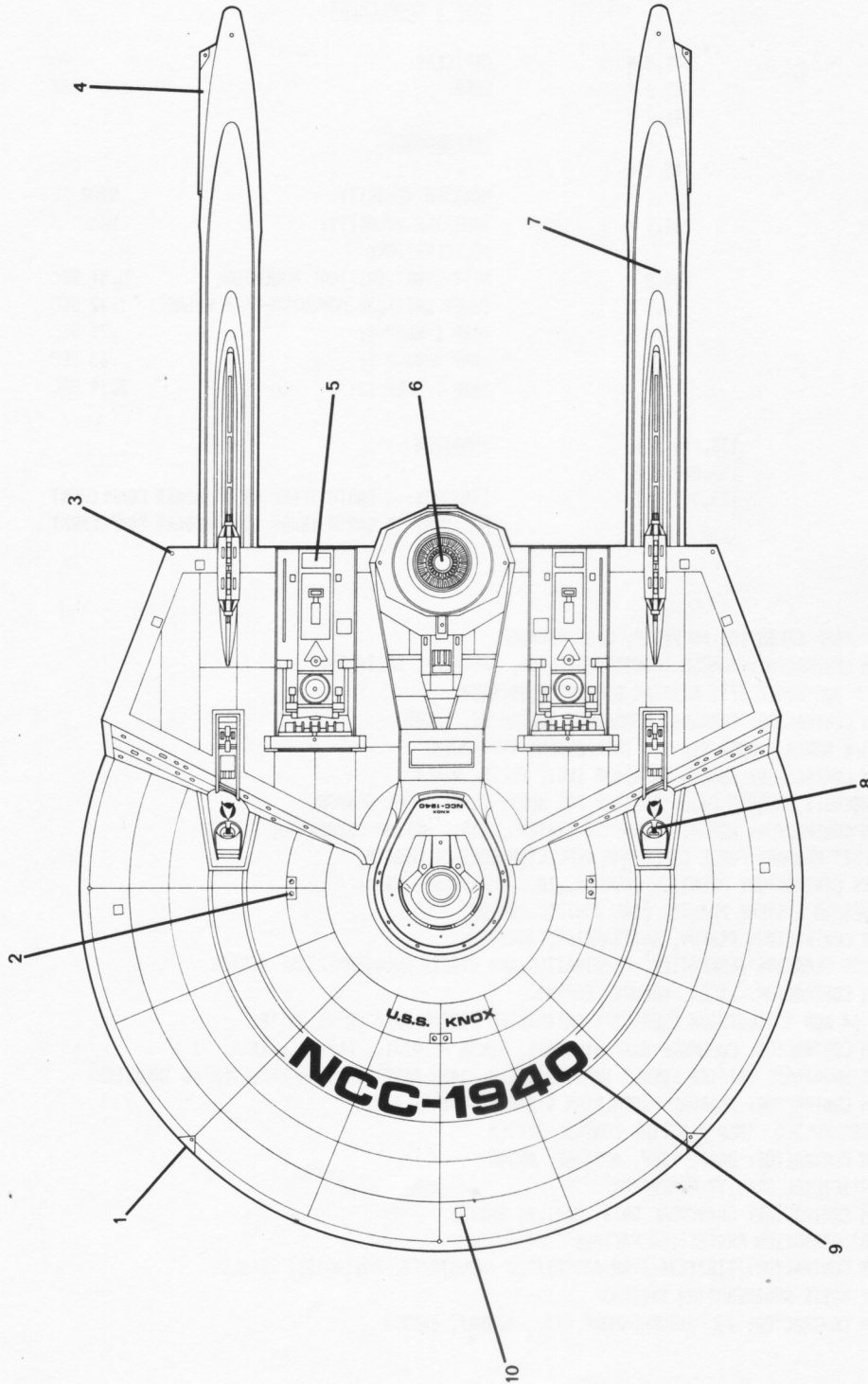

SUBFILE THREE: OUTBOARD TOP VIEW

RS:480371-4

TO:01:04:01:05.23
SPECIFICS:

1. REACTION CONTROL THRUSTER	6. IMPULSE DEFLECTION CRYSTAL
2. TOPSIDE PHASER THRUST (6)	7. WARP PROPULSION WACELLE-P/S
3. FORMATION LIGHT-P/S	8. SPACE ENERGY FIELD SENSOR-P/S
4. INTERCOOLER	9. NOMINAL & NUMERICAL I.D.
5. FLIGHT DECK VENTING SYSTEM	10. AIRLOCK LIFT HATCH (7)

UNITED FEDERATION OF PLANETS
STAR FLEET DIVISION
BUREAU OF OPERATIONS - OFFICE OF RECORDS

GENERAL PLANS		SPACECRAFT CLASS: CLASS ONE STARSHIP OF THE LINE
MODEL: MK-V/03	TYPE: FRIGATE	NOMINAL CLASS: KNOX
GENERATED BY: MASTERCOM SFHQ		SCALE: 1:1366





FEDERATION STARSHIP

CLASS ONE MK V/03 SPECIFICATIONS

CURRENT SPECIFICATIONS OF KNOX CLASS:

DIMENSIONS

OVERALL LENGTH: 243.3 M
 OVERALL DRAUGHT: 52.8 M
 OVERALL BEAM: 141.7 M

PRIMARY HULL LENGTH: 145.5 M
 PRIMARY HULL DRAUGHT: 32.9 M
 PRIMARY HULL BEAM: 141.7 M

NACELLE LENGTH: 154.8 M
 NACELLE DRAUGHT: 18.3 M
 NACELLE BEAM: 12.6 M

DISPLACEMENT

LIGHT: 133,000 M.T.
 STANDARD: 136,000 M.T.
 FULL LOAD: 139,000 M.T.

SHIP'S COMPLEMENT

OFFICERS: 90
 CREW: 260

PERFORMANCE

MAXIMUM VELOCITY: WARP 11
 CRUISING VELOCITY: WARP 7
 ACCELERATION:
 REST-ONSET CRITICAL MOMENTUM: 5.51 SEC
 ONSET CRITICAL MOMENTUM-WARP ENGAGE: 1.12 SEC
 WARP 1-WARP 4: .73 SEC
 WARP 4-WARP 7: .63 SEC
 WARP 7-WARP 11: 2.19 SEC

DURATION

STANDARD: 5 EARTH YEARS AT STANDARD COMPLEMENT
 MAXIMUM: 19 EARTH YEARS AT STANDARD COMPLEMENT

SYSTEMS

NAVIGATION: "ARTOS" WARP CELESTIAL GUIDANCE, L.D. PACKAGE
 (SYSTEM CONTRACTOR: MANDOR INDUSTRIES, LTD., DALHALAM, DELTA IV)

COMPUTERS: "FASFAX" DUOTRONIC III; DATATAC SUPPORT SUBSYSTEM
 (SYSTEM CONTRACTOR: FARRANTI NEMONICS, BERKSHIRE, EARTH)

WEAPONS: PHASERS: 6 BANKS/2 EACH RIM-10C INDEPENDENT TWIN MOUNT
 (SYSTEM CONTRACTOR: AGUSTA ANSADADO INC., FUZES, VENUS)
 MEGAPHASERS: 2 BANKS/2 EACH "EMPEROR 60" MULTI-DIRECTIONAL CANNON
 (SYSTEM CONTRACTOR: ASAKAZE ORDNANCE SYSTEMS, LTD., HONSHU-HAMAMATSU, EARTH)

DEFENSE: "LANCELOT" PRIMARY FORCE FIELD AND DEFLECTOR CONTROL SYSTEM
 (SYSTEMS CONTRACTOR: PRENTICE-SCHAFFER, INC., MARSPOUR, MARS)
 DOBIS WEAPON SYSTEM; PRA-TAK FIRE CONTROL ADD-ON
 (SYSTEM CONTRACTOR: RAAKUV, GAZIWAHAIDA, ANDOR)
 C6CP/SCDS CLOAKING GENERATION, PENETRATION AND STASIS COUNTERMEASURE SYSTEM
 (SYSTEM CONTRACTOR: HYCOR, WOBURN, EARTH)

PROPULSION: (2) LN-64 MOD 4 DILITHIUM ENERGIZED ANTIMATTER LINEAR WARP DRIVE UNITS
 (SYSTEM CONTRACTOR: COCHRANE WARP DYNAMICS, MINOS AL RIJIL, ALPHA CENTAURI VII)
 (2) RST SUBATOMIC UNIFIED ENERGY IMPULSE UNITS; QASR PARTICLE BEAM MANUEVERING THRUSTERS
 (SYSTEM CONTRACTOR: SCARBAK PROPULSION SYSTEMS, CAIRO, EARTH)
 "TRENTIS" PULSED LASER REACTION CONTROL SYSTEM
 (SYSTEM CONTRACTOR: ORAGE IJEK, AKSAJAK, ANDOR)

LIFE SUPPORT: MB-5 ARTIFICIAL GRAVITY GENERATOR
 (SYSTEM CONTRACTOR: CRISTOBAL SM/S, MANILA, EARTH)
 "RASTIS" RADIATION PROTECTION PACKAGE
 (SYSTEM CONTRACTOR: TIDJIKJA/ATAR ASSOCIATED INDUSTRIES, RASTARIBI, REGULUS)
 "CERIX" WASTE REGENERATION SYSTEMS
 (SYSTEM CONTRACTOR: JULLUNDUR-LAHORE LTD., BOMBAY, EARTH)

RS: 480371.4

TO: 01:04:01:05.29



FEDERATION STARSHIP

CLASS ONE MK VI/01 BACKGROUND & CLASS LISTING

BACKGROUND OF PTOLEMY CLASS:

AFTER SHAKEDOWN TRIALS WERE COMPLETED ON THE HEAVY CRUISER CONSTITUTION IN 2217, IT WAS DETERMINED THAT, FOR THE SAKE OF EFFICIENCY, THE TYPE OF MODULAR COMPONENTS DEVELOPED FOR THIS DESIGN COULD AND SHOULD BE RECOMBINED TO SERVE OTHER PURPOSES. ARISING FROM THIS DECISION HAVE COME MANY STARSHIP DESIGNS, THE FIRST OF WHICH WAS THE PTOLEMY TRANSPORT CONFIGURATION SUBMITTED ONLY MONTHS AFTER THE COMMISSIONING OF CONSTITUTION. AS ORIGINALLY CONSTRUCTED, PTOLEMY AND HER SISTERS WERE UNARMED AND, BECAUSE OF THE LIMITED FIELD GENERATION CAPABILITY OF THE OLD PB-18 WARP DRIVE UNITS, COULD ONLY CARRY ONE OF THE SPECIALLY DESIGNED CLASS ONE CONTAINERS AT A TIME.

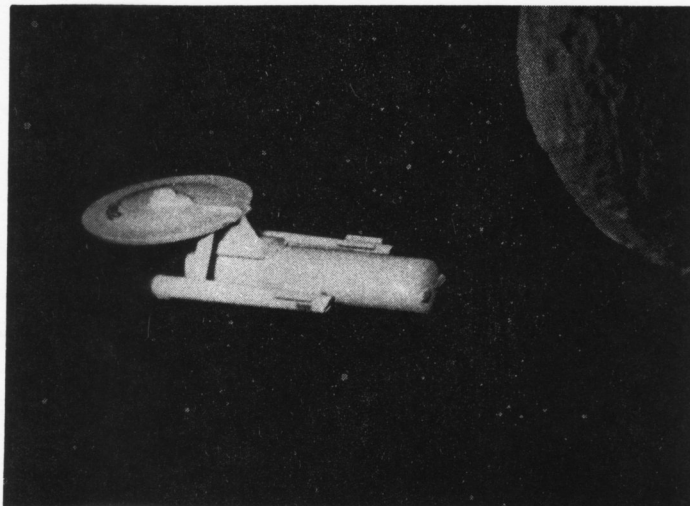

U.S.S. PYTHAGORAS (NCC-3812) APPROACHING JANUS VI

IN 2255 A REVIEW BOARD WAS ESTABLISHED TO DETERMINE WHETHER IT WOULD BE MORE COST EFFECTIVE TO UPRATE THE PTOLEMY CLASS OR TO CONSTRUCT TRANSPORTS OF THE RECENTLY SUBMITTED KEPPLER CONFIGURATION. THE EXPERIENCE OF THE RECENT FOUR YEARS WAR (2246-50) HAD TAUGHT STAR FLEET THE DANGERS OF BEING CAUGHT WITHOUT ADEQUATE TRANSPORTS, AS WHOLE COLONIES AND SUPPLY BASES ALONG EMBATTLED SPACE LANES PERISHED BECAUSE THE OVERWORKED AND UNARMED PTOLEMY'S COULD NOT GET THROUGH. AFTER CAREFUL ANALYSIS IT WAS DECIDED THAT BOTH OPTIONS SHOULD BE PURSUED. AND SO, NOT ONLY WAS CONSTRUCTION OF FIFTEEN KEPPLER CLASS TRANSPORTS AUTHORIZED, BUT THE MODERNIZATION OF THE PTOLEMY CLASS WAS ALSO APPROVED. AS A RESULT, THE PTOLEMY TRANSPORTS WERE REFITTED WITH PB-32 WARP DRIVE UNITS, GIVING THEM THE EXTENDED FIELD CAPABILITY NECESSARY TO CARRY TWO CONTAINERS AT A TIME. THE ADDITIONAL POWER AVAILABLE FROM THE MORE EFFICIENT WARP DRIVE UNITS ALSO ALLOWED PHASER BANKS TO BE INSTALLED.

THE THREAT OF WAR WITH THE KLINGON EMPIRE IN THE EARLY 2260'S LED TO THE DEVELOPMENT OF THE PB-47 SERIES WARP DRIVE FOR THE ACHERNAR CLASS HEAVY CRUISER, AND STARSHIPS OF THE PTOLEMY CLASS WERE UPRATED TO REFLECT THIS ADVANCE. AND YET, DESPITE MODERNIZATION, THE BURDEN OF AGE IS BEGINNING TO SHOW ON THESE SHIPS (THE OLDEST OF WHICH IS APPROACHING 65 TERRAN YEARS SINCE COMMISSIONING), AND FREQUENT OVERHAULS HAVE BECOME NECESSARY. IT WAS THUS ORDERED ON 06 MAR 2288 BY THE DEPUTY CHIEF OF STAR FLEET OPERATIONS THAT STARSHIPS OF THIS CLASS BE DECOMMISSIONED ON AN INDIVIDUAL BASIS AS TRANSPORTS OF THE DOPPLER AND DOLLOND CLASSES ACHIEVE OPERATIONAL READINESS. AS OF THIS TIME HOWEVER, ONLY AL RASHID (NCC-3802) HAS BEEN DECOMMISSIONED.

CLASS LISTING OF PTOLEMY CLASS:

NAME	NCC NUMBER	COMMISSIONED	STATUS	NAME	NCC NUMBER	COMMISSIONED	STATUS
<u>PTOLEMY</u>	3801	30 APR 2224	ATC2N	<u>HIPPARCHOS</u>	3809	SD 2902.46	ATC3S
<u>AL RASHID</u>	3802	07 DEC 2227	DC	<u>ULUGH BEG</u>	3810	28 APR 2229	ATC2S
<u>ANAXAGORAS</u>	3803	14 MAY 2228	ATC4S	<u>PHILOLAUS</u>	3811	07 AUG 2229	ATC4N
<u>ANAXIMANDER</u>	3804	10 JUN 2228	RDF	<u>PYTHAGORAS</u>	3812	06 JAN 2230	ATC1N
<u>ARISTARCHUS</u>	3805	07 NOV 2228S	ATC3N	<u>THALES</u>	3813	21 MAR 2230	SRO
<u>IBN DAUD</u>	3806	SD 2812.14	SR3S	<u>HEVELIUS</u>	3814	10 APR 2230	RTC2S
<u>ERATOSTHENES</u>	3807	22 JAN 2229	ATC1S	<u>COPERNICUS</u>	3815	SD 3005.20	ATCO
<u>GALILEI</u>	3808	23 JAN 2229	SR3N				

RS: 480371.1

TO: 01:04:01:06:01

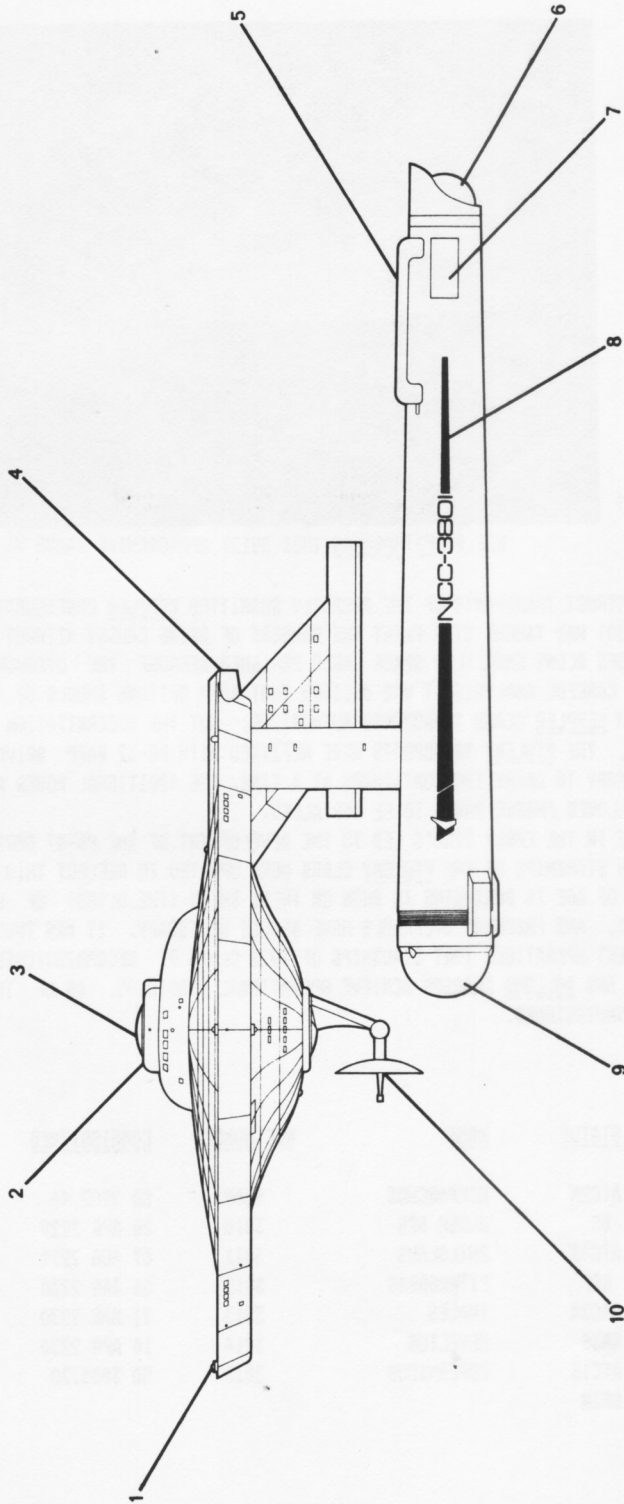

SUBFILE TWO: OUTBOARD PROFILE
 RS: 480371-1
 TO: 01:04:01:06.02
 SPECIFICS:
 1. BOW LIGHT
 2. BRIDGE
 3. SPACE SENSOR ARRAY-T/8
 4. IMPULSE PROPULSION HOUSING
 5. INTERCOOLERS-P/S PER UNIT
 6. SPACE WARP GENERATOR
 7. FINAL MAGNETOMIC FLUX CHILLER
 8. STAR FLEET I.D. PENNANT
 9. MATTER INTAKE
 10. MAIN SENSOR & NAV. DEFLECTOR

UNITED FEDERATION OF PLANETS
 STAR FLEET DIVISION
 BUREAU OF OPERATIONS - OFFICE OF RECORDS

GENERAL PLANS
 SPACECRAFT CLASS:
 CLASS ONE STARSHIP OF THE LINE
 MODEL: HK-VI/01
 TYPE: TRANSPORT/TUG
 NOMINAL CLASS:
 PTOLEMY
 GENERATED BY:
 MASTERCAM SFHQ
 SCALE: 1:1366





STAR FLEET REFERENCE REPORT

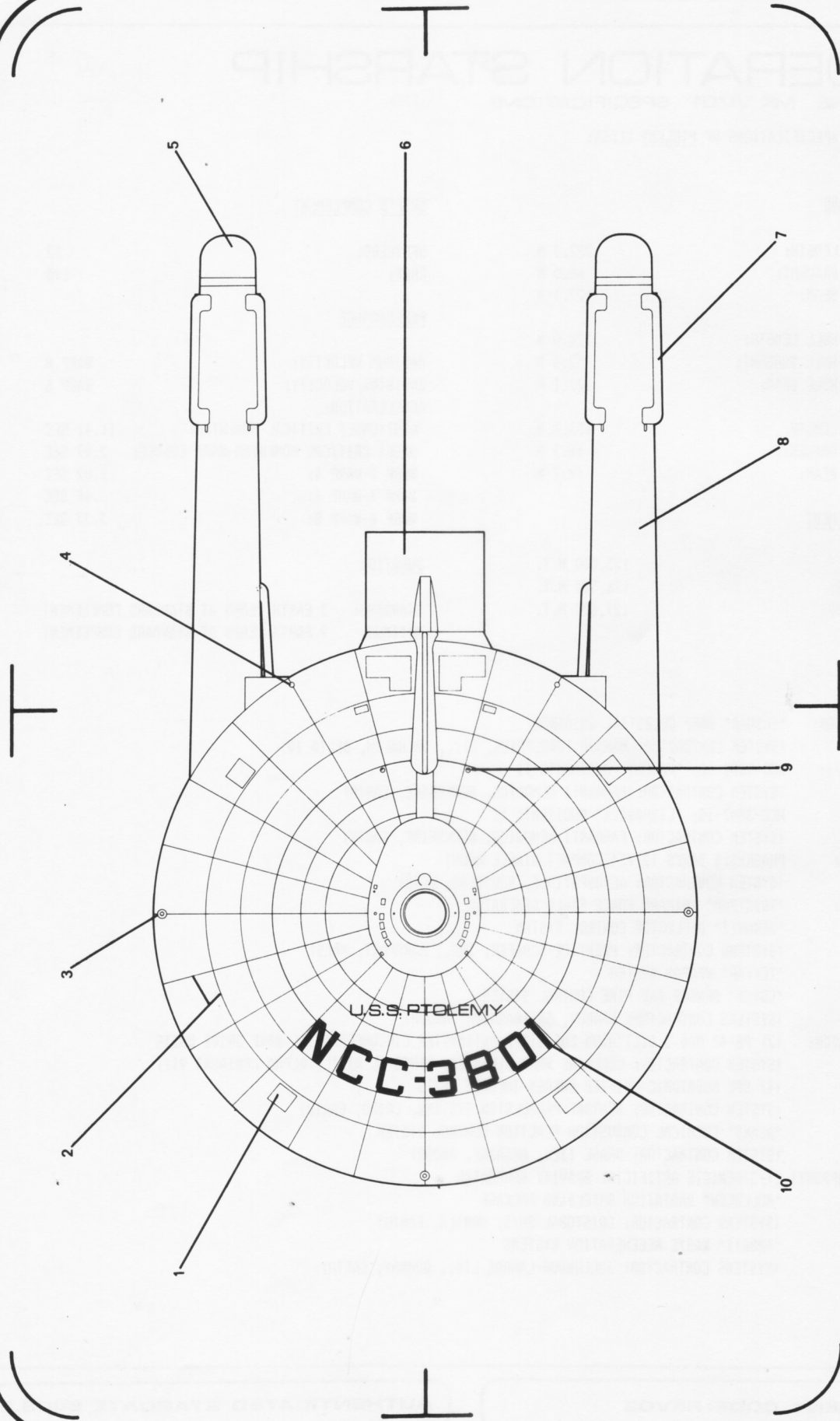

SUBFILE THREE: OUTBOARD TOP VIEW
 RS:480371-1
 TO:01:04:01:06.03
 SPECIFICS:
 1. AIRLOCK LIFT HATCH (4)
 2. DEFLECTOR GRID
 3. RUNNING LIGHT-T/8; P/S
 4. FORMATION LIGHT-P/S
 5. GENERATOR COMB
 6. TOW PAD
 7. INTERCOOLERS-P/S PER UNIT
 8. WARP PROPULSION NAELLE-P/S
 9. TOPSIDE PHASER TURRET-P/S
 10. NOMINAL & NUMERICAL I.D.

UNITED FEDERATION OF PLANETS STAR FLEET DIVISION BUREAU OF OPERATIONS - OFFICE OF RECORDS	
GENERAL PLANS	SPACECRAFT CLASS: CLASS ONE STARSHIP OF THE LINE
MODEL: MK-VI/01	TYPE: TRANSPORT/TUG
GENERATED BY: MASTERCOM SFHQ	NOMINAL CLASS: PTOLEMY
	SCALE: 1:1366





FEDERATION STARSHIP

CLASS ONE MK VI/01 SPECIFICATIONS

CURRENT SPECIFICATIONS OF PTOLEMY CLASS:

DIMENSIONS

OVERALL LENGTH: 222.0 M
 OVERALL DRAUGHT: 66.0 M
 OVERALL BEAM: 127.1 M

PRIMARY HULL LENGTH: 128.0 M
 PRIMARY HULL DRAUGHT: 52.0 M
 PRIMARY HULL BEAM: 127.1 M

NACELLE LENGTH: 153.6 M
 NACELLE DRAUGHT: 18.2 M
 NACELLE BEAM: 19.7 M

DISPLACEMENT

LIGHT: 125,000 M.T.
 STANDARD: 126,500 M.T.
 FULL LOAD: 127,000 M.T.

SYSTEMS

NAVIGATION: "SASMA" WARP CELESTIAL GUIDANCE
 (SYSTEM CONTRACTOR: MANDOR INDUSTRIES, LTD., DALHALAM, DELTA IV)

COMPUTERS: NCC-3801-06: "FASFAX" DUOTRONIC II
 (SYSTEM CONTRACTOR: FARRANTI NEMONICS, BERKSHIRE, EARTH)
 NCC-3807-15: "LIBRASEEK" DUOTRONIC II
 (SYSTEM CONTRACTOR: FARRANTI NEMONICS, BERKSHIRE, EARTH)

WEAPONS: PHASERS: 4 BANKS 127/54 COMPACT SINGLE MOUNT
 (SYSTEM CONTRACTOR: AEROSPATIALE, ROUSSEAU, MARS)

DEFENSE: "TRISTRAM" PRIMARY FORCE FIELD GENERATOR
 "JENGHIZ" DEFLECTOR CONTROL SYSTEM
 (SYSTEMS CONTRACTOR: PRENTICE-SCHAFFER, INC., MARSPOET, MARS)
 "TEKTAR" WEAPON SYSTEM

PROPULSION: "CONUS" SENSOR AND FIRE CONTROL SYSTEM
 (SYSTEMS CONTRACTOR: RAAKUV, GAZIWAHAIDA, ANDOR)
 (2) PB-47 MOD 3 DILITHIUM ENERGIZED ANTIMATTER CIRCUMFERENTIAL WARP DRIVE UNITS
 (SYSTEM CONTRACTOR: COCHRANE WARP DYNAMICS, MINOS AL RIJIL, ALPHA CENTAURI VII)
 (4) SBE SUBATOMIC UNIFIED ENERGY IMPULSE UNITS
 (SYSTEM CONTRACTOR: SCARBAK PROPULSION SYSTEMS, CAIRO, EARTH)
 "ASAKS" CHEMICAL COMBUSTION REACTION CONTROL SYSTEM
 (SYSTEM CONTRACTOR: DRAGE IJEK, AKSAJAK, ANDOR)

LIFE SUPPORT: CT-3/CENTRIS ARTIFICIAL GRAVITY GENERATOR
 "MOLLUKEN" RADIATION SHIELDING PACKAGE
 (SYSTEMS CONTRACTOR: CRISTOBAL SM/S, MANILA, EARTH)
 "AMBRIX" WASTE REGENERATION SYSTEMS
 (SYSTEMS CONTRACTOR: JULLUNDUR-LAHORE LTD., BOMBAY, EARTH)

SHIP'S COMPLEMENT

OFFICERS: 22
 CREW: 198

PERFORMANCE

MAXIMUM VELOCITY: WARP 8
 CRUISING VELOCITY: WARP 6
 ACCELERATION:
 REST-ONSET CRITICAL MOMENTUM: 11.41 SEC
 ONSET CRITICAL MOMENTUM-WARP ENGAGE: 2.07 SEC
 WARP 1-WARP 4: 1.02 SEC
 WARP 4-WARP 6: .68 SEC
 WARP 6-WARP 8: 3.37 SEC

DURATION

STANDARD: 3 EARTH YEARS AT STANDARD COMPLEMENT
 MAXIMUM: 9 EARTH YEARS AT STANDARD COMPLEMENT

RS: 480371-1

TO: 01:04:01:06.09



FEDERATION STARSHIP

CLASS ONE MK.VIII/01 BACKGROUND & CLASS LISTING

BACKGROUND OF SALADIN CLASS:

IN 2219 SKORPIOS/KANARIS E.T.M. WAS CONTRACTED TO DEVELOP PLANS FOR BOTH DESTROYER AND SCOUT TYPE STARSHIPS. THE FIRM RESPONDED WITH A SINGLE DESIGN, UTILIZING COMPONENTS DEVELOPED FOR THE CONSTITUTION CLASS HEAVY CRUISER, WHICH CONSISTED OF A PRIMARY HULL ATTACHED BY DORSAL TO A SINGLE WARP DRIVE UNIT. IT WAS PROJECTED THAT THE NEW STARSHIPS WOULD DERIVE THEIR ADVANTAGES FROM THEIR LOW MASS AND OVERALL SMALL CONFIGURATION. LOW MASS WOULD PROVIDE THE ABILITY TO ACHIEVE CRITICAL MOMENTUM RAPIDLY AND THUS ALLOW HYPERSPACE ENTRY IN LESS TIME THAN ANY STARSHIP THEN EXISTING. THE SMALL CONFIGURATION WOULD MAKE A RELATIVELY SMALL WARP FIELD NECESSARY, THUS PROVIDING A LONG RATE OF DILITHIUM DECAY AND GREAT ENDURANCE.

AUTHORIZATION WAS GIVEN FOR TWENTY OF THE STARSHIPS OUTFITTED AS DESTROYERS AND SIXTEEN AS SCOUTS. WHILE THE FORTHCOMING SALADIN CLASS DESTROYERS PROVED SUCCESSFUL, THE HERMES CLASS SCOUTS WERE SOON MADE OBSOLETE BY FASTER, MORE VERSATILE DESIGNS. AND SO, DURING REGULAR OVERHAULS SHIPS OF THIS CLASS WERE UPGRADATED TO SALADIN CLASS DESTROYER SPECIFICATIONS. TODAY, THE SURVIVORS OF BOTH CLASSES CONTINUE TO SERVE IMPORTANT FUNCTIONS DESPITE THEIR AGE. PLANS CALL FOR THEIR MAINTENANCE FOR THE FORSEEABLE FUTURE.



U.S.S. SACAJAWEA (NCC-598) ON PATROL WEAR CESTUS IN OCT 2267

CLASS LISTING OF SALADIN CLASS:

NAME	NCC NUMBER	COMMISSIONED	STATUS	NAME	NCC NUMBER	COMMISSIONED	STATUS
SALADIN	500	28 MAR 2224	A1S	(UPGRATED HERMES CLASS SCOUTS)			
JENGHIZ	501	14 JAN 2226	D	HERMES	585	SD 2401.01	LD
DARIUS	502	SD 2602.28	A0	ANUBIS	586	03 JUN 2224	A3S
ALARIC	503	SD 2604.36	A2S	APOLLO	587	SD 2402.06	D
SARGON (EX NIKOLAI)	504	27 JAN 2226	A2S	AEOLUS	588	15 FEB 2225	RDF
XERXES	505	SD 2602.54	A3N	DIANA	589	04 APR 2225	RTC3N
POMPEY	506	31 JAN 2226	DC	QUINTILUS	590	21 JUN 2225	DC
KUBLAI	507	08 FEB 2226	SR3N	BRIDGER	591	SD 2507.52	L1
SULEIMAN	508	12 MAR 2226	A0	CARSON	592	SD 2510.47	SR3N
ETZEL	509	SD 2604.24	D	BATIDOR	593	17 AUG 2225	RDF
TAMERLANE	510	SD 2640.41	A2S	CODY	594	03 SEP 2225	A3S
ALEXANDER	511	SD 2649.31	SR2S	REVERE	595	12 OCT 2225	A3S
HANNIBAL	512	15 MAY 2226	A0	SPAKER	596	SD 2511.24	RTC3S
AHRIMAN	513	22 SEP 2226	A4S	BOWIE	597	10 DEC 2225	A1N
RAHMAN	514	SD 2610.44	A3N	SACAJAWEA	598	06 MAR 2226	A3S
ADAD	515	SD 2614.81	A4N	TONTI	599	SD 2604.12	SR3S
HASHISHIYUN	516	28 SEP 2226	A2N	CROCKETT	600	15 MAY 2226	RTC3N
AZRAEL	517	12 OCT 2226	RDF				
HAMILCAR	518	04 NOV 2226	RTC2S				
SHAITAN	519	21 DEC 2226	D				

RS: 480371.1

TO: 01:04:01:08.01

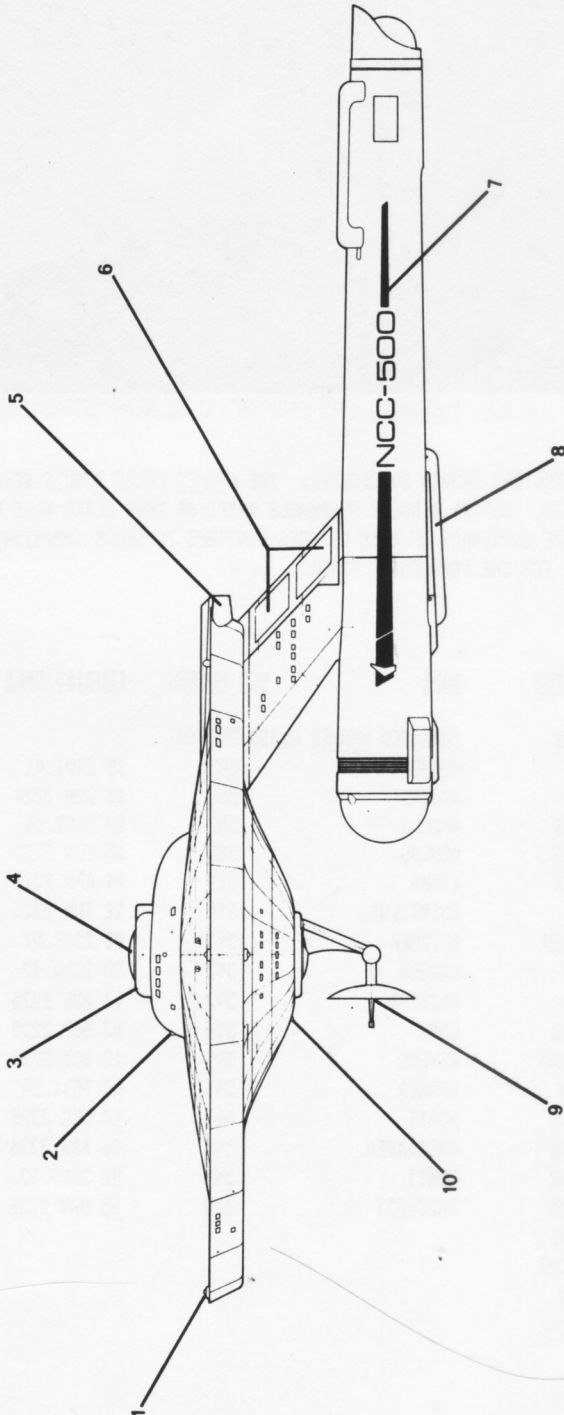

UNITED FEDERATION OF PLANETS
 STAR FLEET DIVISION
 BUREAU OF OPERATIONS - OFFICE OF RECORDS

GENERAL PLANS		SPACECRAFT CLASS: CLASS ONE STARSHIP OF THE LINE	
MODEL: MK-VIII/01	TYPE: DESTROYER	NOMINAL CLASS: SALADIN	
GENERATED BY: MASTERCOM SFHQ		SCALE:	1:1366

SUBFILE TWO: OUTBOARD PROFILE

- TD:01:04:01:08.02
 RS:480371-1
- SPECIFICS:**
1. BOW LIGHT
 2. PHOTON TORPEDO EJECTOR-P/S
 3. BRIDGE
 4. SPACE SENSOR ARRAY-T/B
 5. IMPULSE PROPULSION HOUSING
 6. EMERGENCY FLUSH VENTS-P/S
 7. STAR FLEET I.D. PENNANT
 8. CONTROL REACTOR LOOP
 9. MAIN SENSOR & NAV. REFLECTOR
 10. UNDERSIDE PHASER TURRET-P/S





STAR FLEET REFERENCE REPORT

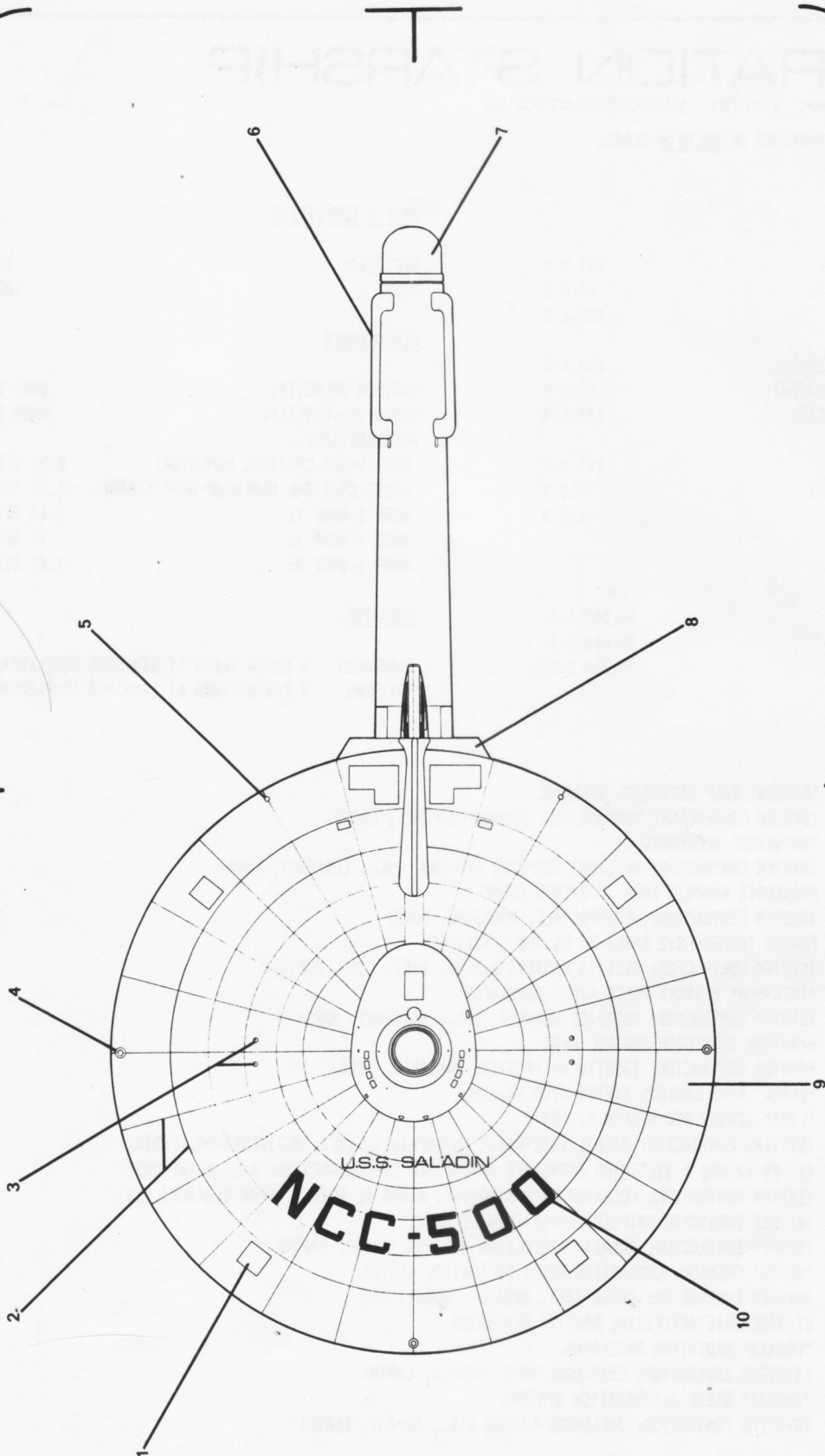

SUBFILE THREE: OUTBOARD TOP VIEW
 RS:480371-1
 TO:01:04:01:08.03
 SPECIFICS:
 1. AIRLOCK LIFT HATCH (4)
 2. DEFLECTOR GRID
 3. TOPSIDE PHASER TURRETS-P/S
 4. RUNNING LIGHT-T/B; P/S
 5. FORMATION LIGHT-P/S
 6. INTERCOOLERS-P/S
 7. GENERATOR COIL
 8. IMPULSE PROPULSION HOUSING
 9. PRIMARY HULL
 10. NOMINAL & NUMERICAL I.D.

UNITED FEDERATION OF PLANETS
 STAR FLEET DIVISION
 BUREAU OF OPERATIONS - OFFICE OF RECORDS

GENERAL PLANS	SPACECRAFT CLASS: CLASS ONE STARSHIP OF THE LINE
MODEL: NK-VIII/01	NOMINAL CLASS: SALADIN
GENERATED BY: MASTERCOM SFHG	TYPE: DESTROYER SCALE: 1:1366





FEDERATION STARSHIP

CLASS ONE MK VIII/01 SPECIFICATIONS

CURRENT SPECIFICATIONS OF SALADIN CLASS:

DIMENSIONS

OVERALL LENGTH: 242.5 M
 OVERALL DRAUGHT: 60.0 M
 OVERALL BEAM: 127.1 M

PRIMARY HULL LENGTH: 128.0 M
 PRIMARY HULL DRAUGHT: 52.0 M
 PRIMARY HULL BEAM: 127.1 M

NACELLE LENGTH: 153.6 M
 NACELLE DRAUGHT: 19.2 M
 NACELLE BEAM: 16.8 M

DISPLACEMENT

LIGHT: 94,500 M.T.
 STANDARD: 95,000 M.T.
 FULL LOAD: 95,500 M.T.

SYSTEMS

NAVIGATION: "GARGON" WARP CELESTIAL GUIDANCE
 (SYSTEM CONTRACTOR: THOMSON CSF, MEUDON-LA-FORET, EARTH)

COMPUTERS: "DAYSTROM" DUOTRONIC II
 (SYSTEM CONTRACTOR: DAYSTROM COMPUTER SYSTEMS, INC., LUNAPORT, LUNA)

WEAPONS: PHASERS: 3 BANKS/2 EACH 27/2 TWIN MOUNT
 (SYSTEM CONTRACTOR: AEROSPATIALE, ROUSSEAU, MARS)
 PHOTON TORPEDOES: 2 BANKS MK 16 MOD 1 INDIRECT
 (SYSTEM CONTRACTOR: SELENIA SISTEMI S.P.A., INC., ROME, EARTH)

DEFENSE: "TRISTRAM" PRIMARY FORCE FIELD GENERATOR
 (SYSTEM CONTRACTOR: PRENTICE-SCHAFFER, INC., MARSPOET, MARS)
 6/AS/RAM DEFLECTOR CONTROL UNIT
 (SYSTEM CONTRACTOR: TRESTIS AR TRESTIS, PANGAEAR, IZAR)
 "SABER" FIRE CONTROL SYSTEM WITH TRI-TEL
 "LYNX" SENSOR AND WEAPON SYSTEM
 (SYSTEMS CONTRACTOR: SIGNAL ELECTRONIC ENTERPRISES, INC., MEDITERRANEA, EARTH)

PROPULSION: (1) PB-47 MOD 1 DILITHIUM ENERGIZED ANTIMATTER CIRCUMFERENTIAL WARP DRIVE UNIT
 (SYSTEM CONTRACTOR: COCHRANE WARP DYNAMICS, MINOS AL RIJIL, ALPHA CENTAURI VII)
 (4) SBE SUBATOMIC UNIFIED ENERGY IMPULSE UNITS
 (SYSTEM CONTRACTOR: SCARBAK PROPULSION SYSTEMS, CAIRO, EARTH)
 "ASAKS" CHEMICAL COMBUSTION REACTION CONTROL SYSTEM
 (SYSTEM CONTRACTOR: DRAGE IJEK, AKSAJAK, ANDOR)

LIFE SUPPORT: CT-3/CENTRIS ARTIFICIAL GRAVITY GENERATOR
 "CORAZA" RADIATION SHIELDING
 (SYSTEMS CONTRACTOR: CRISTOBAL SM/S, MANILA, EARTH)
 "AMBRIX" WASTE REGENERATION SYSTEMS
 (SYSTEMS CONTRACTOR: JULLUNDUR-LAHORE LTD., BOMBAY, EARTH)

SHIP'S COMPLEMENT

OFFICERS: 20
 CREW: 180

PERFORMANCE

MAXIMUM VELOCITY: WARP 8
 CRUISING VELOCITY: WARP 6
 ACCELERATION:
 REST-ONSET CRITICAL MOMENTUM: 8.56 SEC
 ONSET CRITICAL MOMENTUM-WARP ENGAGE: 3.32 SEC
 WARP 1-WARP 4: 2.13 SEC
 WARP 4-WARP 6: 1.47 SEC
 WARP 6-WARP 8: 7.01 SEC

DURATION

STANDARD: 3 EARTH YEARS AT STANDARD COMPLEMENT
 MAXIMUM: 9 EARTH YEARS AT STANDARD COMPLEMENT

RS: 480371.1

TO: 01:04:01:08:09

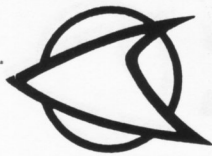

FEDERATION STARSHIP

CLASS ONE MK IX/03 . BACKGROUND & CLASS LISTING

BACKGROUND OF ACHERNAR CLASS:

THE CONSTITUTION CLASS OF HEAVY CRUISERS, WHEN DEVELOPED DURING THE SECOND DECADE OF THIS CENTURY, REPRESENTED A GREAT ADVANCE IN STARSHIP DESIGN. THE UTILIZATION OF MODULAR COMPONENTS ON A LARGE SCALE LED TO GREAT EFFICIENCY IN CONSTRUCTION AND LIFETIME MAINTENANCE. AS SUCH THESE STARSHIPS, AND THE DESIGN THEY SPANNED, HAVE PROVEN LONG LIVED.

CONSTITUTION AND HER SISTERS WERE ALL COMMISSIONED BEFORE 2225. THE SECOND GENERATION OF THE MK IX MODEL--THE QUITE SIMILAR BONHOMME RICHARD CLASS--WAS BUILT DURING AND AFTER THE FOUR YEARS WAR. SHORTLY

THEREAFTER MOST STARSHIPS OF THE CONSTITUTION CLASS WERE UPGRADED TO MATCH THE BONHOMME RICHARD SPECIFICATIONS. THE ACHERNAR CLASS, REPRESENTING THE THIRD GENERATION OF THIS MODEL, WAS DEVELOPED SOME TEN YEARS LATER AFTER IT BECAME APPARENT THAT STAR FLEET'S LACK OF EMPHASIS ON CAPITAL SHIP PROCUREMENT HAD INVITED KLINGON EXPANSION DESIGNS (LEADING TO THE ORGANIAN CONFLICT OF 2261). ORIGINALLY SIXTY EIGHT STARSHIPS OF THIS CLASS WERE TO BE BUILT, BUT AFTER SOME CONSIDERATION THAT NUMBER WAS CUT TO THIRTEEN, WITH PROVISIONS MADE FOR MODERNIZATION OF NINE CONSTITUTION AND SIXTEEN BONHOMME RICHARD CLASS STARSHIPS TO MATCH ACHERNAR'S SPECIFICATIONS.

ACHERNAR, THE FIRST OF THIS CLASS TO BE COMPLETED, WAS NAMED FOR A STAR SYSTEM, LOCATED IN THE ERIDANUS SECTOR, THAT WAS THE SITE OF A SIGNIFICANT BATTLE DURING THE EARTH-ROMULAN WAR A CENTURY EARLIER. THIS STARSHIP WAS THE FIRST TO BE FITTED WITH THE PB-47 CIRCUMFERENTIAL WARP DRIVE, AND DURING SECONDARY TRIALS ESTABLISHED RECORDS FOR HYPERSPACE ACCELERATION WHICH WERE NOT SURPASSED UNTIL THE DEVELOPMENT OF THE LINEAR WARP DRIVE SEVERAL YEARS LATER.

HOWEVER, ACHERNAR DOES NOT STAND ALONE AMONG MEMBERS OF HER CLASS AS HAVING PRESERVED A PLACE IN THE HISTORY RECORDS. HER SISTER SHIPS XANTHII, ASTRAD AND ALFR ALL PLAYED PROMINENT PARTS IN THE KZINTI INCURSION OF 2272. XANTHII WAS ONE OF THE FEW STARSHIPS THAT SURVIVED THE KZINTI SNEAK ATTACK ON TAU CETI WHICH BEGAN THE CONFLICT. ASTRAD AND ALFR, ON THE OTHER HAND, BROUGHT THE WAR TO AN END BY SUCCESSFULLY TRACKING DOWN AND CAPTURING THE KZINTI PATRIARCH'S FLAGSHIP.

WHILE FOUR STARSHIPS OF THIS CLASS WERE UPGRADED TO MODEL MK IX/04 WHEN THE TIKOPAI CLASS WAS DEVELOPED, NINE REMAIN IN THEIR ORIGINAL CONFIGURATION. CURRENT PLANS CALL FOR THE MAINTENANCE OF THIS FORCE AT LEAST UNTIL A DECISION IS MADE CONCERNING THE FUTURE OF THE TRANS-WARP CRUISER.



ACHERNAR CLASS HEAVY CRUISER U.S.S. RIGIL KENTAURUS (NCC-1735) ON MANEUVERS WITH THE NEWLY REBUILT U.S.S. ENTERPRISE (NCC-1701)

CLASS LISTING OF ACHERNAR CLASS:

NAME	NCC NUMBER	COMMISSIONED	STATUS	NAME	NCC NUMBER	COMMISSIONED	STATUS
ACHERNAR	1732	12 MAR 2263	A4S	ASTRAD	1739	SD 6622.71	SRO
SOL	1733	17 AUG 2265	A0	MONDOLOY	1740	SD 6650.26	CONV
JUPITER	1734	SD 6509.34	CONV	ALFR	1741	SD 6654.41	SRF
RIGIL KENTAURUS	1735	SD 6536.21	A3N	THELONII	1742	SD 6674.28	A2S
QUINDAR	1736	SD 6573.47	CONV	XANTHII	1743	SD 6693.93	A3S
PROXIMA	1737	SD 6594.61	RDF	SIRIUS	1744	SD 6703.11	A4N
ANDROCUS	1738	SD 6601.73	CONV				

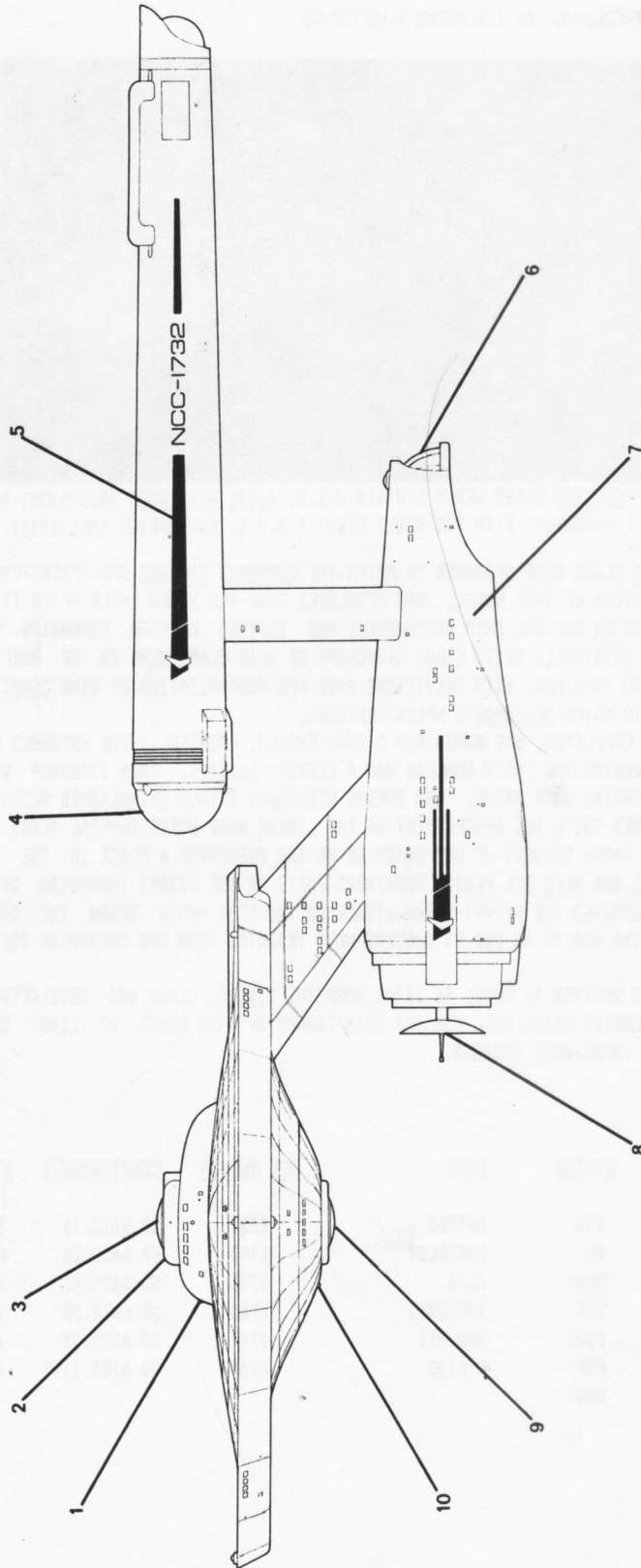

SUBFILE TWO: OUTBOARD PROFILE

RS: 480371-1
 TO: 01:04:01:09.22
 SPECIFICS:
 1. PHOTON TORPEDO EJECTOR-P/S
 2. BRIDGE
 3. TOPSIDE SPACE SENSOR ARRAY
 4. MATTER INTAKE
 5. STAR FLEET I.D. PENNANT
 6. FLIGHT DECK ACCESS DOORS
 7. SECONDARY HULL
 8. MAIN SENSOR & NAV. DEFELECTOR
 9. UNDERSIDE SPACE SENSOR ARRAY
 10. UNDERSIDE PHASER TURRET-P/S

UNITED FEDERATION OF PLANETS
 STAR FLEET DIVISION
 BUREAU OF OPERATIONS - OFFICE OF RECORDS

GENERAL PLANS	SPACECRAFT CLASS: CLASS ONE STARSHIP OF THE LINE
MODEL: MK-1X/03	NOMINAL CLASS: ACHERNAR
GENERATED BY: MASTERCOM SFHQ	SCALE: 1:1366





STAR FLEET REFERENCE REPORT

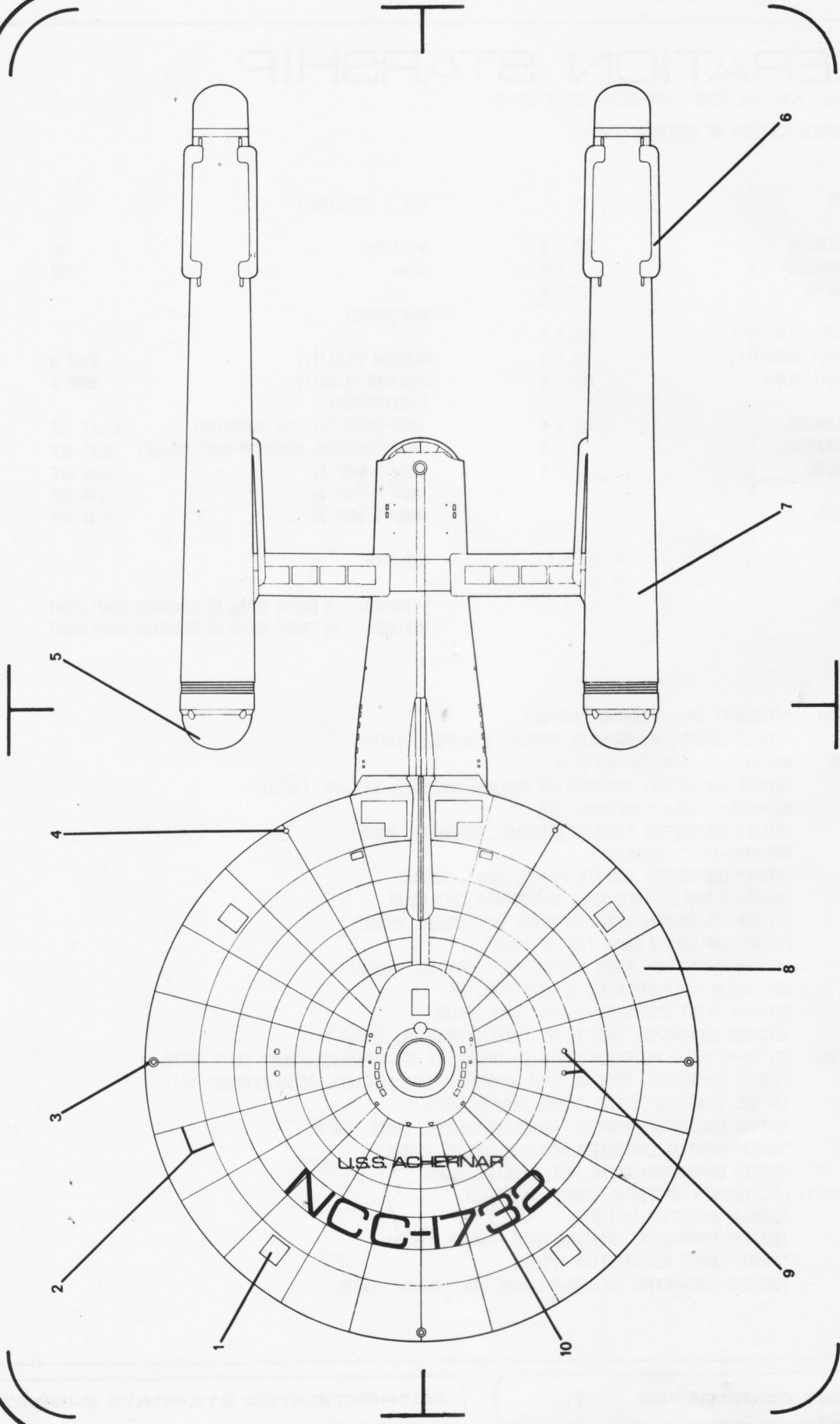

SUBFILE THREE: OUTBOARD TOP VIEW
 RS:480371-1
 TO:01:04:01:09.Z3
 SPECIFICS:
 1. AIRLOCK LIFT HATCH (4)
 2. DEFLECTOR GRID
 3. RUNNING LIGHT-1/8; P/S
 4. FORMATION LIGHT-P/S
 5. MATTER INTAKE
 6. INTERCOOLERS-P/S PER UNIT
 7. WARP PROPULSION MACELLE-P/S
 8. PRIMARY HULL
 9. TOPSIDE PHASER TURRETS-P/S
 10. NOMINAL & NUMERICAL I.D.

UNITED FEDERATION OF PLANETS STAR FLEET DIVISION BUREAU OF OPERATIONS - OFFICE OF RECORDS		SPACECRAFT CLASS: CLASS ONE STARSHIP OF THE LINE	
GENERAL PLANS	MODEL: HK-11/03	TYPE: HEAVY CRUISER	NOMINAL CLASS: ACHERNAR
GENERATED BY: MASTERCAM SFHQ	SCALE: 1:1366		





FEDERATION STARSHIP

CLASS ONE MK IX/03 SPECIFICATIONS

CURRENT SPECIFICATIONS OF ACHERNAR CLASS:

DIMENSIONS

OVERALL LENGTH: 288.6 M
 OVERALL DRAUGHT: 72.6 M
 OVERALL BEAM: 127.1 M

PRIMARY HULL LENGTH: 128.0 M
 PRIMARY HULL DRAUGHT: 32.5 M
 PRIMARY HULL BEAM: 127.1 M

NACELLE LENGTH: 153.6 M
 NACELLE DRAUGHT: 18.2 M
 NACELLE BEAM: 19.7 M

DISPLACEMENT

LIGHT: 186,000 M.T.
 STANDARD: 190,000 M.T.
 FULL LOAD: 195,000 M.T.

SHIP'S COMPLEMENT

OFFICERS: 43
 CREW: 387

PERFORMANCE

MAXIMUM VELOCITY: WARP 8
 CRUISING VELOCITY: WARP 6
 ACCELERATION:
 REST-ONSET CRITICAL MOMENTUM: 17.14 SEC
 ONSET CRITICAL MOMENTUM-WARP ENGAGE: 2.01 SEC
 WARP 1-WARP 4: 1.02 SEC
 WARP 4-WARP 6: .56 SEC
 WARP 6-WARP 8: 2.21 SEC

DURATION

STANDARD: 5 EARTH YEARS AT STANDARD COMPLEMENT
 MAXIMUM: 18 EARTH YEARS AT STANDARD COMPLEMENT

SYSTEMS

NAVIGATION: "STARMARK" WARP CELESTIAL GUIDANCE
 (SYSTEM CONTRACTOR: BENKULEN SYSTEMS, SINGAPORE, EARTH)

COMPUTERS: NCC-1732-34, 1736-39: SBT-R 44
 (SYSTEM CONTRACTOR: INTERSTELLAR BUSINESS MACHINES, CHICAGO, EARTH)
 NCC-1735: "FASFAX" DUOTRONIC III
 (SYSTEM CONTRACTOR: FARRANTI NEMONICS, BERKSHIRE, EARTH)
 NCC-1740-44: "T'SHARSISH"
 (SYSTEM CONTRACTOR: SHAKTIR TRIPEL, SURAK, VULCAN)

WEAPONS: PHASERS:3 BANKS/2 EACH RIN-6 INDEPENDENT TWIN MOUNT
 (SYSTEM CONTRACTOR: AGUSTA ANSADADO INC., FUZES, VENUS)
 PHOTON TORPEDOES:2 BANKS "AWALT" DIRECT
 (SYSTEM CONTRACTOR: RACAL WERFT F.M.C., STRATOS, ARDANA)

DEFENSE: RSAT/HIRAM FORCE FIELD AND DEFLECTOR SYSTEM
 FSTR/TAC FLEET STRATEGIC/TACTICAL DATA SYSTEM
 (SYSTEMS CONTRACTOR: TRESTIS AR TRESTIS, PANGAEAR, IZAR)

PROPULSION: (2) PB-47 MOD 3 DILITHIUM ENERGIZED ANTIMATTER CIRCUMFERENTIAL WARP DRIVE UNITS
 (SYSTEM CONTRACTOR: COCHRANE WARP DYNAMICS, MINOS AL RIJIL, ALPHA CENTAURI VII)
 (4) SBE SUBATOMIC UNIFIED ENERGY IMPULSE UNITS
 (SYSTEM CONTRACTOR: SCARBAK PROPULSION SYSTEMS, CAIRO, EARTH)
 "ASAKS" CHEMICAL COMBUSTION REACTION CONTROL SYSTEM
 (SYSTEM CONTRACTOR: DRAGE IJEK, AKSAJAK, ANDOR)

LIFE SUPPORT: CT-3/CENTRIS ARTIFICIAL GRAVITY GENERATOR
 "CORAZA" RADIATION SHIELDING
 (SYSTEMS CONTRACTOR: CRISTOBAL SM/S, MANILA, EARTH)
 "AMBRIX" WASTE REGENERATION SYSTEMS
 (SYSTEMS CONTRACTOR: JULLUNDUR-LAHORE LTD., BOMBAY, EARTH)

RS: 480371-1

TO: 01:04:01:09.29

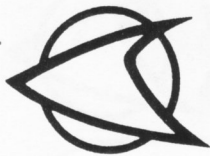

FEDERATION STARSHIP

CLASS ONE MK IX/05 BACKGROUND & CLASS LISTING

BACKGROUND OF ENTERPRISE CLASS:

FOR MANY YEARS, THE MK IX HEAVY CRUISER WAS THE LARGEST, FASTEST, AND MOST POWERFUL STARSHIP AT STAR FLEET'S DISPOSAL. WHILE OTHER STARSHIP TYPES NOW SURPASS IT IN EACH OF THESE SPECIFIC AREAS, NONE CAN MATCH THE HEAVY CRUISER FOR OVERALL VERSATILITY. AS SUCH, THESE STARSHIPS STILL FORM THE HEART OF THE FLEET, WITH THEIR MIX OF LONG-DURATION EXPLORATION AND POLICE/MILITARY TASKS BEST CHARACTERIZING STAR FLEET'S OVERALL MISSION.

ENTERPRISE CLASS HEAVY CRUISERS, OVER TWENTY EARTH-YEARS AFTER THE CLASS VESSEL'S COMMISSIONING, STILL REFLECT THE EPITOME OF THIS STARSHIP TYPE. SHIPS OF THE ENTERPRISE CLASS WERE ALL REBUILT FROM VESSELS OF THE BON HOMME RICHARD AND UPDATED CONSTITUTION CLASSES. WITH THE BURST OF EFFORT ON NEW WARP PROPULSION DESIGNS THAT FOLLOWED THE DEVELOPMENT OF THE LINEAR WARP DRIVE IN 2263, THE BUREAU OF SPACECRAFT PROPOSED THAT EITHER ENTERPRISE OR LEXINGTON FORM THE BASIS FOR A NEW CLASS OF HEAVY CRUISERS INCORPORATING THE LATEST TECHNOLOGICAL DEVELOPMENTS. ENTERPRISE WAS THE FIRST TO RETURN FROM ITS FIVE-YEAR DEEP SPACE MISSION, AND AS SUCH WAS CHOSEN FOR FIRST REBUILDING.

ENTERPRISE WAS ORIGINALLY BUILT DURING THE EARLY 2220'S, THE SECOND CONSTITUTION CLASS HEAVY CRUISER ORDERED. DURING OVERHAUL IN 2260 IT HAD BEEN UPDATED TO BON HOMME RICHARD SPECIFICATIONS. IT THUS WENT INTO DRYDOCK IN 2266 AN OLD, YET NEW, SPACECRAFT--AND ONE ALREADY LEGENDARY AFTER 45 EARTH-YEARS SERVICE UNDER THE COMMAND OF SUCH LUMINARIES OF STAR FLEET'S PAST AS ROBERT APRIL, CHRISTOPHER PIKE, AND JAMES KIRK.

REBUILDING WAS SO THOROUGH THAT, IN EFFECT, ALL THAT REMAINED FROM THE OLD STARSHIP WAS ITS SPIRIT, SINCE ITS MASS WAS COMPLETELY BROKEN DOWN AND REMOVED INTO A NEW FORM. WITH THE CONTINUING SPIRIT, HOWEVER, CAME ENTERPRISE'S LONGSTANDING LUCK FOR FINDING ADVENTURE--OR FOR HAVING ADVENTURE FIND IT. WEEKS BEFORE SCHEDULED RELAUNCHING, THE BARELY-COMPLETED STARSHIP WAS PRESSED INTO SERVICE TO INTERCEPT AND ENGAGE WHAT WAS LATER REVEALED TO BE THE RETURNING VOYAGER PROBE. ENTERPRISE'S FORMER COMMANDER, REAR ADMIRAL JAMES KIRK, WAS GIVEN TEMPORARY COMMAND OF THE STARSHIP FOR THIS MISSION.

THE LOSS OF THE SHIP'S CAPTAIN, WILLARD DECKER, DURING THE ENCOUNTER RESULTED IN KIRK'S BEING RE-AWARDED PERMANENT COMMAND. OVER THE NEXT DECADE, HE CAPTAINED THE STARSHIP THROUGH TWO FIVE-YEAR DEEP-SPACE MISSIONS. IT WAS DURING THE FIRST OF THESE MISSIONS THAT ENTERPRISE SERVED AS KIRK'S FLAGSHIP AS HE COMMANDED A LARGE TASK FORCE AGAINST THE KZIN, EMPLOYING THE NOW-FAMOUS "ZETARIAN SQUEEZE" MANUEVER TO FORCE MUCH OF THE ENEMY FLEET INTO THE GRAVITATIONAL FIELD OF A NEUTRON STAR. THE ACTION LED TO THE CAPTURE OF THE KZINTI PATRIARCH'S FLAGSHIP BY STARSHIPS ASTRAD AND ALFR, AND TO THE CONCLUSION OF HOSTILITIES.

FOLLOWING THE RETURN OF ENTERPRISE FROM ITS LAST DEEP-SPACE MISSION IN 2278, COMMAND WAS TRANSFERRED TO COMMODORE GREGORY WESTLAKE, AND THE STARSHIP WAS DEPLOYED AS FLAGSHIP OF THE TERRAN DEFENSE GROUP, FLEET QUADRANT ZERO. IN 2284, AT THE REQUEST OF ADMIRAL KIRK (NOW DIRECTOR OF PERSONNEL), ENTERPRISE WAS REASSIGNED TO STAR FLEET ACADEMY FOR SERVICE ON ROTATION AS A MIDSHIPMAN TRAINING VESSEL.

IT WAS AT THIS TIME THAT THE REQUIREMENTS ANALYSIS BOARD (UNDER THE DIRECTION OF FLEET ADMIRAL HARRY MORROW, SD 8210.01) ISSUED ITS CONTROVERSIAL RECOMMENDATION FOR THE DECOMMISSIONING OF ENTERPRISE CLASS STARSHIPS AS MORE VESSELS OF THE CHEAPER, BUT LESS VERSATILE, IKOPAI CLASS BECAME AVAILABLE. SUPPORTERS OF THE PROPOSAL POINTED TO AN ASSERTED DUPLICATION OF EFFORT THAT WOULD ARISE WERE STAR FLEET TO CONSTRUCT MORE IKOPAI CLASS HEAVY CRUISERS, EXCELSIOR CLASS SPACE CONTROL SHIPS, AND MAINTAIN THE ENTERPRISE CLASS FLEET. OPPONENTS CHARGED THAT THE FLEET WAS SCRAPPING ITS BEST STARSHIPS UNDER PRESSURE FROM CONTRACTORS IN ORDER TO PROVIDE AN EXCUSE FOR BUYING MORE VESSELS. FINALLY, IN APRIL 2287, THE CHIEF OF STAR FLEET COMMAND ORDERED THAT ALL REMAINING ENTERPRISE CLASS STARSHIPS BE RETAINED IN ACTIVE SERVICE, AND THAT THEY UNDERGO SYSTEMS REFURBISHING DURING REGULAR OVERHAULS TO PERMIT THEM TO ONCE AGAIN BE ASSIGNED TO DEEP-SPACE EXPLORATION. FOR THE LEGENDARY CLASS VESSEL, HOWEVER, THIS DECISION CAME TOO LATE. IN RECENT ACTION (THE DETAILS OF WHICH REMAIN CLASSIFIED AT A HIGHER SECURITY LEVEL), ENTERPRISE WAS DESTROYED. IT THUS JOINS ITS SISTER SHIP HOOD ON THE LIST OF VESSELS DESTROYED IN SERVICE. PLANS FOR THE REFURBISHING AND REASSIGNMENT OF THE SIX REMAINING VESSELS OF THIS CLASS ARE UNCHANGED BY THESE DEVELOPMENTS, HOWEVER, AND WILL BE CARRIED OUT OVER THE NEXT THREE EARTH-YEARS.

CLASS LISTING OF ENTERPRISE CLASS:

NAME	NCC NUMBER	REBUILT	STATUS	NAME	NCC NUMBER	REBUILT	STATUS
ENTERPRISE	1701	JAN 2266-AUG 2267	D	EXETER	1706	FEB 2268-OCT 2269	A3N
FARRAGUT	1702	APR 2268-NOV 2269	A2N	HOOD	1707	SEP 2269-FEB 2271	D
LEXINGTON	1703	MAY 2269-DEC 2270	A4S	ELDORADO	1722	OCT 2273-JAN 2275	A2S
EXCALIBUR	1705	JAN 2268-SEP 2269	A0	KREIGER	1726	MAR 2271-OCT 2272	A1S

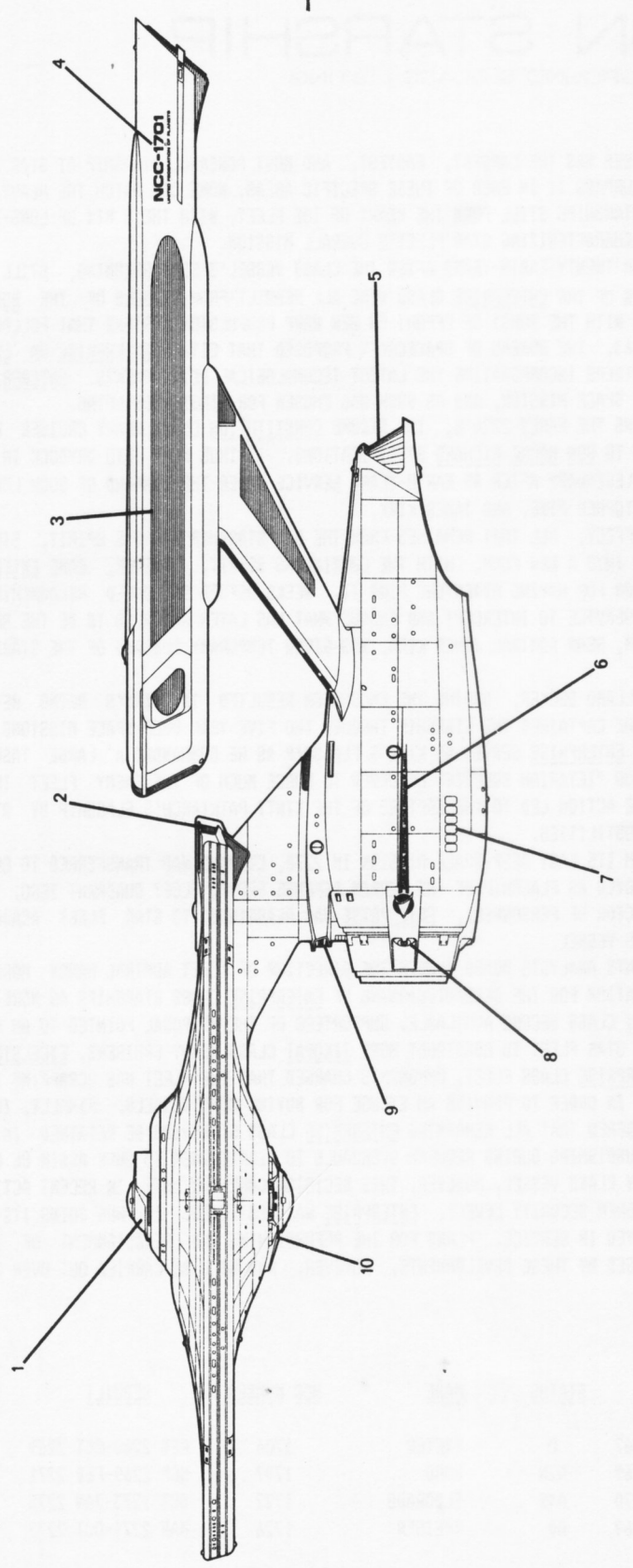
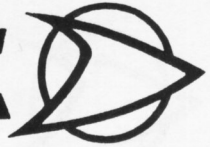

SUBFILE TWO: OUTBOARD PROFILE

RS: 480371-3

TO: 01:04:01:09.42

SPECIFICS:

- 1. BRIDGE
- 2. IMPULSE PROPULSION HOUSING
- 3. WARP PROPULSION NACELLE-P/S
- 4. NUMERICAL I.D.: REGISTRY
- 5. FLIGHT DECK ACCESS DOORS
- 6. STAR FLEET I.D. PENNANT
- 7. BOTANICAL SECTION WINDOWS-P/S
- 8. SPACE ENERGY FIELD SENSOR (3)
- 9. PHOTON TORPEDO EJECTOR-P/S
- 10. MAIN SENSOR ARRAY

UNITED FEDERATION OF PLANETS
STAR FLEET DIVISION
 BUREAU OF OPERATIONS - OFFICE OF RECORDS

GENERAL PLANS	SPACECRAFT CLASS: CLASS ONE STARSHIP OF THE LINE
MODEL: MK-IX/05	NOMINAL CLASS: ENTERPRISE
GENERATED BY: MASTERCOM SFHQ	SCALE: 1:1366





STAR FLEET REFERENCE REPORT

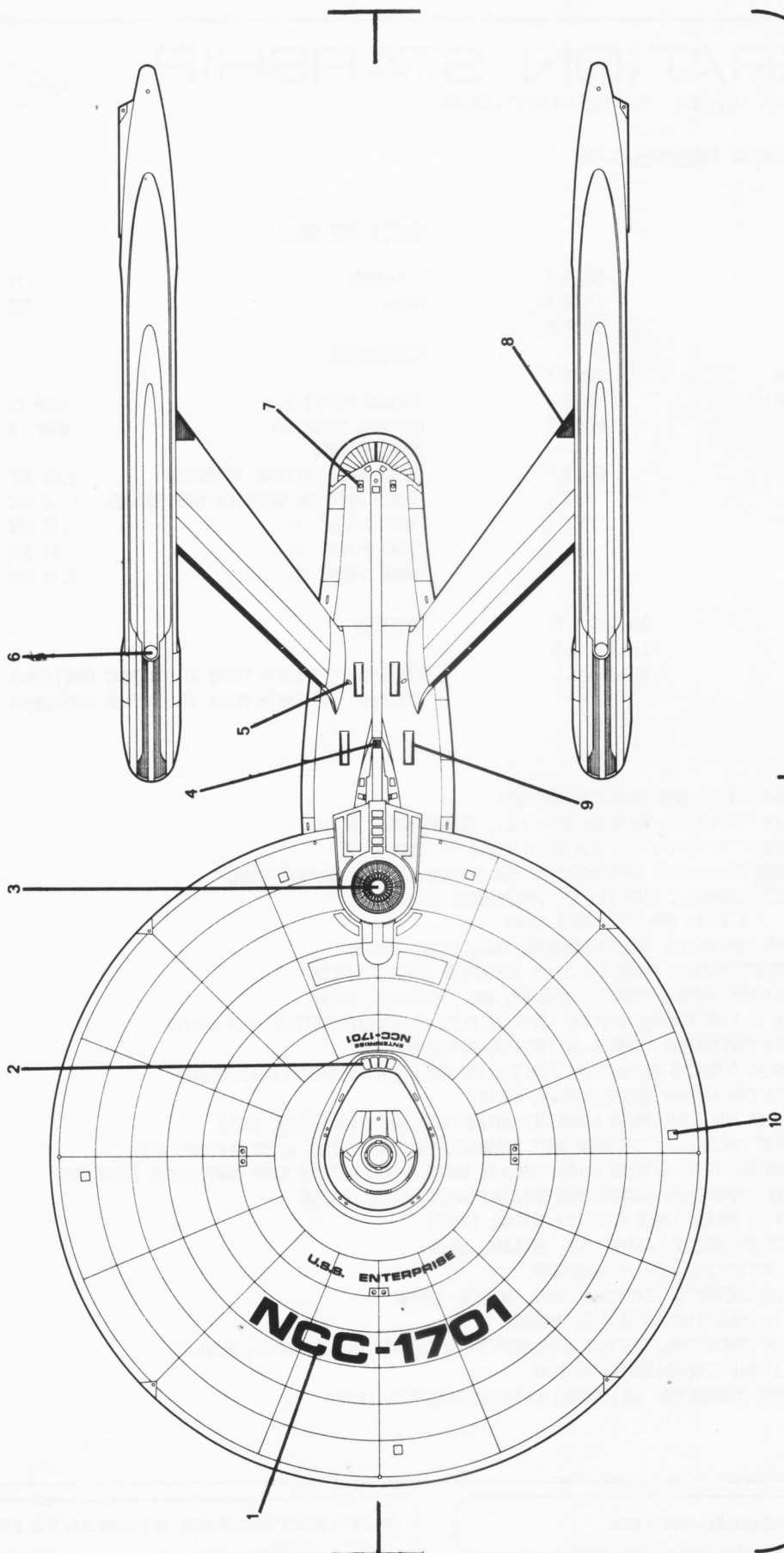

SUBFILE THREE: OUTBOARD TOP VIEW

RS: 480371-3

TO: 01:04:01:09-43

SPECIFICS:

- 1. NOMINAL & NUMERICAL I.D.
- 2. OFFICERS' LOUNGE WINDOWS
- 3. IMPULSE DEFLECTION CRYSTAL
- 4. PHOTON WEAPONS EXHAUST VENT
- 5. SELF-ILLUMINATION LIGHT
- 6. MAGMATOMIC CRYSTAL
- 7. STERN PHASER TURRET-P/S
- 8. EMERGENCY FLUSH VENT (6)
- 9. AFT MANEUVERING THRUSTER (4)
- 10. ATRLOCK LIFT HATCH (5)

UNITED FEDERATION OF PLANETS		SPACECRAFT CLASS:	
STAR FLEET DIVISION		CLASS ONE STARSHIP OF THE LINE	
BUREAU OF OPERATIONS - OFFICE OF RECORDS			
GENERAL PLANS	MODEL:	TYPE:	NOMINAL CLASS:
	MK-IX/05	HEAVY CRUISER	ENTERPRISE
GENERATED BY:	SCALE:		
MASTERCORP SFHG	1:1366		





FEDERATION STARSHIP

CLASS ONE MK IX/05 SPECIFICATIONS

CURRENT SPECIFICATIONS OF ENTERPRISE CLASS:

DIMENSIONS

OVERALL LENGTH: 304.8 M
 OVERALL DRAUGHT: 71.3 M
 OVERALL BEAM: 141.7 M

PRIMARY HULL LENGTH: 146.3 M
 PRIMARY HULL DRAUGHT: 32.9 M
 PRIMARY HULL BEAM: 141.7 M

NACELLE LENGTH: 154.8 M
 NACELLE DRAUGHT: 18.3 M
 NACELLE BEAM: 12.6 M

DISPLACEMENT

LIGHT: 206,000 M.T.
 STANDARD: 210,000 M.T.
 FULL LOAD: 215,000 M.T.

SHIP'S COMPLEMENT

OFFICERS: 72
 CREW: 428

PERFORMANCE

MAXIMUM VELOCITY: WARP 12
 CRUISING VELOCITY: WARP 8
 ACCELERATION:
 REST-ONSET CRITICAL MOMENTUM: 8.51 SEC
 ONSET CRITICAL MOMENTUM-WARP ENGAGE: 1.12 SEC
 WARP 1-WARP 4: .78 SEC
 WARP 4-WARP 8: .67 SEC
 WARP 8-WARP 12: 2.13 SEC

DURATION

STANDARD: 5 EARTH YEARS AT STANDARD COMPLEMENT
 MAXIMUM: 22 EARTH YEARS AT STANDARD COMPLEMENT

SYSTEMS

NAVIGATION: "DRAGON'S EYE" WARP CELESTIAL GUIDANCE
 (SYSTEM CONTRACTOR: VALDEMAR NCS, INC., COPENHAGEN, EARTH)

COMPUTERS: "DAYSTROM" DUOTRONIC III WITH MULTITRONIC M-7 SUPPLEMENT
 (SYSTEMS CONTRACTOR: DAYSTROM COMPUTER SYSTEMS, INC., LUNAPORT, LUNA)

WEAPONS: PHASERS: 6 BANKS/2 EACH RIM 12C INDEPENDENT TWIN MOUNT
 6 BANKS RSM 14B SINGLE MOUNT
 (SYSTEM CONTRACTOR: AGUSTA ANSADADO INC., FUZES, VENUS)

DEFENSE: "LANCELOT" PRIMARY FORCE FIELD AND DEFLECTOR CONTROL SYSTEM
 (SYSTEM CONTRACTOR: PRENTICE-SCHAFFER, INC., MARSPOET, MARS)
 MENTOR II FIRE CONTROL SYSTEM; FSTR/TAC FLEET STRATEGIC/TACTICAL DATA SYSTEM
 (SYSTEM CONTRACTOR: TRESTIS AR TRESTIS, PANGAEAR, IZAR)
 CGCP/SCDS CLOAKING GENERATION, PENETRATION AND STASIS COUNTERMEASURE SYSTEM
 (SYSTEM CONTRACTOR: HYCOR, WOBURN, EARTH)

PROPULSION: (2) LN-64 MOD 3 DILITHIUM ENERGIZED ANTIMATTER LINEAR WARP DRIVE UNITS
 (SYSTEMS CONTRACTOR: COCHRANE WARP DYNAMICS, MINDS AL RIJIL, ALPHA CENTAURI VII)
 (2) RSM SUBATOMIC UNIFIED ENERGY IMPULSE UNITS; QASR PARTICLE BEAM MANUEVERING THRUSTERS
 (SYSTEM CONTRACTOR: SCARBAK PROPULSION SYSTEMS, CAIRO, EARTH)
 "TRENTIS" PULSED LASER REACTION CONTROL SYSTEM
 (SYSTEM CONTRACTOR: DRAGE IJEK, AKSAJAK, ANDOR)

LIFE SUPPORT: MC-3C ARTIFICIAL GRAVITY GENERATOR
 (SYSTEM CONTRACTOR: CRISTOBAL SM/S, MANILA, EARTH)
 "RASTIS" RADIATION PROTECTION PACKAGE
 (SYSTEM CONTRACTOR: TIDJIKJA/ATAR ASSOCIATED INDUSTRIES, RASTARIBI, REGULUS)
 "CERIX" WASTE REGENERATION SYSTEMS
 (SYSTEMS CONTRACTOR: JULLUNDUR-LAHORE LTD., BOMBAY, EARTH)

RS: 480371.3

TO:01:04:01:09.49



FEDERATION STARSHIP

CLASS ONE MK X/01 BACKGROUND & CLASS LISTING

BACKGROUND OF FEDERATION CLASS:

THE IDEA OF A DREADNOUGHT WITH THREE WARP DRIVE UNITS WAS FIRST PROPOSED IN THE MID-2220'S. AND YET, THE HIGH COST AND LACK OF ANY IMPENDING THREATS RESULTED IN NO ACTION BEING TAKEN FOR OVER TWENTY YEARS. NOT UNTIL THE LESSONS OF THE FOUR YEARS WAR WERE LEARNED DID THE REQUIREMENTS ANALYSIS BOARD DREDGE UP THE DREADNOUGHT PLAN. THE FIRM OF ARBING AND LIDDE WERE THEN CONTRACTED TO DEVELOP A DREADNOUGHT-TYPE STARSHIP DESIGN UTILIZING THE SAME GENERAL COMPONENT SYSTEM IN USE FOR MOST OF THE CLASS ONE FLEET. THEIR EVENTUAL PROPOSAL MET WITH A MIXED REACTION. CALLING FOR A THREE WARP DRIVE UNIT DESIGN AS HAD THE EARLIER PLAN, ARBING AND LIDDE ADDED THE CONSIDERATION OF VERSATILITY TO THOSE OF STRENGTH AND POWER, AND THUS ATTACHED THE CENTERLINE MACELLE TO THE SHIP'S PRIMARY, RATHER THAN SECONDARY HULL. THE RESULTING FIELD

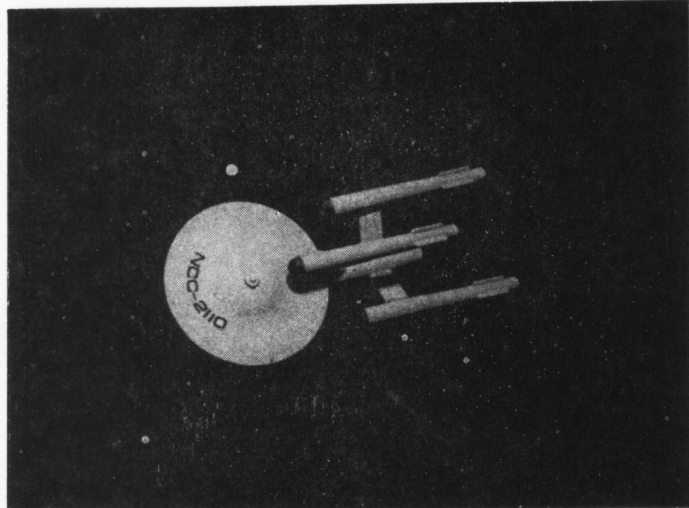

U.S.S. DIRECTORATE (NCC-2110) ON PATROL NEAR KLINGON SPACE

DISTORTION DIMINISHED THE DESIGN'S WARP DYNAMIC FACTOR CONSIDERABLY. AND YET, THE FIRM MAINTAINED, THE ADVANTAGE OF HAVING A WARP CAPABLE PRIMARY HULL IN THE EVENT OF MAJOR BATTLE DAMAGE TO THE SECONDARY OVERRULED SPEED CONSIDERATIONS. THE MEMBERS OF THE PROCUREMENTS BOARD WERE FIERCELY SPLIT OVER THE PROPOSAL, AND QUITE LIKELY WOULD HAVE LET IT DIE HAD NOT THE DIRECTOR OF THE MILITARY STAFF COMMITTEE, ADMIRAL SIDRE AEL SARDELAS, THROWN HIS SUPPORT BEHIND THE DREADNOUGHT PLAN AT THE LAST MOMENT. EVEN SO, THE OPPONENTS MADE THEIR DISAPPROVAL KNOWN BY SLASHING THE NUMBER OF DREADNOUGHTS TO BE BUILT FROM TWENTY TO TWELVE.

CONSTRUCTED OVER THE NEXT TWELVE YEARS, THE FEDERATION CLASS DREADNOUGHTS WERE ALL IN SERVICE BY 2263. FOR ALMOST A DECADE THEY SERVED AS ROTATING FLAGSHIPS FOR THE VARIOUS QUADRANT FLEETS. WITH THE DEVELOPMENT OF LINEAR WARP TECHNOLOGY HOWEVER, THE NINE OLDEST STARSHIPS WERE REBUILT, FORMING AN UPRATED FEDERATION CLASS (MK X/02). THESE, ALONG WITH DREADNOUGHTS OF THE ASCENSION CLASS, NOW SERVE AS THE FLEET'S FLAGSHIPS, WITH THE THREE REMAINING STARSHIPS OF THE OLD FEDERATION CLASS IN RESERVE FOR USE SHOULD THE NEED ARISE.

CLASS LISTING OF FEDERATION CLASS:

<u>NAME</u>	<u>NCC NUMBER</u>	<u>COMMISSIONED</u>	<u>STATUS</u>	<u>NAME</u>	<u>NCC NUMBER</u>	<u>COMMISSIONED</u>	<u>STATUS</u>
FEDERATION	2100	24 JUL 2255	CONV	STAR SYSTEM	2107	27 JUL 2260	CONV
STAR LEAGUE	2101	SD 5508.48	CONV	AFFILIATION	2108	SD 5008.54	CONV
UNIFICATUM	2102	16 AUG 2258	CONV	CONCORDAT	2109	03 APR 2261	CONV
COMPACTAT	2103	21 OCT 2259	CONV	DIRECTORATE	2110	07 DEC 2261	SR0
CORPORATION	2104	SD 5911.42	CONV	ORGANIZATION	2111	19 JAN 2263	SRF
KONKORDIUM*	2106	SD 5991.34	CONV	STAR UNION	2112	26 APR 2263	SRF

*2105 ASSIGNED TO COMMAND CRUISER USS BALSON

RS: 480371.1

TO: 01:04:01:10.01

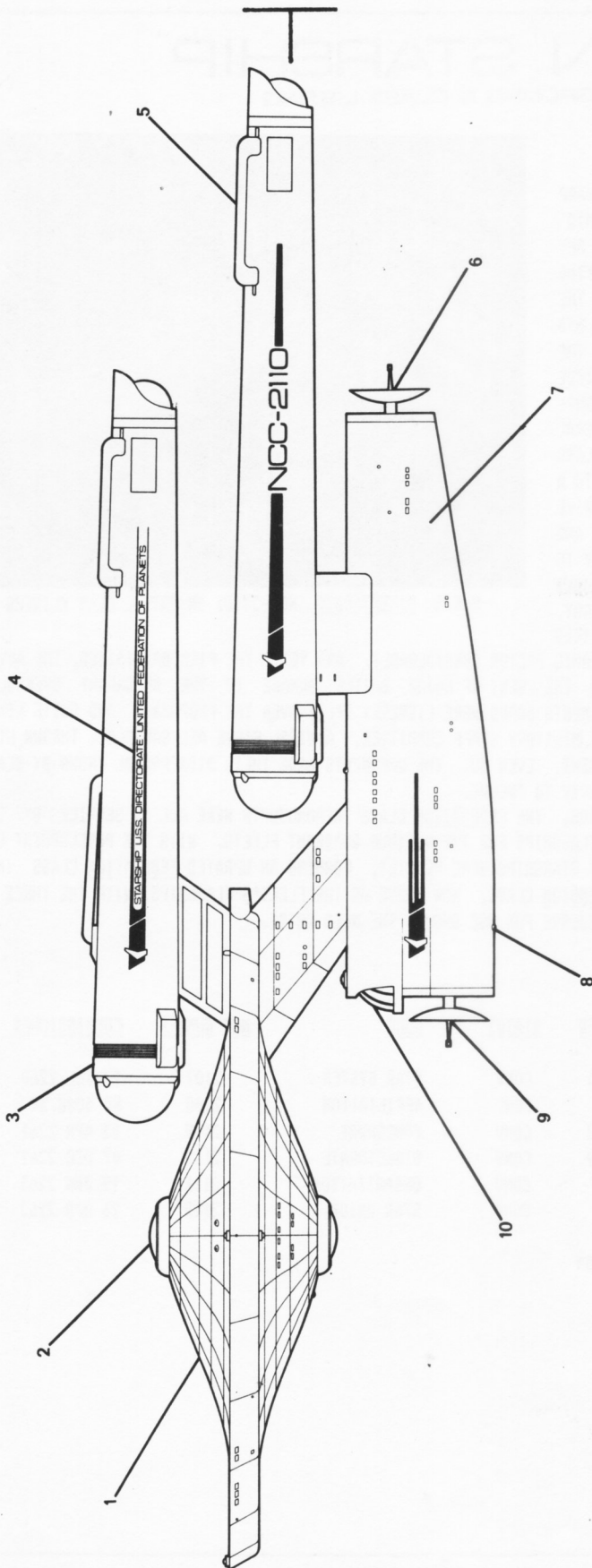

SUBFILE TWO: OUTBOARD PROFILE

RS: 480371-1

TO: 01:04:01:10.02

SPECIFICS:

- 1. PRIMARY HULL
- 2. SPACE SENSOR ARRAY-T/8
- 3. WARP PROPULSION NACELLE-CTR
- 4. STAR FLEET I.D. PENNANT
- 5. INTERCOOLERS-P/S PER UNIT
- 6. AFT SENSOR & NAV. DEFLECTOR
- 7. SECONDARY HULL
- 8. LOWER PHASER TURRET-P/S
- 9. FORE SENSOR & NAV. DEFLECTOR
- 10. FLIGHT DECK ACCESS DOORS

UNITED FEDERATION OF PLANETS STAR FLEET DIVISION BUREAU OF OPERATIONS - OFFICE OF RECORDS	
GENERAL PLANS MODEL: MK-X/01 GENERATED BY: MASTERCOM SFHQ	SPACECRAFT CLASS: CLASS ONE STARSHIP OF THE LINE NOMINAL CLASS: DREADNOUGHT FEDERATION SCALE: 1:1366





STAR FLEET REFERENCE REPORT

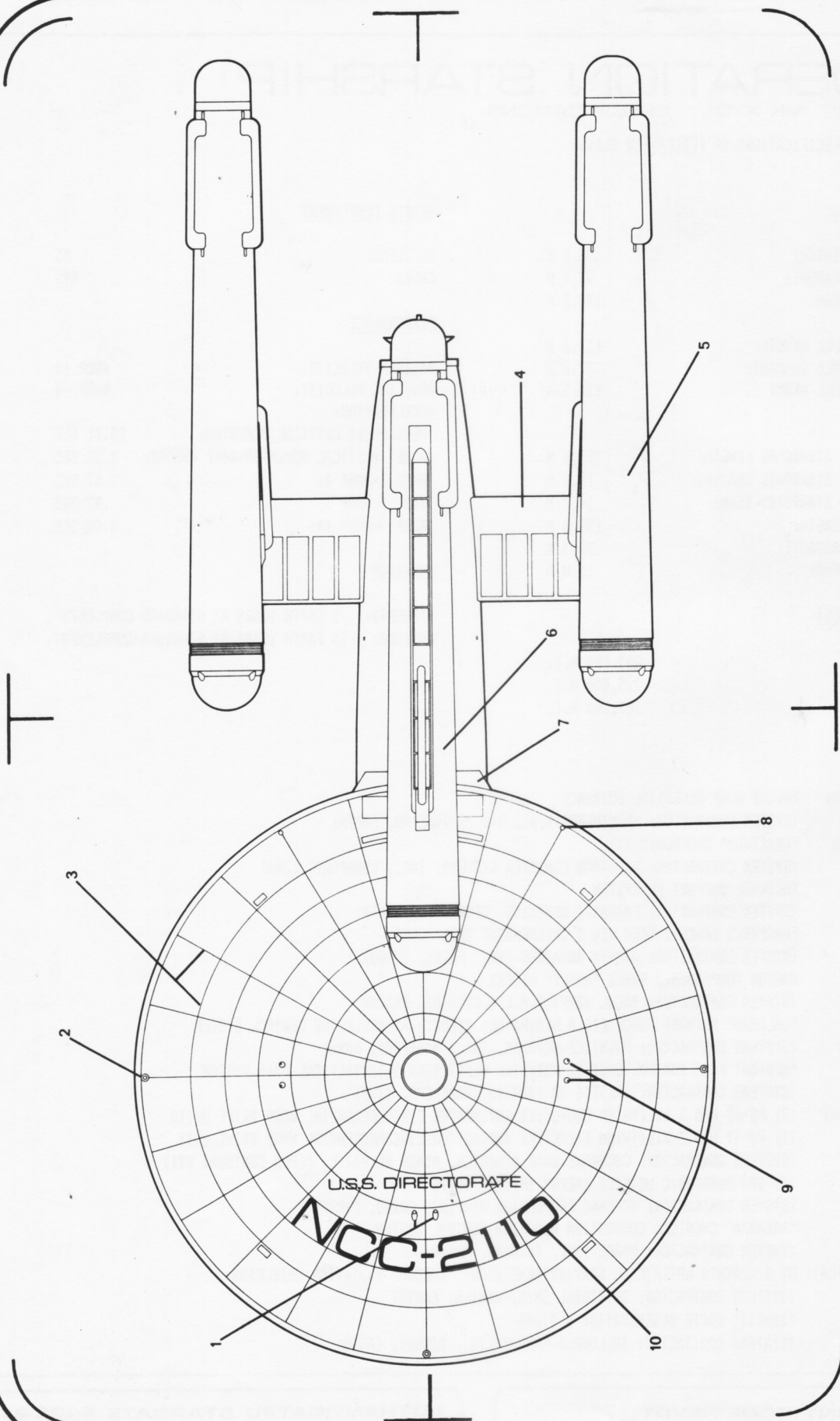

SUBFILE THREE: OUTBOARD TOP VIEW

RS: 480371-1

TO: 01:04:01:10.03

SPECIFICS:

- 1. PHOTON TORPEDO EJECTORS
- 2. RUNNING LIGHT-T7B; P/S
- 3. REFLECTOR GRID
- 4. NACELLE SUPPORT PYLON
- 5. WARP PROPULSION NACELLE-P/S
- 6. WARP PROPULSION NACELLE-CTR
- 7. IMPULSE PROPULSION HOUSING
- 8. FORMATION LIGHT-P/S
- 9. TOPSIDE PHASER TURRETS-P/S
- 10. NOMINAL & NUMERICAL I.D.

UNITED FEDERATION OF PLANETS		SPACECRAFT CLASS:	
STAR FLEET DIVISION		CLASS ONE STARSHIP OF THE LINE	
BUREAU OF OPERATIONS - OFFICE OF RECORDS		NOMINAL CLASS:	
GENERAL PLANS	TYPE:	FEDERATION	
MODEL: MK-X/01	DREADNOUGHT	SCALE: 1:1366	
GENERATED BY:		MASTERCOM SFHQ	





FEDERATION STARSHIP

CLASS ONE MK X/01 SPECIFICATIONS

CURRENT SPECIFICATIONS OF FEDERATION CLASS:

DIMENSIONS

OVERALL LENGTH: 306.8 M
 OVERALL DRAUGHT: 93.9 M
 OVERALL BEAM: 135.5 M

PRIMARY HULL LENGTH: 137.8 M
 PRIMARY HULL DRAUGHT: 37.6 M
 PRIMARY HULL BEAM: 135.5 M

NACELLES:
 PORT AND STARBOARD LENGTH: 153.6 M
 PORT AND STARBOARD DRAUGHT: 18.2 M
 PORT AND STARBOARD BEAM: 19.7 M
 CENTER LENGTH: 153.6 M
 CENTER DRAUGHT: 20.3 M
 CENTER BEAM: 16.8 M

DISPLACEMENT

LIGHT: 283,000 M.T.
 STANDARD: 285,000 M.T.
 FULL LOAD: 287,500 M.T.

SYSTEMS

NAVIGATION: NAVCAS WARP CELESTIAL GUIDANCE
 (SYSTEM CONTRACTOR: PRINZHENRI S.N., RIO DE JANEIRO, EARTH)

COMPUTERS: "DAYSTROM" DUOTRONIC III
 (SYSTEM CONTRACTOR: DAYSTROM COMPUTER SYSTEMS, INC., LUNAPORT, LUNA)
 TACINTEL SUPPORT SUBSYSTEM
 (SYSTEM CONTRACTOR: FARRANTI NEMONICS, BERKSHIRE, EARTH)

WEAPONS: PHASERS: 5 BANKS/2 EACH RIN-9 INDEPENDENT TWIN MOUNT
 (SYSTEM CONTRACTOR: AGUSTA ANSADADO INC., FUZES, VENUS)
 PHOTON TORPEDOES: 2 BANKS "AWALT" DIRECT
 (SYSTEM CONTRACTOR: RACAL WERFT F.M.C., STRATOS, ARDANA)

DEFENSE: "GALAHAD" PRIMARY FORCE FIELD GENERATOR; "TEMUCHIN" DEFLECTOR CONTROL SYSTEM
 (SYSTEMS CONTRACTOR: PRENTICE-SCHAFFER, INC., MARSPORT, MARS)
 "MENTOR" FIRE CONTROL SYSTEM; FSTR/TAC FLEET STRATEGIC/TACTICAL DATA SYSTEM
 (SYSTEMS CONTRACTOR: TRESTIS AR TRESTIS, PANGAEAR, IZAR)

PROPULSION: (2) PB-47 MOD 3 DILITHIUM ENERGIZED ANTIMATTER CIRCUMFERENTIAL WARP DRIVE UNITS
 (1) PB-47 MOD 2 DILITHIUM ENERGIZED ANTIMATTER CIRCUMFERENTIAL WARP DRIVE UNIT
 (SYSTEMS CONTRACTOR: COCHRANE WARP DYNAMICS, MINOS AL RIJIL, ALPHA CENTAURI VII)
 (4) SBA SUBATOMIC UNIFIED ENERGY IMPULSE UNITS
 (SYSTEM CONTRACTOR: SCARBAK PROPULSION SYSTEMS, CAIRO, EARTH)
 "ARKANJA" CHEMICAL COMBUSTION REACTION CONTROL SYSTEM
 (SYSTEM CONTRACTOR: ORAGE IJEK, AKSAJAK, ANDOR)

LIFE SUPPORT: CT-3/CENTRIS ARTIFICIAL GRAVITY GENERATOR; "ESCUDO" RADIATION SHIELDING
 (SYSTEMS CONTRACTOR: CRISTOBAL SM/S, MANILA, EARTH)
 "AMBRIX" WASTE REGENERATION SYSTEMS
 (SYSTEMS CONTRACTOR: JULLUNDUR-LAHORE LTD., BOMBAY, EARTH)

SHIP'S COMPLEMENT

OFFICERS: 55
 CREW: 445

PERFORMANCE

MAXIMUM VELOCITY: WARP 10
 CRUISING VELOCITY: WARP 8
 ACCELERATION:
 REST-ONSET CRITICAL MOMENTUM: 25.71 SEC
 ONSET CRITICAL MOMENTUM-WARP ENGAGE: 2.27 SEC
 WARP 1-WARP 4: .67 SEC
 WARP 4-WARP 7: .92 SEC
 WARP 7-WARP 10: 3.04 SEC

DURATION

STANDARD: 5 EARTH YEARS AT STANDARD COMPLEMENT
 MAXIMUM: 20 EARTH YEARS AT STANDARD COMPLEMENT

RS: 480371.1

TO: 01:04:01:10.09

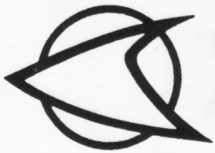

FEDERATION STARSHIP

CLASS ONE MK X/02 BACKGROUND & CLASS LISTING

BACKGROUND OF FEDERATION (UPRATED) CLASS:

THE PROPOSAL TO BUILD DREADNOUGHTS OF THE ORIGINAL FEDERATION CLASS MET WITH GREAT RESISTANCE. WHILE NOT CREATING AS MUCH CONTROVERSY, PLANS TO UPGRADE THESE STARSHIPS TO REFLECT LINEAR WARP TECHNOLOGY DID NOT WIN INSTANT APPROVAL. SINCE THE SUCCESSFUL REDESIGN OF HEAVY CRUISERS (RESULTING IN THE ENTERPRISE CLASS) VARIOUS PARTIES BOTH IN AND OUT OF STAR FLEET HAD BEEN CALLING FOR A MASSIVE OVERHAUL OF MANY EXISTING CLASS ONE STARSHIPS. THE KZNTI INCURSION OF 2272 GAVE IMPETUS TO THEIR EFFORTS, AND ONE RESULT WAS THE APPROVAL OF THE FEDERATION DREADNOUGHT REDESIGN PLAN.

ORIGINALLY, THE REDESIGN OF ALL TWELVE FEDERATION CLASS DREADNOUGHTS WAS PLANNED. CONSTRUCTION STARTS ON ALL VESSELS WERE SLATED TO TAKE PLACE BY THE END OF 2276. THE FEDERATION COUNCIL TRIMMED THESE PLANS CONSIDERABLY BEGINNING IN 2275 AS PART OF A LARGER MOVE RESPONDING TO REVELATIONS OF STAR FLEET COVERT ACTIVITIES AGAINST THE KZIN PRIOR TO THEIR ATTACK ON TAU CETI. AFTER MUCH MANEUVERING, REBUILDING OF NINE OF TWELVE STARSHIPS, WITH STARTS STRETCHING TO MID-2278, WERE APPROVED.

CONSIDERABLE ALTERATIONS WERE MADE TO THE OLD DREADNOUGHTS. ALONG WITH THE WARP DYNAMIC STREAMLINING AND SYSTEMS MODIFICATIONS CHARACTERISTIC OF MOST LINEAR DRIVE UPGRADES CAME A RELOCATION OF THE BRIDGE AND FLIGHT DECK FACILITIES. THE BRIDGE WAS MOVED FROM ITS PREVIOUS LOCATION DEEP INSIDE THE PRIMARY HULL TO THE TOPSIDE WHERE, THOUGH MORE VULNERABLE, IT COULD HAVE THE EMERGENCY DETACH FEATURE OF BRIDGES ON MOST CLASS ONE STARSHIPS. THE FLIGHT DECK WAS MOVED FROM THE FOREWARD TO THE AFT SECTION OF THE SECONDARY HULL TO PROVIDE FOR THE INTERMIX AND CONTAINMENT AREAS NECESSARY ON LINEAR DRIVE UPGRADES.

DREADNOUGHTS OF THIS CLASS HAVE SHOWN THEIR BATTLE DURABILITY AND SYSTEMS CAPABILITIES IN TRIALS AND ACTUAL ENCOUNTERS. AS SUCH, THEY ARE WELL SUITED FOR THEIR DUTY AS FLAGSHIPS FOR MANY OF THE SUBQUADRANT FLEETS AND SYSTEM DEFENSE FORCES. IN THIS ROLE THEY HAVE OVERCOME THE DERISION OF EARLIER OPPONENTS TO WIN RESPECT, CONFIDENCE, AND MOST IMPORTANTLY, A PLACE IN STAR FLEET'S LONG-TERM PLANNING.

CLASS LISTING OF FEDERATION (UPRATED) CLASS:

NAME	NCC NUMBER	REBUILT	STATUS	NAME	NCC NUMBER	REBUILT	STATUS
FEDERATION	2100	NOV 2274-AUG 2276	ATAC	KONKORDIUM	2106*	MAY 2278-FEB 2280	ATAC
STAR LEAGUE	2101	JUNE 2275-JAN 2277	ATAC	STAR SYSTEM	2107	JULY 2276-JAN 2278	ATAC
UNIFICATUM	2102	APR 2273-MAR 2275	ATAC	AFFILIATION	2108	JUNE 2274-MAR 2276	ATAC
COMPACTAT	2103	APR 2273-JAN 2275	ATAC	CONCORDAT	2109	NOV 2275-MAY 2277	ATAC
CORPORATION	2104	MAY 2277-DEC 2278	ATAC				

*2105 ASSIGNED TO COMMAND CRUISER USS BALSON

RS: 480371.5

TO: 01:04:01:10.11

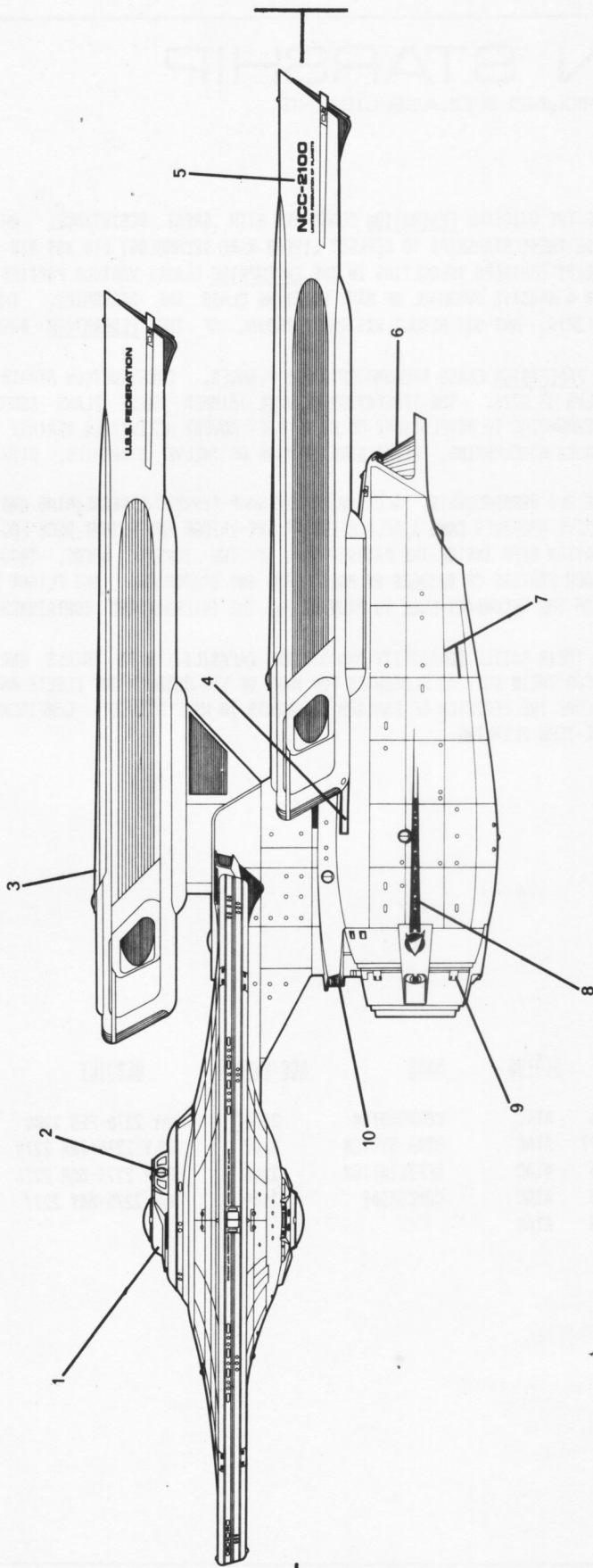

UNITED FEDERATION OF PLANETS
STAR FLEET DIVISION

BUREAU OF OPERATIONS - OFFICE OF RECORDS

GENERAL PLANS
SPACECRAFT CLASS: CLASS ONE STARSHIP OF THE LINE

MODEL: MK-1/02
TYPE: DREADNOUGHT
NOMINAL CLASS: FEDERATION (II)

GENERATED BY: MASTERCOM SFHQ
SCALE: 1:1366

SUBFILE TWO: OUTBOARD PROFILE

RS: 480371+5

TO: 01:04:01:10.12

SPECIFICS:

1. BRIDGE
2. DOCKING PORT-BRIDGE P/S
3. WARP PROPULSION MACELLE-CTR
4. AFT MANEUVERING THRUSTER
5. NUMERICAL I.D.; REGISTRY
6. FLIGHT DECK ACCESS DOORS
7. DEFLECTOR GRID
8. STAR FLEET I.D. PENNANT
9. REACTION CONTROL THRUSTER
10. PHOTO TORPEDO EJECTOR-P/S; F/A





STAR FLEET REFERENCE REPORT

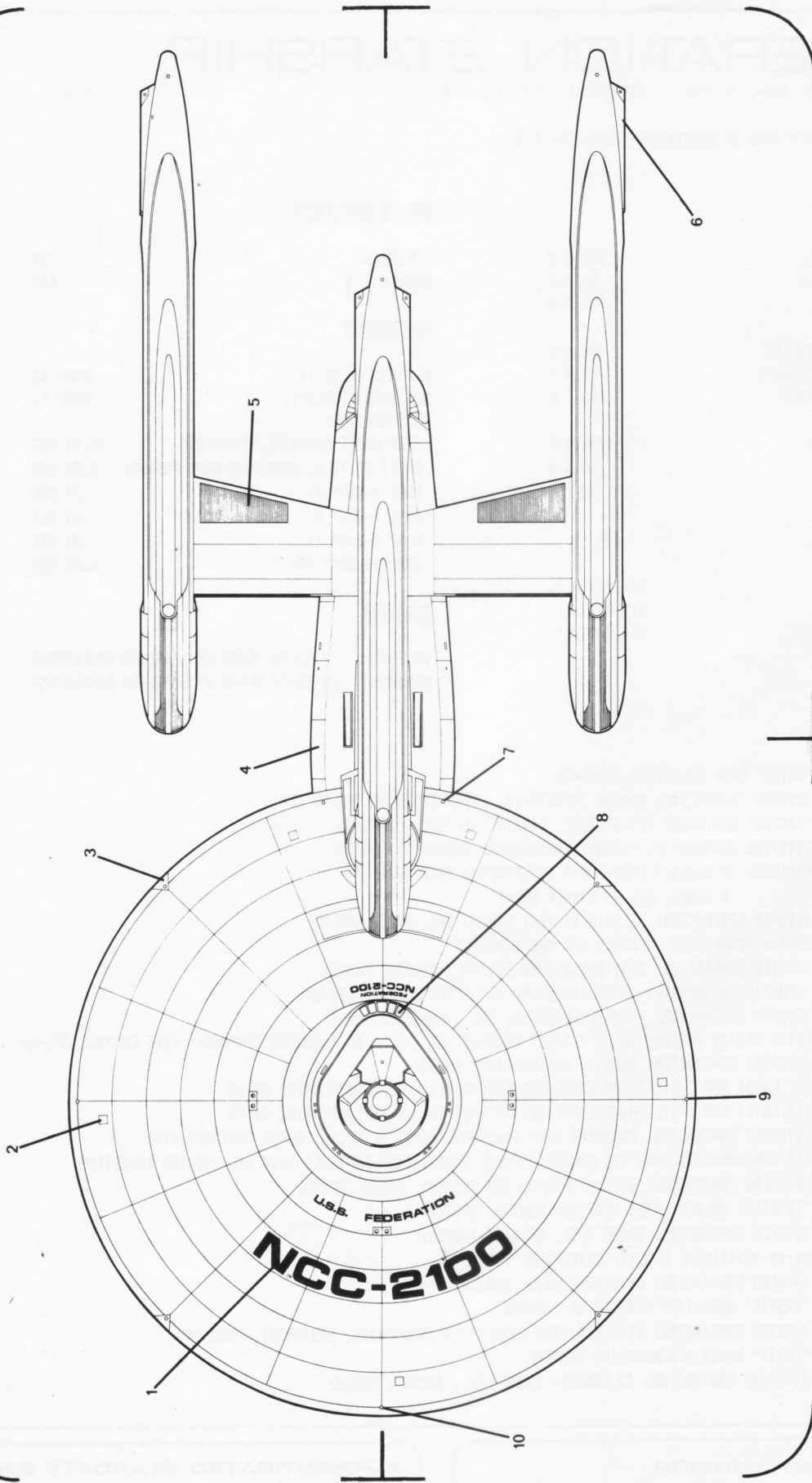

SUBFILE THREE: OUTBOARD TOP VIEW

RS: 480371*5

TO: 01:04:01:10.13

SPECIFICS:

- 1. NOMINAL AND NUMERIC I.D.
- 2. AIRLOCK LIFT HATCH (5)
- 3. REACTION CONTROL THRUSTER
- 4. SECONDARY HULL
- 5. EMERGENCY FLUSH VENT-P/S
- 6. INTERCOOLER
- 7. FORMATION LIGHT-P/S
- 8. OFFICERS' LOUNGE WINDOW
- 9. RUNNING LIGHT T/8; P/S
- 10. BOW LIGHT

UNITED FEDERATION OF PLANETS	
STAR FLEET DIVISION	
BUREAU OF OPERATIONS - OFFICE OF RECORDS	
GENERAL PLANS	SPACECRAFT CLASS: CLASS ONE STARSHIP OF THE LINE
MODEL: MK-1/02	NOMINAL CLASS: FEDERATION (II)
GENERATED BY: MASTERCOM SFHQ	SCALE: 1:1366





FEDERATION STARSHIP

CLASS ONE MK X/02 SPECIFICATIONS

CURRENT SPECIFICATIONS OF FEDERATION (UPRATED) CLASS:

DIMENSIONS

OVERALL LENGTH: 307.6 M
 OVERALL DRAUGHT: 83.7 M
 OVERALL BEAM: 141.7 M

PRIMARY HULL LENGTH: 146.3 M
 PRIMARY HULL DRAUGHT: 32.9 M
 PRIMARY HULL BEAM: 141.7 M

NACELLE LENGTH: 154.8 M
 NACELLE DRAUGHT: 18.3 M
 NACELLE BEAM: 12.6 M

DISPLACEMENT

LIGHT: 272,000 M.T.
 STANDARD: 275,000 M.T.
 FULL LOAD: 276,500 M.T.

SHIP'S COMPLEMENT

OFFICERS: 70
 CREW: 430

PERFORMANCE

MAXIMUM VELOCITY: WARP 15
 CRUISING VELOCITY: WARP 11
 ACCELERATION:
 REST-ONSET CRITICAL MOMENTUM: 10.21 SEC
 ONSET CRITICAL MOMENTUM-WARP ENGAGE: 1.50 SEC
 WARP 1-WARP 4: .71 SEC
 WARP 4-WARP 8: .62 SEC
 WARP 8-WARP 11: .81 SEC
 WARP 11-WARP 15: 4.43 SEC

DURATION

STANDARD: 5 EARTH YEARS AT STANDARD COMPLEMENT
 MAXIMUM: 20 EARTH YEARS AT STANDARD COMPLEMENT

SYSTEMS

NAVIGATION: "ARTOS" WARP CELESTIAL GUIDANCE
 (SYSTEM CONTRACTOR: MANDOR INDUSTRIES, LTD., DALHALAM, DELTA IV)

COMPUTERS: "FASFAX" DUOTRONIC III UPGRADE; DATATAC SUPPORT SUBSYSTEM
 (SYSTEMS CONTRACTOR: FARRANTI MNEMONICS, BERKSHIRE, EARTH)

WEAPONS: PHASERS: 7 BANKS/2 EACH RAR-5 INDEPENDENT TWIN MOUNT
 6 BANKS, RIR 20 SINGLE MOUNT
 (SYSTEM CONTRACTOR: SELENIA SISTEMI S.P.A. INC. ROME, EARTH)
 PHOTON TORPEDOES: 4 BANKS MK7 MOD 1 DIRECT
 (SYSTEM CONTRACTOR: SKAT-RAR WEAPON SYSTEMS, EZURUK, ANDOR)

DEFENSE: "PROMETHEUS" PRIMARY FORCE FIELD AND DEFLECTOR CONTROL SYSTEM
 (SYSTEM CONTRACTOR: PRENTICE-SCHAFFER, INC., MARSPOET, MARS)
 CETIS WEAPON SYSTEM; TACAR (TARGET ACQUISITION CENTER ACCELERATED RESPONSE) FIRE CONTROL ADD-ON
 (SYSTEMS CONTRACTOR: RAAKUV, GAZIWAHAIDA, ANDOR)

PROPULSION: (2) LN-64 MOD 3 DILITHIUM ENERGIZED ANTIMATTER LINEAR WARP DRIVE UNITS
 (1) LN-64 MOD 1 DILITHIUM ENERGIZED ANTIMATTER LINEAR WARP DRIVE UNITS
 (SYSTEMS CONTRACTOR: COCHRANE WARP DYNAMICS, MINOS AL RIJIL, ALPHA CENTAURI VII)
 (2) RSN SUBATOMIC UNIFIED ENERGY IMPULSE UNITS; QASR PARTICLE BEAM MANUEVERING THRUSTERS
 (SYSTEMS CONTRACTOR: SCARBAK PROPULSION SYSTEMS, CAIRO, EARTH)
 "TRENTIS" PULSED LASER REACTION CONTROL SYSTEM
 (SYSTEM CONTRACTOR: ORAGE IJEK, AKSAJAK, ANDOR)

LIFE SUPPORT: MB-4B ARTIFICIAL GRAVITY GENERATOR
 (SYSTEM CONTRACTOR: CRISTOBAL SM/S, MANILA, EARTH)
 "RASTIS" RADIATION PROTECTION PACKAGE
 (SYSTEM CONTRACTOR: TIDJIKJA/ATAR ASSOCIATED INDUSTRIES, RASTARIBI, REGULUS)
 "FEBIX" WASTE REGENERATION SYSTEMS
 (SYSTEMS CONTRACTOR: JULLUNDUR-LAHORE LTD., BOMBAY, EARTH)

RS: 480371.5

TO:01:04:01:10.19

AMENDMENT CODE:OR

AUTHENTICATED STARDATE 8589.76



FEDERATION STARSHIP

CLASS ONE MK X/03 BACKGROUND & CLASS LISTING

BACKGROUND OF ASCENSION CLASS

ON SD 6708.34, THE FEDERATION EXPLORATORY SKIFF WAYFARER DISCOVERED A NUMBER OF EXTRAORDINARY BLACK HOLES IN A DISTANT, PREVIOUSLY UNEXPLORED SECTOR OF SPACE NEAR THE ROMULAN NEUTRAL ZONE (SECTOR 3S 10-A35). INVESTIGATION REVEALED THAT, BECAUSE OF THEIR UNIQUE SHAPE AND SPIN, THE HOLES GREATLY FACILITATED THE ACT OF TRANS-DIMENSIONAL ACCESS, INTEGRAL TO MOVEMENT IN TIME. THE FINDINGS BOTH SHOCKED AND ALARMED THE WAYFARER SCIENTIFIC STAFF, WHO HAD BEEN CONDUCTING RESEARCH ON BLACK HOLE ACCESS, AND HAD NEVER ENCOUNTERED ANYTHING LIKE THE BEHAVIOR THESE OBJECTS EXHIBITED. FURTHER INQUIRY CLEARED AWAY SOME OF THE MYSTERY, HOWEVER. ANCIENT RECORDS FOUND ON A NEARBY PLANET TOLD OF HOW AN ADVANCED, BUT NO LONGER EXTANT CIVILIZATION (NAMED BY THE WAYFARER CHIEF SCIENCES OFFICER THE "TAI SHAN") HAD MANUFACTURED THESE "TIME CONDUITS." AND YET, WHILE DISCOVERY OF THE "TAI SHAN" RECORDS SHED LIGHT ON THE ORIGINS OF THESE OBJECTS, THE PERSISTENT FEAR REMAINED THAT SHOULD THE ROMULANS LEARN OF THEIR SIGNIFICANCE, THEY MIGHT BE TEMPTED TO MOUNT A MAJOR STRIKE TO CAPTURE THE SECTOR.

UNLIKE MEMBERS OF THE KLINGON AND FEDERATION SCIENTIFIC COMMUNITIES, ROMULAN SCIENTISTS HAD NOT YET COME TO AN UNDERSTANDING OF THE DANGER OF TEMPORAL DISPLACEMENT INHERENT IN TIME TRAVEL. STAR FLEET COMMAND THUS CONCLUDED THAT THEY MIGHT BE TEMPTED TO RECOMMEND USING THE BLACK HOLES TO THEIR MILITARY AS A MEANS TO ATTACK ENEMY PLANETS IN AN EARLIER, DEFENSELESS PERIOD. IT THUS BECAME IMPERATIVE TO PROTECT THIS SECTOR AT ALL COSTS, NOT BECAUSE THE ROMULANS COULD SUCCEED IN SUCH AN ATTEMPT, BUT BECAUSE OF THE MASSIVE DAMAGE TO THE STRUCTURE OF SPACE THAT WOULD RESULT FROM THEIR TRYING TO DO SO. UPON RECEIPT OF THE SUBSPACE COMMUNIQUE FROM WAYFARER, THEREFORE, A MAJOR, PERMANENT TASK FORCE WAS ORGANIZED AND DISPATCHED TO THE "TAI SHAN" SECTOR.

THE NUMBER OF CAPITAL SHIPS REQUIRED FOR THIS EFFORT PUT A SIGNIFICANT STRAIN ON THE FLEET. TO TEMPORARILY FILL THE GAP, DREADNOUGHTS, HEAVY CRUISERS, AND OTHER CLASS ONE STARSHIPS IN RESERVE WERE RETURNED TO ACTIVE SERVICE. THIS WAS PERCEIVED AS MERELY A STOPGAP, HOWEVER, SINCE IT WAS OBVIOUS TO ALL CONCERNED THAT THE ADDITION TO THE FLEET'S LIST OF RESPONSIBILITIES DEMANDED THE PROCUREMENT OF NEW SPACECRAFT AS QUICKLY AS POSSIBLE. AS A PART OF THE FLEET EXPANSION PLAN THAT EMERGED AS A RESULT, THE BUREAU OF SPACECRAFT RECOMMENDED THAT 17 OF THE 50 DECATUR/BELKNAP CLASS STRIKE CRUISERS ON ORDER BE MODIFIED TO DREADNOUGHT SPECIFICATIONS. WHILE THIS PART OF THE PLAN WAS ACCEPTED BY BOTH THE OFFICE OF PROCUREMENT AND THE NAVAL CONSTRUCTION CONTRACTS BOARD, SUBSEQUENT SUCCESS IN SPEEDILY UPGRADING FEDERATION CLASS DREADNOUGHTS RESULTED IN A REASSESSMENT OF NEED AND THE DECISION TO LIMIT CONSTRUCTION TO 10 DECATUR/BELKNAP DERIVED DREADNOUGHTS.

THE FIRST SUCH STARSHIP COMPLETED WAS ASCENSION (NCC-2520), WHICH WAS COMMISSIONED IN JUNE 2278. THE OTHER SHIPS OF THIS CLASS FOLLOWED WITHIN THE EXTREMELY SHORT PERIOD OF FOUR EARTH-YEARS. THIS BRIEF SPAN WAS LARGELY A CONSEQUENCE OF EXTENSIVE TRIALS CARRIED OUT ON BOTH DECATUR AND BELKNAP. MANY OF THE PROBLEMS THAT WOULD NORMALLY HAVE PLAGUED THE BUILDING OF A NEW CLASS OF STARSHIPS HAD IN THIS CASE ALREADY BEEN WORKED OUT ON THE STRIKE CRUISER THAT FORMED THE FOUNDATION FOR THIS DREADNOUGHT DESIGN. THIS WAS AS STAR FLEET HAD HOPED, FOR THE RAPID COMMISSIONING OF THESE STARSHIPS HELPED ALLEVIATE THE STRAIN MANY OF THE SUBQUADRANT FLEETS WERE SUFFERING. HEAVY CRUISERS, SHUTTLECARRIERS, AND OLDER DREADNOUGHTS THAT HAD BEEN PRESSED INTO SERVICE AS FLAGSHIPS WERE THUS ALLOWED TO RETURN TO OTHER TASKS FOR WHICH THEY WERE BETTER SUITED. AN UNEXPECTED BENEFIT OF THE SHORT COMPLETION TIME RESULTED FROM THE SURPRISING QUALITY OF ASCENSION CLASS DREADNOUGHTS, ALL OF WHICH HAVE SURPASSED THEIR PREDICTED PERFORMANCE RATINGS BY CONSIDERABLE MARGINS. THUS, NOT ONLY HAS A SERIOUS STRATEGIC GAP BEEN FILLED, BUT IN THE PROCESS, THE QUALITY OF THE FLEET HAS BEEN ENHANCED.

CLASS LISTING OF ASCENSION CLASS:

NAME	NCC NUMBER	COMMISSIONED	STATUS	NAME	NCC NUMBER	COMMISSIONED	STATUS
ASCENSION	2520	02 JUNE 2278	ATAC	MINSK	2525	02 JAN 2280	A0
LEANDER	2521	21 NOV 2278	A0	HIRYU	2526	SD 8123.74	A0
NASHUA	2522	SD 8034.46	A0	CAPODANNO	2527	SD 7999.32	A1S
SUSSEX	2523	SD 7701.84	A3S	TEMPERANCE	2528	15 JULY 2282	ATAC
TAI SHAN	2524	15 AUG 2279	ATAC	REPULSE	2529	SD 7427.15	A2S

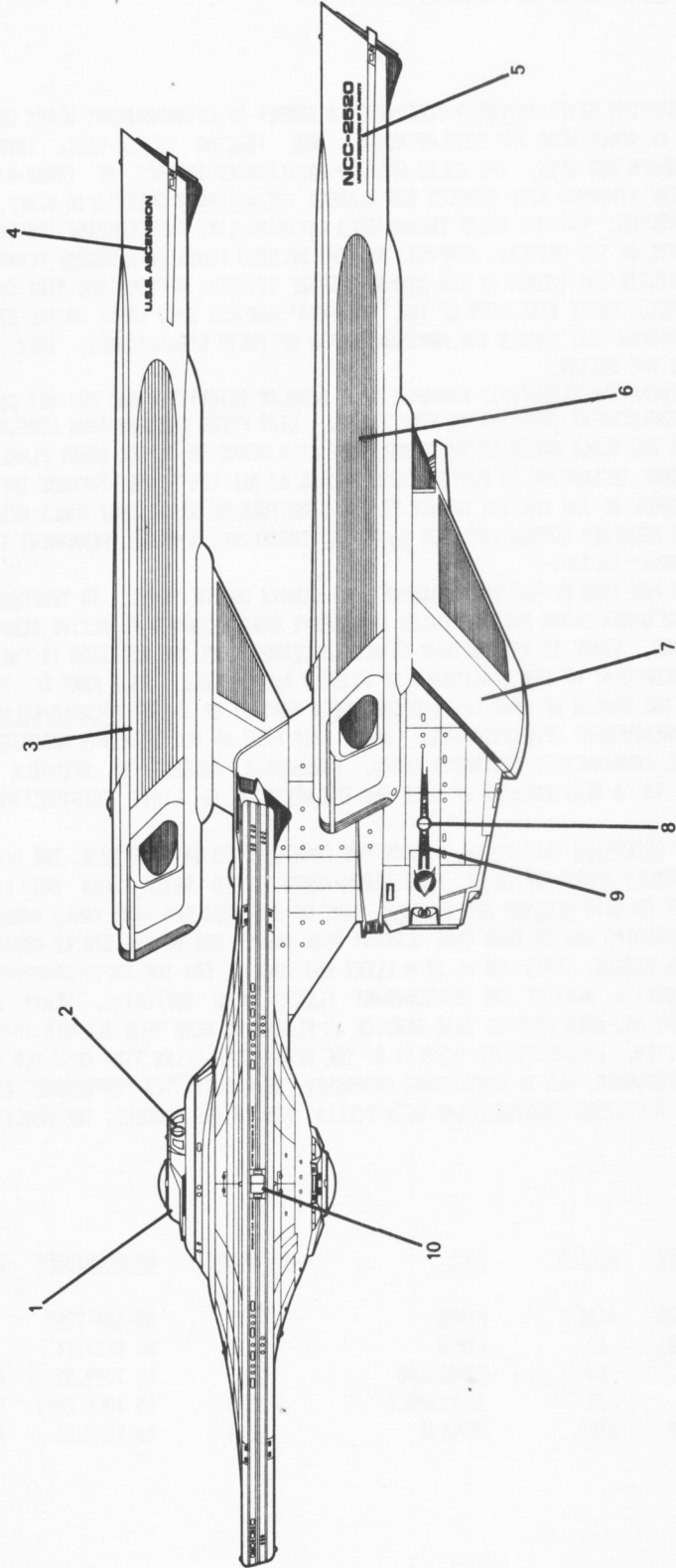

UNITED FEDERATION OF PLANETS
STAR FLEET DIVISION
BUREAU OF OPERATIONS - OFFICE OF RECORDS

GENERAL PLANS		SPACECRAFT CLASS: CLASS ONE STARSHIP OF THE LINE
MODEL: MK-X/03	TYPE: DREADNOUGHT	NOMINAL CLASS: ASCENSION
GENERATED BY: MASTERCOM SFHG		SCALE: 1:1366

SUBFILE TWO: OUTBOARD PROFILE

- TO: 01:04:01:10.22
RS: 480371-3
- SPECIFICS:
1. BRIDGE
 2. DOCKING PORT-BRIDGE P/S
 3. HARP PROPULSION NACELLE-CTR
 4. NOMINAL I.D.
 5. NUMERICAL I.D.; REGISTRY
 6. OUTBOARD FLUX CHILLER
 7. NACELLE SUPPORT PYLON
 8. DOCKING PORT-ENGINEERING P/S
 9. STAR FLEET I.D. PENNANT
 10. MAIN GANGWAY HATCH





STAR FLEET REFERENCE REPORT

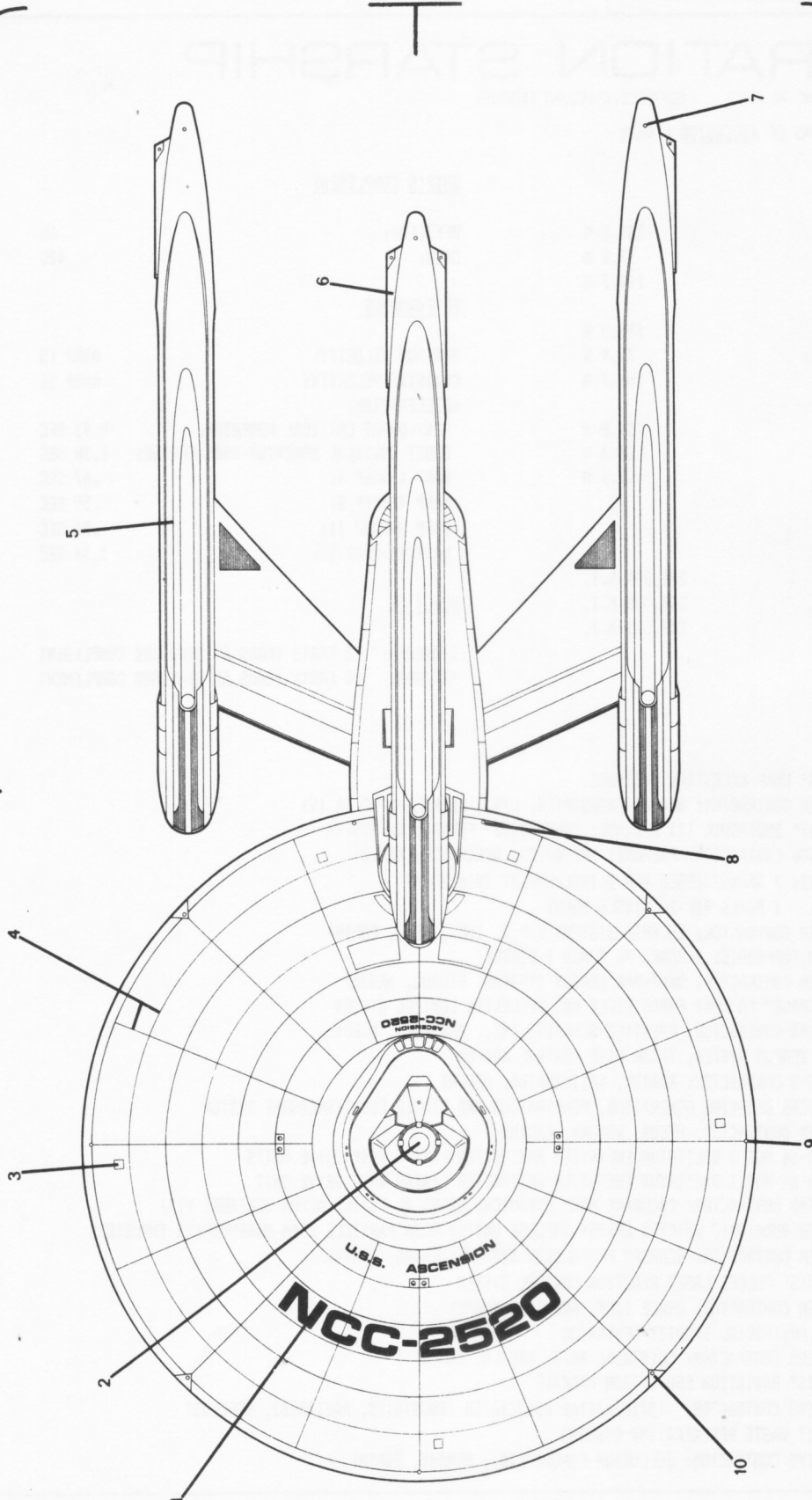

SUBFILE THREE: OUTBOARD TOP VIEW

RS: 480371-3

TO: 01:04:01:10.23

SPECIFICS:

- 1. NOMINAL & NUMERIC I.D.
- 2. NAVIGATIONAL DOME-T/B
- 3. AIRLOCK LIFT HATCH (5)
- 4. DEFLECTOR GRID
- 5. WARP PROPULSION NACELLE-P/S
- 6. INTERCOOLER
- 7. NAVIGATION LIGHT-P/S
- 8. FORMATION LIGHT-P/S
- 9. RUNNING LIGHT-T/B, P/S
- 10. REACTION CONTROL THRUSTER

UNITED FEDERATION OF PLANETS
STAR FLEET DIVISION
 BUREAU OF OPERATIONS - OFFICE OF RECORDS

GENERAL PLANS	SPACECRAFT CLASS:	CLASS ONE STARSHIP OF THE LINE
MODEL: MK-Y/03	TYPE: DREADNOUGHT	NOMINAL CLASS: ASCENSION
GENERATED BY: MASTERCOM SFHG	SCALE: 1:1366	





FEDERATION STARSHIP

CLASS ONE MK X/03 SPECIFICATIONS

CURRENT SPECIFICATIONS OF ASCENSION CLASS:

DIMENSIONS

OVERALL LENGTH: 289.8 M
 OVERALL DRAUGHT: 77.8 M
 OVERALL BEAM: 141.7 M

PRIMARY HULL LENGTH: 146.3 M
 PRIMARY HULL DRAUGHT: 32.9 M
 PRIMARY HULL BEAM: 141.7 M

NACELLE LENGTH: 154.8 M
 NACELLE DRAUGHT: 18.3 M
 NACELLE BEAM: 12.6 M

DISPLACEMENT

LIGHT: 241,000 M.T.
 STANDARD: 245,000 M.T.
 FULL LOAD: 247,500 M.T.

SHIP'S COMPLEMENT

OFFICERS: 65
 CREW: 420

PERFORMANCE

MAXIMUM VELOCITY: WARP 15
 CRUISING VELOCITY: WARP 11
 ACCELERATION:
 REST-ONSET CRITICAL MOMENTUM: 9.93 SEC
 ONSET CRITICAL MOMENTUM-WARP ENGAGE: 1.38 SEC
 WARP 1-WARP 4: .67 SEC
 WARP 4-WARP 8: .59 SEC
 WARP 8-WARP 11: .81 SEC
 WARP 11-WARP 15: 3.34 SEC

DURATION

STANDARD: 5 EARTH YEARS AT STANDARD COMPLEMENT
 MAXIMUM: 20 EARTH YEARS AT STANDARD COMPLEMENT

SYSTEMS

NAVIGATION: "ARTOS" WARP CELESTIAL GUIDANCE
 (SYSTEM CONTRACTOR: MANDOR INDUSTRIES, LTD., DALHALAM, DELTA IV)

COMPUTERS: "FASFAX" DUOTRONIC III UPGRADE; "MNEMOSYNE" FOUNDATION SYSTEM
 (SYSTEMS CONTRACTOR: FARRANTI MNEMONICS, BERKSHIRE, EARTH)

WEAPONS: PHASERS: 7 BANKS/2 EACH RAR-5 INDEPENDENT TWIN MOUNT
 4 BANKS RIR-24 SINGLE MOUNT
 (SYSTEM CONTRACTOR: SELENIA SISTEMI S.P.A. INC., ROME, EARTH)
 PHOTON TORPEDOES: 2 BANKS MK 7 MOD 1 DIRECT
 (SYSTEM CONTRACTOR: SKAT-RAR WEAPON SYSTEMS, EZURUK, ANDOR)

DEFENSE: "PERCIVALE" PRIMARY FORCE FIELD AND DEFLECTOR CONTROL SYSTEM
 (SYSTEMS CONTRACTOR: PRENTICE-SCHAFFER, INC., MARSPORT, MARS)
 CETIS WEAPON SYSTEM, TACAR FIRE CONTROL ADD-ON
 (SYSTEMS CONTRACTOR: RAAKUV, GAZIWAHAIDA, ANDOR)
 CGCP/SCDS CLOAKING GENERATION, PENETRATION AND STASIS COUNTERMEASURE SYSTEM
 (SYSTEM CONTRACTOR: HYCOR, WOBURN, EARTH)

PROPULSION: (2) LN-64 MOD 3 DILITHIUM ENERGIZED ANTIMATTER LINEAR WARP DRIVE UNITS
 (1) LN-64 MOD 1 DILITHIUM ENERGIZED ANTIMATTER LINEAR WARP DRIVE UNIT
 (SYSTEMS CONTRACTOR: COCHRANE WARP DYNAMICS, MINOS AL RIJIL, ALPHA CENTAURI VII)
 (2) RSN SUBATOMIC UNIFIED ENERGY IMPULSE UNITS; GASR PARTICLE BEAM MANEUVERING THRUSTERS
 (SYSTEM CONTRACTOR: SCARBAK PROPULSION SYSTEMS, CAIRO, EARTH)
 "TRENTIS" PULSED LASER REACTION CONTROL SYSTEM
 (SYSTEM CONTRACTOR: DRAGE IJEK, AKSAJAK, ANDOR)

LIFE SUPPORT: MB-41 ARTIFICIAL GRAVITY GENERATOR
 (SYSTEMS CONTRACTOR: CRISTOBAL SM/S, MANILA, EARTH)
 "RASTIS" RADIATION PROTECTION PACKAGE
 (SYSTEMS CONTRACTOR: TIDJIKJA/ATAR ASSOCIATED INDUSTRIES, RASTARIBI, REGULUS)
 "CERIX" WASTE REGENERATION SYSTEMS
 (SYSTEMS CONTRACTOR: JULLUNDUR-LAHORE LTD., BOMBAY, EARTH)

RS: 480371.3

TO:01:04:01:10.29

AMENDMENT CODE:OR

AUTHENTICATED STARDATE 8675.09



FEDERATION STARSHIP

CLASS ONE MK XI/01 BACKGROUND & CLASS LISTING

BACKGROUND OF AVENGER CLASS:

THE 22 AVENGER CLASS HEAVY FRIGATES WERE REBUILT FROM STARSHIPS OF THE SURYA CLASS, CONSTRUCTED SOME 25-30 EARTH YEARS AGO. ORIGINALLY DESIGNED TO PROVIDE AN AFFORDABLE DETERRENT TO ROMULAN INCURSIONS ACROSS THE NEUTRAL ZONE, SURYA CLASS FRIGATES RESEMBLED PTOLEMY CLASS TRANSPORTS, BUT POSSESSED FAR GREATER FIREPOWER. WITH THE PEACEFUL YEARS OF THE LATE 2260'S, MUCH OF THIS FRIGATE FORCE WAS PLACED ON RESERVE STATUS. HOWEVER, IN 2272 FORCES OF THE KZIN ATTACKED TAU CETI, AND DURING THE BRIEF BUT ACUTE PERIOD OF TENSION WHICH FOLLOWED IT BECAME PAINFULLY OBVIOUS THAT STAR FLEET WAS IN DESPERATE NEED OF FRIGATES MORE VERSATILE AND POWERFUL THAN THE EXISTING SURYA AND COVENTRY CLASSES. IT WAS IN RESPONSE TO THIS NEED THAT 22 SURYA CLASS FRIGATES WERE SENT INTO DRYDOCK FOR REBUILDING.

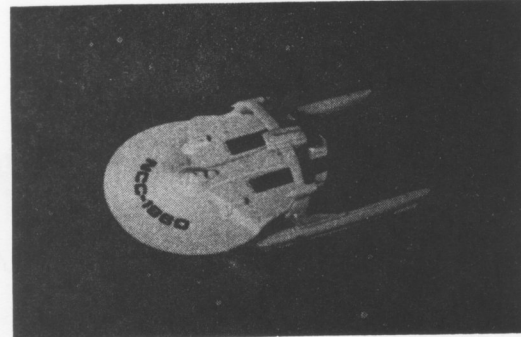

U.S.S. AVENGER (NCC-1860) DURING TRIALS

DESIGN CHANGES INCLUDED THE ADDITION OF MEGAPHASER CANNONS, THE POWERFUL WEAPONS DEVELOPED IN THE COURSE OF MASS INVERSION RESEARCH. THE STARSHIPS WERE ALSO EACH EQUIPPED WITH A FORE AND AFT PHOTON TORPEDO FIRING SYSTEM, DETACHED FROM THE PRIMARY HULL AND YET STILL DIRECT IN OPERATION (ACQUIRING ANTIMATTER FROM THE MAIN ENGINE STORES). FINALLY, THE RESULTING DESIGN UTILIZED ADVANCES IN WARP DYNAMICS AND PROPULSION TECHNOLOGY FIRST USED ON ENTERPRISE CLASS HEAVY CRUISERS. THE NEW LN-64 WARP DRIVE UNITS WERE LINKED TO THE MEGAPHASER CANNONS BY MEANS OF SUPPORT PYLONS HOUSING LINEAR FEED CHAMBERS. THE RESULTING WEAPONS/PROPULSION PACKAGE CAN BE DISENGAGED IN WHOLE OR PART FROM THE PRIMARY HULL SHOULD THE NEED ARISE.

DESIGNATED "HEAVY" FRIGATES BECAUSE OF THEIR ADDED DISPLACEMENT AND ARMAMENT, THE NEW CLASS WAS NAMED AFTER AVENGER, THE FIRST OF THE SURYA CLASS FRIGATES FOR WHICH REBUILDING WAS AUTHORIZED. BLENDING DESIGN FEATURES OF THE FEDERATION CLASS DREADNOUGHT AND THE ARIEL CLASS SHUTTLECARRIER, THESE STARSHIPS ARE INCREDIBLY VERSATILE, AND CAN ACT AS EITHER MODERATE CAPACITY BASES FOR FIGHTERCRAFT OPERATIONS OR BATTLECRUISER EQUIVALENTS. AND YET, IN TIMES OF REDUCED TENSION THE LARGE FORCE PROVED TO BE AN EXPENSIVE BURDEN TO A FLEET DESIGNED PRIMARILY FOR EXPLORATION AND COLONIZATION. A LARGE NUMBER OF AVENGER CLASS HEAVY FRIGATES WERE THEREFORE MODIFIED DURING RECENT OVERHAULS SO THAT THEY MIGHT BETTER FULFILL THEIR ROLE AS VANGUARDS ON THE FRONTIER OF COSMIC DISCOVERY.

CLASS LISTING OF AVENGER CLASS:

NAME	NCC NUMBER	REBUILT	STATUS	NAME	NCC NUMBER	REBUILT	STATUS
AVENGER	1860	MAR 2273-MAY 2274	A2S	DARDANIUS	1871	MAY 2273-SEP 2274	A2S
COURAGEOUS	1861	JAN 2276-MAR 2277	RDF	HIPPOLYTA	1872	SD 7307.84-7410.17	ATC3N
ENDURANCE	1862	FEB 2274-APR 2275	A2N	MELKOTIA	1873	DEC 2273-MAR 2275	A4S
ILLUSTRIOUS	1863	SD 7403.20-7505.66	SRF	SARPEIDON	1874	JAN 2276-MAR 2277	SR0
RELIANT	1864	APR 2273-JUNE 2274	D	ODIN	1875	SD 7602.01-7704.50	SR2N
VIGILANT	1865	APR 2273-JUNE 2274	ATC2S	NAR-TAK SHIR	1876	SEP 2274-NOV 2275	ATC2S
DROMIO	1866	SD 7305.24-7407.12	A1S	RESOLUTION	1877	SD 7410.37-7512.64	A3S
BALTHASAR	1867	MAY 2275-JUL 2276	A3S	POLONIUS	1878	SD 7411.13-7601.28	ATC2S
ARDANA	1868	JUL 2275-OCT 2276	SR2S	YONADA	1879	JUN 2274-AUG 2275	A4N
AMIENS	1869	SD 7508.91-7611.34	A1N	OSBERON	1880	SD 7407.84-7509.12	A3N
ANTIPHOLUS	1870	SD 7598.31-7699.21	A3N	ALACRITY	1881	JAN 2275-MAR 2276	A0

RS: 480371.1

TO: 01:04:01:11.01

AUTHENTICATED STARDATE 8408.29

AMENDMENT CODE:OR

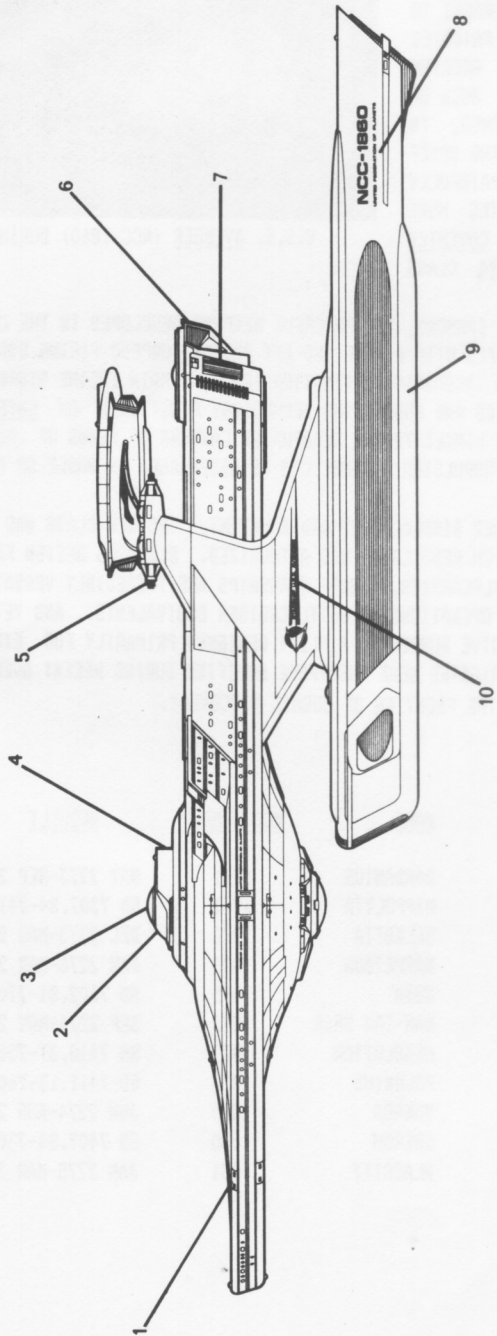

SUBFILE TWO: OUTBOARD PROFILE

- RS: 480371-1
- TO: 01:04:01:11.02
- SPECIFICS:
1. REACTION CONTROL THRUSTER
 2. BRIDGE
 3. NAVIGATIONAL DOME-T/B
 4. DOCKING PORT-BRIDGE
 5. MEGAPHASER (4)-2 EACH P/S
 6. IMPULSE PROPULSION HOUSING
 7. FLIGHT DECK ACCESS DOORS-P/S
 8. NUMERICAL I.D.; REGISTRY
 9. WARP PROPULSION NACELLE-P/S
 10. STAR FLEET I.D. PENNANT

UNITED FEDERATION OF PLANETS
STAR FLEET DIVISION
BUREAU OF OPERATIONS - OFFICE OF RECORDS

GENERAL PLANS	SPACECRAFT CLASS: CLASS ONE STARSHIP OF THE LINE
MODEL: MK-XI/01	NOMINAL CLASS: HEAVY FRIGATE AVENGER
GENERATED BY: MASTERCOM SFHQ	SCALE: 1:1366





STAR FLEET REFERENCE REPORT

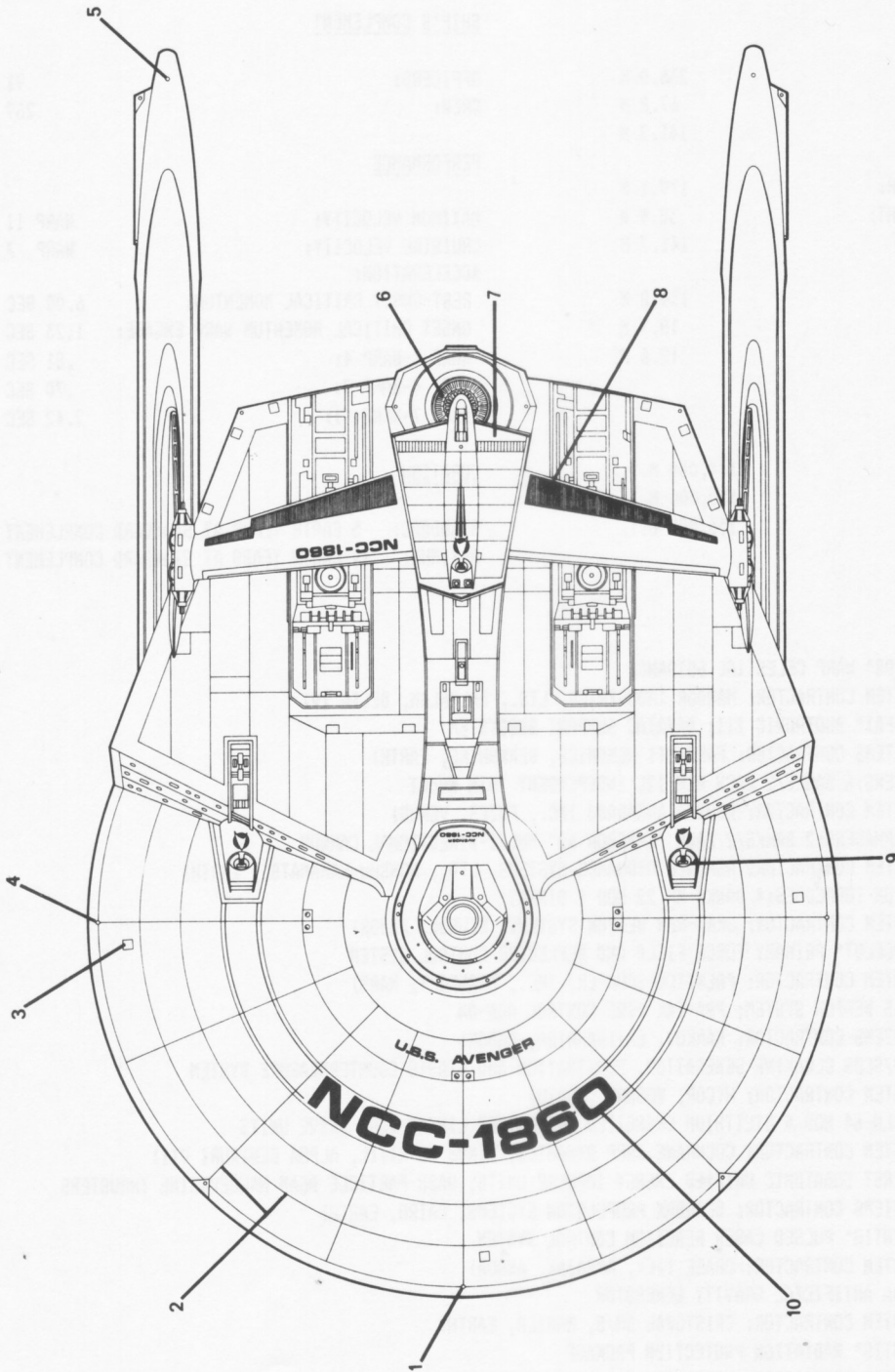

SUBFILE THREE: OUTBOARD TOP VIEW

RS:480371-1

TO:01:04:01:11.03

SPECIFICS:

1. BOW LIGHT	6. IMPULSE DEFLECTION CRYSTAL
2. DEFLECTOR GRID	7. PHOTON WEAPONS POD
3. AIRLOCK LIFT HATCH (9)	8. EMERGENCY FLUSH VENT-P/S
4. RUNNING LIGHT-T/B; P/S	9. SPACE ENERGY FIELD SENSOR-P/S
5. NAVIGATION LIGHT-P/S	10. NOMINAL & NUMERICAL I.D.

UNITED FEDERATION OF PLANETS
STAR FLEET DIVISION
 BUREAU OF OPERATIONS - OFFICE OF RECORDS

GENERAL PLANS		SPACECRAFT CLASS: CLASS ONE STARSHIP OF THE LINE	
MODEL: MK-XI/01	TYPE: HEAVY FRIGATE	NOMINAL CLASS: AVENGER	
GENERATED BY: MASTERCOM SFHG		SCALE:	1:1366





FEDERATION STARSHIP

CLASS ONE MK XI/01 SPECIFICATIONS

CURRENT SPECIFICATIONS OF AVENGER CLASS:

DIMENSIONS

OVERALL LENGTH: 236.0 M
 OVERALL DRAUGHT: 67.8 M
 OVERALL BEAM: 141.7 M

PRIMARY HULL LENGTH: 179.1 M
 PRIMARY HULL DRAUGHT: 32.9 M
 PRIMARY HULL BEAM: 141.7 M

NACELLE LENGTH: 154.8 M
 NACELLE DRAUGHT: 18.3 M
 NACELLE BEAM: 12.6 M

DISPLACEMENT

LIGHT: 144,000 M.T.
 STANDARD: 150,000 M.T.
 FULL LOAD: 156,000 M.T.

SYSTEMS

NAVIGATION: "ARTOS" WARP CELESTIAL GUIDANCE
 (SYSTEM CONTRACTOR: MANDOR INDUSTRIES, LTD., DALHALAM, DELTA IV)

COMPUTERS: "FASFAX" DUOTRONIC III; DATATAC SUPPORT SUBSYSTEM
 (SYSTEMS CONTRACTOR: FARRANTI NEMONICS, BERKSHIRE, EARTH)

WEAPONS: PHASERS: 6 BANKS/2 EACH R1M-12C INDEPENDENT TWIN MOUNT
 (SYSTEM CONTRACTOR: AGUSTA ANSADADO INC., FUZES, VENUS)
 MEGAPHASERS: 2 BANKS/2 EACH "EMPEROR 60" MULTI-DIRECTIONAL CANNON
 (SYSTEM CONTRACTOR: ASAKAZE ORDNANCE SYSTEMS, LTD., HONSHU-HAMAMATSU, EARTH)
 PHOTON TORPEDOES: 4 BANKS MK 22 MOD 1 DIRECT
 (SYSTEM CONTRACTOR: SKAT-RAR WEAPON SYSTEMS, EZURUK, ANDOR)

DEFENSE: "LANCELOT" PRIMARY FORCE FIELD AND DEFLECTOR CONTROL SYSTEM
 (SYSTEM CONTRACTOR: PRENTICE-SCHAFFER, INC., MARSPORT, MARS)
 CETIS WEAPON SYSTEM; PRA-TAK FIRE CONTROL ADD-ON
 (SYSTEMS CONTRACTOR: RAAKUV, GAZIWAHAIDA, ANDOR)
 C6CP/SCDS CLOAKING GENERATION, PENETRATION AND STASIS COUNTERMEASURE SYSTEM
 (SYSTEM CONTRACTOR: HYCOR, WOBURN, EARTH)

PROPULSION: (2) LN-64 MOD 4 DILITHIUM ENERGIZED ANTIMATTER LINEAR WARP DRIVE UNITS
 (SYSTEM CONTRACTOR: COCHRANE WARP DYNAMICS, MINOS AL RIJIL, ALPHA CENTAURI VII)
 (2) RST SUBATOMIC UNIFIED ENERGY IMPULSE UNITS; BASR PARTICLE BEAM MANUEVERING THRUSTERS
 (SYSTEMS CONTRACTOR: SCARBAK PROPULSION SYSTEMS, CAIRO, EARTH)
 "TRENTIS" PULSED LASER REACTION CONTROL SYSTEM
 (SYSTEM CONTRACTOR: ORAGE IJEK, AKSAJAK, ANDOR)

LIFE SUPPORT: MB-4A ARTIFICIAL GRAVITY GENERATOR
 (SYSTEM CONTRACTOR: CRISTOBAL SM/S, MANILA, EARTH)
 "RASTIS" RADIATION PROTECTION PACKAGE
 (SYSTEM CONTRACTOR: TIDJIKJA/ATAR ASSOCIATED INDUSTRIES, RASTARIBI, REGULUS)
 "CERIX" WASTE REGENERATION SYSTEMS
 (SYSTEMS CONTRACTOR: JULLUNDUR-LAHORE LTD., BOMBAY, EARTH)

SHIP'S COMPLEMENT

OFFICERS: 91
 CREW: 269

PERFORMANCE

MAXIMUM VELOCITY: WARP 11
 CRUISING VELOCITY: WARP 7
 ACCELERATION:
 REST-ONSET CRITICAL MOMENTUM: 6.08 SEC
 ONSET CRITICAL MOMENTUM-WARP ENGAGE: 1.23 SEC
 WARP 1-WARP 4: .81 SEC
 WARP 4-WARP 7: .70 SEC
 WARP 7-WARP 11: 2.42 SEC

DURATION

STANDARD: 5 EARTH YEARS AT STANDARD COMPLEMENT
 MAXIMUM: 19 EARTH YEARS AT STANDARD COMPLEMENT

RS: 480371-1

TO: 01:04:01:11.09

AMENDMENT CODE: OR

AUTHENTICATED STARDATE 8408.29



FEDERATION STARSHIP

CLASS ONE MK XII/02 BACKGROUND & CLASS LISTING

BACKGROUND OF MENAHGA CLASS:

THE BRIEF CONFLICT KNOWN AS THE KZNTI INCURSION PROMPTED STAR FLEET COMMAND TO REASSESS ITS STRATEGIC PRIORITIES. TO MANY, THE ATTACKS ON COLONIES IN OUTLYING SECTORS OF FEDERATION SPACE DROVE HOME THE NEED FOR A "BATTLECRUISER" CAPABLE OF MOVING VERY QUICKLY TO A BATTLEZONE, ENGAGING ENEMY UNITS WITHOUT SUPPORT, AND MAINTAINING CONTROL OF THE BATTLEZONE UNTIL SUPPORT CAN ARRIVE. SOME WITHIN THE STAFF OF TECHNICAL ASSISTANTS TO THE CHIEF OF STAR FLEET COMMAND DISPUTED THIS CONTENTION HOWEVER, CLAIMING INSTEAD THAT CONSTRUCTION OF MORE DREADNOUGHTS, OR THE CONTROVERSIAL SPACE CONTROL SHIP, COULD BETTER FILL THE PERCEIVED STRATEGIC GAP.

CONSIDERATIONS OF ECONOMY PERSUADED THE BUREAU OF SPACECRAFT TO RECOMMEND PURSUING THE BATTLECRUISER OPTION. (IT SHOULD BE NOTED, HOWEVER, THAT PROBLEMS WITH THE BATTLECRUISER PROJECT EVENTUALLY LED TO DECISIONS TO PROCEED WITH OTHER OPTIONS AS WELL). IN LATE-2276, THE DESIGN BRANCH OF GENERAL DYNAMICS (STARSHIP DIVISION) PRESENTED WHAT EVENTUALLY EVOLVED INTO THE MENAHGA DESIGN. OPPONENTS TO THE BATTLECRUISER OPTION WERE NOW JOINED BY CRITICS OF THE SPECIFIC DESIGN PROPOSAL, AND FOR OVER ONE EARTH-YEAR THE PROJECT WAS DELAYED WHILE CONTROVERSY RAGED ON (SEE FSHYNDA FA'A'AREN, "STAR FLEET'S...BATTLECRUISER?" STARSHIP DESIGN, XXXIV, 1, 2280.). IN JANUARY 2278, CHIEF OF STAR FLEET COMMAND HIERACHIRO NOGURA ENDED THE DISPUTE FOR THE MOMENT WHEN HE ORDERED THAT THE CONSTRUCTION OF MENAHGA BEGIN. WITHIN TWENTY MONTHS, THE BATTLECRUISER WAS LAUNCHED. SUBSEQUENT TRIALS SUBSTANTIATED SOME OF THE DESIGN CRITICS' CLAIMS, HOWEVER, RESULTING IN ANOTHER TWENTY MONTHS DELAY WHILE NUMEROUS FLAWS IN THE PHOTON TORPEDO, PHASER CONTROL, AND WARP PROPULSION MATTER ACQUISITION SYSTEMS WERE CORRECTED.

MEANWHILE, CONSTRUCTION BEGAN ON TWO ADDITIONAL MENAHGA CLASS BATTLECRUISERS, INCORPORATING THE SYSTEMS MODIFICATIONS DEVELOPED FOR THE CLASS VESSEL. TWO ADDITIONAL SHIPS WERE ORDERED, AND FIVE MORE WERE PLANNED FOR EVENTUAL CONSTRUCTION (FOR A TOTAL OF TEN). HOWEVER, THE DEVELOPMENT OF A SUBTLY IMPROVED BATTLECRUISER DESIGN LED TO A CHANGE IN PLANS, WITH THE SEVEN UNBUILT MENAHGA CLASS STARSHIPS FORMING THE NEW MITANNIC CLASS. AT THE SAME TIME, SHIPS OF THE MENAHGA CLASS WERE REDESIGNATED "HEAVY DESTROYERS," A MOVE THAT WAS MET WITH RIDICULE BY THOSE WHO HAD CLAIMED ALL ALONG THAT MENAHGA DID NOT MEET BATTLECRUISER SPECIFICATIONS.

AT THE PRESENT TIME, MENAHGA CLASS STARSHIPS (LIKE THOSE OF THE MITANNIC CLASS) ARE DEPLOYED AT THE MOST DISTANT (AND VULNERABLE) STAR BASES AND OUTPOSTS. AS SHORT DURATION SPACECRAFT, THEY ARE MAINTAINED AT A CONDITION OF CONSTANT STANDBY READINESS, AND IN THIS STATE NEVER HAVE MORE THAN 40 CREW MEMBERS (ON ROTATION FROM THE MAIN CREW) ABOARD. AND YET, AT THE LEAST SIGN OF TROUBLE, THE FULL COMPLEMENT CAN BE TRANSPORTED ABOARD FOR IMMEDIATE ACTION.

THUS FAR, THESE STARSHIPS HAVE FILLED THEIR LIMITED ROLES ADMIRABLY. THE FUTURE OF THE BATTLECRUISER/HEAVY DESTROYER OPTION, THEREFORE, RESTS LARGELY WITH THE FUTURE SUCCESS OR FAILURE OF THE EXCELSIOR CLASS SPACE CONTROL SHIP. STAR FLEET REALIZES IT CANNOT FOLLOW BOTH COURSES, AND GIVEN THE PROBLEMS EACH PROJECT HAS ENCOUNTERED, THE FINAL DECISION MAY WELL BE THAT A THIRD CHOICE, REFLECTING A SYNTHESIS OF BATTLECRUISER/HEAVY DESTROYER AND SPACE CONTROL SHIP, WILL BE ADOPTED.

CLASS LISTING OF MENAHGA CLASS :

NAME	NCC NUMBER	COMMISSIONED	STATUS
MENAHGA	3100	SD 8103.23	A3S
ARSUF	3101	SD 8301.04	A3S
KORYAK	3102	SD 8307.96	A2S

MENAHGA CLASS STARSHIPS ORDERED BUT BUILT AS MITANNIC CLASS BATTLECRUISERS: MITANNIC, HASTINGS, MARATHON, PASHTQ, AVENDESTA, AUSTERLITZ, ZETAR.

RS: 480371.3

TO: 01:04:01:12.11

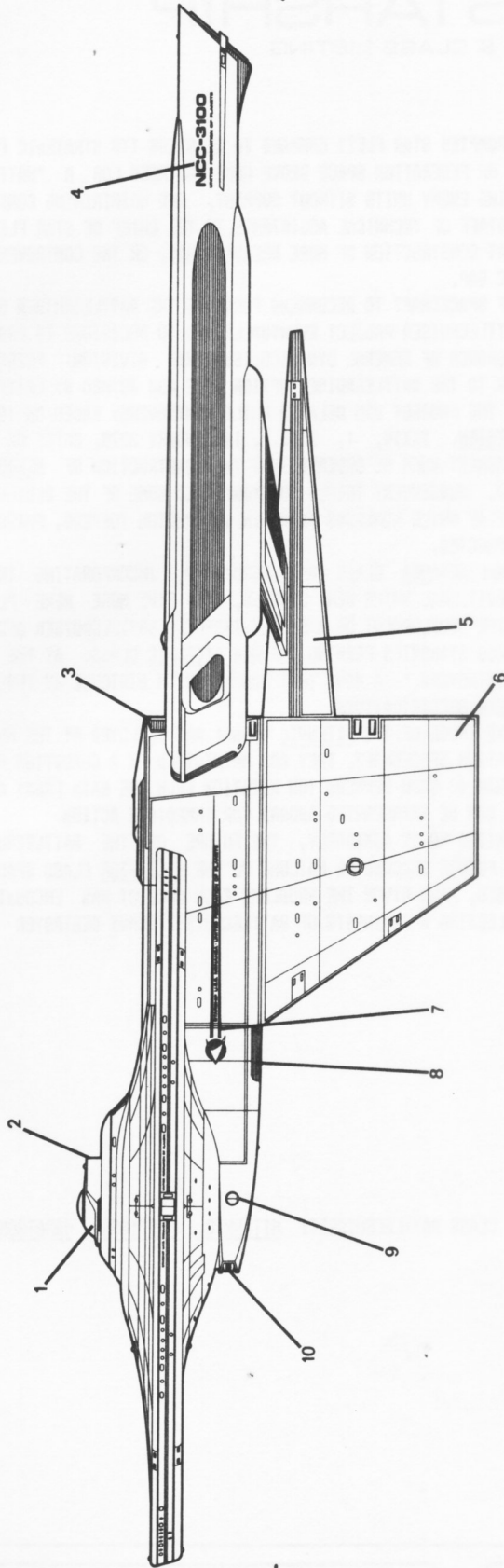

SUBFILE TWO: OUTBOARD PROFILE

RS: 480371-3

TO: 01:04:01:12.12

SPECIFICS:

- 1. BRIDGE
- 2. DOCKING PORT-BRIDGE
- 3. IMPULSE PROPULSION HOUSING
- 4. NUMERICAL I.D.; REGISTRY
- 5. WARP DRIVE SUPPORT HULL
- 6. SECONDARY HULL
- 7. STAR FLEET I.D. PENNANT
- 8. PHOTON WEAPONS EXHAUST VENT
- 9. DOCKING PORT-TORPEDO BAY
- 10. PHOTON TORPEDO EJECTOR-P/S

UNITED FEDERATION OF PLANETS
STAR FLEET DIVISION
 BUREAU OF OPERATIONS - OFFICE OF RECORDS

GENERAL PLANS	SPACECRAFT CLASS: CLASS ONE STARSHIP OF THE LINE
MODEL: HK-X11/02	NOMINAL CLASS: HEAVY DESTROYER MENAHGA
GENERATED BY: MASTERCOM SFHG	SCALE: 1:1366





STAR FLEET REFERENCE REPORT

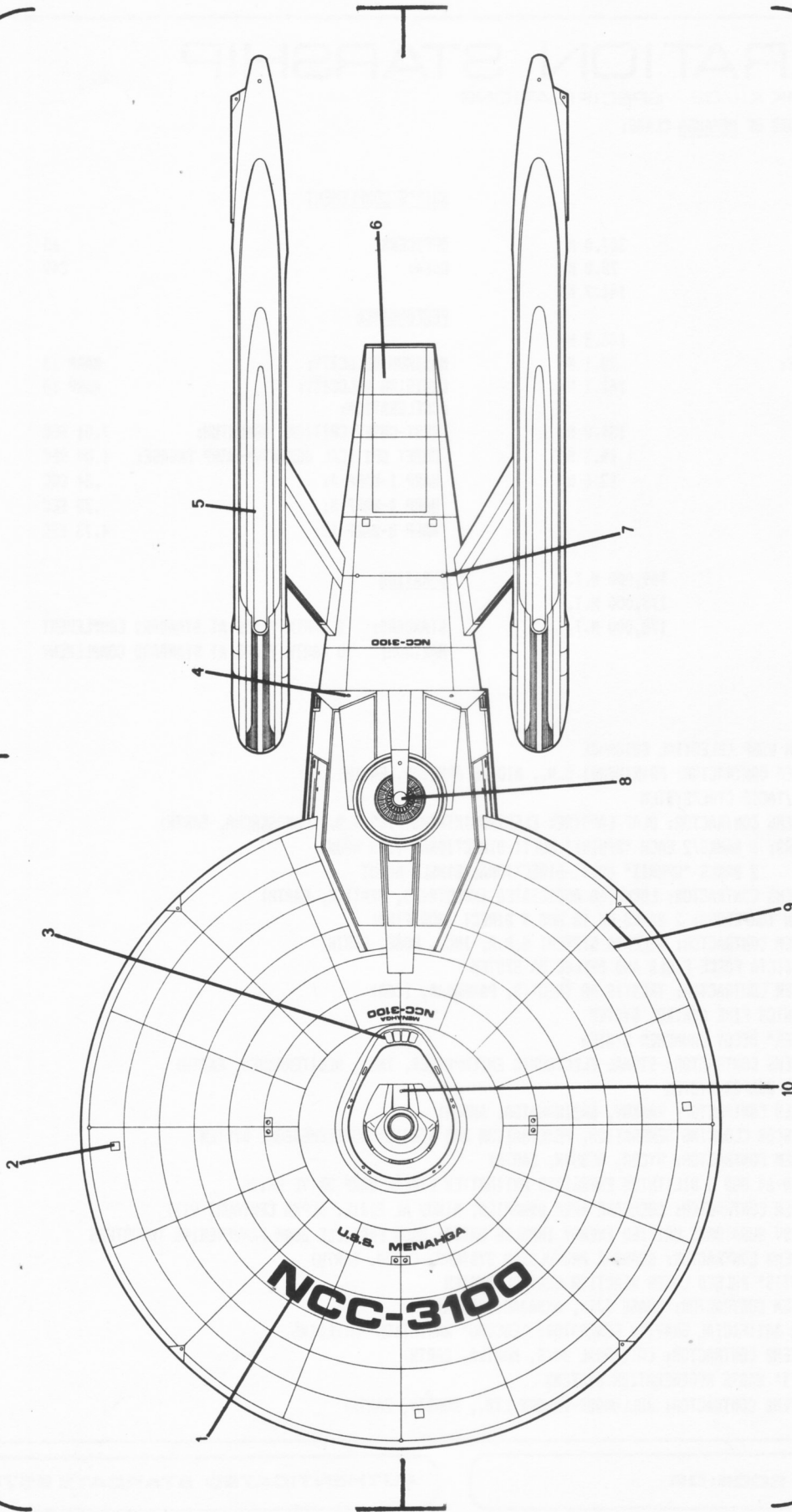

SUBFILE THREE: OUTBOARD TOP VIEW

RG:480371-3

TO:01:04:01:12.13

SPECIFICS:

1. NOMINAL & NUMERICAL I.D.
2. AIRLOCK LIFT HATCH (5)
3. OFFICERS' LOUNGE WINDOWS
4. AFT PHASER TURRET-P/S
5. WARP PROPULSION NACELLE-P/S
6. BLOW-AWAY PANELS
7. FORMATION LIGHT-P/S
8. IMPULSE DEFLECTION CRYSTAL
9. DEFLECTOR GRID
10. NAVIGATION LIGHT

UNITED FEDERATION OF PLANETS	
BUREAU OF OPERATIONS - OFFICE OF RECORDS	
GENERAL PLANS	SPACECRAFT CLASS: CLASS ONE STARSHIP OF THE LINE
MODEL: MK-X11/02	NOMINAL CLASS: HEAVY DESTROYER MENANGA
GENERATED BY: MASTERCOM SFHQ	SCALE: 1:1366





FEDERATION STARSHIP

CLASS ONE MK XII/02 SPECIFICATIONS

CURRENT SPECIFICATIONS OF MENAHGA CLASS:

DIMENSIONS

OVERALL LENGTH: 307.0 M
 OVERALL DRAUGHT: 78.0 M
 OVERALL BEAM: 141.7 M

PRIMARY HULL LENGTH: 146.3 M
 PRIMARY HULL DRAUGHT: 28.1 M
 PRIMARY HULL BEAM: 141.7 M

MACELLE LENGTH: 154.8 M
 MACELLE DRAUGHT: 18.3 M
 MACELLE BEAM: 12.6 M

DISPLACEMENT

LIGHT: 169,000 M.T.
 STANDARD: 173,000 M.T.
 FULL LOAD: 178,000 M.T.

SHIP'S COMPLEMENT

OFFICERS: 65
 CREW: 240

PERFORMANCE

MAXIMUM VELOCITY: WARP 13
 CRUISING VELOCITY: WARP 10
 ACCELERATION:
 REST-ONSET CRITICAL MOMENTUM: 7.01 SEC
 ONSET CRITICAL MOMENTUM-WARP ENGAGE: 1.04 SEC
 WARP 1-WARP 4: .84 SEC
 WARP 4-WARP 8: .78 SEC
 WARP 8-WARP 13: 4.73 SEC

DURATION

STANDARD: 2 EARTH YEARS AT STANDARD COMPLEMENT
 MAXIMUM: 10 EARTH YEARS AT STANDARD COMPLEMENT

SYSTEMS

NAVIGATION: NAVRAM WARP CELESTIAL GUIDANCE
 (SYSTEM CONTRACTOR: PRINZHENRI S.N., RIO DE JANEIRO, EARTH)

COMPUTERS: STRAT/TACCS CYBERSYSTEM
 (SYSTEMS CONTRACTOR: DLAF LAPSTREK ELECTRONIKINDUSTRIER A.B., LANDSKRONA, EARTH)

WEAPONS: PHASERS: 6 BANKS/2 EACH "SPHINX" MULTI-DIRECTIONAL TWIN MOUNT
 2 BANKS "SPHINX" MULTI-DIRECTIONAL SINGLE MOUNT
 (SYSTEMS CONTRACTOR: LOCKHEED ASSOCIATED INDUSTRIES, SEATTLE, EARTH)
 PHOTON TORPEDOES: 2 BANKS MK 18 MOD 3 DIRECT (MODIFIED)
 (SYSTEM CONTRACTOR: SELENIA SISTEMI S.P.A. INC., ROME, EARTH)

DEFENSE: RSAT/JICTA FORCE FIELD AND DEFLECTOR SYSTEM
 (SYSTEM CONTRACTOR: TRESTIS AR TRESTIS, PANGAEAR, IZAR)
 OPTRONICS FIRE CONTROL SYSTEM
 "DAGGER" DECOY LAUNCHER SYSTEM
 (SYSTEMS CONTRACTOR: SIGNAL ELECTRONIC ENTERPRISES, INC., MEDITERRANEA, EARTH)
 GARTAS WEAPON SYSTEM
 (SYSTEM CONTRACTOR: RAAKUV, GAZIMAHADA, ANDOR)
 CGCP/SCDS CLOAKING GENERATION, PENETRATION AND STASIS COUNTERMEASURE SYSTEM
 (SYSTEM CONTRACTOR: HYCOR, WOBURN, EARTH)

PROPULSION: (2) LN-64 MOD 3 DILITHIUM ENERGIZED ANTIMATTER LINEAR WARP DRIVE UNITS
 (SYSTEM CONTRACTOR: COCHRANE WARP DYNAMICS, MINOS AL RIJIL, ALPHA CENTAURI VII)
 (2) RSV SUBATOMIC UNIFIED ENERGY IMPULSE UNITS; QASR PARTICLE BEAM MANUEVERING THRUSTERS
 (SYSTEMS CONTRACTOR: SCARBAK PROPULSION SYSTEMS, CAIRO, EARTH)
 "TRENTIS" PULSED LASER REACTION CONTROL SYSTEM
 (SYSTEM CONTRACTOR: DRAGE IJEK, AKSAJAK, ANDOR)

LIFE SUPPORT: MB-4A ARTIFICIAL GRAVITY GENERATOR; "ESCUDO" RADIATION SHIELDING
 (SYSTEMS CONTRACTOR: CRISTOBAL SM/S, MANILA, EARTH)
 "CERIX" WASTE REGENERATION SYSTEMS
 (SYSTEMS CONTRACTOR: JULLUNDUR-LAHORE LTD., BOMBAY, EARTH)

RS: 480371.3

TO: 01:04:01:12.19

AMENDMENT CODE: OR

AUTHENTICATED STARDATE 8575.96



FEDERATION STARSHIP

CLASS ONE MK XV/02 BACKGROUND & CLASS LISTING

BACKGROUND OF RENNER CLASS:

IT WAS NOT UNTIL 2268 THAT NEW SLOOP DESIGNS FOLLOWED THAT OF THE FOUR YEARS WAR FLOWER CLASS. THESE WERE THE LARGER BLACK SWAN CLASS, THE SMALLER GUILLEMOTS, AND THE MINESWEEPING SLOOPS OF THE HALCYON CLASS. BY 2271 IT WAS CLEAR THAT WAR WAS IMMINENT. TO SUPPLEMENT THE SLOOPS ON BORDERSPACE AND SPACELANE PATROL AND ESCORT DUTY REAR ADMIRAL ANDREW CUNNINGHAM, THEN CHIEF OF SPACECRAFT, PROPOSED THE HUNT CLASS ESCORT DESTROYERS, AND IN APRIL 2272 STAR FLEET AND OUDEMANS DOCK COMPANY WERE COLLABORATING ON THE DESIGN OF ANOTHER SUCH SHIP. IT WAS THIS DESIGN THAT EVENTUALLY BECAME THE RENNER CLASS.

THE NUMBERS AND TYPES OF SHIPS BEING PUT FORTH WERE STILL CONSIDERED INADEQUATE TO COMPLETELY MEET THE NEED, THUS PROPOSALS FOR THE LARGER KNOX AND DARAN CLASS FRIGATES FOLLOWED. THEN IN 2274 CAME THE "CAMMELL IV" REVELATIONS AND THE SERIES OF CUTBACKS THAT WERE TO PLAGUE STAR FLEET FOR THE REST OF THE DECADE, RESULTING IN DELAYS TO ALL THE AFOREMENTIONED PROGRAMS. THE RENNER PROGRAM WAS POSTPONED AND NOT REAPPROVED UNTIL APPROPRIATIONS INCREASED WITH THE RENEWAL OF TENSIONS BETWEEN THE FEDERATION AND THE KLINGON/ROMULAN ALLIANCE EARLY IN THE 2280'S.

EARLIER PLANS WERE MODIFIED SOMEWHAT, WITH THE FINAL DESIGN BEING REDESIGNATED A CORVETTE. IT WAS STILL SIMILAR TO THE HUNTS WITH THE EXCEPTIONS THAT THE RENNERS HAVE TWO (INSTEAD OF ONE) OF THE SCARBAK RTA IMPULSE UNITS, AND A DISTINCTIVE WEDGE-SHAPED (INSTEAD OF OVOID) PRIMARY HULL. THE RESULT IS A STARSHIP WITH FASTER ACCELERATION TO CRITICAL MOMENTUM, BUT SLOWER ACCELERATION TO A LOWER FULL WARP. MOREOVER, WHILE THE HULL DESIGN SLOWS THE SHIPS UP A BIT IN HYPERSPACE, IT PROVIDES FOR EXCELLENT COMPARTMENTALIZATION AND DEFLECTOR SHIELD CONFORMITY, INCREASING RESISTANCE TO WEAPONS FIRE. SUCH MODIFICATIONS, RESULTING IN DIFFERENCES TO BE EXPECTED WHEN CONTRASTING CORVETTE AND ESCORT DESTROYER DESIGNS, WERE MADE TO INCREASE TACTICAL/MISSION DIVERSITY AMONG SMALL CLASS ONE BORDER VESSELS.

THE SUCCESS OF THE RENNERS AND THE UNEXPECTED STEALTHINESS OF THE DESIGN HAS LED TO REQUESTS FOR CONSTRUCTION OF ADDITIONAL SHIPS OF THE CLASS TO BE DEPLOYED WITH TACFLEET AND OUTFITTED WITH LONG-RANGE SURVEILLANCE AND SUBSPACE JAMMING SYSTEMS. AS OF THIS DATE THESE REQUESTS HAVE NEITHER BEEN APPROVED NOR DENIED.

CLASS LISTING OF RENNER CLASS:

<u>NAME</u>	<u>NCC NUMBER</u>	<u>COMMISSIONED</u>	<u>STATUS</u>	<u>NAME</u>	<u>NCC NUMBER</u>	<u>COMMISSIONED</u>	<u>STATUS</u>
RENNER	3250	13 MAR 2284	A2S	SHAH JAHAN	3261	23 APR 2286	RDF
ROBUST	3251	03 AUG 2284	ATAC	BUXXSHAT	3262	SD 8650.23	A1S
MANTIS	3252	04 OCT 2284	A2S	ESCOVEDO	3263	18 JUNE 2286	A2S
VICTORY	3253	SD 8495.50	A2N	VALOROUS	3264	SD 8670.31	A3N
DAUNTLESS	3254	19 FEB 2285	A4S	JULGUASTH	3265	SD 8575.95	ATAC
ARCADIA	3255	SD 8525.51	A2S	TASHANKA	3266	SD 8706.27	A2S
SERENE	3256	SD 8550.58	A0	ERAND	3267	SD 8702.13	ATC
INVINCIBLE	3257	25 JUNE 2285	A2S	KATANA	3268	12 MAR 2287	ATC
AXBRELL	3258	SD 8575.12	A3N	DURANT	3269	16 APR 2287	A3S
IXAARN	3259	SD 8580.10	A0	REGAL	3270	27 AUG 2287	RDF
MAKO	3260	07 JAN 2286	A3S				

RS: 480371.6

TO: 01:04:01:15.11

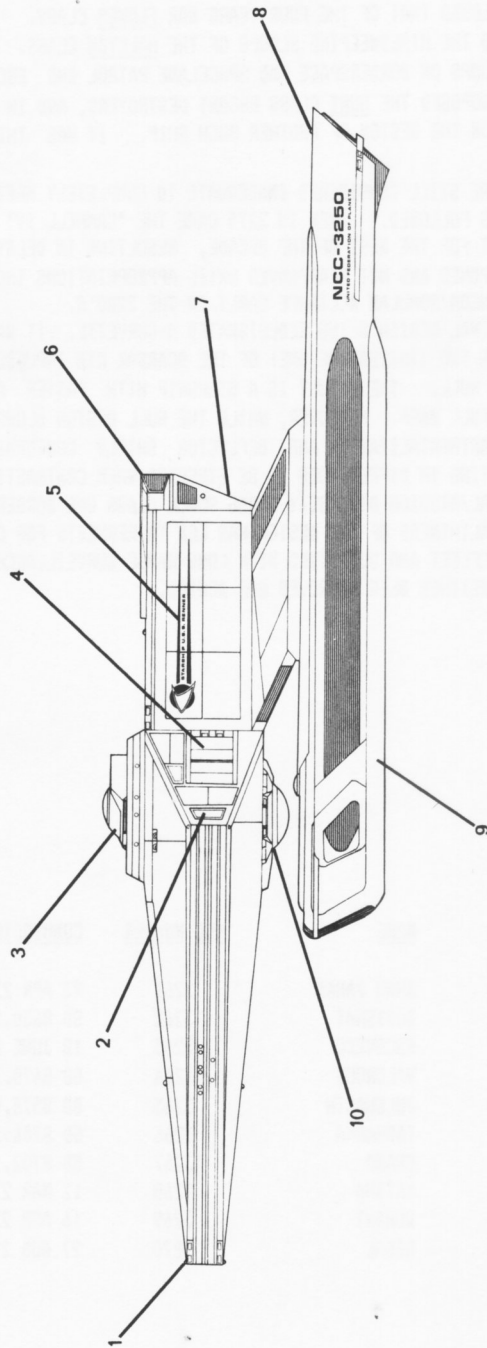

UNITED FEDERATION OF PLANETS
STAR FLEET DIVISION
 BUREAU OF OPERATIONS - OFFICE OF RECORDS

GENERAL PLANS	SPACECRAFT CLASS: CLASS ONE STARSHIP OF THE LINE
MODEL: MK-XV/02	NOMINAL CLASS: CORVETTE
GENERATED BY: MASTERCOM SFHQ	RENDER: RENNER
	SCALE: 1:1366

SUBFILE TWO: OUTBOARD PROFILE

- TO:01:04:01:15.12
 RS:480371*6
- SPECIFICS:
1. BOW LIGHT
 2. AFT MANEUVERING THRUSTER-P/S
 3. BRIDGE
 4. FLIGHT DECK ACCESS DOORS-P/S
 5. STAR FLEET I.D. PENNANT
 6. IMPULSE PROPULSION HOUSING
 7. WEAPONS PACKAGE
 8. NAVIGATION LIGHT-P/S
 9. WARP PROPULSION NACELLE-P/S
 10. MAIN SENSOR ARRAY





STAR FLEET REFERENCE REPORT

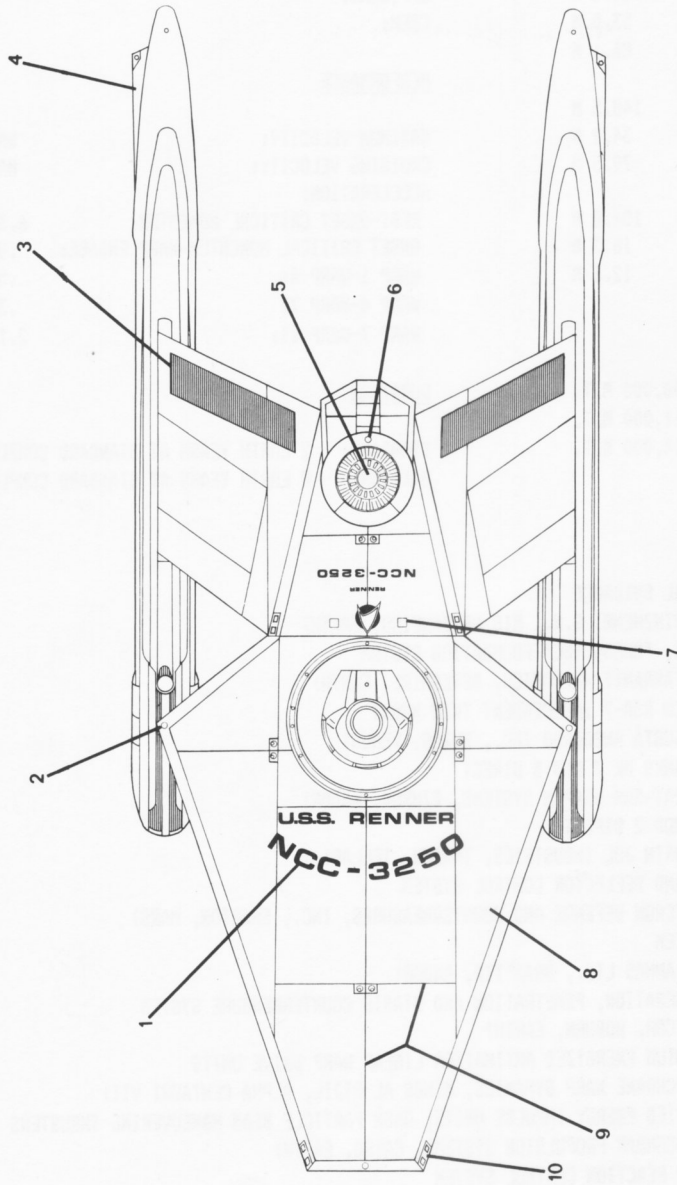

SUBFILE THREE: OUTBOARD TOP VIEW

RS:480371+6

TO:01:04:01:15:13

SPECIFICS:

- 1. NOMINAL AND NUMERIC I.D.
- 2. RUNNING LIGHT-P/S
- 3. EMERGENCY FLUSH VENT-P/S
- 4. INTERCOOLER-P/S
- 5. IMPULSE DEFLECTION CRYSTAL
- 6. FORMATION LIGHT
- 7. AIRLOCK LIFT HATCH (2)
- 8. PRIMARY HULL
- 9. REFLECTOR GRID
- 10. REACTION CONTROL THRUSTER

UNITED FEDERATION OF PLANETS
STAR FLEET DIVISION
 BUREAU OF OPERATIONS - OFFICE OF RECORDS

GENERAL PLANS	SPACECRAFT CLASS: CLASS ONE STARSHIP OF THE LINE
MODEL: NK-YV/02	NOMINAL CLASS: CORVETTE
GENERATED BY: MASTERCOM SFHQ	RENDER: RENNER
SCALE: 1:1366	





FEDERATION STARSHIP

CLASS ONE MK XV/02 SPECIFICATIONS

CURRENT SPECIFICATIONS OF RENNER CLASS:

DIMENSIONS

OVERALL LENGTH: 220.8 M
 OVERALL DRAUGHT: 53.0 M
 OVERALL BEAM: 86.1 M

PRIMARY HULL LENGTH: 148.5 M
 PRIMARY HULL DRAUGHT: 34.2 M
 PRIMARY HULL BEAM: 79.5 M

NACELLE LENGTH: 154.8 M
 NACELLE DRAUGHT: 18.3 M
 NACELLE BEAM: 12.6 M

DISPLACEMENT

LIGHT: 108,000 M.T.
 STANDARD: 111,000 M.T.
 FULL LOAD: 114,000 M.T.

SHIP'S COMPLEMENT

OFFICERS: 54
 CREW: 126

PERFORMANCE

MAXIMUM VELOCITY: WARP 11
 CRUISING VELOCITY: WARP 7
 ACCELERATION:
 REST-ONSET CRITICAL MOMENTUM: 6.30 SEC
 ONSET CRITICAL MOMENTUM-WARP ENGAGE: .83 SEC
 WARP 1-WARP 4: .50 SEC
 WARP 4-WARP 7: .39 SEC
 WARP 7-WARP 11: 2.11 SEC

DURATION

STANDARD: 2 EARTH YEARS AT STANDARD COMPLEMENT
 MAXIMUM: 8 EARTH YEARS AT STANDARD COMPLEMENT

SYSTEMS

NAVIGATION: "NAVRAM" WARP CELESTIAL GUIDANCE
 (SYSTEM CONTRACTOR: PRINZHENRI S.N., RIO DE JANEIRO, EARTH)

COMPUTERS: "SORTIK" DUOTRONIC III, "MNEMOSYNE" FOUNDATION SYSTEM
 (SYSTEMS CONTRACTOR: FARRANTI MNEMONICS, BERKSHIRE, EARTH)

WEAPONS: PHASERS: 6 BANKS/2 EACH RSA-7 INDEPENDENT TWIN MOUNT
 (SYSTEM CONTRACTOR: AGUSTA ANSADADO INC., FUZES, VENUS)
 PHOTON TORPEDOES: 2 BANKS MK 7 MOD 5 DIRECT
 (SYSTEM CONTRACTOR: SKAT-RAR WEAPON SYSTEMS, EZURUK, ANDOR)
 MINES: 2 BANKS MLS-3 MOD 2 DIRECT
 (SYSTEM CONTRACTOR: KHRIN JOL INDUSTRIES, TANBUN, TELLAR)

DEFENSE: "MICRON" FORCE FIELD AND DEFLECTOR CONTROL SYSTEM
 (SYSTEM CONTRACTOR: MICRON DEFENSE AND COUNTERMEASURES, INC., SHARTON, MARS)
 RRCT FIRE CONTROL SYSTEM
 (SYSTEM CONTRACTOR: LIANHAS LTD., BRAA'TIN, ANDOR)
 CGCP/SCDS CLOAKING GENERATION, PENETRATION AND STASIS COUNTERMEASURE SYSTEM
 (SYSTEM CONTRACTOR: HYCOR, WOBURN, EARTH)

PROPULSION: (2) LN-64 MOD 5 DILITHIUM ENERGIZED ANTIMATTER LINEAR WARP DRIVE UNITS
 (SYSTEM CONTRACTOR: COCHRANE WARP DYNAMICS, MINDS AL RIJIL, ALPHA CENTAURI VII)
 (2) RTA SUBATOMIC UNIFIED ENERGY IMPULSE UNITS; GASR PARTICLE BEAM MANEUVERING THRUSTERS
 (SYSTEMS CONTRACTOR: SCARBAK PROPULSION SYSTEMS, CAIRO, EARTH)
 "TRENTIS" PULSED LASER REACTION CONTROL SYSTEM
 (SYSTEM CONTRACTOR: ORAGE IJEK, AKSAJAK, ANDOR)

LIFE SUPPORT: MD-2T ARTIFICIAL GRAVITY GENERATOR; "OKARIN" RADIATION SHIELDING
 (SYSTEMS CONTRACTOR: TIDJIKJA/ATAR ASSOCIATED IND., RASTARIBI, REGULUS)
 "STRATIX" WASTE REGENERATION SYSTEM
 (SYSTEM CONTRACTOR: JULLUNDUR-LAHORE LTD., BOMBAY, EARTH)

RS: 480371.6

TO:01:04:01:15.19



FEDERATION STARSHIP

CLASS ONE MK XX/02 BACKGROUND & CLASS LISTING

BACKGROUND OF BELKNAP CLASS :

THE EFFORTS TO DEVELOP A HYPERPHOTIC PROPULSION SYSTEM THAT WOULD MULTIPLY FIELD STRENGTH BY ALTERING THE CONFIGURATION OF A STARSHIP'S WARP BUBBLE LED TO A NUMBER OF NEW IDEAS CONCERNING WARP DYNAMIC STREAMLINING. BUILDING ON THESE IDEAS AND ON THE SUCCESSFUL HEAVY CRUISER DESIGN, THE STAR FLEET BUREAU OF SPACECRAFT DEVELOPED PLANS FOR A CIRCUMFERENTIAL WARP DRIVEN CRUISER SIMILAR TO THE LARGER CONSTITUTION-BONHOMME RICHARD-ACHERNAR SERIES BUT INCORPORATING THE LATEST STREAMLINING THEORIES. IN 2263 APPROVAL WAS GIVEN FOR THE BUILDING OF A PROTOTYPE VESSEL. CONSTRUCTION WAS DELAYED HOWEVER, BY THE SUCCESSFUL SIMULATION TESTS LATER THAT YEAR OF THE LN-64 LINEAR WARP DRIVE. MODIFICATIONS PERMITTING THIS LINKED IMPULSE/WARP PROPULSION SYSTEM TO BE INSTALLED WERE MADE TO THE INTERIOR ARRANGEMENT, AND FURTHER STREAMLINING WAS DONE TO THE EXTERIOR DESIGN. CONSTRUCTION WAS FINALLY STARTED IN LATE 2265 AND WHEN LAUNCHED FOURTEEN MONTHS LATER THE U.S.S. DECATUR BECAME THE FIRST STARSHIP EQUIPPED WITH LINEAR WARP DRIVE.

EXAMINATION OF THE WARP DYNAMICS OF THIS DESIGN, AND THE EFFICIENCY AND RELIABILITY OF THE PROPULSION SYSTEMS, LED TO FURTHER MODIFICATIONS INCORPORATED FIRST IN THE BONHOMME RICHARD / CONSTITUTION REDESIGN PROGRAM, THEN IN BELKNAP AND HER SISTERS, AND FINALLY THROUGHOUT THE CLASS ONE FLEET. THE BELKNAP STARSHIPS, CLOSE "HALF-SISTERS" OF DECATUR, NOT ONLY INCORPORATE THESE MODIFICATIONS, BUT ALSO COMBINE MANY OF THE FEATURES OF THE LARGER HEAVY CRUISERS AND DREADNOUGHTS INTO A SMALLER, MORE WARP DYNAMIC DESIGN. LONG RANGE SCANNING, NAVIGATION, DAMAGE CONTROL, AND TACTICAL BATTLE SYSTEMS EQUAL OR SURPASS THOSE FOUND IN OTHER CLASSES. THE SMALLER HULL DOES LIMIT THE AMOUNT OF LABORATORY SPACE ABOARD SHIP, AND THUS WHILE ON EXPLORATORY DUTY BELKNAP CLASS STARSHIPS ACT AS SUPPORT SHIPS IN TASK FORCES FORMED AROUND BETTER EQUIPPED HEAVY CRUISERS. ON THE MANY BORDERSPACE PATROLS AND OTHER HAZARDOUS DEFENSE AND LAW ENFORCEMENT ASSIGNMENTS THAT FORM THE BULK OF MARK 20 DUTY HOWEVER, THE STARSHIPS ARE MORE THAN CAPABLE OF GOING IT ALONE.

HAVING BEEN ONE OF THE FEW EXAMPLES OF A STARSHIP DEVELOPMENT PLAN TO BE REALIZED UNDER BUDGET, AHEAD OF SCHEDULE, AND SURPASSING EXPECTATIONS, THE BELKNAP PROGRAM HAS IN EVERY WAY PROVEN TO BE A SUCCESS. FUTURE PLANNERS CAN LEARN IMPORTANT LESSONS FROM HEEDING THIS EXAMPLE.

CLASS LISTING OF BELKNAP CLASS:

NAME	NCC NUMBER	COMMISSIONED	STATUS	NAME	NCC NUMBER	COMMISSIONED	STATUS
DECATUR	2500	12 MAY 2270	ATRA	HAVEN	2514	17 FEB 2282	A2S
BELKNAP	2501	07 FEB 2274	A1N	BRIZA	2515	02 OCT 2282	A0
BRADLEY	2502	28 JUNE 2276	A2S	MIKUMA	2516	SD 8471.28	A3S
KHIRIRAT	2503	06 NOV 2276	A2S	SHANGRI-LA	2517	SD 8591.62	A4S
HAVERSHAM	2504	SD 7402.51	A3N	HAI DIN	2518	29 APR 2283	A0
SOVEREIGN	2505	29 JULY 2278	A0	RAAN	2519	SD 8621.37	ATAC
CONCORD	2506	SD 7732.53	A4S	DELPHIN	2537*	SD 8698.19	A3N
RISHIRI	2507	06 MAR 2280	A1N	SENECA	2538	SD 8759.23	A1S
ESSAHIR	2508	SD 8195.60	A0	KI RIN	2539	25 NOV 2283	A3S
JARRETT	2509	SD 8291.75	A4N	CICALA	2540	SD 8851.33	A2N
FAHRION	2510	23 AUG 2280	A1S	SUR CHA	2541	SD 8926.27	ATAC
ESTOCIN	2511	12 NOV 2280	A2N	MIRA	2542	SD 9034.61	A1S
MATSURRA	2512	16 OCT 2281	ATAC	AVELEY	2543	SD 9119.47	A3S
BAIKAL	2513	SD 8442.31	A0	ALOR	2544	16 SEPT 2284	A4N

*2520-2529 ASSIGNED TO ASCENSION CLASS DREADNOUGHTS. 2530 -2536 UNASSIGNED (CANCELED HULLS).

RS: 480371.6

TO: 01:04:01:20.11

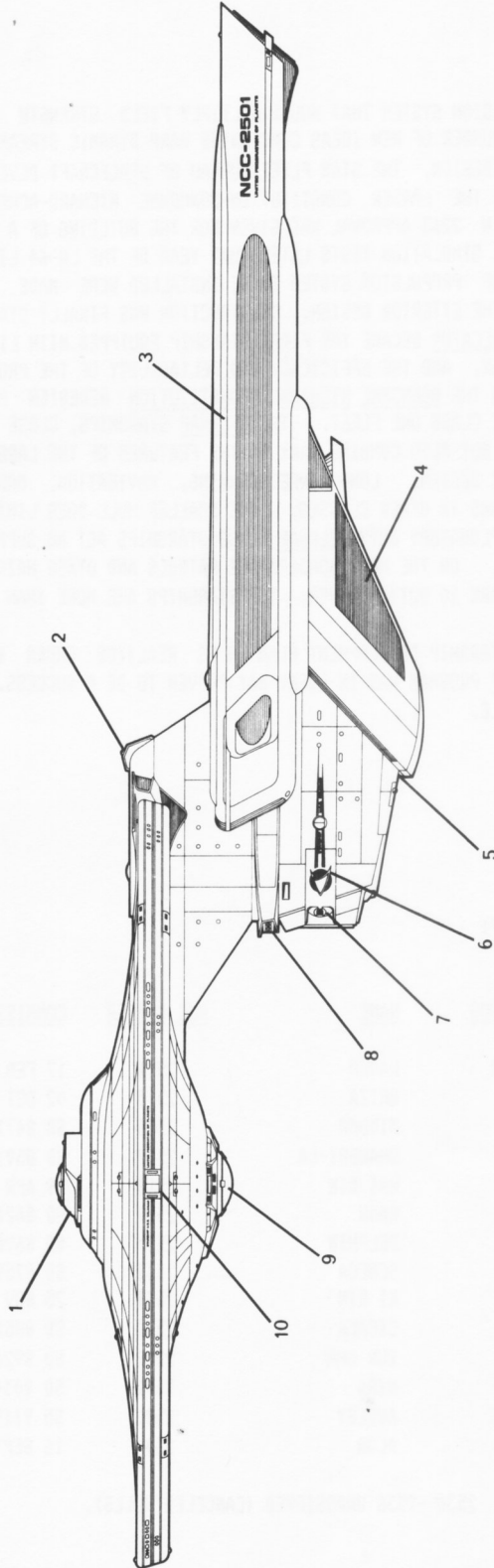

UNITED FEDERATION OF PLANETS
STAR FLEET DIVISION
BUREAU OF OPERATIONS - OFFICE OF RECORDS

GENERAL PLANS		SPACECRAFT CLASS: CLASS ONE STARSHIP OF THE LINE	
MODEL: MK-XX/02	TYPE: STRIKE CRUISER	NOMINAL CLASS: BELKNAP	
GENERATED BY: MASTERCOM SFHQ		SCALE:	1:1366

SUBFILE TWO: OUTBOARD PROFILE

- RS:480371*6
TO:01:04:01:20.12
- SPECIFICS:
1. BRIDGE
2. AFT PHASER TURRET
3. WARP PROPULSION NACELLE-P/S
4. EMERGENCY FLUSH VENT-P/S
5. PYLON ATTACHMENT AREA
6. STAR FLEET I.D. PENNANT
7. SPACE ENERGY FIELD SENSOR (3)
8. PHOTON TORPEDO EJECTOR-P/S
9. NAVIGATIONAL DOME-T/B
10. MAIN GANGWAY HATCH





STAR FLEET REFERENCE REPORT

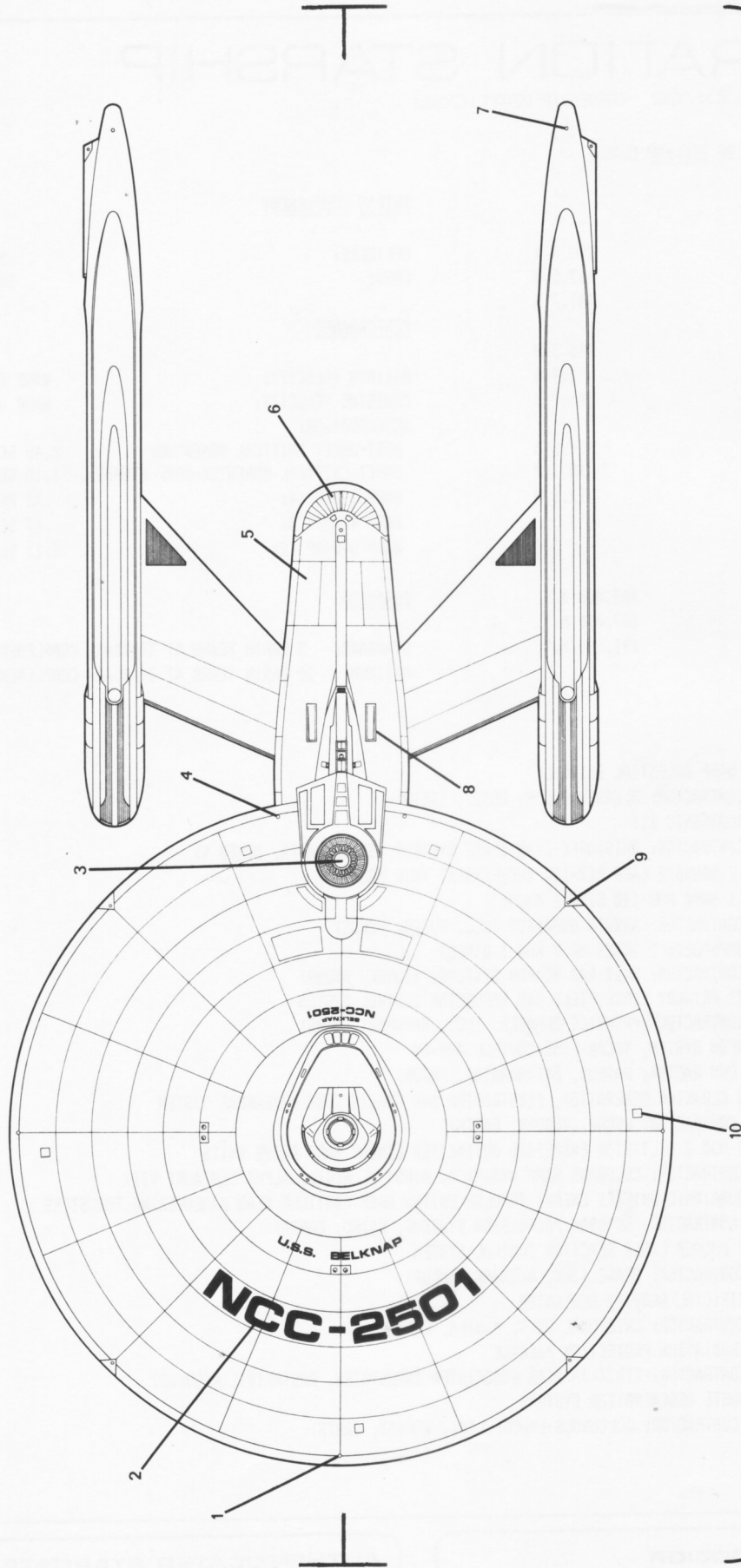

SUBFILE THREE: OUTBOARD TOP VIEW

- RS: 480371+6
- TO: 01:04:01:20.13
- SPECIFICS:
1. BOW LIGHT
 2. NOMINAL AND NUMERIC I.D.
 3. IMPULSE DEFLECTION CRYSTAL
 4. FORMATION LIGHT-P/S
 5. SECONDARY HULL
 6. FLIGHT DECK ACCESS DOORS
 7. NAVIGATION LIGHT-P/S
 8. AFT MANEUVERING THRUSTER-P/S
 9. REACTION CONTROL THRUSTER
 10. ATRLOCK LIFT HATCH (5)

UNITED FEDERATION OF PLANETS
 STAR FLEET DIVISION
 BUREAU OF OPERATIONS - OFFICE OF RECORDS

GENERAL PLANS		SPACECRAFT CLASS:	
CLASS ONE STARSHIP OF THE LINE		CLASS ONE STARSHIP OF THE LINE	
MODEL: HK-XX/02	TYPE: STRIKE CRUISER	NOMINAL CLASS:	BELKNAP
GENERATED BY: MASTERCOM SFHQ	SCALE: 1:1366		





FEDERATION STARSHIP

CLASS ONE MK XX/02 SPECIFICATIONS

CURRENT SPECIFICATIONS OF BELKNAP CLASS:

DIMENSIONS

OVERALL LENGTH: 290.0 M
 OVERALL DRAUGHT: 67.5 M
 OVERALL BEAM: 141.7 M

PRIMARY HULL LENGTH: 146.3 M
 PRIMARY HULL DRAUGHT: 32.9 M
 PRIMARY HULL BEAM: 141.7 M

NACELLE LENGTH: 154.8 M
 NACELLE DRAUGHT: 18.3 M
 NACELLE BEAM: 12.6 M

DISPLACEMENT

LIGHT: 183,000 M.T.
 STANDARD: 187,000 M.T.
 FULL LOAD: 191,500 M.T.

SHIP'S COMPLEMENT

OFFICERS: 55
 CREW: 340

PERFORMANCE

MAXIMUM VELOCITY: WARP 12
 CRUISING VELOCITY: WARP 8
 ACCELERATION:
 REST-ONSET CRITICAL MOMENTUM: 8.48 SEC
 ONSET CRITICAL MOMENTUM-WARP ENGAGE: 1.10 SEC
 WARP 1-WARP 4: .75 SEC
 WARP 4-WARP 8: .67 SEC
 WARP 8-WARP 12: 2.11 SEC

DURATION

STANDARD: 5 EARTH YEARS AT STANDARD COMPLEMENT
 MAXIMUM: 20 EARTH YEARS AT STANDARD COMPLEMENT

SYSTEMS

NAVIGATION: "HAWKEYE WARP CELESTIAL GUIDANCE
 (SYSTEM CONTRACTOR: PLESSEY GROUP, ESSEX, EARTH)

COMPUTERS: "SABLE" DUOTRONIC III
 (SYSTEM CONTRACTOR: ERISTAFFE-ZYNN SPACE SYSTEMS, SEBALDHASTA, DENEV V)

WEAPONS: PHASERS: 7 BANKS/2 EACH RIM-12C INDEPENDENT TWIN MOUNT
 1 BANK RSM-14B SINGLE MOUNT
 (SYSTEM CONTRACTOR: AGUSTA ANSADADD INC., FUZES, VENUS)
 PHOTON TORPEDOES: 2 BANKS MK 7 MOD 1 DIRECT
 (SYSTEM CONTRACTOR: SKAT-RAR WEAPON SYSTEMS, EZURUK, ANDOR)

DEFENSE: "LANCLOT" PRIMARY FORCE FIELD AND DEFLECTOR CONTROL SYSTEM
 (SYSTEM CONTRACTOR: PRENTICE-SCHAFFER, INC., MARSPOET, MARS)
 CETIS WEAPON SYSTEM, TACAR FIRE CONTROL ADD-ON
 (SYSTEMS CONTRACTOR: RAAKUV, GAZIWAHAIDA, ANDOR)
 CGCP/SCDS CLOAKING GENERATION, PENETRATION AND STASIS COUNTERMEASURE SYSTEM
 (SYSTEMS CONTRACTOR: HYCOR, WOBURN, EARTH)

PROPULSION: (2) LN-64 MOD 3 DILITHIUM ENERGIZED ANTIMATTER LINEAR WARP DRIVE UNITS
 (SYSTEM CONTRACTOR: COCHRANE WARP DYNAMICS, MINOS AL RIJIL, ALPHA CENTAURI VII)
 (2) RSL SUBATOMIC UNIFIED ENERGY IMPULSE UNITS; QASR PARTICLE BEAM MANEUVERING THRUSTERS
 (SYSTEMS CONTRACTOR: SCARBAK PROPULSION SYSTEMS, CAIRO, EARTH)
 "TRENTIS" PULSED LASER REACTION CONTROL SYSTEM
 (SYSTEM CONTRACTOR: DRAGE IJEK, AKSAJAK, ANDOR)

LIFE SUPPORT: MC-3E ARTIFICIAL GRAVITY GENERATOR
 (SYSTEM CONTRACTOR: CRISTOBAL SM/S, MANILA, EARTH)
 "RASTIS" RADIATION PROTECTION PACKAGE
 (SYSTEM CONTRACTOR: TIDJIKJA/ATAR ASSOCIATED INDUSTRIES, RASTARIBI, REGULUS)
 "CERIX" WASTE REGENERATION SYSTEMS
 (SYSTEMS CONTRACTOR: JULLUNDUR-LAHORE LTD., BOMBAY, EARTH)

RS: 480371.6

TO:01:04:01:20:19



FEDERATION SPACECRAFT

CLASS TWO MK F BACKGROUND & SERIES LISTING

BACKGROUND OF INDEPENDENCE CLASS:

NOT LONG AFTER THE DEVELOPMENT OF THE CLASS ONE STARSHIP MODULAR COMPONENT SYSTEM (ARISING FROM THE MK IX HEAVY CRUISER DESIGN) DURING THE LATE 2210'S, THE REQUIREMENTS ANALYSIS BOARD ISSUED A REPORT INDICATING THE DESIRABILITY OF HAVING A SIMILAR COMPONENT SYSTEM MADE AVAILABLE FOR CLASS TWO AND CLASS THREE SPACECRAFT. ONE OF THE FIRST DESIGNS TO EMERGE IN ACCORDANCE WITH THIS REPORT WAS THE CLASS TWO MK F TRANSPORT/FREIGHTER, DEVELOPED TO SUPPLEMENT THE CLASS ONE MK VI TRANSPORT FLEET.

ALL OF THESE INDEPENDENCE CLASS TRANSPORTS WERE ASSEMBLED AT FACILITIES IN EARTH ORBIT. BETWEEN JUNE 2229 AND APRIL 2240, 514 WERE COMMISSIONED. WHILE EXTERNALLY IDENTICAL, THE SIX SEPARATE SERIES THAT FORM THIS CLASS HAVE DIFFERING INTERNAL CONFIGURATIONS, REFLECTING THE SPECIFIC CARGO TYPES EACH IS DESIGNED TO CARRY. FOR INSTANCE, WHILE THE FREEDOM SERIES IS DESIGNED PRIMARILY FOR THE TRANSPORT OF LIQUID AND GASEOUS LOADS, THE LIBERTY SERIES IS OUTFITTED TO CARRY MORE VOLATILE CARGOES SUCH AS ANTIMATTER AND CERTAIN PLASMAS, AND THE JUSTICE SERIES CAN CARRY HUMANOID CARGOES FOR SUCH PURPOSES AS EVACUATION, SETTLEMENT, OR TROOP MOVEMENT. THE INDEPENDENCE, EQUALITY, AND FRATERNITY SERIES ARE DESIGNED FOR MORE GENERAL TRANSPORT TASKS.

ON 06 JUNE 2240 THE OFFICE OF PROCUREMENT CANCELLED ITS ORDER FOR 100 FRATERNITY SERIES TRANSPORTS AFTER DELIVERY OF ONLY 14. AT THE TIME THIS SEEMED TO BE A PRUDENT RESPONSE TO INCREASING BUDGETARY PRESSURES PLACED ON STAR FLEET BY THE FEDERATION COUNCIL. WITHIN SEVERAL YEARS HOWEVER, THE FOUR YEARS WAR STARTED AND THE TRANSPORT COMMAND IMMEDIATELY REALIZED THAT THE DECISION TO CANCEL HAD BEEN A MISTAKE. FACED WITH IMPOSSIBLE SUPPLY DEMANDS, STAR FLEET WAS FORCED TO WORK INDEPENDENCE CLASS SPACECRAFT IN SIGNIFICANT EXCESS OF ESTABLISHED CRITERIA FOR STRESS AND ENDURANCE.

LESSONS LEARNED FROM THE WAR LED TO THE DEVELOPMENT OF NEW TRANSPORTS, AND TO THE ATTENTIVE UPKEEP OF THE INDEPENDENCE CLASS FLEET. NEVERTHELESS, OF THE ORIGINAL 514 TRANSPORTS, ONLY 380 ARE STILL IN ACTIVE SERVICE. A NUMBER OF THESE SPACECRAFT WERE LOST DURING THE EARLY- AND MID-2260'S, FIRST BY KLINGON RAIDING PARTIES IN THE PERIOD OF TENSION LEADING UP TO THE ORGANIAN CONFLICT, AND LATER BY THE RESURGENT ORION PIRATES.

ONE TRANSPORT IS WORTH PARTICULAR NOTE IN THIS CONTEXT. ON SD 6344.10, U.S.S. HURON (NCC-F1313) WAS ATTACKED BY ORION PIRATES AND DAMAGED BEYOND REPAIR. A DILITHIUM FREIGHTER OUT OF THE CANOPIS STAR SYSTEM, HURON WAS ON AN ERRAND OF MERCY, TRANSPORTING THE DRUG STROBOLIN TO THE HEAVY CRUISER ENTERPRISE (NCC-1701), WHOSE EXECUTIVE OFFICER WAS STRICKEN WITH CHORIOCYTOSIS. THE CONFRONTATION ENDED BETTER THAN MIGHT BE EXPECTED, HOWEVER. FOR SHOWING EXCEPTIONAL SKILL IN SAVING HIS SHIP AND CREW FROM TOTAL DESTRUCTION, LIEUTENANT COMMANDER MICHAEL O'SHEA WAS AWARDED THE GRANKITE ORDER OF TACTIC. FURTHERMORE, THE CREW RECEIVED A STAR FLEET COMMENDATION, AND ENTERPRISE RECOVERED THE STOLEN MEDICINE IN TIME TO SAVE THE AILING OFFICER'S LIFE.

SERIES LISTING OF INDEPENDENCE CLASS:

NAME	NCC NUMBERS	COMMISSIONED
<u>INDEPENDENCE</u> SERIES	F1300 - F1399	2229 - 2232
<u>FREEDOM</u> SERIES	F1400 - F1499	2231 - 2233
<u>EQUALITY</u> SERIES	F1500 - F1599	2234 - 2237
<u>LIBERTY</u> SERIES	F1600 - F1699	2235 - 2238
<u>JUSTICE</u> SERIES	F1700 - F1799	2237 - 2240
<u>FRATERNITY</u> SERIES	F1800 - F1813	2239 - 2240

ABBREVIATED FOR REASONS OF SPACE. FOR COMPLETE CLASS LISTING AND STATUS REPORT ENTER AT PROMPT "T.O.?" "01:04:02:06.01 (SUBFILE 1.1)".

RS: 480371.3

TO: 01:04:02:06.01

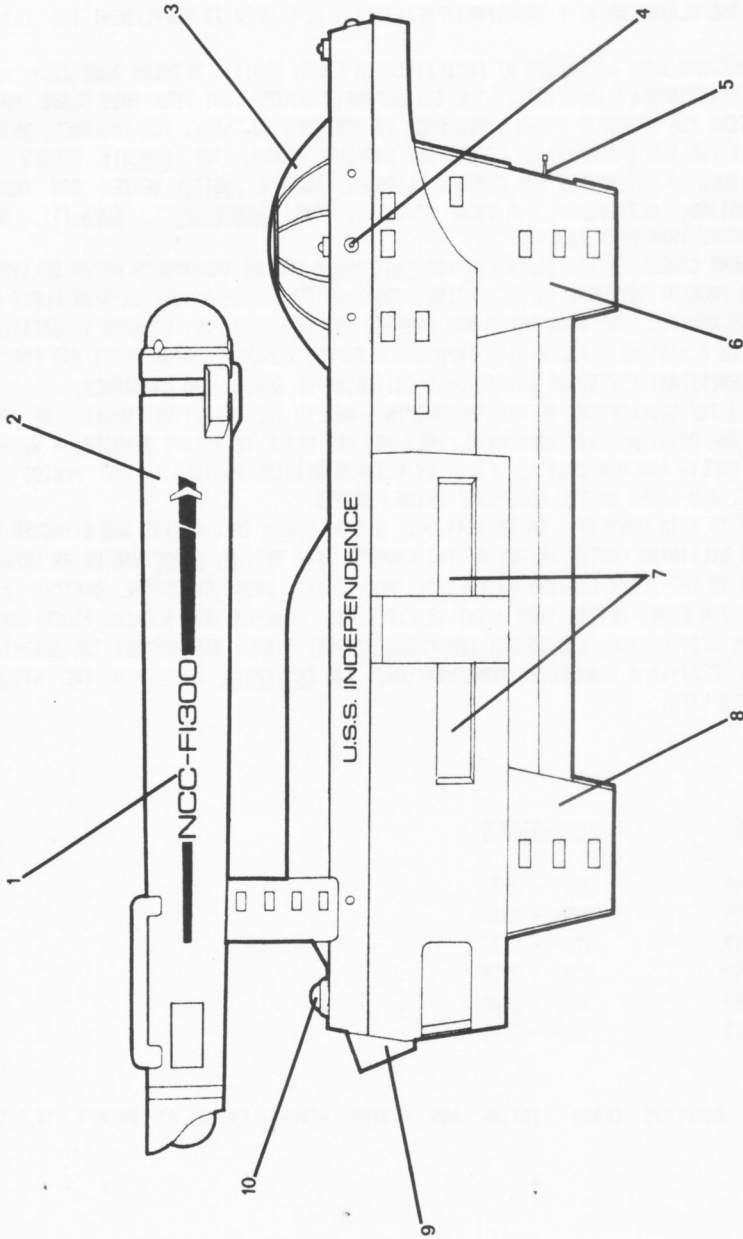

SUBFILE TWO: OUTBOARD PROFILE

RS: 480371-3
 TO: 01:04:02:06.02
 SPECIFICS:
 1. STAR FLEET I.D. PENNANT
 2. WARP PROPULSION NACELLE-P/S
 3. BRIDGE
 4. PHASER TURRET (4)
 5. FORE SENSOR & NAV. DEFLECTOR
 6. SHIP'S SERVICES MODULE
 7. CARGO BAY DOORS-P/S
 8. CREW/PASSENGER MODULE
 9. IMPULSE PROPULSION HOUSING
 10. HOMING BEACON

UNITED FEDERATION OF PLANETS
 STAR FLEET DIVISION
 BUREAU OF OPERATIONS - OFFICE OF RECORDS

GENERAL PLANS	SPACECRAFT CLASS: CLASS TWO SUPPORT SPACECRAFT
MODEL: HK-F	NOMINAL CLASS: INDEPENDENCE
GENERATED BY: MASTERCOM SFHQ	SCALE: 1:489



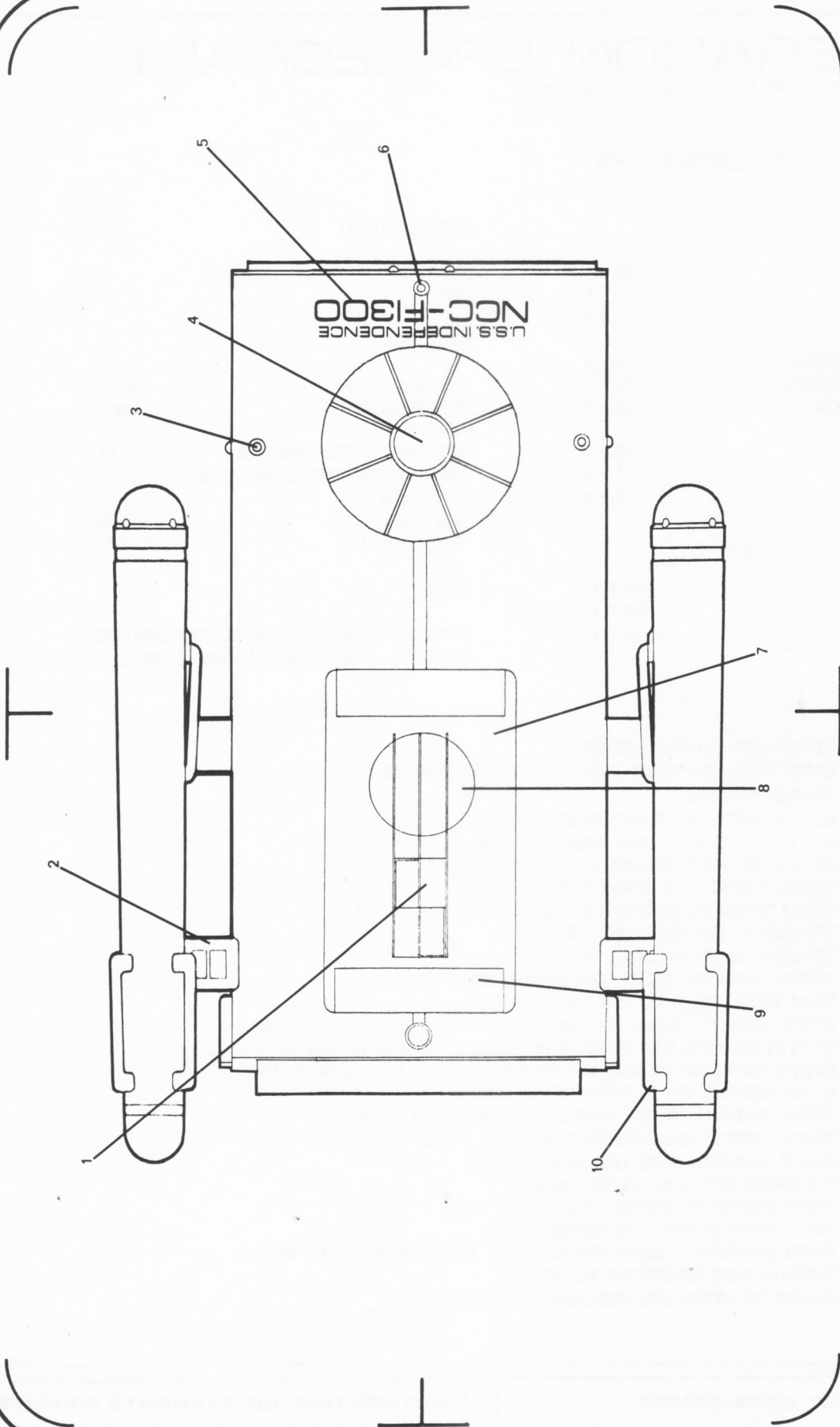

SUBFILE THREE: OUTBOARD TOP VIEW

RS: 480371-3

TO: 01:04:02:06.03

SPECIFICS:

1. LANDING TARGET
2. MACELLE SUPPORT PYLON (4)
3. RUNNING LIGHT-P/S
4. SPACE SENSOR ARRAY
5. NOMINAL & NUMERICAL I. D.
6. BOW LIGHT
7. CARGO BAY
8. TURNABLE/ELEVATOR
9. CARGO BAY DOORS (OPEN)
10. INTERCOOLERS-P/S PER UNIT

UNITED FEDERATION OF PLANETS
STAR FLEET DIVISION
 BUREAU OF OPERATIONS - OFFICE OF RECORDS

GENERAL PLANS

SPACECRAFT CLASS: CLASS TWO SUPPORT SPACECRAFT

MODEL: MK-F TYPE: TRANSPORT/FREIGHTER

NOMINAL CLASS: INDEPENDENCE

GENERATED BY: MASTERCOM SFHQ

SCALE: 1:489





FEDERATION SPACECRAFT

CLASS TWO MK F SPECIFICATIONS

CURRENT SPECIFICATIONS OF INDEPENDENCE CLASS:

DIMENSIONS

OVERALL LENGTH: 82.0 M
 OVERALL DRAUGHT: 34.5 M
 OVERALL BEAM: 55.8 M

PRIMARY HULL LENGTH: 75.9 M
 PRIMARY HULL DRAUGHT: 25.0 M
 PRIMARY HULL BEAM: 39.6 M

NACELLE LENGTH: 73.5 M
 NACELLE DRAUGHT: 7.0 M
 NACELLE BEAM: 7.6 M

DISPLACEMENT

LIGHT: 11,500 M.T.
 STANDARD: 14,000 M.T.
 FULL LOAD: 16,500 M.T.

SHIP'S COMPLEMENT

OFFICERS: 6
 CREW: 19

PERFORMANCE

MAXIMUM VELOCITY: WARP 4
 CRUISING VELOCITY: WARP 2
 ACCELERATION:
 REST-ONSET CRITICAL MOMENTUM: 14.68 SEC
 ONSET CRITICAL MOMENTUM-WARP ENGAGE: 6.31 SEC
 WARP 1-WARP 2: 3.08 SEC
 WARP 2-WARP 3: 1.55 SEC
 WARP 3-WARP 4: 9.62 SEC

DURATION

STANDARD: 2 EARTH YEARS AT STANDARD COMPLEMENT
 MAXIMUM: 6 EARTH YEARS AT STANDARD COMPLEMENT

SYSTEMS

NAVIGATION: "LECTUS" WARP CELESTIAL GUIDANCE
 (SYSTEM CONTRACTOR: MANDOR INDUSTRIES, LTD., DALHALAM, DELTA IV)

COMPUTERS: "CRYSKOM" DUOTRONIC I
 NCC-F1300-F1599: MK 113 MASS MEMORY SUBSYSTEMS
 NCC-F1600-F1813: MK 117 MASS MEMORY SUBSYSTEMS
 (SYSTEMS CONTRACTOR: MATRAMEL LTD., APAGOS, RIGEL IV)

WEAPONS: PHASERS: 4 BANKS 76/32 COMPACT SINGLE MOUNT
 (SYSTEM CONTRACTOR; AEROSPATIALE, ROUSSEAU, MARS)

DEFENSE: "SEN'JINA" PRIMARY FORCE FIELD GENERATOR
 "ABADENDRA" DEFLECTOR CONTROL SYSTEM
 (SYSTEMS CONTRACTOR: RAAKUV, 6AZI WAHAIDA, ANDOR)
 "PUMA" WEAPON, SENSOR AND FIRE CONTROL SYSTEM
 (SYSTEM CONTRACTOR: SIGNAL ELECTRONIC ENTERPRISES, INC., MEDITERRANEA, EARTH)

PROPULSION: (2) PN-12 MOD 3 DILITHIUM ENERGIZED ANTIMATTER CIRCUMFERENTIAL WARP DRIVE UNITS
 (SYSTEMS CONTRACTOR: COCHRANE WARP DYNAMICS, MINDS AL RIJIL, ALPHA CENTAURI VII)
 (4) SSC SUBATOMIC UNIFIED ENERGY IMPULSE UNITS
 (SYSTEM CONTRACTOR: SCARBAK PROPULSION SYSTEMS, CAIRO, EARTH)
 "ADIKIK" CHEMICAL COMBUSTION REACTION CONTROL SYSTEM
 (SYSTEM CONTRACTOR: ORAGE IJEK, AKSAJAK, ANDOR)

LIFE SUPPORT: CT-2/CENTRIS ARTIFICIAL GRAVITY GENERATOR
 (SYSTEM CONTRACTOR: CRISTOBAL SM/S, MANILA, EARTH)
 "KAKTI" RADIATION PROTECTION PACKAGE
 (SYSTEM CONTRACTOR: TIDJIKJA/ATAR ASSOCIATED INDUSTRIES, RASTARIBI, REGULUS)
 "SENSMA-M" WASTE REGENERATION SYSTEMS
 (SYSTEMS CONTRACTOR: JOLLUNDUR-LAHORE LTD., BOMBAY, EARTH)

RS: 480371-3

TO: 01:04:02:06.09

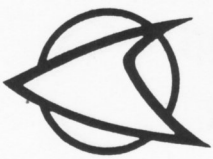

FEDERATION SPACECRAFT

CLASS TWO MK G BACKGROUND & SERIES LISTING

BACKGROUND OF SHERMAN CLASS:

STAR FLEET'S TRANSPORT COMMAND HAS THE RESPONSIBILITY OF PROVIDING SPACELIFT FOR ALL COMPONENTS OF THE STAR FLEET DIVISION. PRIVATE SHIPPING HANDLES THE BULK OF THIS SPACELIFT, BUT STAR FLEET HAS ALWAYS MAINTAINED A FORCE OF CLASS ONE AND TWO TRANSPORTS, FREIGHTERS, AND CARGO VESSELS FOR USE IN UNDERWAY REPLENISHMENT OF RAW AND FINISHED MATERIALS THAT CANNOT BE MANUFACTURED ABOARD FLEET VESSELS. ALSO, IN CRISIS SITUATIONS AND/OR WHEN PRIVATE SHIPPING HAS NOT BEEN ABLE TO GET THROUGH, STAR FLEET VESSELS HAVE ASSISTED IN COLONY AND STARBASE RESUPPLY.

SHERMAN CLASS VESSELS WERE DEVELOPED DURING THE 2230'S UNDER STAR FLEET CONTRACT WITH THE FREEMAN CONSTRUCTION GROUP FOR USE BY STAR FLEET. SINCE THEN MANY HAVE BEEN SOLD OR OTHERWISE REASSIGNED TO PRIVATE MERCHANTS. ON THESE VESSELS THE STAR FLEET NAVIGATIONAL CONTACT CODE IS CHANGED TO A MERCHANT NAVIGATIONAL CONTACT SIGNAL, AND THEY CONSEQUENTLY CARRY THE "NCS" PREFIX ON THEIR NUMERICAL I.D. SUCH VESSELS ARE OTHERWISE INDISTINGUISHABLE FROM THEIR STAR FLEET COUNTERPARTS.

THIS CLASS IS COMPOSED OF FIVE DIFFERENT CONSTRUCTION SERIES, PLUS TWO EARLIER SERIES UPDATED DURING THE 2250'S TO MATCH SHERMAN SPECIFICATIONS. ALL OF THESE VESSELS ORDINARILY OPERATE AS DRONES, BUT CAN AND DO CARRY CREWS ON SECURITY AND OTHER ASSIGNMENTS CALLING FOR MANNED OPERATION.

TECHNOLOGICAL ADVANCES ARE INCREASINGLY MAKING THE MISSION PROFILE OF THIS AND OTHER STAR FLEET REPLENISHMENT VESSELS OBSOLETE. MOST STARSHIPS ARE NOW ABLE TO RECYCLE OR MANUFACTURE NECESSARY RAW AND FINISHED MATERIALS. IN FACT, SUCH ADVANCES HAVE GREATLY REDUCED EVEN THE INTERSTELLAR TRANSPORT OF TRADE GOODS. MUCH TRADE IS NOW CARRIED ON VIA SUBSPACE COMMUNICATION OF MASS PATTERNS, WHICH ARE UPON RECEIPT USED TO PRODUCE THE DESIRED GOODS IN MATTER CONVERSION UNITS. THIS, HOWEVER, DOES NOT MEAN THAT THE TRANSPORT COMMAND OR MERCHANT FLEET WILL SOON DISAPPEAR. THEY ARE BOTH SLOWLY BEING SCALED DOWN IN SIZE TO REFLECT CURRENT NEEDS. AS ONE RESULT, OLDER CARGO VESSELS LIKE THOSE IN THE SHERMAN CLASS ARE BEING SCRAPPED AT THE END OF THEIR SERVICE LIVES, WITH NO REPLACEMENTS BEING CONTEMPLATED.

SERIES LISTING OF SHERMAN CLASS:

NAME	NCC NUMBERS	COMMISSIONED
SYMMA	6128 - 6144 (EX-Q SERIES)	2224 - 2231
SHERMAN	6145 - 6146	2235 - 2237
LINDA	6147 - 6149	2236 - 2239
SUSAN	6150	2239
ALANA	6151 - 6152	2240
DIRDRA	6153 - 6160	2242 - 2244
ALEXIS	6420 - 6434 (EX-Q SERIES)	2230 - 2234

RS: 480371.5

TO: 01:04:02:07.01

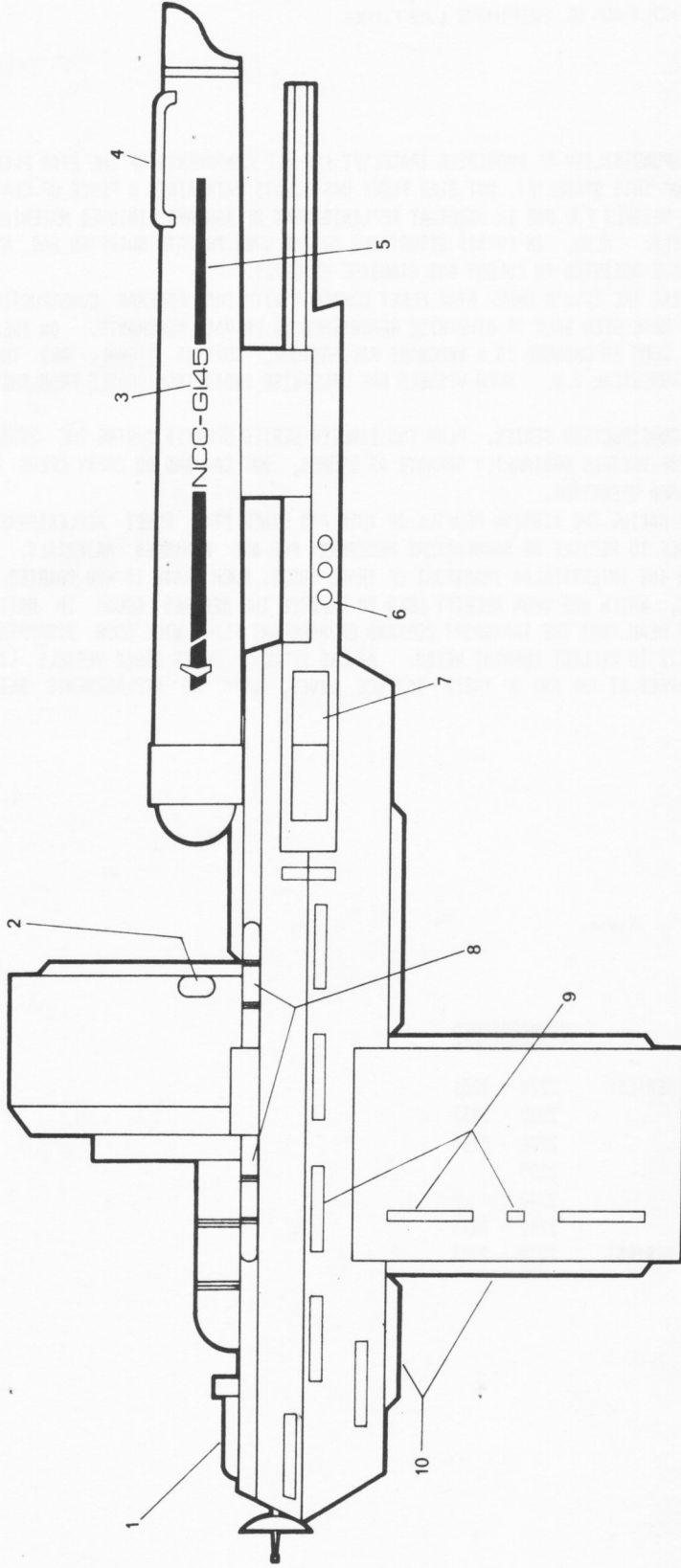

SUBFILE TWO: OUTBOARD PROFILE

RS:480371*5

TO:01:04:02:07.02

SPECIFICS:

1. SENSOR APPARATUS
2. RUNNING LIGHT-P/S
3. NUMERICAL I.D.
4. INTERCOOLERS-P/S PER UNIT
5. STAR FLEET I.D. PENNANT
6. DRY BULK CARGO DIRECT FEED-P/S
7. CARGO HOLD LOADING DOORS-P/S
8. SEARCH SENSORS & SCANNERS-P/S
9. DEFLECTOR PROJECTION PLATES
10. DOCKING LUG/AIRLOCK COVERS-6

UNITED FEDERATION OF PLANETS STAR FLEET DIVISION BUREAU OF OPERATIONS - OFFICE OF RECORDS	
GENERAL PLANS SPACECRAFT CLASS: CLASS TWO SUPPORT SPACECRAFT	
MODEL: HK-6	TYPE: CARGO VESSEL
NOMINAL CLASS: SHERMAN	
GENERATED BY: MASTERCOM SFHQ	SCALE: 1:485





STAR FLEET REFERENCE REPORT

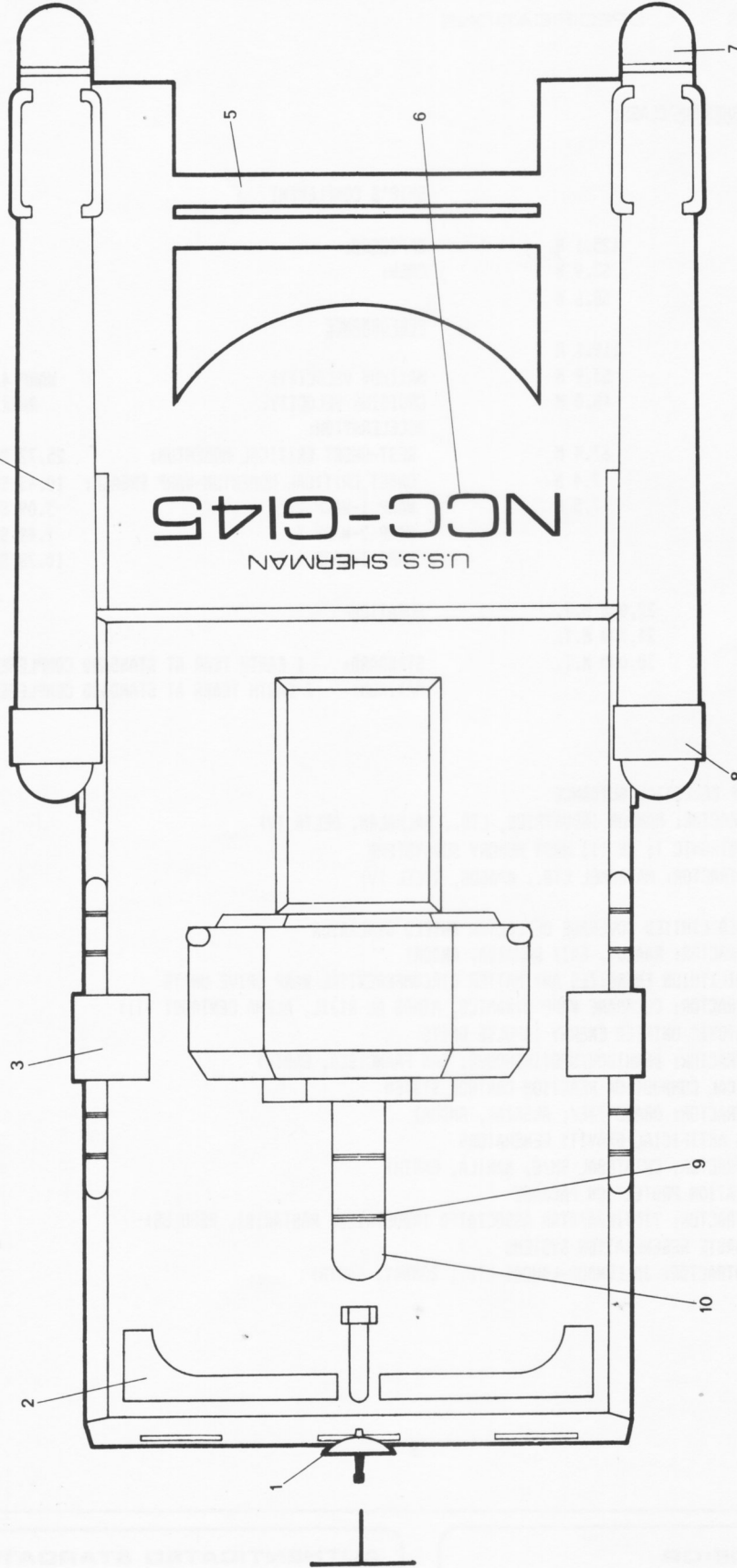

SUBFILE THREE: OUTBOARD TOP VIEW

RS: 480371*5

TO: 01:04:02:07.03

SPECIFICS:

- 1. MAIN SENSOR & NAV. DEFLECTOR
- 2. SUBSPACE RADIO ANTENNA WEB
- 3. FREIGHT LIFT HOUSING-P/S
- 4. WARP PROPULSION NACELLE-P/S
- 5. CARGO POD ATTACHMENT
- 6. NOMINAL AND NUMERIC I.D.
- 7. GENERATOR CONVL
- 8. FLUX CONSTRICTOR
- 9. DEFLECTOR GRID
- 10. BRIDGE

UNITED FEDERATION OF PLANETS
STAR FLEET DIVISION
BUREAU OF OPERATIONS - OFFICE OF RECORDS

GENERAL PLANS		SPACECRAFT CLASS:	CLASS TWO SUPPORT SPACECRAFT
MODEL:	MK-6	NOMINAL CLASS:	SHERMAN
GENERATED BY:	MASTERCORP SFHQ	SCALE:	1:485





FEDERATION SPACECRAFT

CLASS TWO MK G SPECIFICATIONS

CURRENT SPECIFICATIONS OF SHERMAN CLASS:

DIMENSIONS

OVERALL LENGTH: 125.1 M
 OVERALL DRAUGHT: 53.9 M
 OVERALL BEAM: 58.6 M

PRIMARY HULL LENGTH: 119.1 M
 PRIMARY HULL DRAUGHT: 53.9 M
 PRIMARY HULL BEAM: 48.0 M

NACELLE LENGTH: 67.4 M
 NACELLE DRAUGHT: 7.4 M
 NACELLE BEAM: 7.5 M

DISPLACEMENT

LIGHT: 22,000 M.T.
 STANDARD: 24,700 M.T.
 FULL LOAD: 30,000 M.T.

SHIP'S COMPLEMENT

OFFICERS: 3
 CREW: 10

PERFORMANCE

MAXIMUM VELOCITY: WARP 4.5
 CRUISING VELOCITY: WARP 3
 ACCELERATION:
 REST-ONSET CRITICAL MOMENTUM: 25.72 SEC
 ONSET CRITICAL MOMENTUM-WARP ENGAGE: 10.43 SEC
 WARP 1-WARP 2: 3.09 SEC
 WARP 2-WARP 3: 1.48 SEC
 WARP 3-WARP 4.5: 10.78 SEC

DURATION

STANDARD: 1 EARTH YEAR AT STANDARD COMPLEMENT
 MAXIMUM: 2 EARTH YEARS AT STANDARD COMPLEMENT

SYSTEMS

NAVIGATION: "LECTUS" WARP CELESTIAL GUIDANCE
 (SYSTEM CONTRACTOR: MANDOR INDUSTRIES, LTD., DALHALAM, DELTA IV)

COMPUTERS: "CRYSKOM" DUOTRONIC I; MK 113 MASS MEMORY SUBSYSTEMS
 (SYSTEMS CONTRACTOR: MATRAMEL LTD., APAGOS, RIGEL IV)

WEAPONS: NONE

DEFENSE: "GORTIK" FIXED LIMITED COVERAGE DEFLECTOR SHIELD GENERATOR
 (SYSTEM CONTRACTOR: RAAKUV, GAZI WAHAIDA, ANDOR)

PROPULSION: (2) PA-21C DILITHIUM ENERGIZED ANTIMATTER CIRCUMFERENTIAL WARP DRIVE UNITS
 (SYSTEM CONTRACTOR: COCHRANE WARP DYNAMICS, MINOS AL RIJIL, ALPHA CENTAURI VII)
 (2) SSB SUBATOMIC UNIFIED ENERGY IMPULSE UNITS
 (SYSTEM CONTRACTOR: DENNISON/WESTINGHOUSE, SAN FRANCISCO, EARTH)
 "IBIK" CHEMICAL COMBUSTION REACTION CONTROL SYSTEM
 (SYSTEM CONTRACTOR: DRAGE IJEK, AKSAJAK, ANDOR)

LIFE SUPPORT: (2) CT MOD 4 ARTIFICIAL GRAVITY GENERATORS
 (SYSTEM CONTRACTOR: CRISTOBAL SM/S, MANILA, EARTH)
 "KAKTI" RADIATION PROTECTION PACKAGE
 (SYSTEM CONTRACTOR: TIDJIKJA/ATAR ASSOCIATED INDUSTRIES, RASTARIBI, REGULUS)
 "SENSMA-T" WASTE REGENERATION SYSTEMS
 (SYSTEMS CONTRACTOR: JOLLUNDUR-LAHORE LTD., BOMBAY, EARTH)

RS: 480371.5

TS: 01:04:02:07.09



FEDERATION SPACECRAFT

CLASS THREE MK B/01 BACKGROUND

BACKGROUND OF "WORK BEE" CLASS:

IN THE 35 YEARS SINCE ITS INTRODUCTION, THE LOCKHEED T-4 SINGLE-OPERATOR MULTIPURPOSE CRAFT HAS BECOME THE MOST WIDELY USED SPACE VESSEL IN THE FEDERATION. IN THAT TIME, NEARLY THREE MILLION HAVE BEEN PRODUCED FOR BUYERS AS DIVERSE AS THE FURPILTI ZOOLOGICAL TRANSPORT GROUP, TRETCH-SPACEBORNE CONSTRUCTION CORPORATION, ARVAS SPACEWAYS, AND QUINTILLUS WASTE DISPOSAL. THE POPULARITY OF THE T-4 STEMS FROM ITS INCREDIBLY WIDE RANGE OF APPLICATIONS. STAR FLEET ALONE USES 17 DIFFERENT MODULAR PACKAGES WHICH ADAPT THE SPACECRAFT FOR TASKS SUCH AS HANDLING OR TOWING LARGE CARGOES, AND WELDING OR SPINNING OF METALS (USED IN PIECING OR FABRICATING SPACEBORNE HULLS). IT WAS THE PERFORMANCE OF THESE JOBS BY DOZENS OF T-4'S AROUND SPACEDOCKS THAT EARNED THEM THE NAME OF "WORK BEES", SO MUCH DID THEY RESEMBLE THE COLONIZING INSECT NATIVE TO EARTH (SUPERFAMILY APOIDEA OF THE ORDER HYMENOPTERA). THIS NAME HAS SINCE BEEN APPLIED TO MANY OF THE MODULAR VARIANTS OF THE T-4, RESULTING IN "CARGO BEES", "GRABBER BEES", "WELDER" AND "SPINNER BEES", ETC. THE "DRONE BEE", WHILE OUTWARDLY IDENTICAL TO THE STANDARD T-4, DIFFERS IN THAT IT IS FULLY AUTOMATED, AND THUS CAPABLE OF EITHER PROGRAMMED OR REMOTE-CONTROL PILOTING.

ONE RECENT ADDITION TO THE GROUP OF T-4 VARIANTS IS THE T-4 ZETA "KILLER BEE" FIGHTERCRAFT. COVERED IN GREATER DETAIL IN T.O. 01:04:03:02.41, THE "KILLER BEE" COMBINES AN EXTENSIVELY MODIFIED WORK BEE WITH A SINGLE, SKATE-LIKE IMPULSE ENGINE / HYPERSPACE INJECTOR ATTACHED TO A WEAPONS PACKAGE. WHILE AN UNLIKELY COMBINATION, THIS HAS PROVED TO BE AN EXTRAORDINARILY EFFECTIVE FIGHTER-- AN EVENT OWING MORE THAN ANYTHING TO ITS ABILITY TO SLIP INTO HYPERSPACE JUST LONG ENOUGH TO GET THROUGH AN ENEMY'S DEFLECTOR SCREENS.

ON THE WHOLE, HOWEVER, THE VAST MAJORITY OF WORK BEES ARE EMPLOYED IN FAR LESS ADVENTURESOME-- THOUGH EQUALLY NECESSARY-- TASKS IN AND AROUND STAR FLEET CONSTRUCTION AND MAINTENANCE FACILITIES. FURTHERMORE, ALL CLASS ONE STARSHIPS ARE OUTFITTED WITH A NUMBER OF THE CRAFT FOR REPAIR AND TRANSPORT PURPOSES. EASY TO LEARN TO OPERATE (THEY ARE CONTROLLED BY A SIMPLE ATTITUDE AND THRUST STICK), THEY ARE REPORTEDLY ALSO A JOY TO PILOT. MOST OPERATORS REMOVE THE GRAV-PLATES BEFORE BEGINNING THEIR SHIFTS IN ORDER TO ENJOY THE FREEDOM OF A ZERO-G, SHIRT-SLEEVE ENVIRONMENT. CONSIDERING ITS MANY USES AND OBVIOUS POPULARITY, THEN, IT IS LIKELY THE WORK BEE WILL BE WITH US FOR SOME TIME. IT WOULD CERTAINLY BE DIFFICULT TO COME UP WITH A MORE VERSATILE DESIGN TO REPLACE IT.

FOR INFORMATION ON THE MODULAR VARIANTS OF THE T-4 "WORK BEE", CONSULT:

- T.O. 01:04:03:02.01 FOR T-4 ALPHA "DRONE BEE" (MODEL MK B/01 A)
- T.O. 01:04:03:02.11 FOR T-4 BETA "GRABBER BEE" (MODEL MK B/02)
- T.O. 01:04:03:02.21 FOR T-4 GAMMA "WELDER BEE" (MODEL MK B/03)
- T.O. 01:04:03:02.21 FOR T-4 DELTA "SPINNER BEE" (MODEL MK B/03 A)
- T.O. 01:04:03:02.31 FOR T-4 EPSILON "CARGO BEE" (MODEL MK B/04)
- T.O. 01:04:03:02.41 FOR T-4 ZETA "KILLER BEE" (MODEL MK B/05)

RS: 480371.4

TO: 01:04:03:02.01



STAR FLEET REFERENCE REPORT

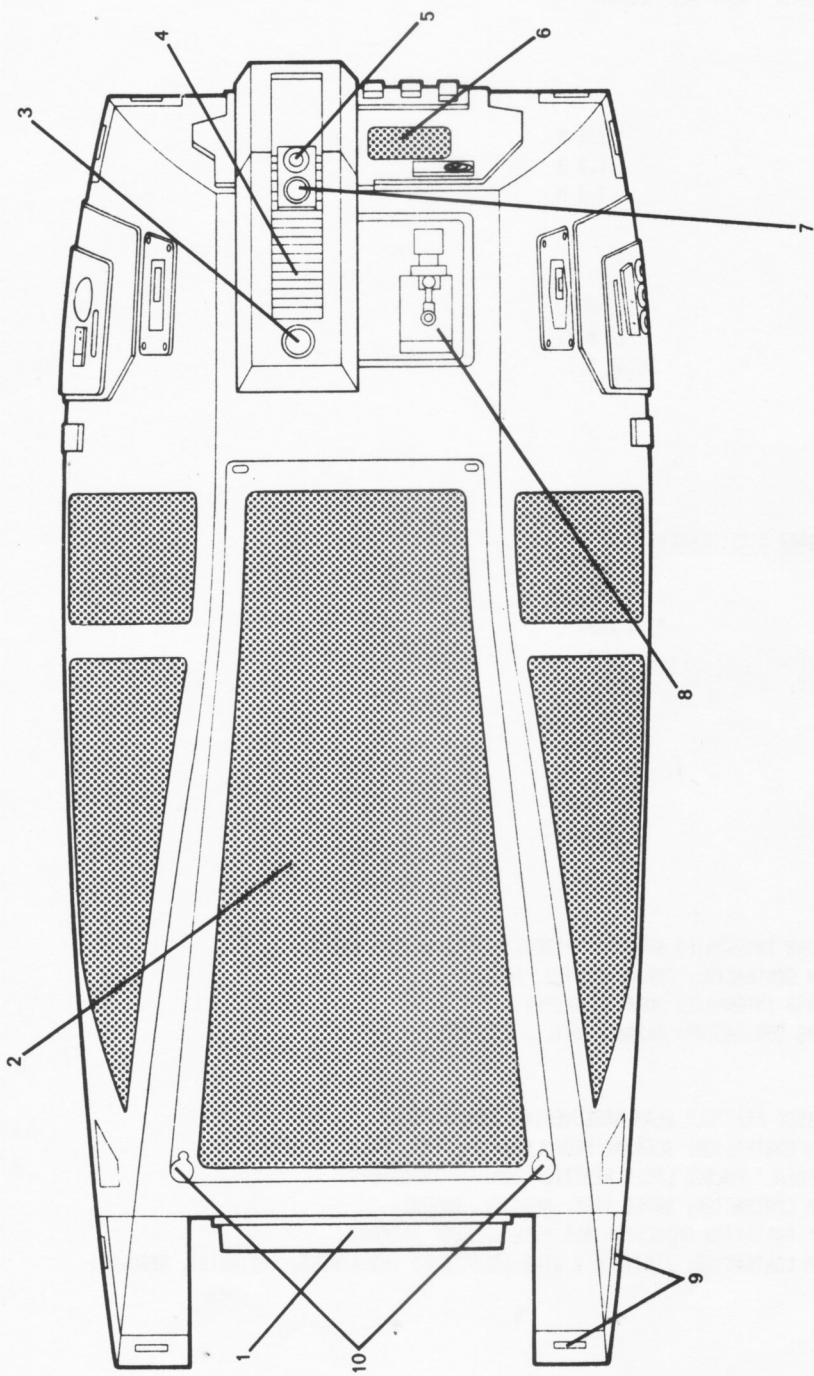

SUBFILE THREE: OUTBOARD TOP VIEW

RS:480371-4

TO:01:04:03:02.03

SPECIFICS:

- 1. FORWARD ILLUMINATOR
- 2. VIEWING PORT (B)
- 3. NAVIGATION BEACON
- 4. VENTILATION SYSTEM
- 5. FUEL RECHARGER INSERT
- 6. REAR PORT
- 7. POWER RECHARGER INSERT
- 8. COMMUNICATIONS SYSTEM
- 9. REACTION CONTROL THRUSTERS
- 10. EXPLOSIVE BOLTS

UNITED FEDERATION OF PLANETS		SPACECRAFT CLASS:		SCALE: 1:14.2
STAR FLEET DIVISION		CLASS THREE SMALL SPACECRAFT		
BUREAU OF OPERATIONS - OFFICE OF RECORDS		NOMINAL CLASS:		
GENERAL PLANS		MULTIPURPOSE CRAFT		
MODEL: MK-8/01		"WORK BEE"		
GENERATED BY:		MASTERCOM SFHQ		



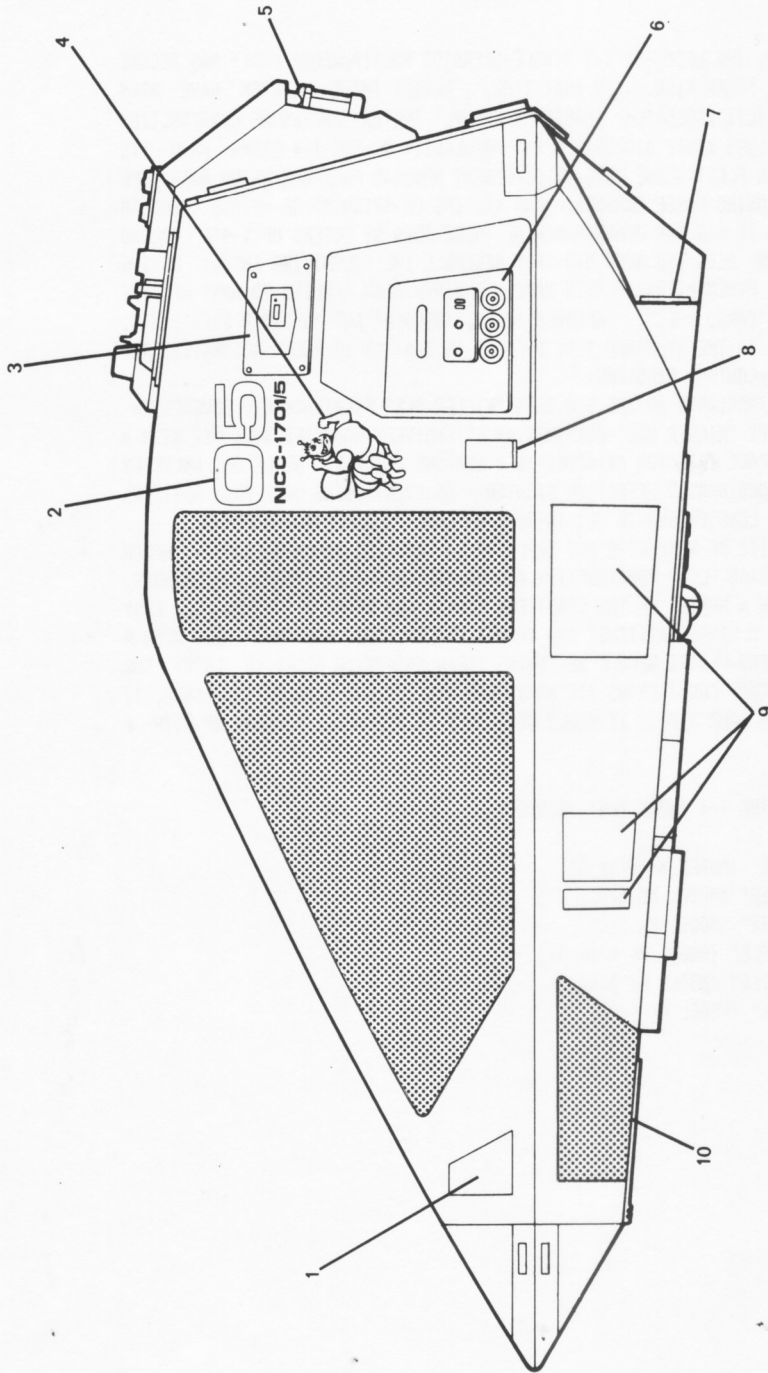

SUBFILE TWO: OUTBOARD PROFILE

RS:480371-4

TO:01:04:03:02.02

SPECIFICS:

- 1. DOCKING POINTS-P/S
- 2. NUMERICAL I.D.
- 3. SYSTEMS MONITOR ACCESS
- 4. "WORK BEE" EMBLEM
- 5. MAIN GENERATOR
- 6. LIFE SUPPORT EQUIPMENT ACCESS
- 7. MANEUVERING THRUSTER-P/S
- 8. RUNNING LIGHT-P/S
- 9. MODULE ATTACHMENT AREAS-P/S
- 10. UNDERSIDE VIEWING PORT-P/S

UNITED FEDERATION OF PLANETS
STAR FLEET DIVISION
 BUREAU OF OPERATIONS - OFFICE OF RECORDS

GENERAL PLANS	SPACECRAFT CLASS:	CLASS THREE SMALL SPACECRAFT
MODEL:	TYPE:	NOMINAL CLASS:
HK-B/01	MULTIPURPOSE CRAFT	"WORK BEE"
GENERATED BY:	SCALE:	1:14.2
MASTERCAM SFHQ		





FEDERATION SPACECRAFT

CLASS THREE · MK B/01 SPECIFICATIONS

CURRENT SPECIFICATIONS OF "WORK BEE" CLASS:

DIMENSIONS

OVERALL LENGTH:	2.7 M
OVERALL DRAUGHT:	1.2 M
OVERALL BEAM:	1.3 M

DISPLACEMENT

LIGHT:	2.12 M.T.
STANDARD:	2.23 M.T.
FULL LOAD	35.68 M.T.

CREW

ONE

PERFORMANCE (AT STANDARD DISPLACEMENT)

MAXIMUM VELOCITY:	8.21 KM/SEC
CRUISING VELOCITY:	7.91 KM/SEC
ACCELERATION:	
REST-MAXIMUM VELOCITY:	12.40 SEC

DURATION

STANDARD:	6 HOURS
MAXIMUM:	24 HOURS

SYSTEMS

NAVIGATION: 12-K 1248 INTEGRATED SUPPORT SYSTEM; 1248-I NAVCOM ADD-ON
(SYSTEM CONTRACTOR: AKRAS, GENILI, EARTH)

COMPUTER: 12-K 1248 INTEGRATED SUPPORT SYSTEM
(SYSTEMS CONTRACTOR: AKRAS, GENILI, EARTH)

WEAPONS: NONE

DEFENSE: NONE

PROPULSION: (2) M-1020 PARTICLE BEAM MANEUVERING THRUSTERS
(SYSTEM CONTRACTOR: SCARBAK PROPULSION SYSTEMS, CAIRO, EARTH)
(32) "HOKAL" PULSED LASER REACTION CONTROL THRUSTERS
(SYSTEM CONTRACTOR: DRAGE IJEK, AKSAJAK, ANDOR)

LIFE SUPPORT: "LAR'L" RADIATION SHIELDING AND LIFE SUPPORT PACKAGE
(SYSTEM CONTRACTOR: TIDJIKJA / ATAR ASSOCIATED INDUSTRIES, RASTARIBI, REGULUS)

RS: 480371.4

TO:01:04:03:02.09



FEDERATION SPACECRAFT

CLASS THREE MK B/03 BACKGROUND & PERSPECTIVE VIEW

BACKGROUND OF "WELDER BEE" AND "SPINNER BEE" CLASSES:

DESIGNED UNDER STAR FLEET CONTRACT, THESE MODULAR VARIANTS OF THE STANDARD T-4 "WORK BEE" ARE USED IN SPACEBORNE PIECING AND FABRICATION OPERATIONS. AS PICTURED BELOW, THE SPACECRAFT USES A 10.20 MEV PHASER TORCH TO WELD PREFABRICATED PARTS SUCH AS HULL SHEETING, STRUCTURAL FRAMEWORK, ETC. USING A DIFFERENT TIP, AND SYNTHESIZING UNITS INSTEAD OF THE ENERGY BOTTLES SHOWN, THE CRAFT CAN SPIN METALS LIKE TRITITANIUM FOR USE IN STARSHIP OUTER HULLS. FINALLY, ALSO USING THE SPINNER MECHANISM, ADHESIVES USED IN HULL BONDING (SUCH AS GRAPHX AND AFRALON) CAN BE INJECTED.

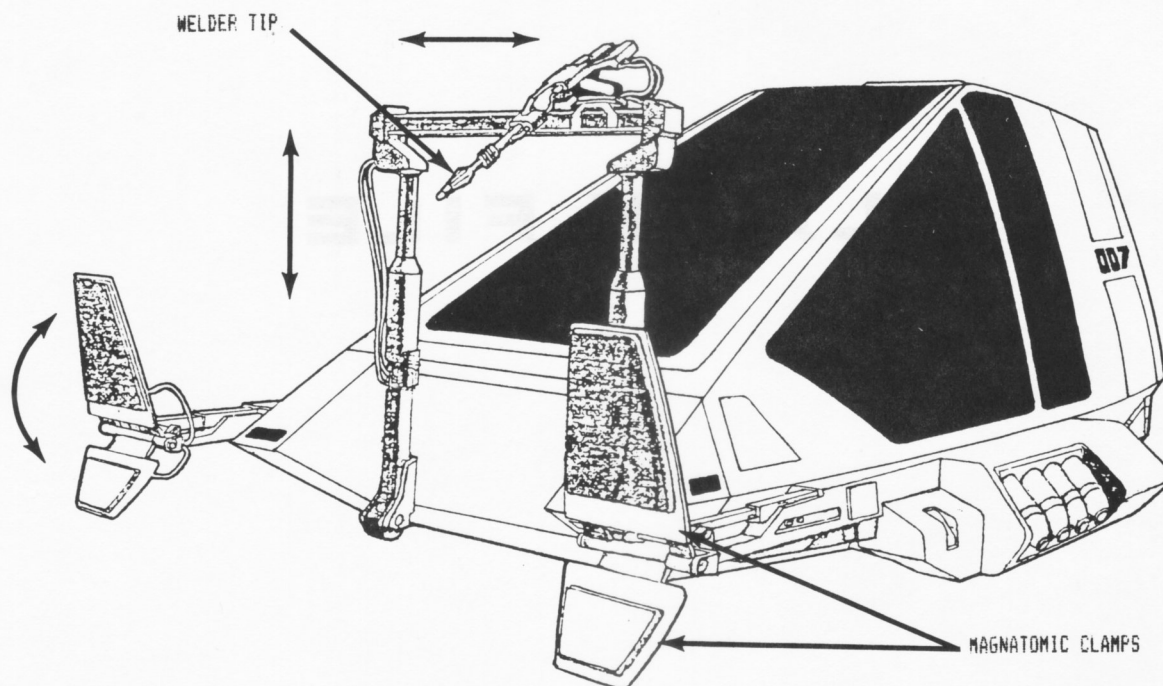

RS: 480371.4

TO: 01:04:03:02.38



FEDERATION SPACECRAFT

CLASS THREE MK B/02 DETAILS: PERSPECTIVE VIEWS

.75 FORE

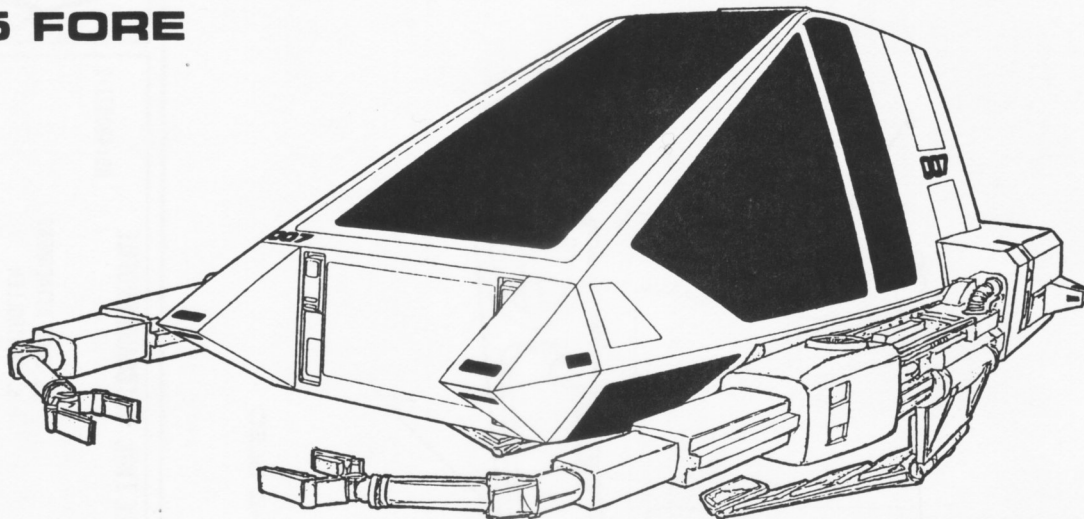

.75 AFT

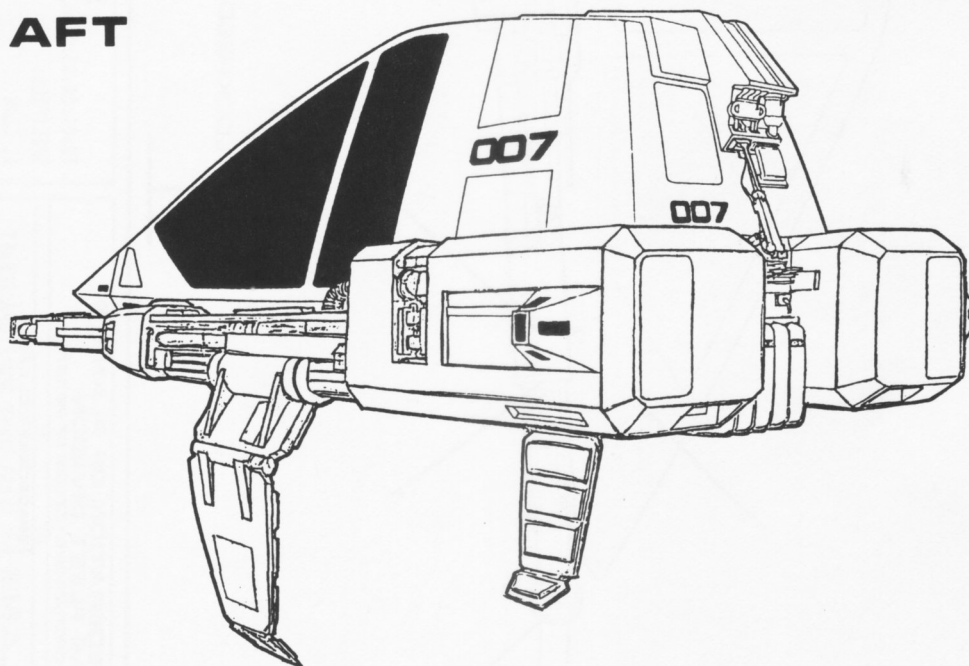

LOCKHEED T4-B SLED

RS: 480371.2

TO: 01:04:03:04.01

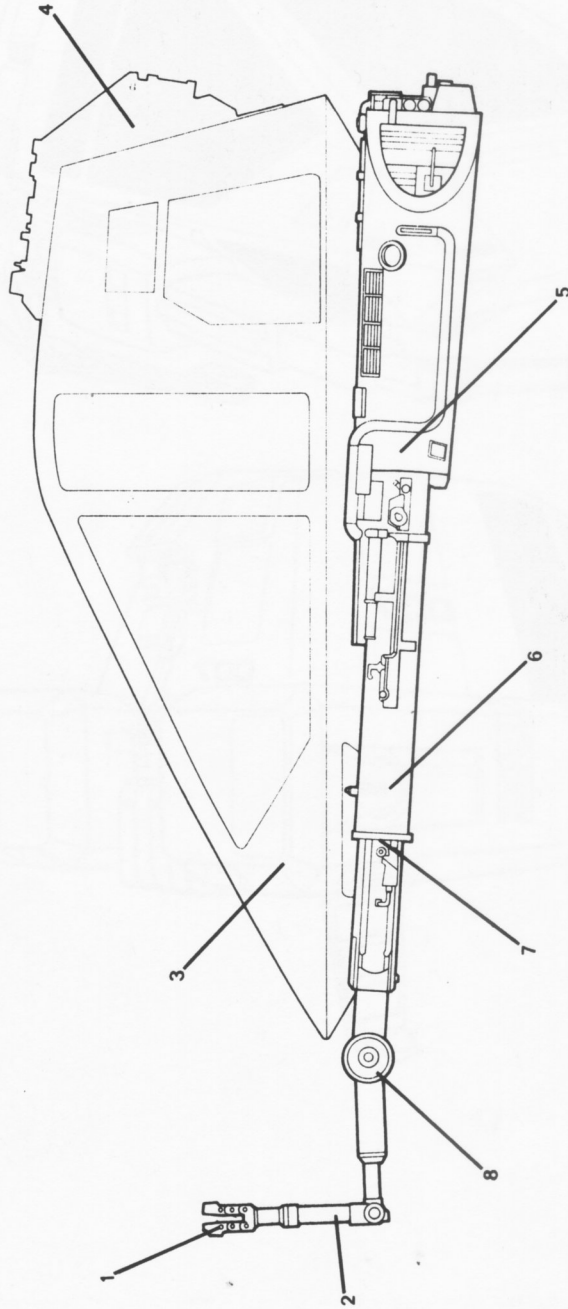

LOCKHEED T4-A SLED

UNITED FEDERATION OF PLANETS
STAR FLEET DIVISION
BUREAU OF OPERATIONS - OFFICE OF RECORDS

GENERAL PLANS	SPACECRAFT CLASS:	CLASS THREE SMALL SPACECRAFT
MODEL: MK-8/02	TYPE:	MULTI-PURPOSE CRAFT
GENERATED BY: MASTERCOM SFHQ	NOMINAL CLASS:	GRABBER BEE
	SCALE:	1:19

SUBFILE TWO: OUTBOARD PROFILE

RS:480371*2

TO:01:04:03:04.02

SPECIFICS:

- 1. CLAW
- 2. FOREARM
- 3. WORK BEE
- 4. LIFE SUPPORT PACKAGE
- 5. SLED ATTACHMENT
- 6. CONTROLLER
- 7. EXTENDER
- 8. SHOULDER JOINT





FEDERATION SPACECRAFT

CLASS THREE MK E/02 BACKGROUND

BACKGROUND OF "WARP-DRIVEN SHUTTLE" CLASS:

IN 2264 FARADAY INDUSTRIES PRESENTED STAR FLEET WITH PROTOTYPES OF THE "TANDEM" EIGHT AND FOURTEEN PERSON SHUTTLES. SINCE THAT TIME A NUMBER OF VERSIONS OF THE SHUTTLES EMPLOYING VARIOUS PACKAGE COMBINATIONS HAVE BEEN COMMISSIONED. ONE OF THE FIRST SUCH VERSIONS WAS THE WARP/IMPULSE PROPELLED "TANDEM" 14, IN 2265.

THE SHUTTLECRAFT WARPSLED DESIGN FOR THE "TANDEM" 14 WAS MADE POSSIBLE BY DISCOVERIES MADE DURING THE PROPULSION RESEARCH THAT LED TO THE DEVELOPMENT OF LINEAR WARP DRIVE. ONE OFFSHOOT WAS THE DEVELOPMENT OF LOW-YIELD WARP GENERATORS OF SUCH SMALL SIZE THAT WARP AND IMPULSE PROPULSION UNITS COULD BE COMBINED IN ONE HOUSING. THE WARP FIELD NEEDED FROM THE ENGINES WAS SMALL ENOUGH TO ALLOW VERY LIMITED ANTIMATTER STORES THAT COULD LIKEWISE BE CONTAINED IN THE NACELLES. THE RESULT WAS A VERY SPARTAN, STREAMLINED PROPULSION SLED THAT COULD REMAIN WITH ITS ATTACHED SHUTTLE DURING TAKEOFF, REENTRY, AND LANDING.

THE ENTIRE LINE OF "TANDEM" SHUTTLE VERSIONS WAS DEVELOPED UNDER STAR FLEET CONTRACT. THE WARP/IMPULSE PROPELLED "TANDEM" 14 IS STATIONED AT ALL STAR FLEET SHORE ESTABLISHMENTS AND ABOARD SOME LARGE FLEET VESSELS. EARLY APPROVAL WAS ALSO GIVEN FOR THE OPERATION OF UNARMED VERSIONS FROM SPACEPORTS BY PRIVATE SPACELINES, AND MANY HAVE BEEN PURCHASED FOR THIS PURPOSE. THESE CAN BE DISTINGUISHED BY THE ABSENCE OF THE STAR FLEET STANDARD DOCKING RING AT THE SHUTTLECRAFT STERN. THEY FURTHERMORE BROADCAST AND CARRY A COMMERCIAL CARRIER NUMBER INSTEAD OF A NAVIGATIONAL CONTACT CODE.

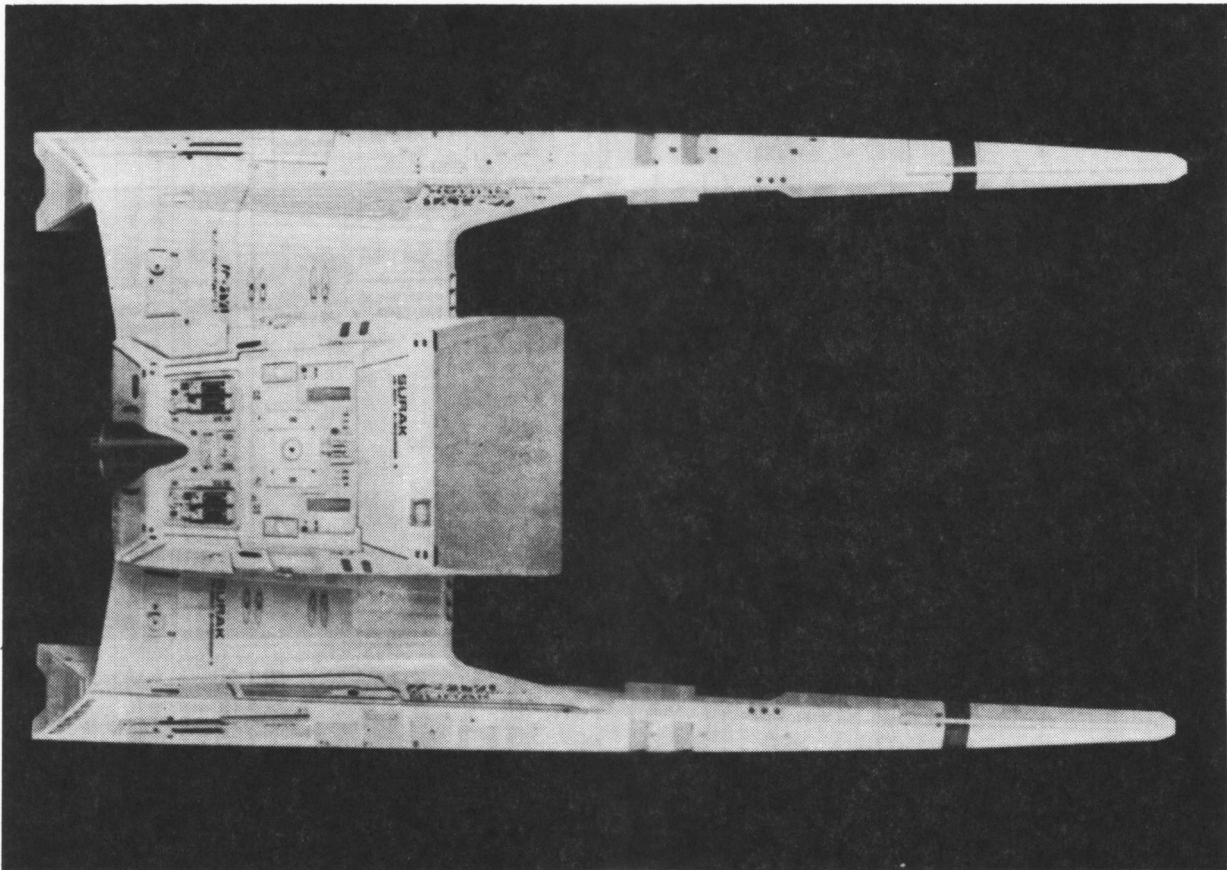

RS: 480371.6

TO: 01:04:03:05.11

AUTHENTICATED STARDATE 7904.87

AMENDMENT CODE:OR

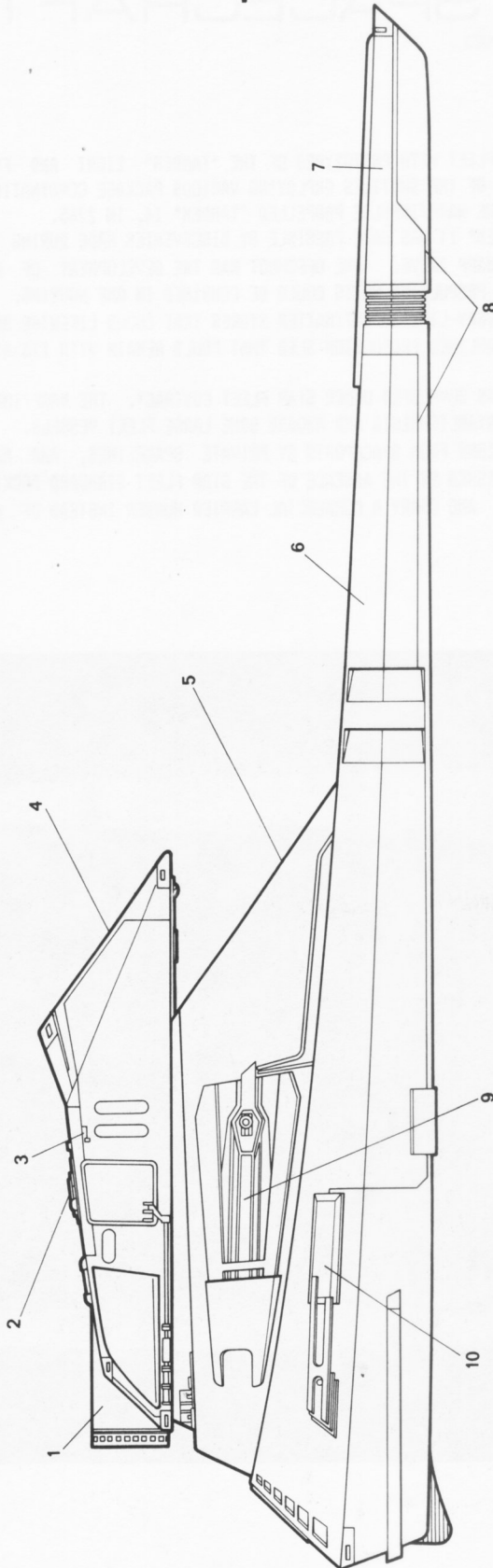

SUBFILE TWO: OUTBOARD PROFILE

RS: 480371-6
 TO: 01:04:03:05.12
 SPECIFICS:
 1. DOCKING RING
 2. EMERGENCY HATCH-1/8
 3. TELEMETERS-P/S
 4. SHUTTLE
 5. PROPULSION SLED
 6. WARP PROPULSION NACELLE-P/S
 7. INLET FLOW SENSOR-P/S
 8. TELEMETRY GRID-P/S
 9. SPACE ENERGY FIELD SENSOR-P/S
 10. INTERCOOLER-P/S

UNITED FEDERATION OF PLANETS
 STAR FLEET DIVISION
 BUREAU OF OPERATIONS - OFFICE OF RECORDS

GENERAL PLANS	SPACECRAFT CLASS: CLASS THREE SMALL SPACECRAFT
MODEL: HK-E/02	NOMINAL CLASS: "WARP DRIVEN SHUTTLE"
GENERATED BY: MASTERCORP SFHQ	SCALE: 1:200





STAR FLEET REFERENCE REPORT

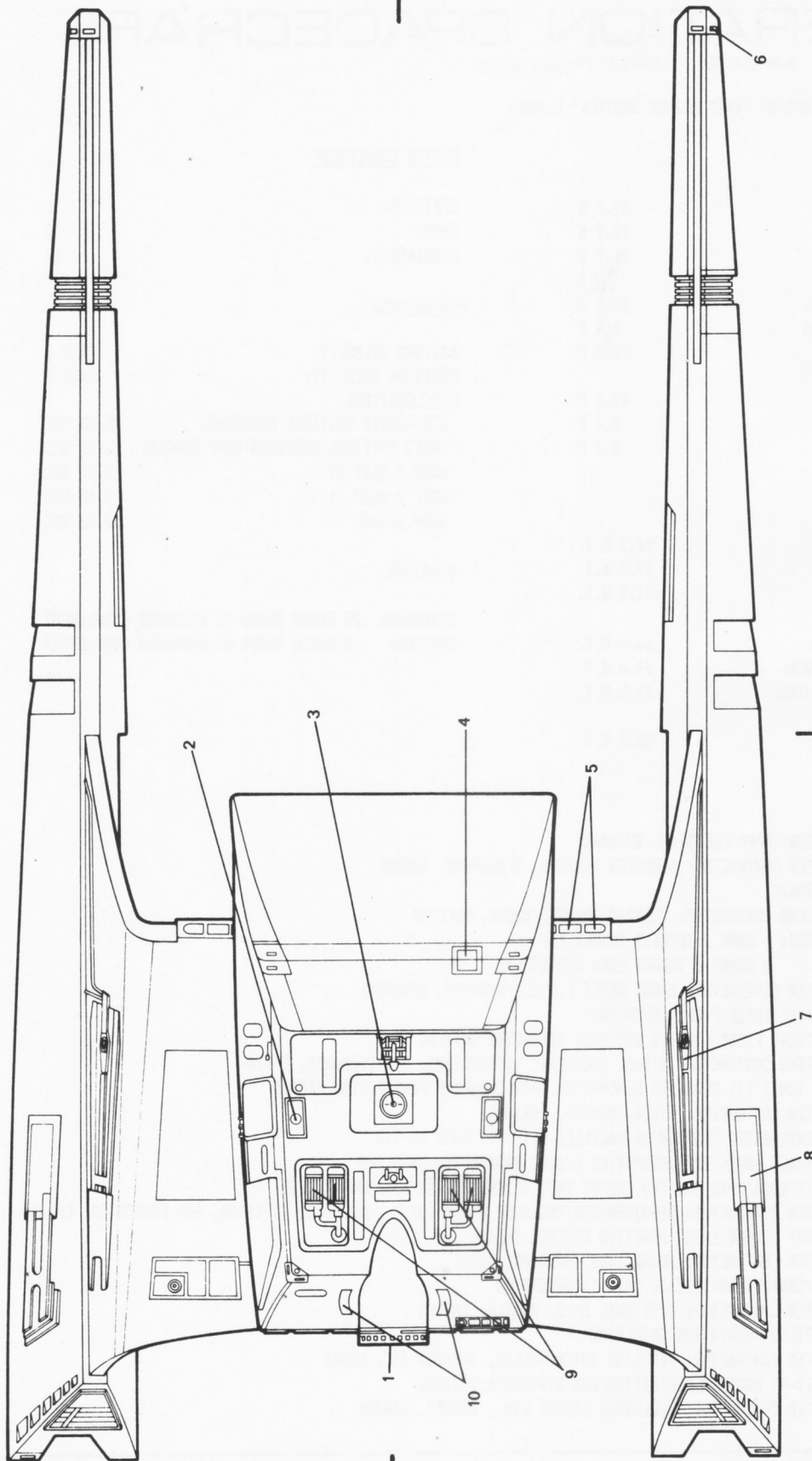

SUBFILE THREE: OUTBOARD TOP VIEW

RS: 480371-6

TO: 01:04:03:05.13

SPECIFICS:

- 1. DOCKING RING
- 2. TOPSIDE PHASER TURRET (2)
- 3. EMERGENCY HATCH-T/8
- 4. VISUAL LOCATION BEACON
- 5. EMERGENCY FLUSH INTAKE-P/S
- 6. REACTION CONTROL THRUSTER
- 7. SPACE ENERGY FIELD SENSOR-P/S
- 8. INTERCOOLER-P/S
- 9. LIFE SUPPORT APPARATUS
- 10. DOCKING LIGHTS

UNITED FEDERATION OF PLANETS
 STAR FLEET DIVISION
 BUREAU OF OPERATIONS - OFFICE OF RECORDS

SPACECRAFT CLASS: CLASS THREE SMALL SPACECRAFT

MODEL: MK-E/02

GENERAL PLANS

TYPE: GENERAL TRANSPORT 4

NOMINAL CLASS: "HAPP DRIVEN SHUTTLE"

SCALE: 1:200

GENERATED BY: MASTERCOM SFHG





FEDERATION SPACECRAFT

CLASS THREE MKE/02 SPECIFICATIONS

CURRENT SPECIFICATIONS OF "WARP DRIVEN SHUTTLE" CLASS :

DIMENSIONS

OVERALL LENGTH: 49.7 M
 OVERALL DRAUGHT: 12.9 M
 OVERALL BEAM: 26.7 M

SHUTTLECRAFT LENGTH: 18.7 M
 SHUTTLECRAFT DRAUGHT: 4.4 M
 SHUTTLECRAFT BEAM: 11.1 M

NACELLE LENGTH: 49.7 M
 NACELLE DRAUGHT: 6.4 M
 NACELLE BEAM: 4.3 M

DISPLACEMENT

OVERALL LIGHT: 94.2 M.T.
 OVERALL STANDARD: 97.7 M.T.
 OVERALL FULL LOAD: 101.2 M.T.

SHUTTLECRAFT LIGHT: 30.5 M.T.
 SHUTTLECRAFT STANDARD: 34.0 M.T.
 SHUTTLECRAFT FULL LOAD: 37.5 M.T.

WARP SLED STANDARD: 63.7 M.T.

SHIP'S COMPLEMENT

OFFICERS: 1
 CREW: 3
 PASSENGERS: 10

PERFORMANCE

MAXIMUM VELOCITY: WARP 4
 CRUISING VELOCITY: WARP 2
 ACCELERATION:
 REST-ONSET CRITICAL MOMENTUM: 25.63 SEC
 ONSET CRITICAL MOMENTUM-WARP ENGAGE: 3.30 SEC
 WARP 1-WARP 2: 3.76 SEC
 WARP 2-WARP 3: 5.65 SEC
 WARP 3-WARP 4: 13.58 SEC

DURATION

STANDARD: .25 EARTH YEARS AT STANDARD COMPLEMENT
 MAXIMUM: 2 EARTH YEARS AT STANDARD COMPLEMENT

SYSTEMS

NAVIGATION: "FALCON" WARP CELESTIAL GUIDANCE
 (SYSTEM CONTRACTOR: BENKULEN SYSTEMS, SINGAPORE, EARTH)

COMPUTERS: "T'PRARIK"
 (SYSTEMS CONTRACTOR: SHAKTIR TRIPEL, SURAK, VULCAN)

WEAPONS: PHASERS: 1 BANK 2 TURRETS MENOKT LTF
 2 BANKS 1 TURRET EACH MENOKT LTC
 (SYSTEM CONTRACTOR: RACAL WERFT F.M.C., STRATOS, ARDANKA)

DEFENSE: "LORICA" FORCE FIELD GENERATOR
 "ELYTRON" FIXED LIMITED COVERAGE DEFLECTOR SHIELDS
 (SYSTEMS CONTRACTOR: SIGNAL ELECTRONIC ENTERPRISES, MEDITERRANEA, EARTH)
 CGCP (UNIT II) CLOAKING GENERATION AND CLOAKING PENETRATION SYSTEM
 (SYSTEM CONTRACTOR: HYCOR, WOBURN, EARTH)

PROPULSION: (2) INTEGRATED PROPULSION NACELLES WITH (1) EACH LS-IIB
 DILITHIUM ENERGIZED ANTIMATTER LINEAR WARP DRIVE UNIT AND
 RM-IIB SUBATOMIC UNIFIED ENERGY IMPULSE ENGINE, ON DETACHABLE SLED
 (SYSTEM CONTRACTOR: DENNISON/WESTINGHOUSE HYPERPHOTIC PROPULSION DIVISION, SAN FRANCISCO, EARTH)
 "SISAK" PULSED LASER REACTION CONTROL SYSTEM
 (SYSTEM CONTRACTOR: DRAGE IJEK, AKSAJAK, ANDOR)

LIFE SUPPORT: CA-4/CENTRIS ARTIFICIAL GRAVITY GENERATOR
 (SYSTEM CONTRACTOR: CRISTOBAL SM/S, MANILA, EARTH)
 "NAUTILUS" RADIATION SHIELDING
 (SYSTEM CONTRACTOR: PERIDIUM INTERSTELLAR, TRANQUILITY, LUNA)
 "CERIX-B" WASTE REGENERATION AND SYNTHESIS SYSTEMS
 (SYSTEM CONTRACTOR: JULLUJDUR-LAHORE LTD., BOMBAY, EARTH)

RS: 480371.6

TO:01:04:03:05.19



PHASER

AGRONSKA 3Q HAND/PISTOL COMBINATION

HAND PHASER

- 1. 1.02 MEV PHOTON EMITTER
- 2. ELECTRON ASPIRATOR PILE
- 3. TRIGGER
- 4. FORCE INDICATOR DIAL
- 5. OPERATIONAL LIGHT (BLUE)
- 6. FORCE SETTING WHEEL
- 7. FACE PLATE
- 8. BODY SHELL
- 9. DEFLECTOR SHIELD
- 10. ACCESS PLATE

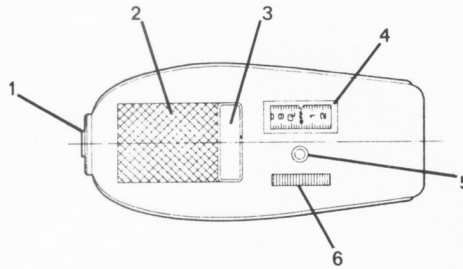

PISTOL PHASER (REQUIRES HAND PHASER CLIP-ON)

- 11. LOCK RELEASE
- 12. BODY SHELL
- 13. DEFLECTOR SHIELD
- 14. REAR LOCK PLATE
- 15. FORCE SETTING DIAL
- 16. MAGNATOMIC ADHESION AREAS
- 17. GRIP
- 18. DILITHIUM CRYSTAL CELL
- 19. BEAM EMITTER
- 20. BEAM SHIELD
- 21. ENERGY FOCALIZER
- 22. TRIGGERS (TOP--SAFETY, BOTTOM--FIRE)

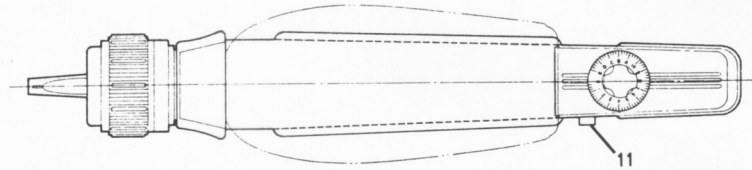

TOP

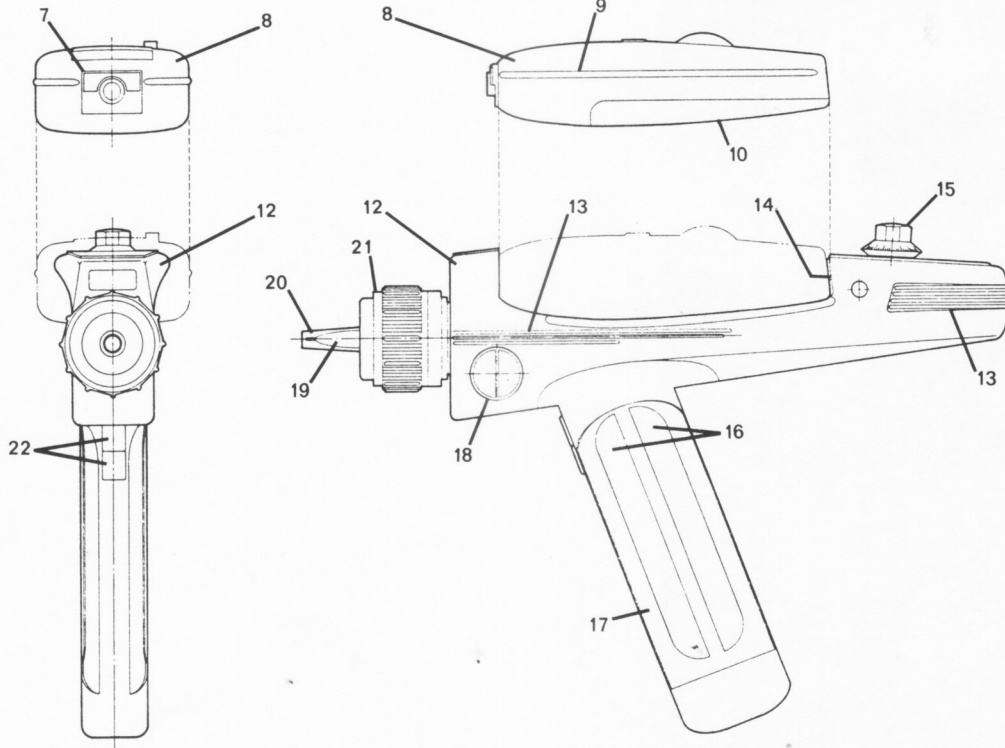

FRONT

SIDE

RS: 480371.2

TO: 01:08:50:24.01



PHASER

HAND/PISTOL COMBINATION-MARFAK "STING" MODEL ONE

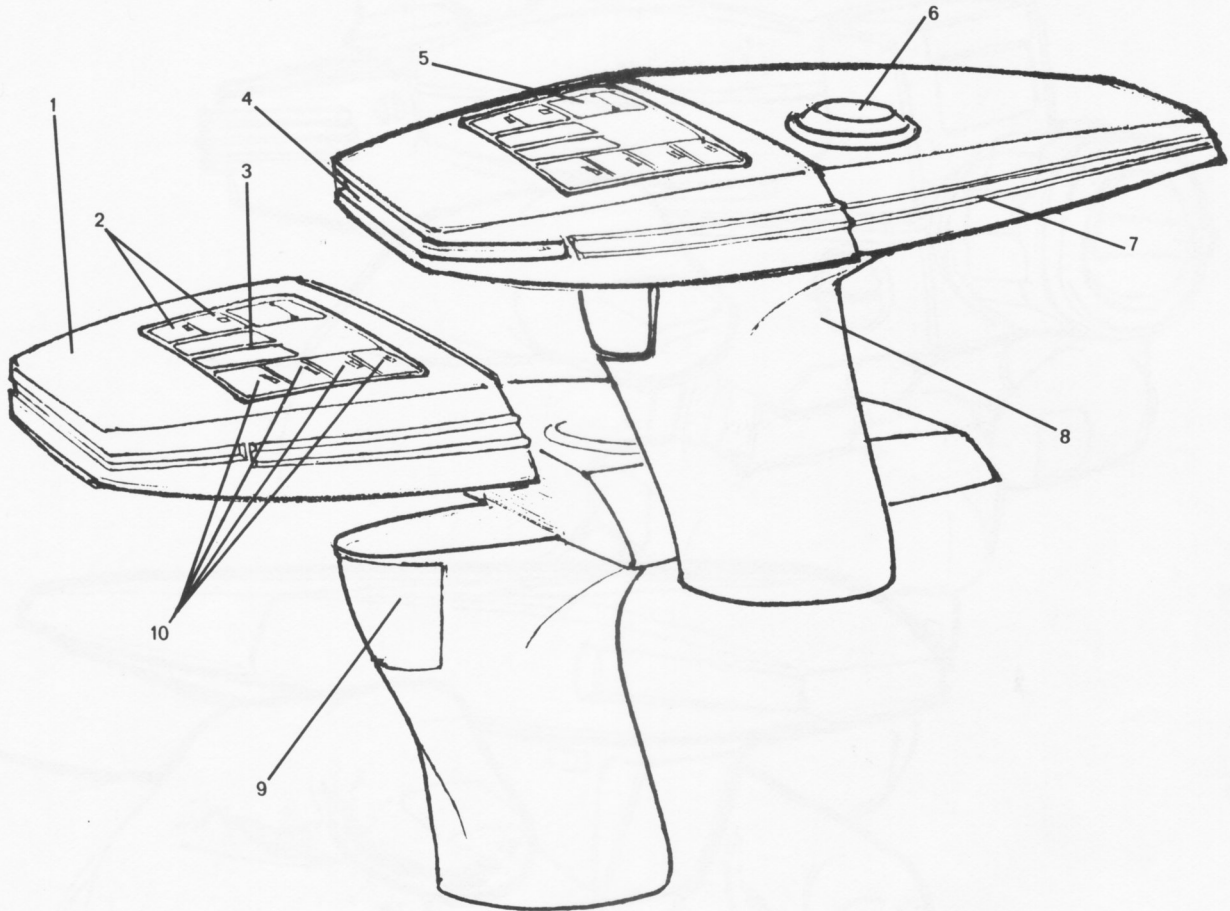

MARFAK "STING" MODEL ONE
CONTRACT NO. SFD/ORD 692739a
CONTRACTOR: MARFAK ARMAMENTS, OK-TAIV IKS, ANDOR

SPECIFICS:

- | | |
|----------------------------|--------------------------|
| 1. HAND PHASER (LOCKS ON) | 8. GRIP |
| 2. BEAM CONTROL (HIGH/LOW) | 9. PISTOL PHASER TRIGGER |
| 3. HAND PHASER TRIGGER | 10. INTENSITIES: |
| 4. BEAM EMITTER | A. STUN |
| 5. POWER LEVEL INDICATOR | B. HEAT |
| 6. DILITHIUM CRYSTAL CELL | C. DISRUPT |
| 7. DEFLECTOR SHIELD | D. DEMATERIALIZER |

RS: 480371.1

TO: 01:08:50:99.24



PHASERS

HAND/PISTOL COMBINATIONS-AGRONSKA 30 & MARFAK "STING" MODEL TWO

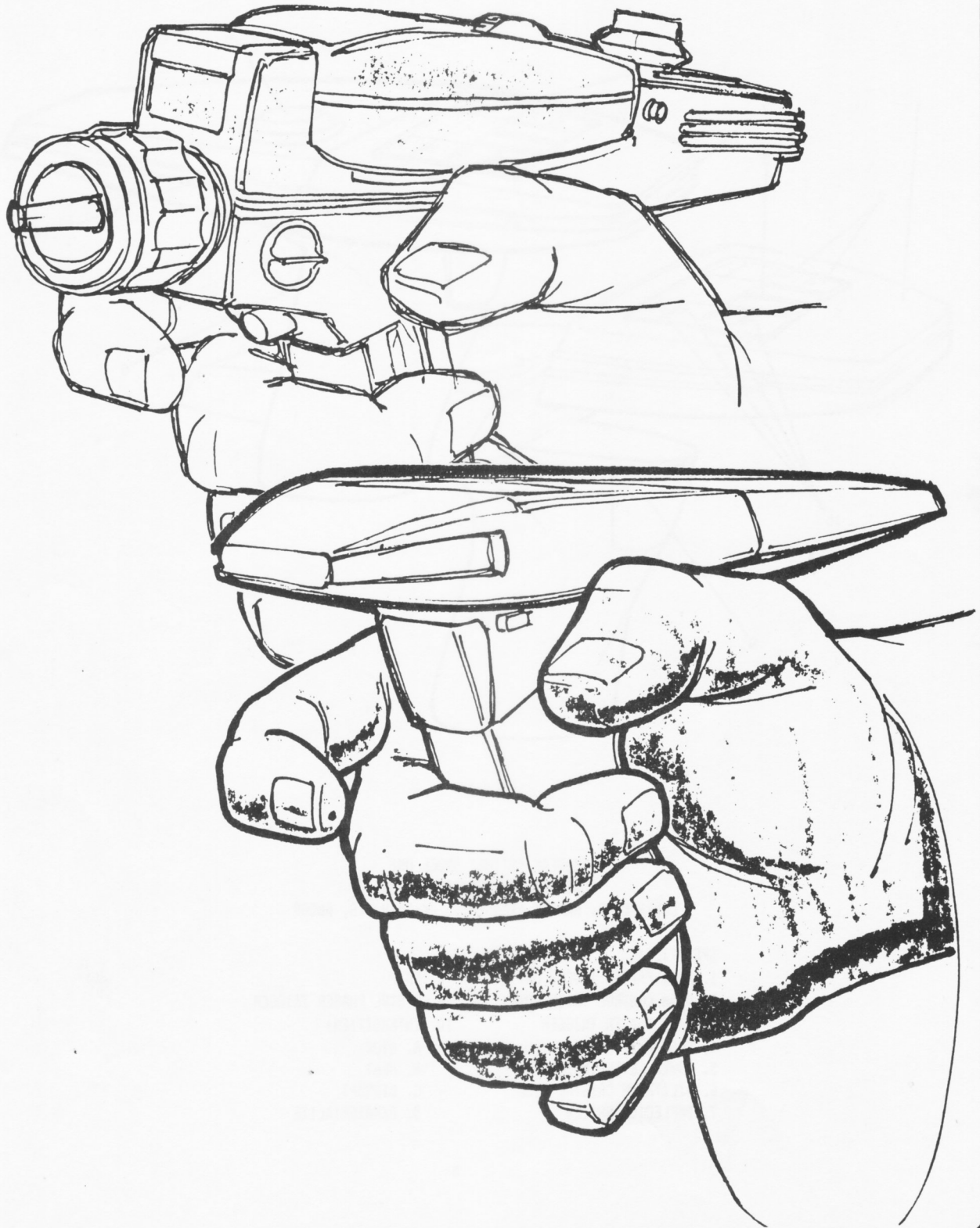

RS: 480371.1

TO: 01:08:50:99.25

AMENDMENT CODE:OR

AUTHENTICATED STARDATE 8408.30



RECREATION LOUNGE

PHASE II PROGRAM - CLASS I STARSHIPS ARTIST'S PROPOSAL

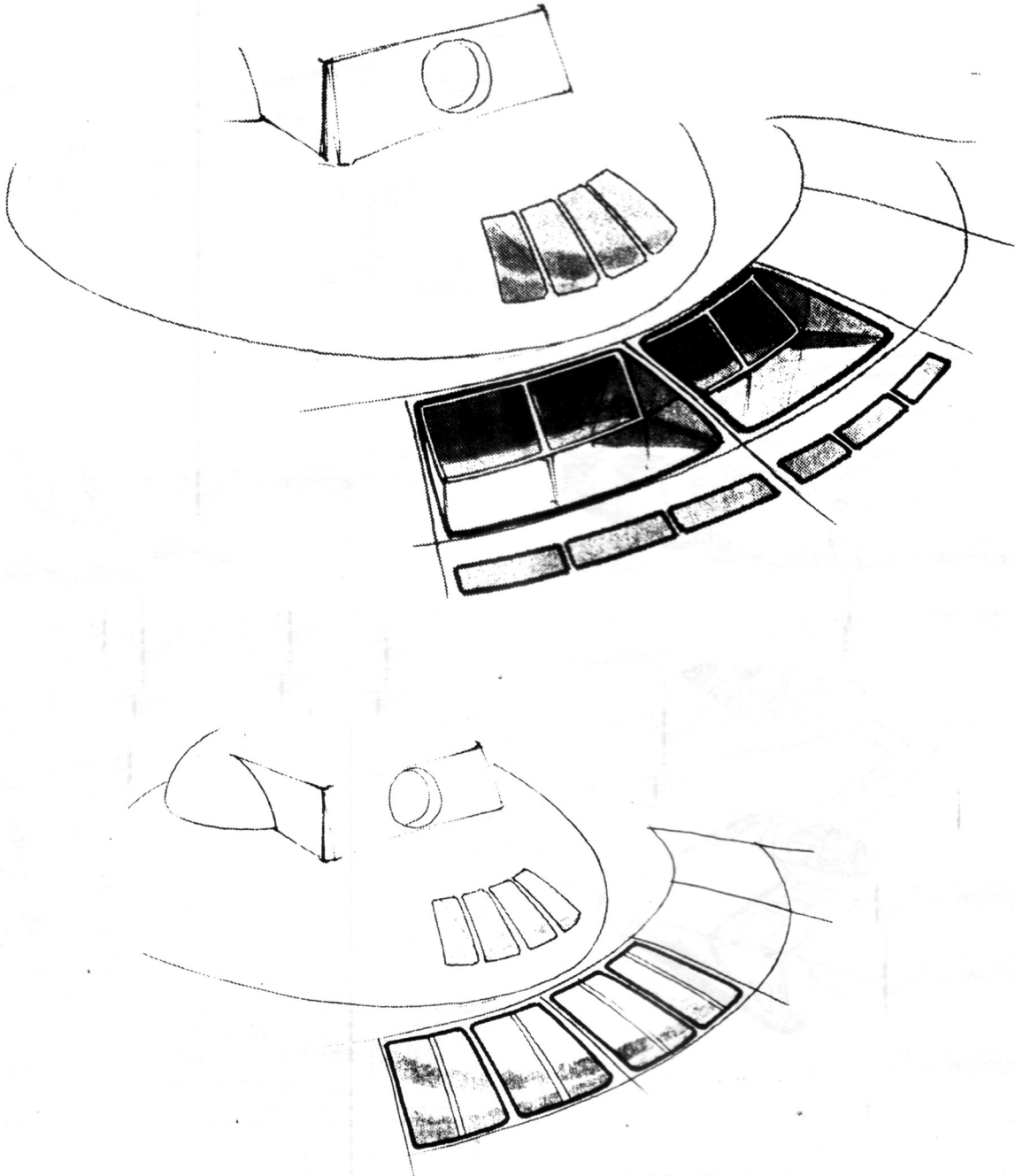

RS:480381

TO:01:04:01:48.50



FEDERATION STARSHIP

CLASS ONE MK IX/05 OFFICERS' LOUNGE CUTAWAY

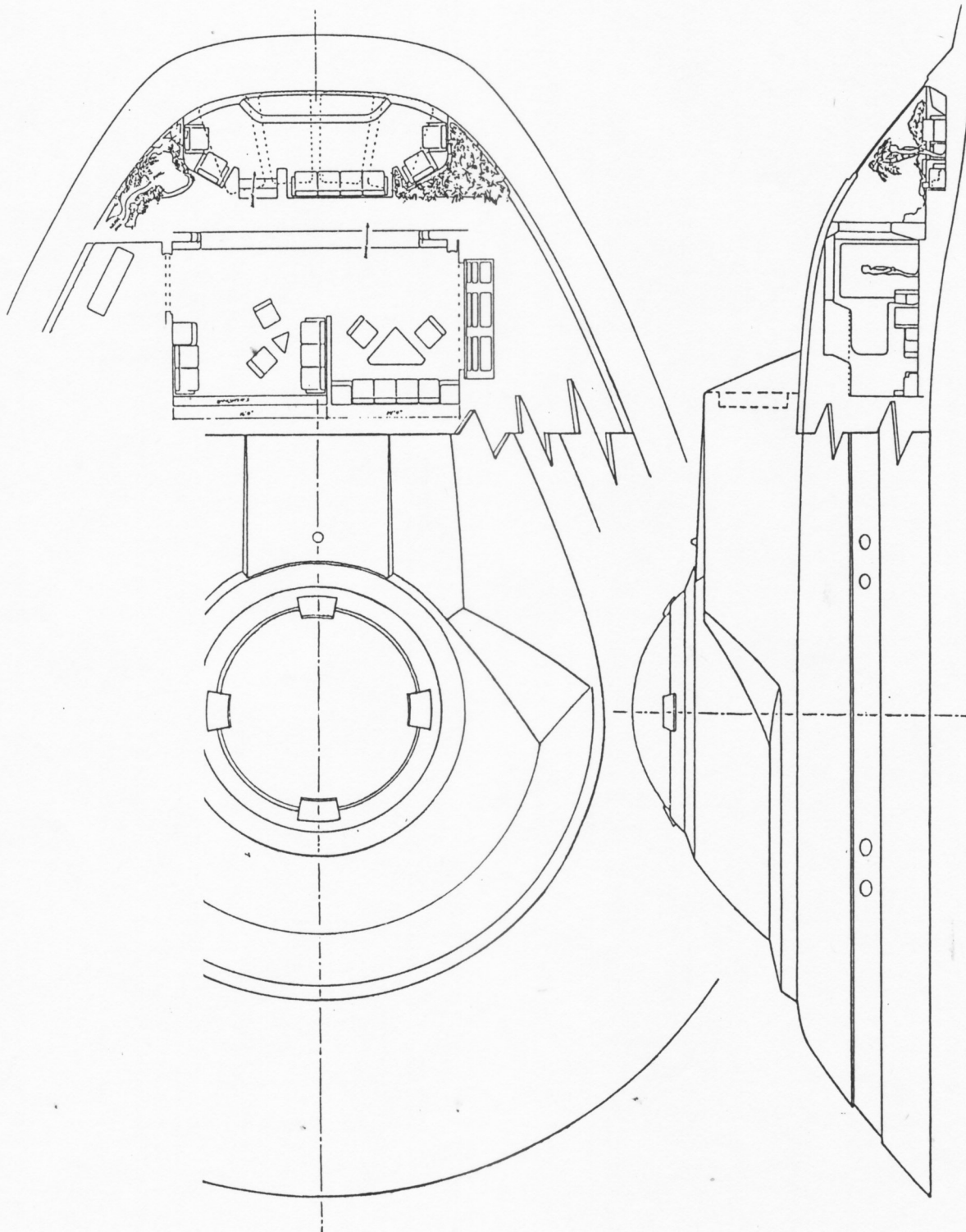

RS: 480371.6

TD: 01:04:01:09.48

AMENDMENT CODE:REV03

AUTHENTICATED STARDATE 8604.22



TRICORDER

DAYSTROM MICROMEMORY DUOTRONIC MODEL II

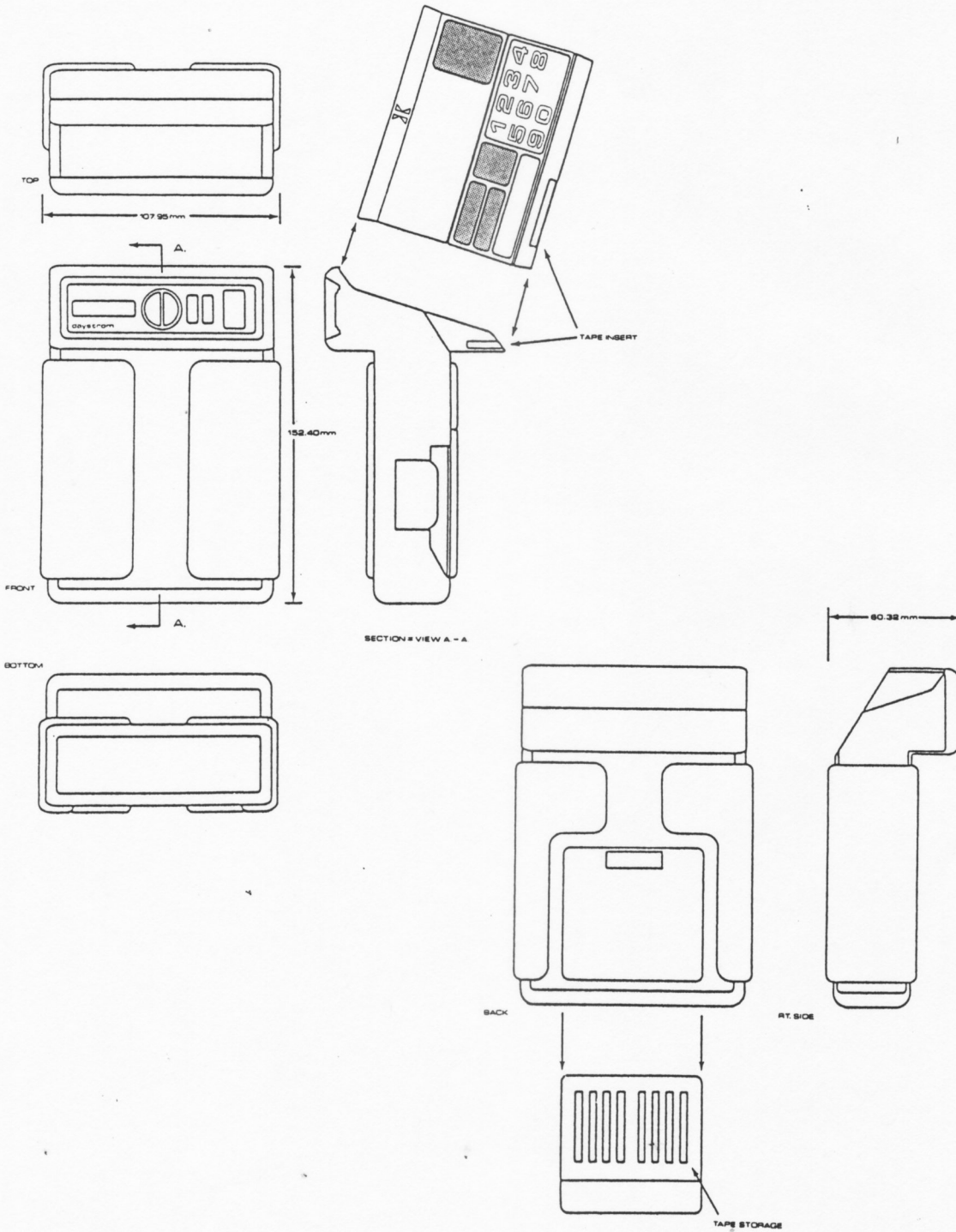

RS: 480371.4

TO: 02:04:00:38.01



PLANET "KAZH"

GENERAL DESCRIPTION

GENERAL DESCRIPTION OF PLANET "KAZH" (KLINGONKI KAZARA II)

KAZH IS THE SECOND PLANET ORBITING THE STAR KLINGONKI (SPECTRAL CLASS K1). BESIDES KAZH, THERE ARE SIX OTHER SIGNIFICANT OBJECTS ORBITING THE PRIMARY. THEY ARE:

NAME	DISTANCE FROM PRIMARY (AU)	MASS (EARTH = 1)	PLANET CLASS
HERAK	.46	1.13	C(2D)
KAZH	.80	2.33	M(3A)
ANG'AST	1.15	32.80	B(5Q)
FERSHAD	2.87	5,150.18	A(1U)
KAZARA	8.90	37,700.42	M5*
ATID	20.21	3,770.26	A(3B)
M'TRIN	44.68	59.50	B(3T)

*SPECTRAL CLASS

AS CAN BE SEEN FROM THE DESCRIPTION ABOVE, THE SYSTEM IS BINARY, WITH THE SMALL, REDDISH STAR KAZARA ORBITING THE LARGER KLINGONKI. THE PLANETS ANG'AST AND M'TRIN ARE SMALLER JOVIAN GAS GIANTS, WHILE FERSHAD AND ATID ARE EXTREMELY LARGE "FAILED" STARS. HERAK IS TERRESTRIAL, BUT HAS A VERY DENSE, REDUCING ATMOSPHERE AND A HIGH SURFACE TEMPERATURE (APPROXIMATELY 750°K). THIS LEAVES KAZH, A PLANET LARGER THAN EARTH WITH A SURFACE TEMPERATURE MODERATE ENOUGH TO ALLOW FOR THE FORMATION OF WIDE, SHALLOW (2-3 KM) DEPTH) OCEANS OF LIQUID H₂O.

BECAUSE OF ITS PROXIMITY TO MASSIVE ANG'AST, AND THE EXISTENCE OF KAZARA AND THE TWO LARGE GAS GIANTS, KAZH IS SWEEPED BY SIGNIFICANT TIDAL FORCES. THIS CONDITION IS EXACERBATED BY THE PLANET'S COMPLEMENT OF FOUR SMALL MOONS. THE GRAVITATIONAL "TUG-OF-WAR" THUS CREATED HAS RESULTED IN GREAT TECTONIC ACTIVITY. THE PLANET'S SURFACE IS CONSTANTLY BEING PULLED AT AND THUS IS BLEMISHED WITH MANY EXTENSIVE MOUNTAIN RANGES AND FAULT LINES. SUCH SURFACE DISTORTION HAS CREATED 3 MAJOR CONTINENTAL LAND MASSES AND 2 CONTINENTAL ISLANDS. THESE ARE CONNECTED BY NUMEROUS ISLAND CHAINS (ANOTHER PRODUCT OF THE PLANET'S ACTIVE VOLCANISM).

FOUR MAJOR HOMINID RACES (STA MURA, MURA, ZHAN BUR AND BUR CHAK) ARE BELIEVED TO HAVE EVOLVED ON THIS DYNAMIC PLANET. ALL SEEM TO HAVE ARISEN ON THE LARGEST CONTINENT. THE PARTICULAR PHYSIOGNOMY OF THE BUR CHAK APPARENTLY RESULTED FROM THEIR DIVERGENCE FROM THE MAIN EVOLUTIONARY PATH WHEN THE CONTINENT THEY INHABITED BROKE OFF FROM THE MAIN LAND MASS ABOUT 7.9×10^{13} SECONDS AGO. THIS ISLAND CONTINENT DRIFTED TO A POINT ON THE PLANET WHICH RECEIVED A RELATIVELY HIGH DOSE OF ULTRAVIOLET RADIATION DURING TIMES WHEN KAZARA APPROACHES KAZH. AS A RESULT, THEY EVOLVED A GLAND-RIDGE ALONG THE TOP OF THEIR SKULLS WHICH PRODUCES A KIND OF "SUN-SCREEN" THAT IS MIXED WITH BODY PERSPIRATION. WHILE ALL KAZH HOMINIDS HAVE THESE PECULIAR GLANDS, THEY ARE NOT WELL DEVELOPED IN ANY BUT THE BUR CHAK RACE.

THE PREDOMINANTLY STA MURA KINGDOM OF KLINGONI RULES KAZH THROUGH A FORM OF DESPOTIC FEDERALISM, IN WHICH THE PLANET'S 9 KINGDOMS, 54 PRINCIPALITIES AND 3 RELIGIOUS STATES ARE REPRESENTED. THIS GOVERNMENT ALSO FORMS THE POLITICAL CENTER OF THE INTERSTELLAR KLINGON EMPIRE.

BELOW FIND THE ENTRY IN ENCYCLOPAEDIA GALACTICA FOR THE DOMINANT KAZHIAN LIFE FORM:

XENOHOMINIS KAZH

BIOLOGY:

C, N, O, S, H₂O, PO₄.

DEOXYRIBONUCLEIC ACID.

GENETIC PROSTHESIS (ARTIFICIAL).

MOBILE HETEROTROPHS, SYMBIANTS WITH PHOTOSYNTHETIC AUTOTROPHS.

SURFACE DWELLERS, MONOSPECIFIC, POLYCHROMATIC O₂ BREATHERS.

Fe-CHELATED TETRAPYROLES IN CIRCULATORY FLUID. SEXUAL MAMMALS.

MASS RANGES 7×10^4 - 1.4×10^6 , LIFESPAN AVERAGE 2.4×10^9 SEC.

4×10^9 GENOMES.

CIVILIZATION LEVEL 1.2 L.

SOCIETY CODE 6.8 V, "KLINGON" (WE WHO CONQUERED).

EXTRAPLANETARY COLONIES: OVER 2,000.

TECHNOLOGY: EXPONENTIATING/HYPERPHOTICS/ANTIMATTER FUELS/GRAVITIC MANIPULATION/TRANSDIMENSIONAL ACCESS.

RS: 480371.2

TO: 02:07:01:04.01



PLANET "KAZH"

VISUAL



RS: 480371.2

TO:02:07:01:04.02

AMENDMENT CODE:C

AUTHENTICATED STARDATE 8500.10



PLANET "KAZH"

PLANETARY QUANTITIES

PLANETARY QUANTITIES OF "KAZH" (KLINGONKI KAZARA II)

SEMIMAJOR AXIS = 1.1968×10^{13} CM

ECCENTRICITY = 0.040023

INCLINATION = $23^{\circ} 41' 17''$

BOLOMETRIC ALBEDO = .34

REFERENCE TEMPERATURE = 251.0° K

MEAN SURFACE TEMPERATURE = 296.0° K

POLES OF ROTATION:

RIGHT ASCENSION = 18 HR 17 MIN 50.6 SEC

DECLINATION = $-34^{\circ} 23' 44''$

MASS = 1.392×10^{28} GRAMS

DYNAMICAL OBLATENESS = 3.3528×10^{-3}

RADIUS:

EQUATORIAL = 7.489275×10^8 CM

POLAR = 7.467890×10^8 CM

DENSITY = 7.934 G/CM³

SURFACE GRAVITY AT EQUATOR = $1.656.078$ CM/SEC²

AXIAL TILT = $24^{\circ} 15' 46''$

MAGNETIC FIELD < 3.6×10^{-2} GAUSS

PRECESSION PERIOD = 3.6604×10^{11} SEC

PERIAPSIS = 1.1489×10^{13} CM

APDAPSIS = 1.2447×10^{13} CM

PERIOD OF REVOLUTION = 2.5229×10^7 SEC

ROTATION PERIOD = 8.064×10^4 SEC

ESCAPE VELOCITY (SURFACE LEVEL AT EQUATOR) = 1.575×10^4 CM/SEC

PLANET AGE = 1.65×10^{17} SEC

ATMOSPHERE:

PRESSURE AT SURFACE = 1.23 BAR

DENSITY AT SURFACE = 1.346×10^{-3} G/CM³ AT 273.15° K

CONSTITUENTS AT SURFACE:

N ₂ 81.621%	Ne 18.9 PPM	SO ₂ 3.96 PPM
O ₂ 16.391%	He 8.67 PPM	H ₂ .11 PPM
Ar .340%	CH ₄ 3.2 PPM	N ₂ O .76 PPM
CO ₂ .771%	Kr 9.26 PPM	O ₃ .6 PPM
H ₂ O (MEAN) .9%	CO 1.02 PPM	Xe .11 PPM

RS: 480371.2

TO:02:07:01:04.04



PLANET "KAZH"

TACTICAL

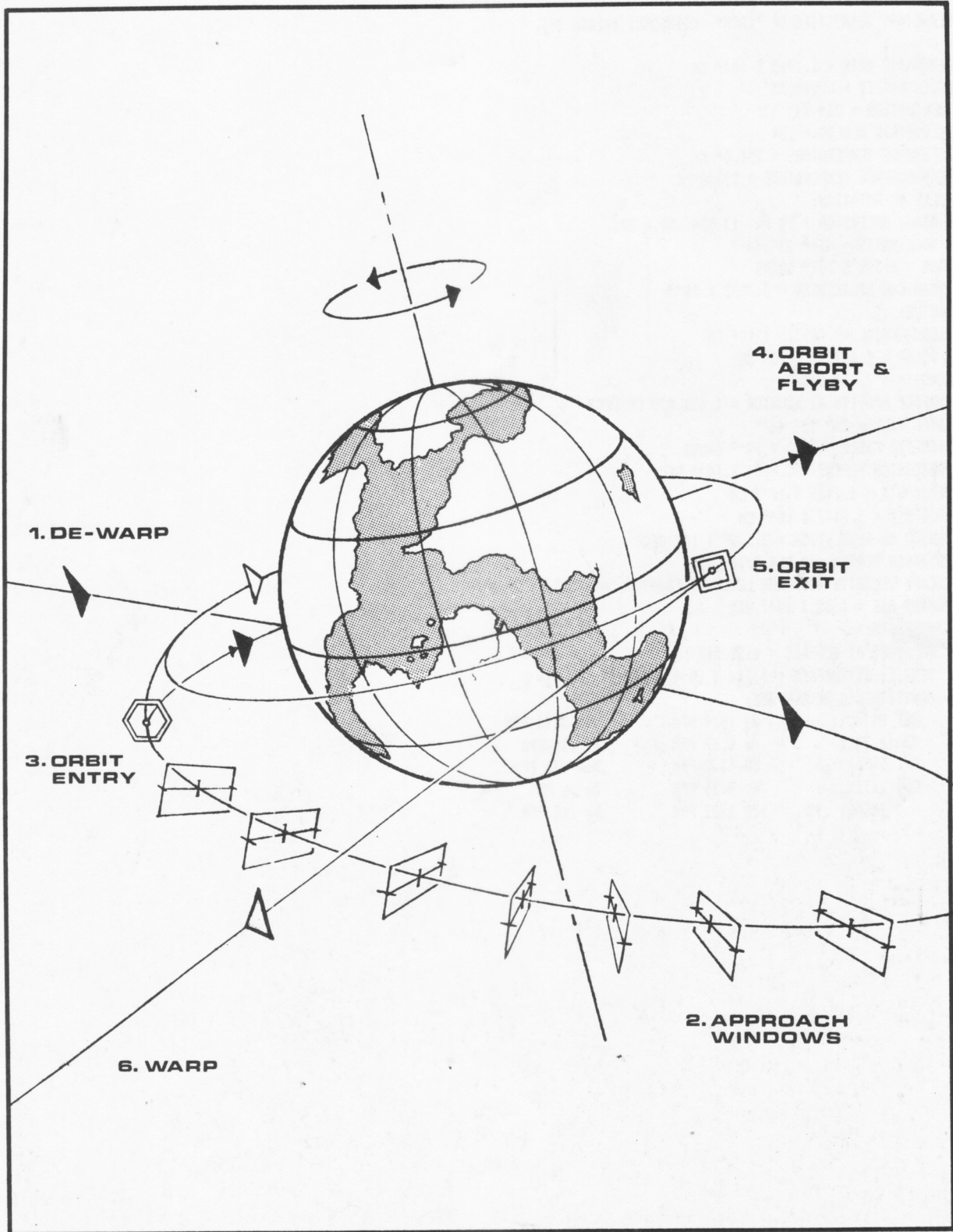

RS: 480371.2

TO:02:07:01:04.03



PRESSURE SUIT

HEAVY CONSTRUCTION DUTY-ARTIST'S CONCEPTION

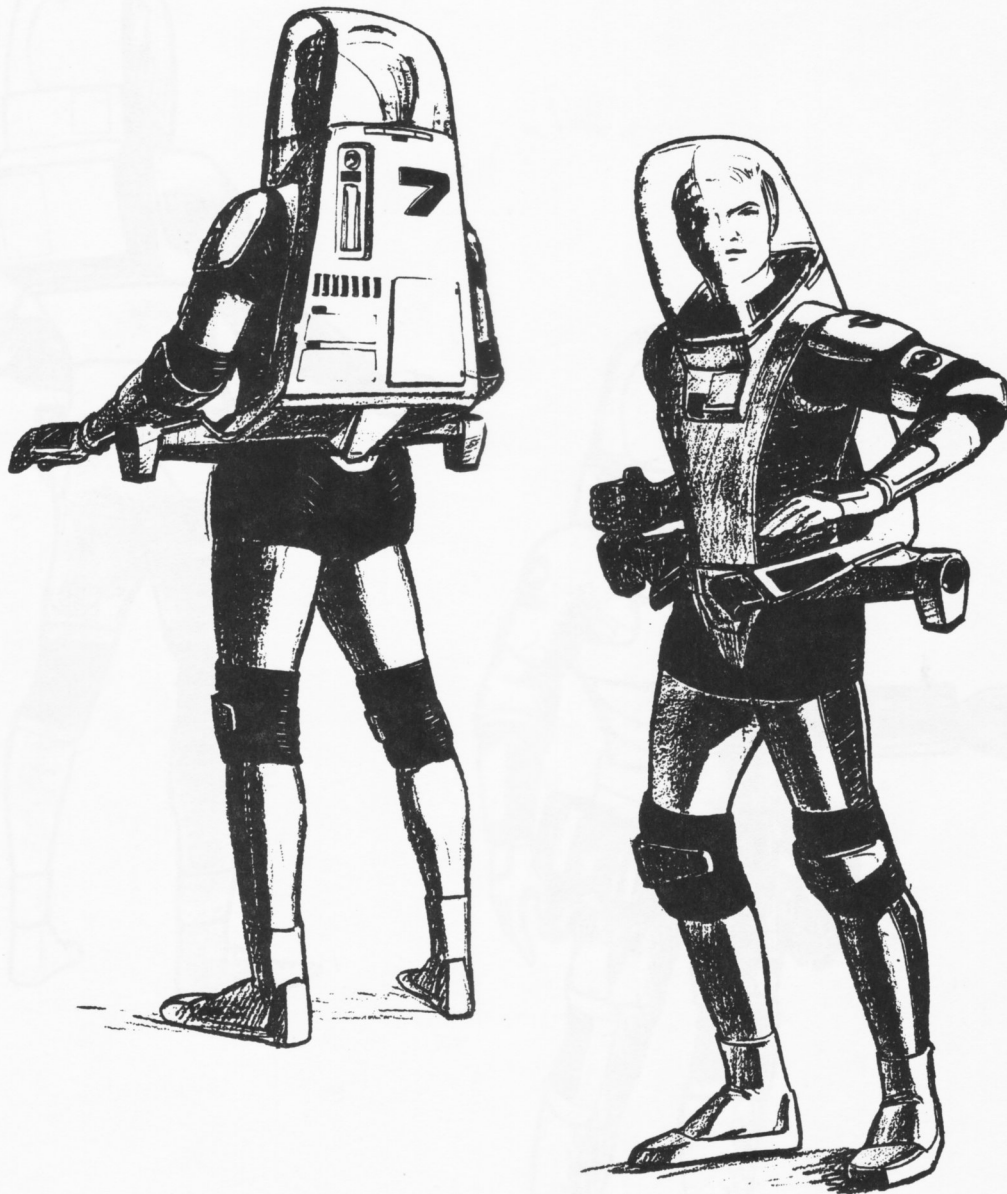

RS: 480371.6

TO: 03:06:70:08.01

AUTHENTICATED STARDATE 7912.02

AMENDMENT CODE:OR



PRESSURE SUIT

LIGHT CONSTRUCTION DUTY - ARTIST'S CONCEPTION

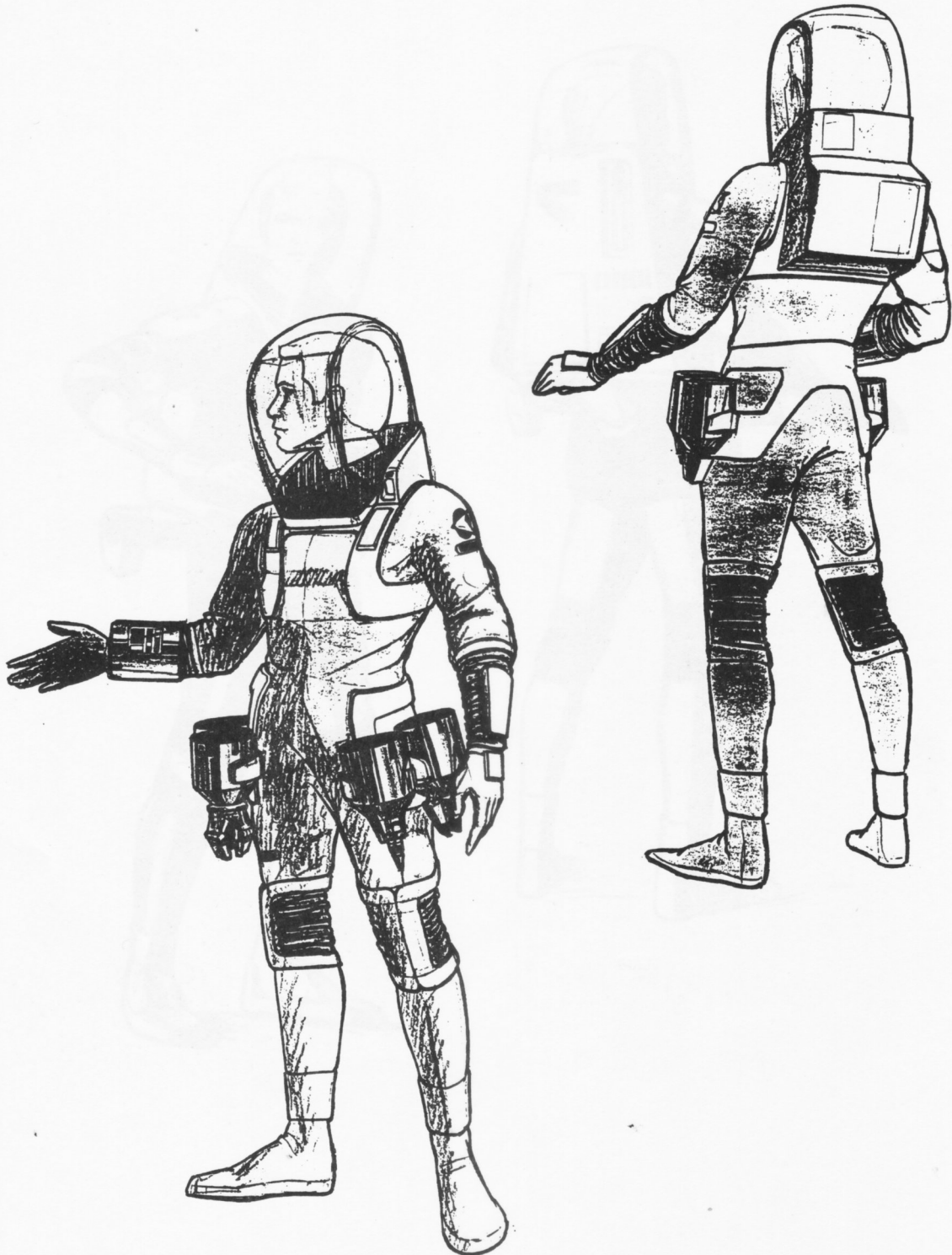

RS: 480371.6

TO:03:06:70:09.01

AMENDMENT CODE: OR

AUTHENTICATED STARDATE 7912.02



THRUSTER SUIT

ENVIRONMENTAL / EVACUATION UNIT - ARTIST'S CONCEPTION

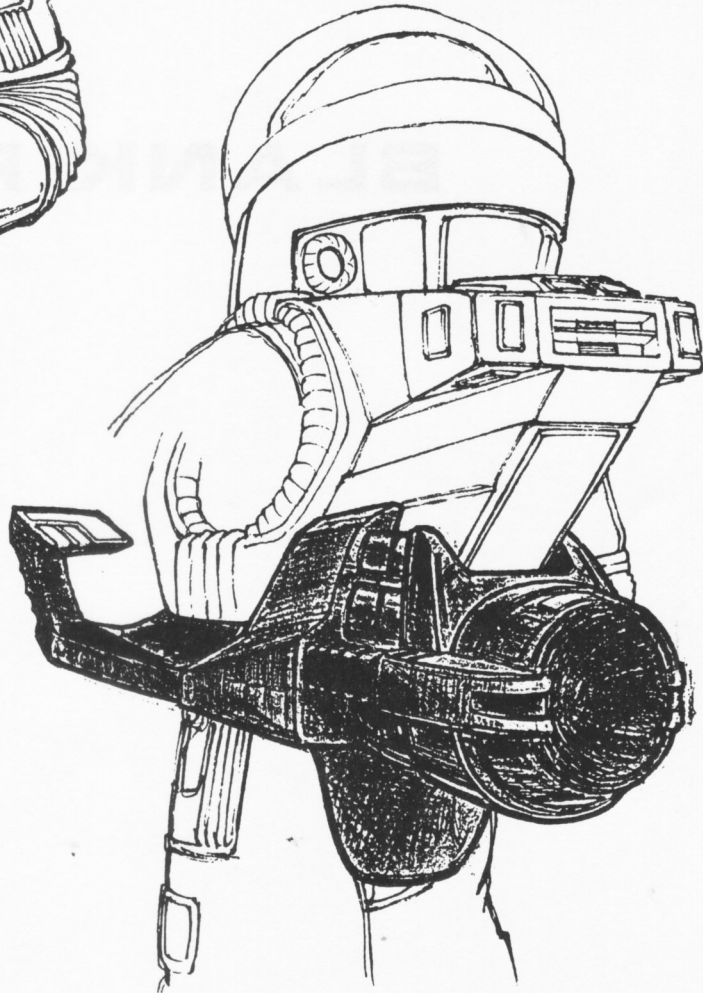

RS: 480371.3

TO: 03:06:70:12.01



STARSHIP DRYDOCKS

TYPES D-11 & D-14 ARTIST'S CONCEPTION

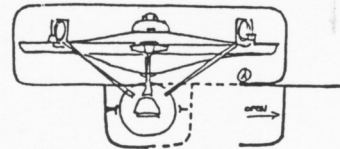
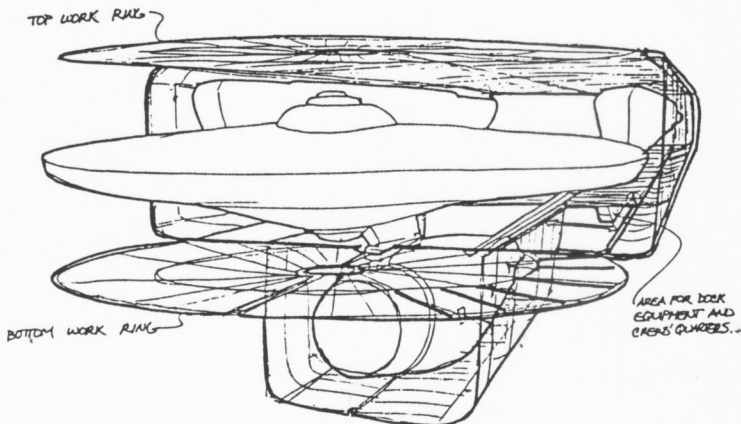
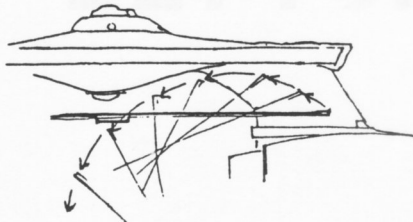
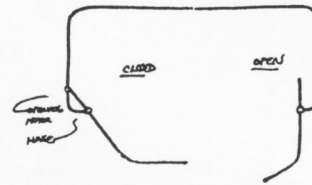
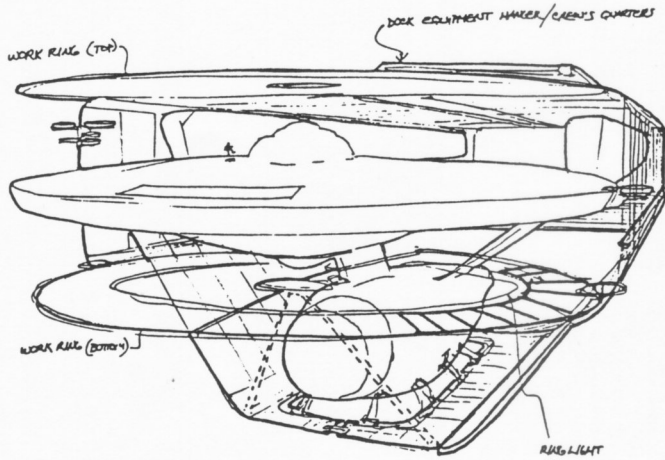

RS: 480371.3

TO: 03:08:41:10.02



DETAIL-OFFICE COMPLEX

STARSHIP DRYDOCK TYPE D-46 ARTIST'S CONCEPTION

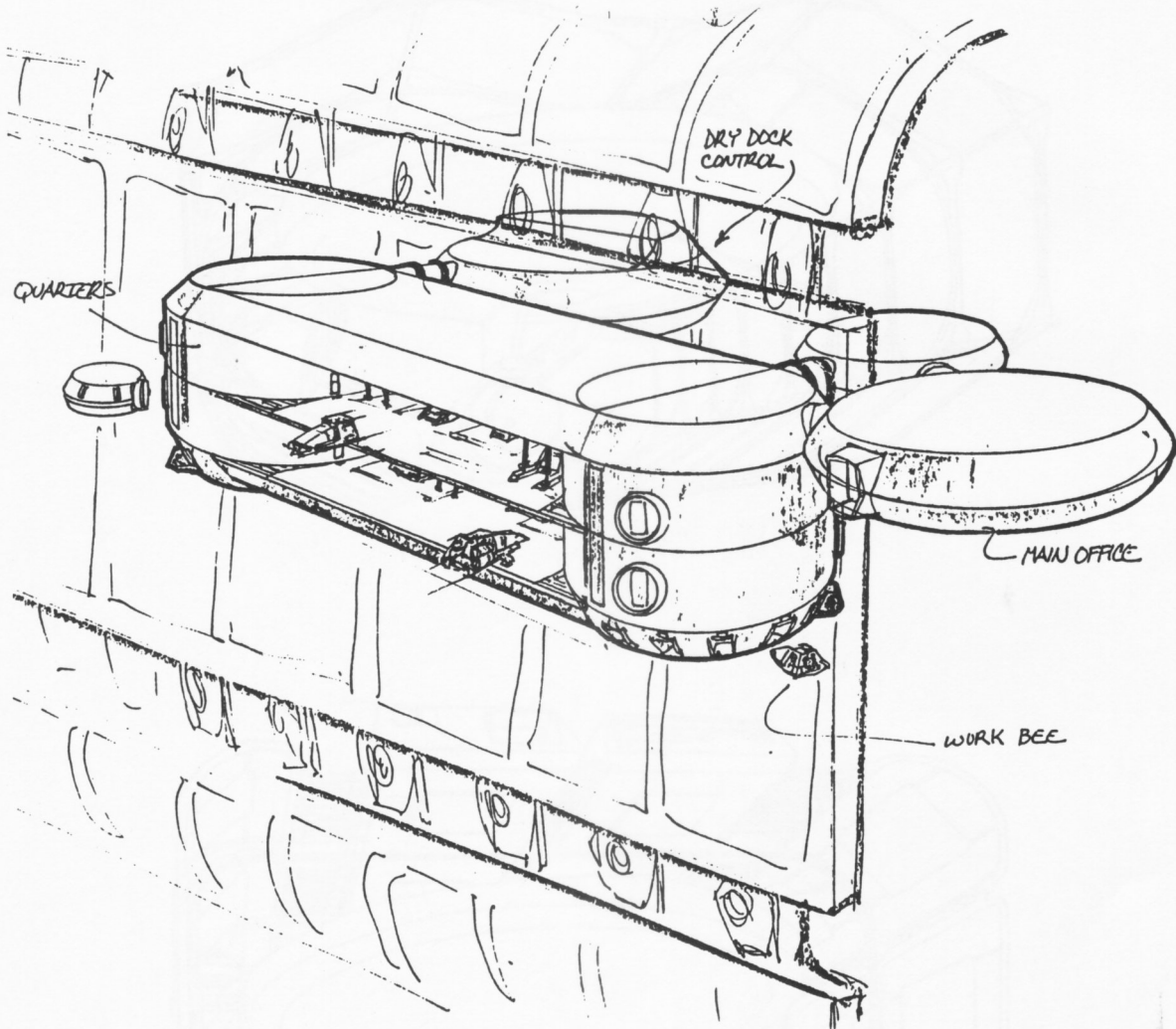

RS: 480371.3

TO: 03:08:41:40.01



STARSHIP DRYDOCKS

TYPES D-40 & D-46 ARTIST'S CONCEPTION

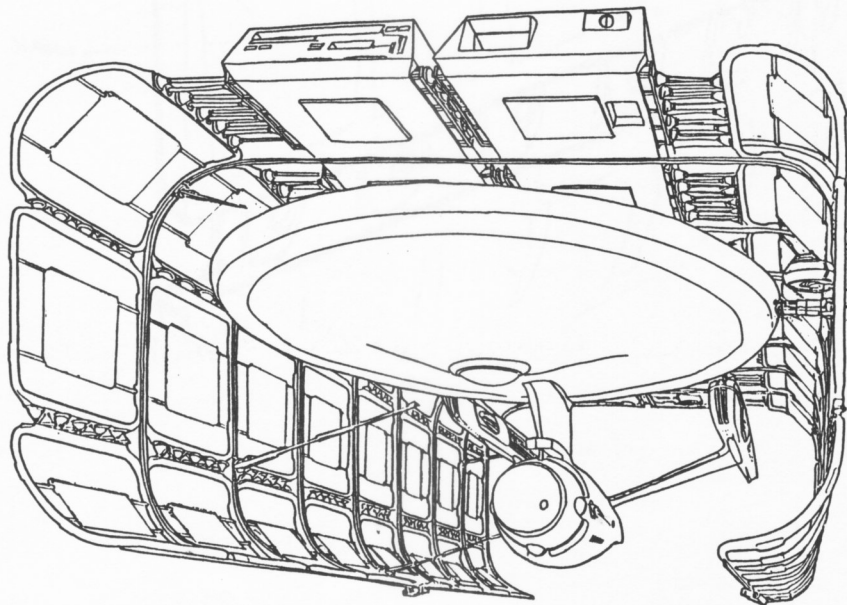
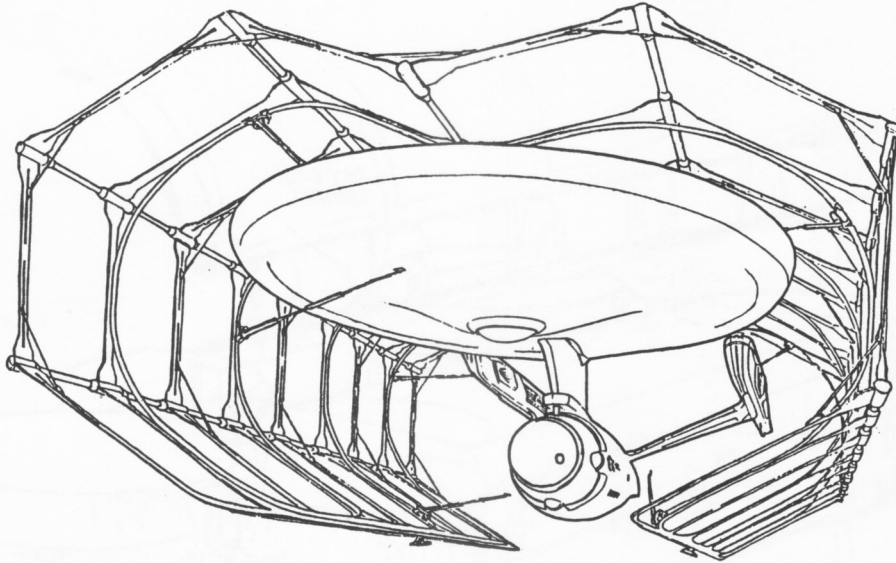

RS: 480371-3

TO: 03:08:41:40-02

AMENDMENT CODE:OR

AUTHENTICATED STARDATE 7911.30