

Revised

\$15.95



Jackill's STAR FLEET REFERENCE MANUAL

Ships of the Fleet Volume II



2

Written and Illustrated by
Eric Kristiansen

This book is a fictional work

Star Trek, *Star Trek: The Next Generation*, *Star Trek: Deep Space Nine*, are trademarks of Paramount Pictures. This book is not sponsored, approved or authorized by Paramount Pictures. This is a scholarly work intended to explain Trek technology in real statistics to show what is needed to reach these levels of technology. All ideas in this book are expressed as a continuation of thoughts covering the American pop culture associated with Treknology. Some of the vessels included in this manual are the creation of others that have appeared in Federation publications. Their inclusion in this book is not intended as an infringement of their copyright in any way, but rather is done in the interest of maintaining continuity. No photos or artwork appearing in this book are copyright of Paramount Pictures. All artwork contained in this book is original.

First printing January 1993

1098765432

Printed in United States of America





Dedication

INTRODUCTION

GENERAL INFORMATION

To my parents
who have always been there for me

Intro Info

Welcome reader to the first edition of Jackill's Star Fleet Reference Manuals. The descriptions of these futuristic vessels are a critique of their abilities and are related in contemporary terms as accurately as possible. The technology described here can be compared to existing technologies in other books, on television and in the movies. Hopefully, the information herein will provide a base of knowledge allowing one to understand the advancements required to achieve this level of technology. The book is presented in a futuristic format for reading enjoyment and should not be confused with any material from that time period.

The information contained in this manual is as accurate as allowed due to Star Fleet's ongoing program of misinformation intended to confound and confuse the intelligence efforts of potentially threatening forces. For high-level accuracy, consult Star Fleet archives.

Although not all statistics are given, all descriptions, drawings and statistics are intended to familiarize the reader with these vessels. Numerical statistics, such as weight and length, are given with the highest degree of accuracy available at the time of publication.

Read on fellow traveler, I hope that the information provided will increase your understanding of Life, the Universe and Everything.

Jackill

Contents

Intro Page Numbers	SRM2 01:01:01:01
Statistics	SRM2 01:02:01:01
Shuttle Intro / Size	SRM2 02:01:01:01
Assault Shuttle	SRM2 02:02:01:01
Fighter	SRM2 02:02:02:01
Heavy Shuttle	SRM2 02:02:03:01
Shuttlepod	SRM2 02:02:04:01
Survey Shuttle	SRM2 02:02:05:01
Workbee (General Utility Craft)	SRM2 02:02:06:01
Space Station Intro	SRM2 03:01:01:01
Station Size Comparison	SRM2 03:01:01:02
Communication Station	SRM2 03:02:01:01
Spacedock	SRM2 03:02:02:01
Spacelab	SRM2 03:02:03:01
Trading Post	SRM2 03:02:04:01
Starship Introduction	SRM2 04:01:01:01
Ship Size Comparison	SRM2 04:01:01:02
Attack Cruiser	SRM2 04:02:01:01
Battle Cruiser	SRM2 04:02:02:01
Battleship	SRM2 04:02:03:01
Escort Cruiser	SRM2 04:02:04:01
Gunboat	SRM2 04:02:05:01
Light Corvette	SRM2 04:02:06:01
Penetration Cruiser	SRM2 04:02:07:01
Strike Cruiser	SRM2 04:02:08:01
Troop Transport	SRM2 04:02:09:01
Heavy Shuttlecraft Carrier	SRM2 04:03:01:01
Through Deck Carrier	SRM2 04:03:02:01
Through Deck Cruiser	SRM2 04:03:03:01
Heavy Scout	SRM2 04:04:01:01
Scout	SRM2 04:04:02:01
Exploratory Cruiser	SRM2 04:05:01:01
Research Vessel	SRM2 04:05:02:01
Star Cruiser	SRM2 04:05:03:01
Survey Cruiser	SRM2 04:05:04:01
Timeslip Cruiser	SRM2 04:05:05:01
Hospital Ship	SRM2 04:06:01:01
Medical Frigate	SRM2 04:06:02:01
Containers	SRM2 04:07:01:01
Closing	SRM2 05:01:01:01

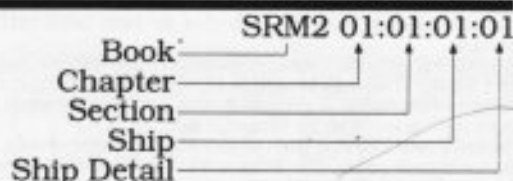

INTRODUCTION

INTRODUCTION



This is an overview of what some of the statistical information you will run across in this reference manual mean.

Statistics

Acceleration Power: Is the value that a warp number is raised to to determine its speed as a multiple of light.

Acceleration Rate: Lists the various times it takes to accelerate the vessel through sublight speeds.

Acceleration Times: Lists the time it takes to accelerate from one warp value to the next. It should be noted that although an acceleration time may be given, the craft may not be designed to reach that speed without disintegration.

Beds: Lists the number of beds in the medical facility.

Bottom Profile: This profile is used for familiarization of the bottom view of the vessel.

Breakdown Rate: Is the amount of power in watts that will eventually break down the shields if applied constantly.

Brigs: Lists the number of detention cells.

Cargo Specification: Lists the number of standard cargo units and the cargo capacity of all the containers.

Category: Lists the general classification of the ship such as frigate, destroyer, freighter, etc.

Class Emblem: Each ship class is given a distinct logo design to represent the entire class.

Classification: Lists the exact designation of the craft, such as assault frigate or attack frigate.

Class: Is the name assigned to distinct vessel designs to distinguish one design from another. An example being one heavy cruiser from another heavy cruiser design.

Cloaking Devices: Lists if the vessel is equipped with a cloaking shield.

Computers: Lists the number and type of computers onboard.

Cross Section: This cut away view is used for general familiarization of the interior arrangement of the vessel.

Cross Section Area: Lists the optimum cross section area that the warp field has for each profile.

Destructive Speed: Is the speed at which the vessel will start to tear apart due to excessive stress.

Dimensions: Listed in meters for various parts of the ship from the primary hull to the propulsion systems.

Doctors: Lists the number of medical doctors that are normally onboard.

Duration: Is given for both standard (years between upgrades) and maximum (maximum years until the craft must be rebuilt) missions.

ECM Index: Is given as general guide to the craft's ability to evade detection. The index norm is based on the Heavy Cruiser.

Emergency Condition: Is the additional number of people that the craft can carry in an emergency.

Emergency Speed: Lists the fastest that the craft can travel for very short periods of time. The longer the craft travels at this speed the more the engines and hull are damaged.

Field Height: Is the optimum warp field height listed in meters.

Field Length: Is the optimum warp field length listed in meters.

Field Width: Is the optimum warp field width listed in meters.

Front Profile: This profile is used for familiarization of the front view of the vessel.

General Information: Is used to deliver additional information about the vessel.

Holdoff Power: Is given in watts and determines the power level that will breach the shields.

Hx: (Hertz) Cycle per second.

Impulse Engine Output: Lists the engine output in watts.

Impulse Power Index: Is given as general guide to the vessel's overall impulse power. The index norm is based on the Heavy Cruiser.

Impulse Unit: Lists the impulse engine model number.

Laboratories: Lists the number of individual laboratories.

Max. Cruising: Lists the maximum speed that the impulse drive can propel the vessel.

Maximum Speed: Lists the fastest that the vessel can travel for sixty seconds before complete engine destruction.

Max. Safe Cruising: Lists the warp that the vessel can travel without substantial decrease in handling and safety. This speed is the fastest that the craft can travel without damaging the engines.

Medical Facilities: List the statistics of the medical facility.

Model: Is a Roman numeral that is distinct to each vessel category for each type/class.

Naval Construction Contract: Lists the number series assigned to that particular vessel series for construction and vessel registration.

Number Constructed: Lists how many vessels have been built.

Number in Service: Lists how many vessels are on active duty.

Number Lost: Lists how many vessels have been destroyed or decommissioned for various reasons.

Number Proposed: Lists the number of vessels that are to be built.

Nurses: Lists the number of nurses that are normally aboard.

Operating Rooms: Lists the number of fully equipped operating rooms.

Optimum Speed: Lists the warp that the vessel travel with the best fuel-distance ratio with minimal wear to the engines.

Output: Listed in watts for each shot for both burst and continuous fire, if available.

Passengers: Lists the number of passengers that the craft may carry.

Port Profile: This profile is used for familiarization of the port view of the vessel.

Phaser Power Index: Is given as general guide to the vessel's phaser power. The index norm is based on the Heavy Cruiser.

Photon Power Index: Is given as general guide to the vessel's photon torpedo power. The index norm is based on the Heavy Cruiser.

Primary Reactor Output: List the output of the primary power source in watts.

Range: Is the weapons' effective range.

Rate of Fire: Lists the number of shots per minute that the weapon is able to fire.

Rear Profile: This profile is used for familiarization of the rear view of the vessel.

Refresh Rate: Is given in watts and shows how fast the shields will replenish themselves.

Replicators: Lists the vessel's ability to create materials and equipment.

Secondary Reactor Output: List the output of the secondary power source in watts.

Sensor Index Values: Is a general guide to the vessel's sensor abilities. The index norm is based on the Heavy Cruiser.

Shield Dimensions: Listed in meters for the normal operating dimensions of the shields.

Shield Index: Is given as general guide to the vessel's overall shield power. The index norm is based on the Heavy Cruiser.

Shield Rating: Lists the specification of the shields.

Ship Names: Is an alphabetical listing along with their naval construction contract numbers for the vessels that have been authorized for construction.

Shuttlecraft Bays: Listed below are the general dimensions for each category of shuttlecraft bay.

Small Bay: Landing area dimensions of 20-800 sq.m with a normal deck height of 2.4-6 meters. Vehicle storage area dimensions of 20-800 sq.m with a normal deck height of 2.4 meters.

Medium Bay: Landing area dimensions of 800-2000 sq.m with a normal deck height of 6-10 meters. Vehicle storage area dimensions of 800-2000 sq.m with a normal deck height of 2.4 meters.

Large Bay: Landing area dimensions of 2000-10000 sq.m with a normal deck height of 6-10 meters. Vehicle storage area dimensions of 2000-10000 sq.m with a normal deck height of 2.4-3.2 meters.

Super Bay: Landing area dimensions of 10000+ sq.m with a normal deck height of 8-12 meters. Vehicle storage area dimensions of 10000+ sq.m with a normal deck height of 2.4-4.8 meters.

Shuttlecraft Specifications: Lists the number of docking ports, shuttlecraft bays, number and type of shuttlecrafts and lifeboats.

Silhouettes: Is given for both recognition and to show the vessels' target area from various profiles. The smaller the area, the harder the ship is to target from that profile. The area values do not take into consideration the vessel's electronic counter measures.

Size Comparison: Gives port views for a comparison of the vessels' size in relation to other vessels.

Speed vs. Time: Is a graph that shows warp speed vs. time.

Std. Ships Complement: Is the standard number of crew members for the vessel. The listing is broken up into Officers, Crew and Troops.

Stock: Is given if the weapon has a finite supply of shots.

Telemetry: Lists the number of communication channels available for transmission of data and the power output of those transmissions listed in watts.

Top Profile: This profile is used for familiarization of the top view of the vessel.

Total Target Area: Is created by adding the top, port and front areas to give a generalization of the vessels overall target size.

Tractor Beam Specifications: Uses a tractor beam load calculator to calculate range vs. tonnage at each warp speed [See Tractor Beam on page SRM1 05:01:01:01 for information on how to use].

Tractor Beams: Is given for both the max. range and tow capacity.

Transporters: Lists the total number and type of units.

Type: Is a general term used to categorize the crafts abilities.

Class 1: Is used for starships that are designed with flexibility in their operating parameters.

Class 2: Is used for support ships that are designed for a specific mission and don't have much flexibility in their design.

Class 3: Is used for space station and habitable space facilities. The general rule is that the complex has recreational facilities and permanent residences.

Class 4: Is used for space facilities such as dry docks and refineries, generally not used as habitable environments.

Class 5: Is used for shuttlecraft and small support vessels.

Class 6: Is used for automated craft and facilities with little or no habitable environment provided for in the design.

Class 7: Is used to designate non-powered, space-going vessels such as cargo containers.

Class 8: Is used to designate items such as torpedoes, probes and buoys.

Vessel Power Index: Is given as general guide to the craft's overall weapon power. The index norm is based on the Heavy Cruiser.

Warp Engine Output: Lists the intermix chamber output in watts.

Warp Fields: Shows the field curvature around the vessel at optimum field configuration. The more slender the lateral field the less energy needed to propel the craft through space.

Warp Power Index: Is given as general guide to the craft's overall warp power. The index norm is based on the Heavy Cruiser.

Warp Speed/Power Graph: Is a two-sided graph used to show the power consumption based on the speed of the vessel.

Warp Units: Lists the warp drive model number.

Weapon (Type) Total: Gives the number of banks/bays and how many phasers/tubes per bank/bay. (A weapon location is given for the position of each weapon facing and can be used as a general guide of the weapon's angle of attack).



LIGHT CRAFT

General Information

A large number of small support vehicles are required by Starfleet in order to carry out various missions such as construction, transportation and defense. Shuttlecraft are predominantly designed for specific mission requirements in order to create the smallest, most effective package.

Shuttles are sometimes very useful for moving small groups of people when transporters can not be used for one reason or another.

GENERAL INFORMATION

Size Comparison



WorkBee



Assault Shuttle

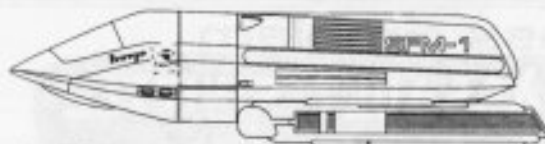

DualBee



Fighter

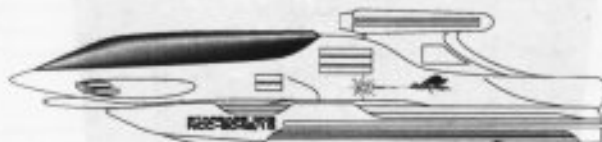

Assault Bee

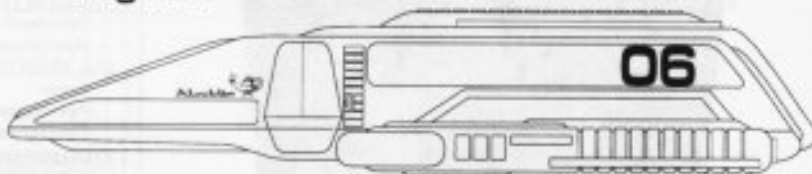

Heavy Shuttlecraft

Super Bee

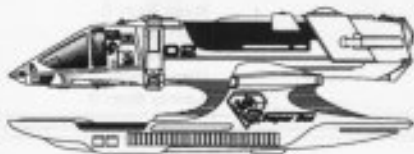

Shuttlepod



Killer Bee



Survey Shuttle

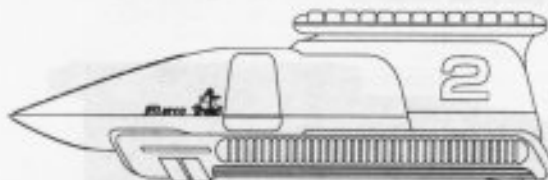

WorkBee Train

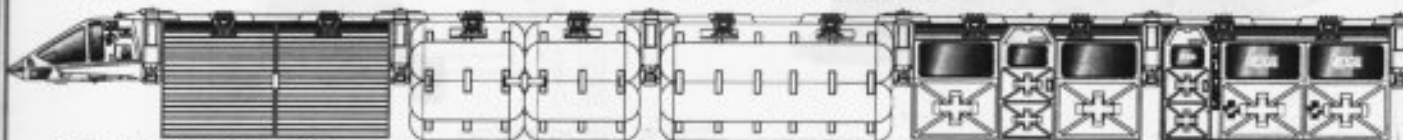

FEDERATION CRAFT

ASSAULT SHUTTLE



IMP CLASS

General Information

Specific Role: The Assault Shuttlecraft is the main small craft deployed by the United Federation of Planets Peace Keeping Forces (Starfleet Marines) for an assault role. The Shuttle's role is two fold: point assault and the delivery of assault troops through the large door located to the rear of the vessel.

Physical Description: The hull is shaped in a long wedge and it is equipped with three doors. Two of the doors are located one on either side of the crafts forward section and the third serves as a sliding hatch that opens the rear section completely. Positioned on both sides of the shuttle are (SMDN5/3-8) navigational sensor arrays. This shuttle is equipped with both (BP1/12-5S) phasers and (PB1/12-8W) photon missiles. The phasers are mounted both port and starboard just forward of the main hatches and the photon missile launchers are installed below on the lower hull. Sublight propulsion is provided by the impulse drive system located on the lower rear section of the craft. Warp power is provided by (SW7/1-4ED) micro-nacelles which are mounted on each side of the hull.

Class Emblem

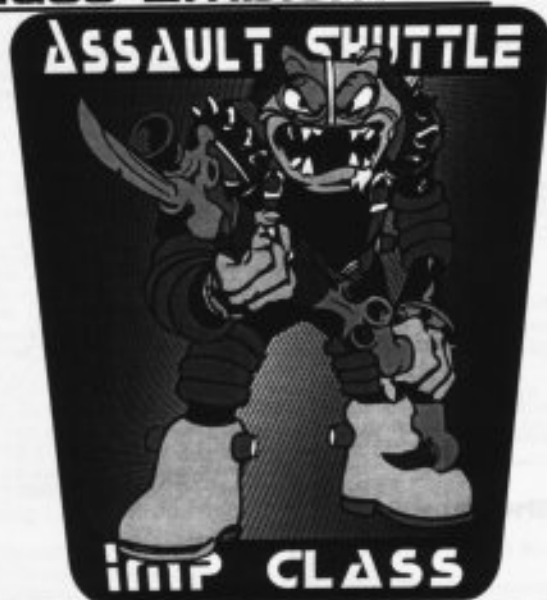

Statistics

Classification: Assault Shuttle
Category: Shuttlecraft
Class: Imp
Type: Class 5
Model: MK-VI
Naval Construction Contract: AS-11
Dimensions:
Overall Dimensions (Meters)
 Length: 9.916m
 Width: 4.021m
 Height: 2.525m
Displacement (Metric Tons)
 Light: 5.06mt
 Standard: 5.63mt
 Full Load: 6.47mt
Performance:
Impulse Units: Dual Unit (ID35E4-UP)
Impulse Engine Output: 8.5×10^8 W
Max Cruising: C
Acceleration Rate:
 0.00-0.25 Impulse: 0.125 sec.
 0.25-0.50 Impulse: 0.187 sec.
 0.50-0.75 Impulse: 0.250 sec.
 0.75-Full Impulse: 0.312 sec.
Warp Units: 2 Nacelle Units (SX09/1-58X)
Warp Engine Output: 1.6×10^7 W
Optimum Speed: Warp 2
Max. Safe Cruising: Warp 3
Emergency Speed: Warp 4
Max. Speed: Warp 4.2
Destructive Speed: Warp 4.5
Acceleration Power: 3.0
Acceleration Times:
 Warp 1 - Warp 2: 2.205 sec.
 Warp 2 - Warp 3: 2.688 sec.
 Warp 3 - Warp 4: 5.116 sec.
 Warp 4 - Warp 5: N/A
 Warp 5 - Warp 6: N/A
 Warp 6 - Warp 7: N/A
 Warp 7 - Warp 8: N/A
 Warp 8 - Warp 9: N/A
 Warp 9 - Warp 9.5: N/A
 Warp 9.5 - Warp 9.75: N/A
 Warp 9.75 - Warp 9.9: N/A
Duration (Years)
 Standard: 5 Years
 Maximum: 20 Years
Std. Ships Complement: 1
 Crew: 1
 Passengers: 9
 Emergency condition: +6
Transporters Total: 1
 1 Person: 0
 2 Person: 1
 6 Person: 0
 Small Cargo: 0
 Medium Cargo: 0

Tractor Beams: 1
Tow Capacity: 4.90×10^2 mt
Max Range: 6.83×10^1 km
Cargo Specification:
Standard Cargo Units: N/A
Cargo Capacity: N/A
Shuttlecraft Specifications:
Docking Ports: 0
Cloaking Devices: 0
Sensor Index Values:
Planetary Survey: 1.354
Stellar Survey: 0.942
Short Range: 1.158
Long Range: 1.100
Navigation: 0.975
Special: 1.145
Computers: 2
Type: Norray-Magne 16:u
Type: Norray-Magne 14:g
Shield Rating:
Holdoff Power: 4.98×10^8 W
Refresh Rate: 1.48×10^8 W
Breakdown Rate: 1.75×10^8 W
Shield Dimensions (Meters)
 Length: 11.89m
 Width: 4.825m
 Height: 3.03m
Weapons:
Weapon Placement:
Beam (Phasers) Total: 2 Mounts
Output: 5.0×10^8 W / 2.5×10^8 W
Range: 2.5×10^3 km
Rate of Fire: 20 ppm / Cont.
Forward Banks: 1
Rear Banks: 0
Port Banks: 0
Starboard Banks: 0
Upper Banks: 0
Lower Banks: 0
Beam (Heavy Phasers) Total: 0
Output: N/A
Range: N/A
Rate of Fire: N/A
Forward/Rear Banks: 0
Port/Starboard Banks: 0
Upper/Lower Banks: 0
Missiles (Photon) Total: 2 Tubes
Stock: 30
Range: 2.0×10^5 km
Output: 5-11 Megatons
Rate of Fire: 10 spm
Forward Bay: 2
Rear Bay: 0
Port Bay: 0
Starboard Bay: 0
Upper Bay: 0
Lower Bay: 0

Craft Silhouettes

Total Target Area 56.90 m²



Top Silhouette
Area 31.52 m²



Port Silhouette
Area 18.96 m²



Front Silhouette
Area 8.32 m²

FEDERATION CRAFT



ASSAULT SHUTTLE

IMP CLASS

FEDERATION CRAFT

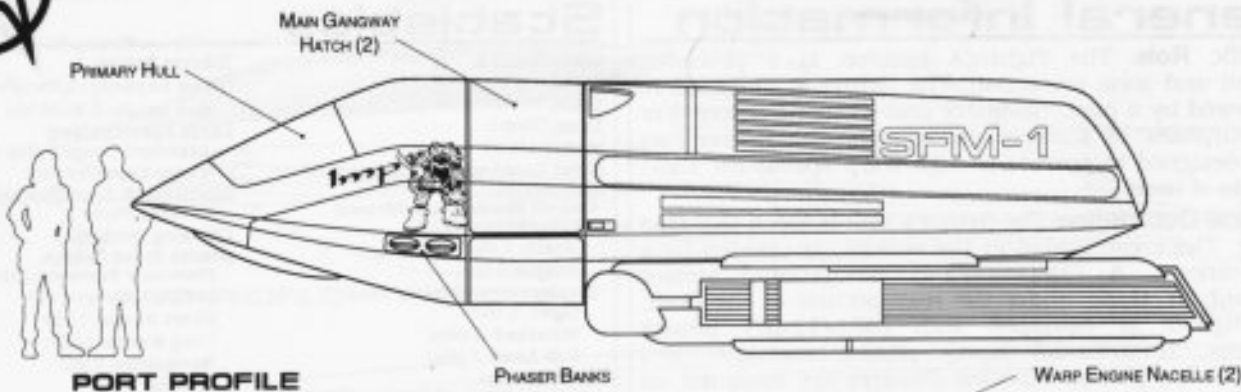

PORT PROFILE

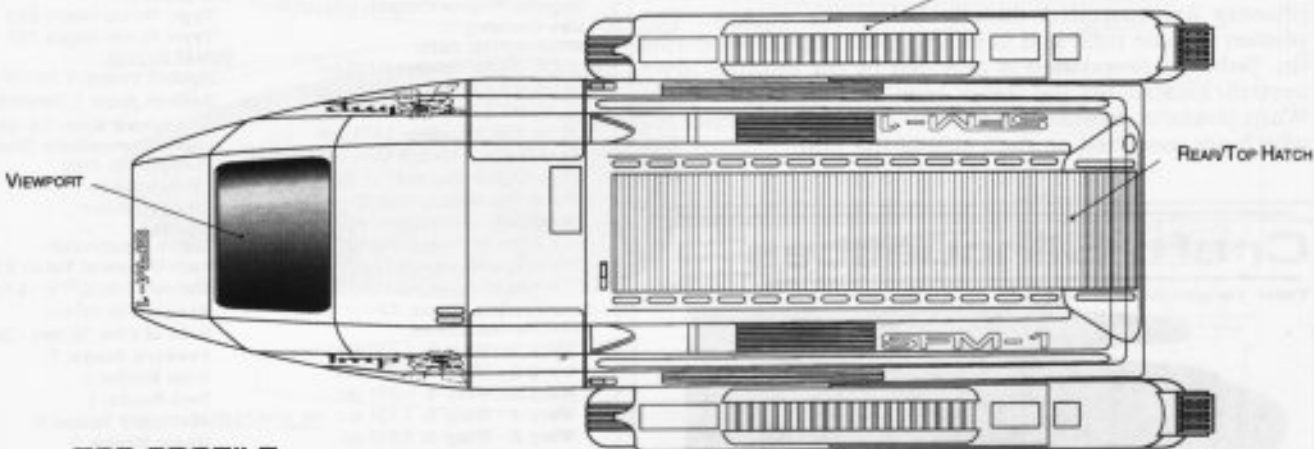

TOP PROFILE

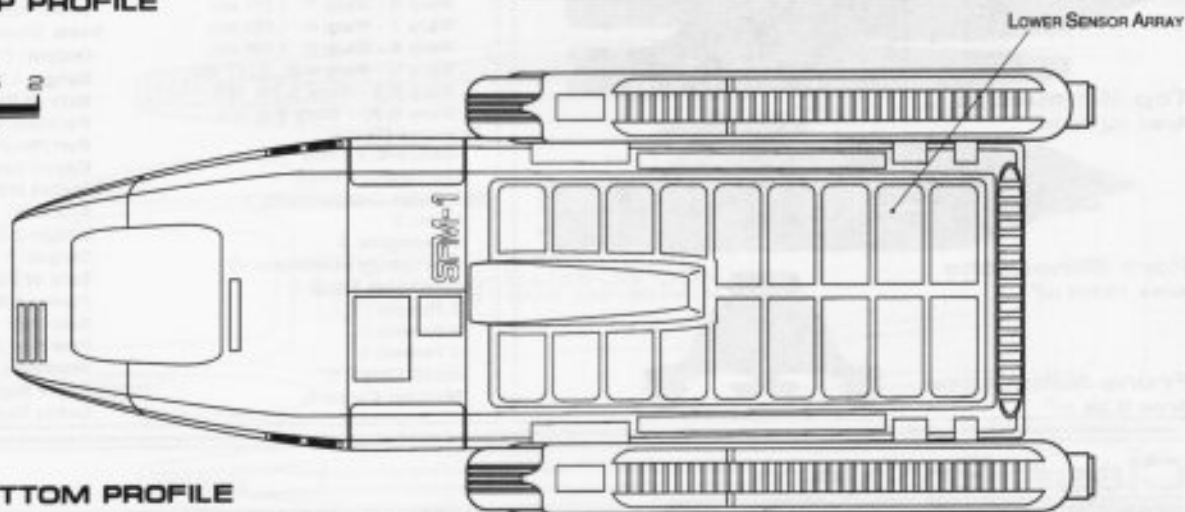
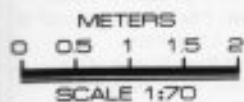

BOTTOM PROFILE

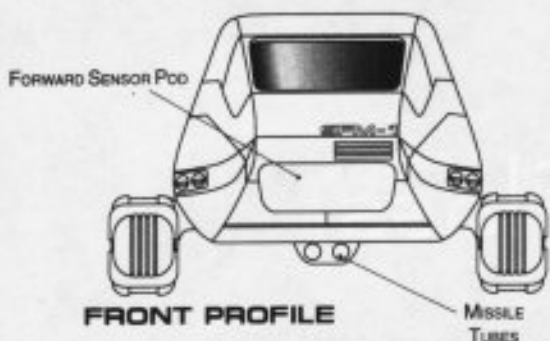

FRONT PROFILE

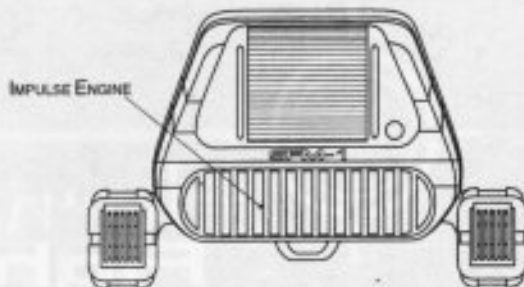

REAR PROFILE

FIGHTER



HORNET CLASS

General Information

Specific Role: The Fighter's mission is a precision assault and zone protection. The fighter is designed to be crewed by a pilot, navigator and weapons officer. For the purposes of starship engagement the fighter has been designed to operate at high warp speeds for short periods of time.

Physical Description: The fighter's hull is sleek teardrop shape. The crew, seated in the cockpit, is covered by a full canopy. A (SMDN22/3-7) navigational sensor assembly is slung under the rear portion of the craft. The fighter is equipped with (BP1/12-5F) phaser cannons, (BP2/24-2J) heavy phaser cannons, and (PB1/12-8A) photon missiles. Phasers are mounted on either side of the hull just below the canopy, and heavy phasers are mounted directly below the cockpit. The photon missile tube pod is mounted on top of the dorsal fin. Sublight propulsion is provided by the impulse drive system located on the lower rear section of the craft. Warp power is provided by (SW15/1-2GF) micro-nacelles which are mounted on each side of the hull.

Craft Silhouettes

Total Target Area 84.44 m²

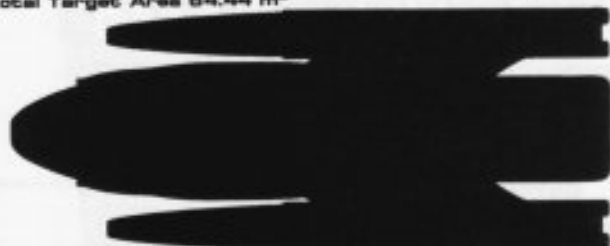

Top Silhouette
Area 40.08 m²



Port Silhouette
Area 19.04 m²



Front Silhouette
Area 5.32 m²

Statistics

Classification: Fighter
Category: Fighter
Class: Hornet
Type: Class 5
Model: MK-VII
Naval Construction Contract: SF-11
Dimensions:
Overall Dimensions (Meters)
 Length: 11.01m
 Width: 4.44m
 Height: 3.00m
Displacement (Metric Tons)
 Light: 6.16mt
 Standard: 6.84mt
 Full Load: 7.86mt
Performance:
Impulse Units: Dual Pack (IP35E/4-10)
Impulse Engine Output: 9.9x10⁸ W
Max Cruising: C
Acceleration Rate:
 0.00-0.25 Impulse: 0.109 sec.
 0.25-0.50 Impulse: 0.165 sec.
 0.50-0.75 Impulse: 0.220 sec.
 0.75-Full Impulse: 0.274 sec.
Warp Units: 2 Nacelle Units (SB4/1-3TH)
Warp Engine Output: 3.1x10¹² W
Optimum Speed: Warp 6
Max. Safe Cruising: Warp 7
Emergency Speed: Warp 8
Max. Speed: Warp 8.4
Destructive Speed: Warp 9.5
Acceleration Power: 3.0
Acceleration Times:
 Warp 1 - Warp 2: 0.130 sec.
 Warp 2 - Warp 3: 0.209 sec.
 Warp 3 - Warp 4: 0.831 sec.
 Warp 4 - Warp 5: 1.134 sec.
 Warp 5 - Warp 6: 1.213 sec.
 Warp 6 - Warp 7: 1.311 sec.
 Warp 7 - Warp 8: 1.682 sec.
 Warp 8 - Warp 9: 2.406 sec.
 Warp 9 - Warp 9.5: 5.347 sec.
 Warp 9.5 - Warp 9.75: N/A
 Warp 9.75 - Warp 9.9: N/A
Duration (Years)
 Standard: 2 Years
 Maximum: 4 Years
Std. Ships Complement: 3
 Crew: 3
 Passengers: 0
 Emergency condition: +0
Transporters Total: 0
 1 Person: 0
 2 Person: 0
 6 Person: 0
 Small Cargo: 0
 Medium Cargo: 0

Tractor Beams: 1
Tow Capacity: 3.20x10²mt
Max Range: 3.30x10¹km
Cargo Specification:
 Standard Cargo Units: N/A
 Cargo Capacity: N/A
Shuttlecraft Specifications:
 Docking Ports: 0
Cloaking Devices: 0
Sensor Index Values:
 Planetary Survey: 1.546
 Stellar Survey: 0.958
Short Range: 1.125
Long Range: 1.060
Navigation: 0.992
Special: 1.948
Computers: 2
Type: Norray-Magne 22:d
Type: Norray-Magne 13:f
Shield Rating:
Holdoff Power: 4.72x10⁸ W
Refresh Rate: 1.34x10⁸ W
Breakdown Rate: 1.61x10⁸ W
Shield Dimensions (Meters)
 Length: 13.21m
 Width: 5.33m
 Height: 3.00m
Weapons:
Weapon Placement:
Beam (Phasers) Total: 2 Mounts
Output: 5.0x10¹⁰ W / 2.5x10⁹ W
Range: 2.5x 10⁵ km
Rate of Fire: 30 ppm / Cont.
Forward Banks: 2
Rear Banks: 0
Port Banks: 0
Starboard Banks: 0
Upper Banks: 0
Lower Banks: 0
Beam (HeavyPhasers) Total: 1
Output: 7.5x10¹⁰ W / 3.75x10⁹ W
Range: 4.0x 10⁵ km
Rate of Fire: 20 ppm / Cont.
Forward/Rear Banks: 1
Port/Starboard Banks: 0
Upper/Lower Banks: 0
Missiles (Photon) Total: 3 Tubes
Stock: 90
Range: 2.0x 10⁵ km
Output: 5-11 Megatons
Rate of Fire: 10 spm
Forward Bay: 3
Rear Bay: 0
Port Bay: 0
Starboard Bay: 0
Upper Bay: 0
Lower Bay: 0

Class Emblem



Hornet Class
Fighter

FEDERATION CRAFT



FIGHTER

HORNET CLASS

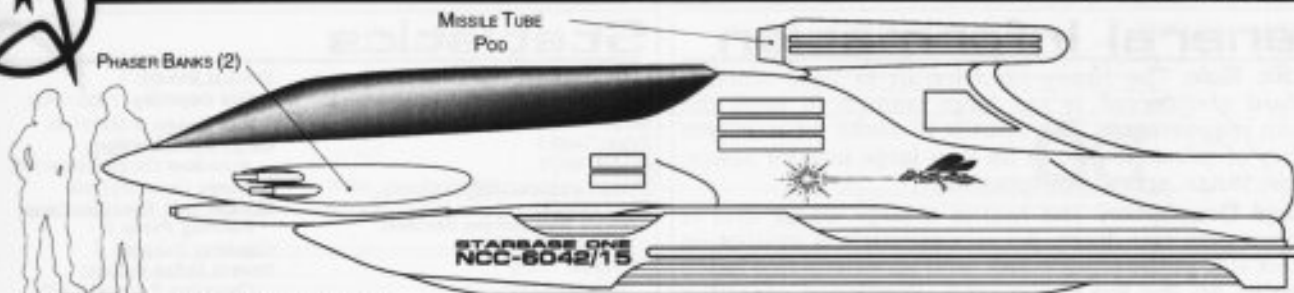

PORT PROFILE

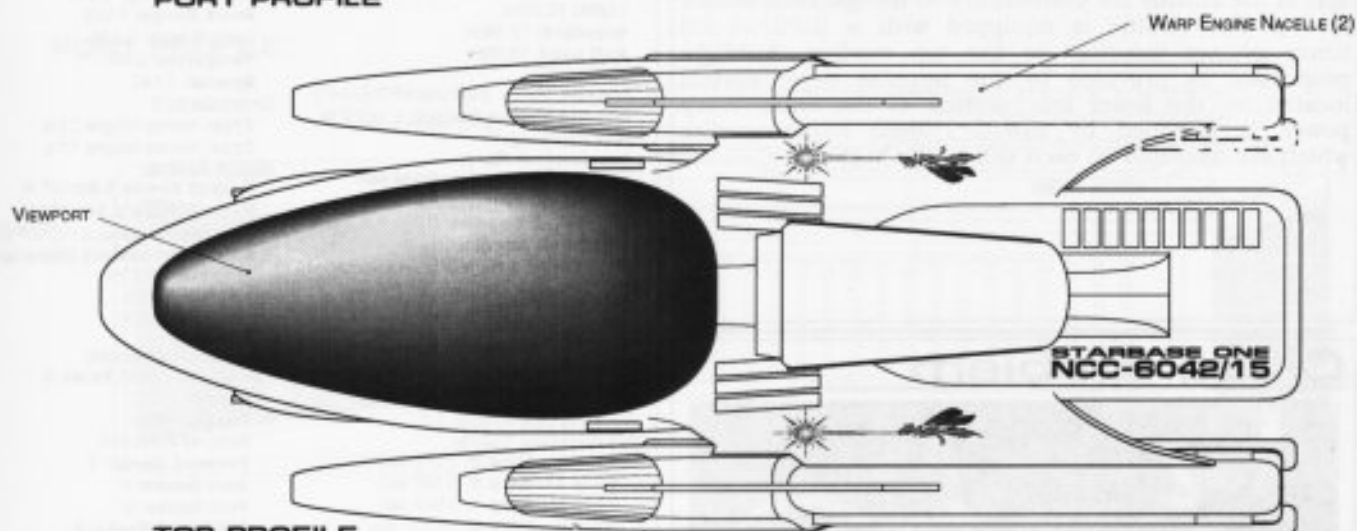

TOP PROFILE

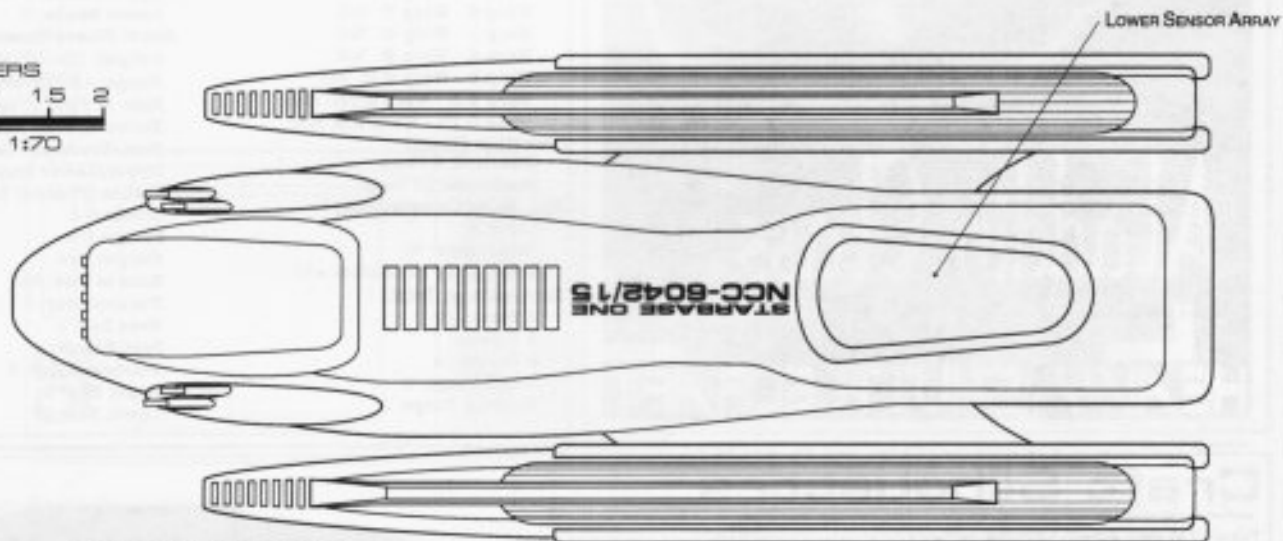

BOTTOM PROFILE

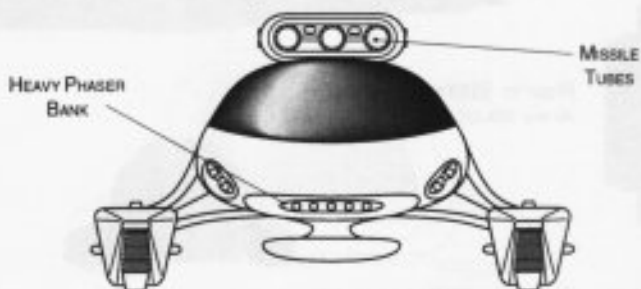

FRONT PROFILE

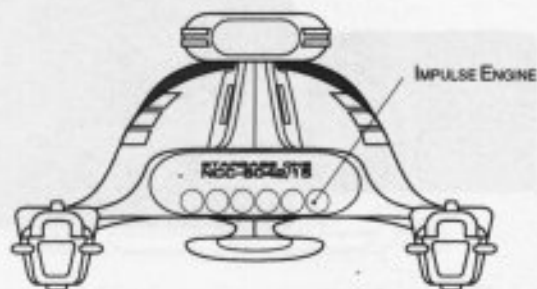

REAR PROFILE

FEDERATION CRAFT

HEAVY SHUTTLECRAFT



ALADDIN CLASS

General Information

Specific Role: The Heavy Shuttlecraft is used when a standard shuttlecraft is not large enough to meet the mission requirements. The Shuttle is useful for a diverse number of missions due to its very large interior space, extreme range, speed and versatility.

Physical Description: The hull is a large wedge and is equipped with two doors. An access hatch is located on the port side of the shuttlecraft, and an emergency hatch is located on the top of the craft. Positioned on either side of the shuttle are (SMDN25/7-4) navigational sensor arrays. The shuttle is equipped with a (BP2/24-3B) heavy phaser mounted in the top cowling. Sublight propulsion is provided by the impulse drive system located on the lower rear section of the craft. Warp power is provided by (SW52/1-5MK) micro-nacelles which are mounted on each side of the hull.

Statistics

Classification: Heavy Shuttlecraft

Category: Shuttlecraft

Class: Aladdin

Type: Class 5

Model: MK-X

Naval Construction Contract: HS-11

Dimensions:

Overall Dimensions (Meters)

Length: 18.17m

Width: 7.02m

Height: 3.71m

Displacement (Metric Tons)

Light: 12.20mt

Standard: 13.56mt

Full Load: 15.59mt

Performance:

Impulse Units: Dual Unit (IP75E/4-IP)

Impulse Engine Output: 1.3×10^6 W

Max Cruising: C

Acceleration Rate:

0.00-0.25 Impulse: 0.144 sec.

0.25-0.50 Impulse: 0.216 sec.

0.50-0.75 Impulse: 0.288 sec.

0.75-Full Impulse: 0.360 sec.

Warp Units: 2 Nacelle Units (SW18/1-4AX)

Warp Engine Output: 2.5×10^7 W

Optimum Speed: Warp 3

Max. Safe Cruising: Warp 4

Emergency Speed: Warp 4.5

Max. Speed: Warp 4.9

Destructive Speed: Warp 5.2

Acceleration Power: 3.0

Acceleration Times:

Warp 1 - Warp 2: 2.572 sec.

Warp 2 - Warp 3: 3.136 sec.

Warp 3 - Warp 4: 5.968 sec.

Warp 4 - Warp 5: 10.231 sec.

Warp 5 - Warp 6: N/A

Warp 6 - Warp 7: N/A

Warp 7 - Warp 8: N/A

Warp 8 - Warp 9: N/A

Warp 9 - Warp 9.5: N/A

Warp 9.5 - Warp 9.75: N/A

Warp 9.75 - Warp 9.9: N/A

Duration (Years)

Standard: 5 Years

Maximum: 20 Years

Std. Ships Complement: 1

Crew: 1

Passengers: 16

Emergency condition: +10

Transporters Total: 1

1 Person: 0

2 Person: 1

6 Person: 0

Small Cargo: 0

Medium Cargo: 0

Tractor Beams: 1

Tow Capacity: 7.82×10^2 mt

Max Range: 9.35×10^3 km

Cargo Specification:

Standard Cargo Units: N/A

Cargo Capacity: N/A

Shuttlecraft Specifications:

Docking Ports: 0

Cloaking Devices: 0

Sensor Index Values:

Planetary Survey: 1.272

Stellar Survey: 0.968

Short Range: 1.123

Long Range: 1.138

Navigation: 0.997

Special: 1.142

Computers: 2

Type: Norray-Magne 21:n

Type: Norray-Magne 17:s

Shield Rating:

Holdoff Power: 5.98×10^6 W

Refresh Rate: 2.34×10^8 W

Breakdown Rate: 2.01×10^8 W

Shield Dimensions (Meters)

Length: 18.17m

Width: 7.02m

Height: 3.71m

Weapons:

Weapon Placement:

Beam (Phasers) Total: 0

Output: N/A

Range: N/A

Rate of Fire: N/A

Forward Banks: 0

Rear Banks: 0

Port Banks: 0

Starboard Banks: 0

Upper Banks: 0

Lower Banks: 0

Beam (HeavyPhasers) Total: 1

Output: 7.5×10^{10} W / 3.75×10^9 W

Range: 4.0×10^5 km

Rate of Fire: 20 ppm / Cont.

Forward/Rear Banks: 1

Port/Starboard Banks: 0

Upper/Lower Banks: 0

Missiles (Photon) Total: N/A

Stock: N/A

Range: N/A

Output: N/A

Rate of Fire: N/A

Forward Bay: 0

Rear Bay: 0

Port Bay: 0

Starboard Bay: 0

Upper Bay: 0

Lower Bay: 0

Class Emblem



FEDERATION CRAFT

Craft Silhouettes

Total Target Area 120.84 m²



Top Silhouette

Area 74.12 m²



Port Silhouette

Area 35.08 m²



Front Silhouette

Area 11.44 m²



HEAVY SHUTTLECRAFT

ALADDIN CLASS

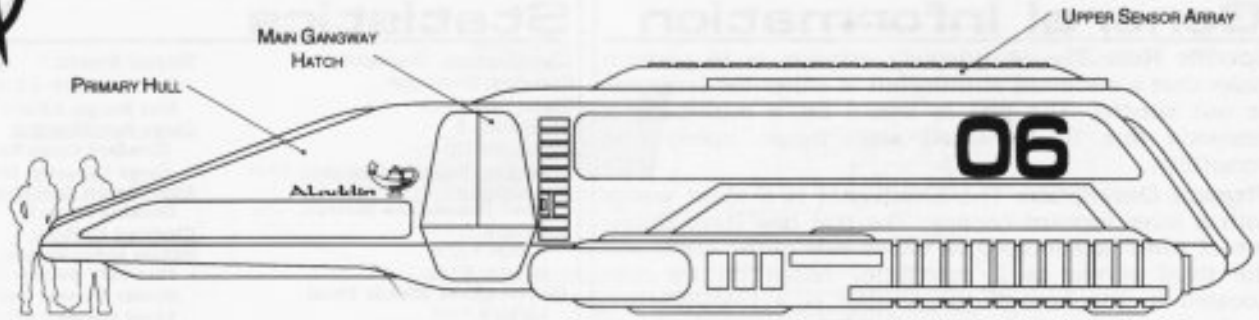

PORT PROFILE

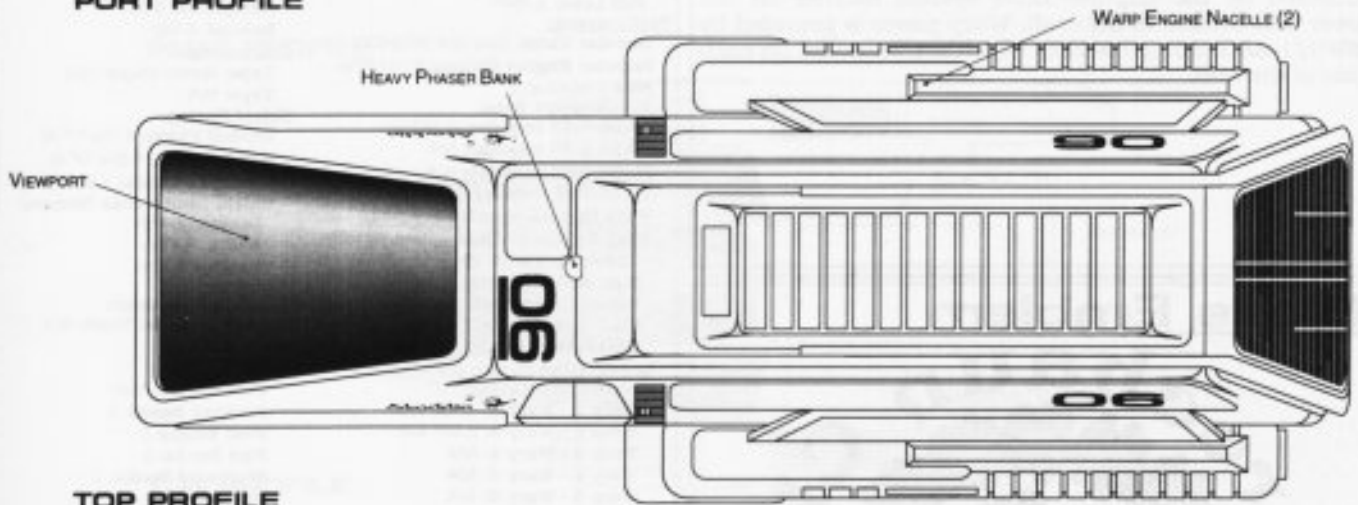

TOP PROFILE

METERS
0 0.5 1 1.5 2
SCALE 1:85

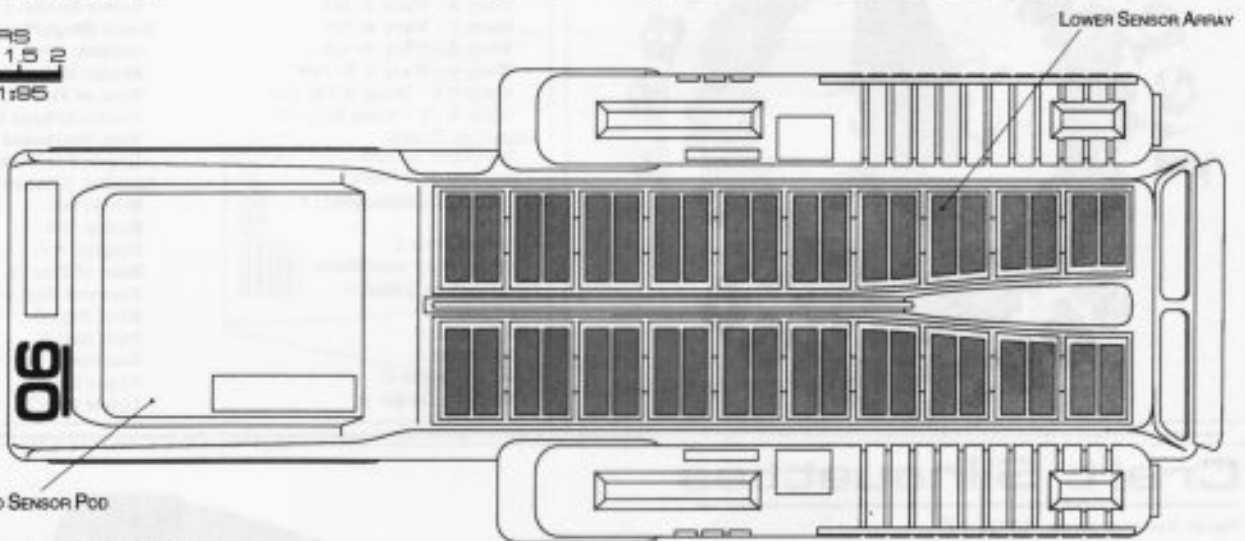

BOTTOM PROFILE



FRONT PROFILE



REAR PROFILE

FEDERATION CRAFT

SHUTTLEPOD



LEPRECHAUN CLASS

General Information

Specific Role: The Shuttlepod's mission is to perform tasks that a standard shuttlecraft is either too large for, or not needed. The pod is useful for a multitude of missions due to its small size, range, speed and versatility.

Physical Description: The Shuttlepod is a short wedge with a large forward canopy. The pod has three doors; two of which are located on either side of the craft, and the third serves as a emergency hatch on the top. Located in the bow of the shuttle is a (SMDN8/3-4) navigational sensor array. Sublight propulsion is provided by the impulse drive system located on the lower rear section of the craft. Warp power is provided by (SW9/1-3AG) micro-nacelles which are mounted on each side of the hull.

Class Emblem



Statistics

Classification: Shuttlepod

Category: Shuttlecraft

Class: Leprechaun

Type: Class 5

Model: MK-VIII

Naval Construction Contract: SP-11

Dimensions:

Overall Dimensions (Meters)

Length: 8.41m

Width: 4.57m

Height: 3.12m

Displacement (Metric Tons)

Light: 2.71mt

Standard: 3.01mt

Full Load: 3.46mt

Performance:

Impulse Units: Dual Unit (ER24D/2-IC)

Impulse Engine Output: 2.1×10^8 W

Max Cruising: C

Acceleration Rate:

0.00-0.25 Impulse: 0.343sec.

0.25-0.50 Impulse: N/A

0.50-0.75 Impulse: N/A

0.75-Full Impulse: N/A

Warp Units: 2 Nacelle Units (CV22/1-2QE)

Warp Engine Output: 1.2×10^7 W

Optimum Speed: Warp 1

Max. Safe Cruising: Warp 2.5

Emergency Speed: Warp 2.8

Max. Speed: Warp 2.9

Destructive Speed: Warp 3.1

Acceleration Power: 3.0

Acceleration Times:

Warp 1 - Warp 2: 2.450 sec.

Warp 2 - Warp 3: 2.987 sec.

Warp 3 - Warp 4: N/A

Warp 4 - Warp 5: N/A

Warp 5 - Warp 6: N/A

Warp 6 - Warp 7: N/A

Warp 7 - Warp 8: N/A

Warp 8 - Warp 9: N/A

Warp 9 - Warp 9.5: N/A

Warp 9.5 - Warp 9.75: N/A

Warp 9.75 - Warp 9.9: N/A

Duration (Years)

Standard: 3 Years

Maximum: 8 Years

Std. Ships Complement: 1

Crew: 1

Passengers: 3

Emergency condition: +2

Transporters Total: 0

1 Person: 0

2 Person: 0

6 Person: 0

Small Cargo: 0

Medium Cargo: 0

Tractor Beams: 1

Tow Capacity: 2.51×10^2 mt

Max Range: 4.20×10^1 km

Cargo Specifications:

Standard Cargo Units: N/A

Cargo Capacity: N/A

Shuttlecraft Specifications:

Docking Ports: 0

Cloaking Devices: 0

Sensor Index Values:

Planetary Survey: 0.825

Stellar Survey: 0.431

Short Range: 0.987

Long Range: 0.225

Navigation: 0.801

Special: 0.852

Computers: 1

Type: Norray-Magne 18y

Type: N/A

Shield Rating:

Holdoff Power: 4.72×10^6 W

Refresh Rate: 1.34×10^6 W

Breakdown Rate: 1.61×10^6 W

Shield Dimensions (Meters)

Length: 8.41m

Width: 4.57m

Height: 3.12m

Weapons:

Weapon Placement:

Beam (Phasers) Total: N/A

Output: N/A

Range: N/A

Rate of Fire: N/A

Forward Banks: 0

Rear Banks: 0

Port Banks: 0

Starboard Banks: 0

Upper Banks: 0

Lower Banks: 0

Beam (MegaPhasers) Total: N/A

Output: N/A

Range: N/A

Rate of Fire: N/A

Forward/Rear Banks: 0

Port/Starboard Banks: 0

Upper/Lower Banks: 0

Missiles (Photon) Total: N/A

Stock: N/A

Range: N/A

Output: N/A

Rate of Fire: 0

Forward Bay: 0

Rear Bay: 0

Port Bay: 0

Starboard Bay: 0

Upper Bay: 0

Lower Bay: 0

Craft Silhouettes

Total Target Area 40.08 m²

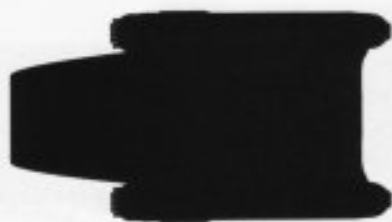

Top Silhouette

Area 21.52 m²



Port Silhouette

Area 12.28 m²



Front Silhouette

Area 6.28 m²

FEDERATION CRAFT



SHUTTLEPOD

LEPRECHAUN CLASS

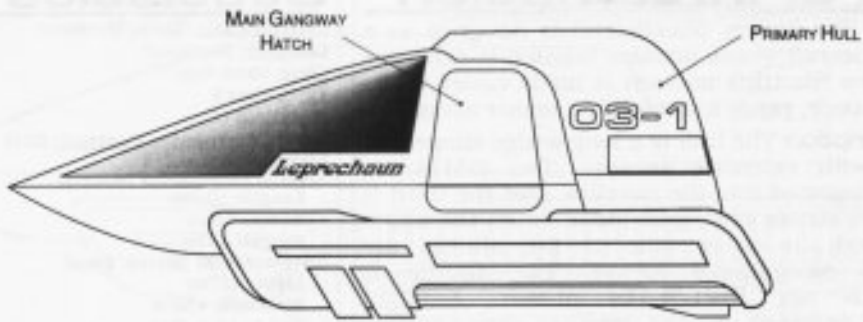

PORT PROFILE

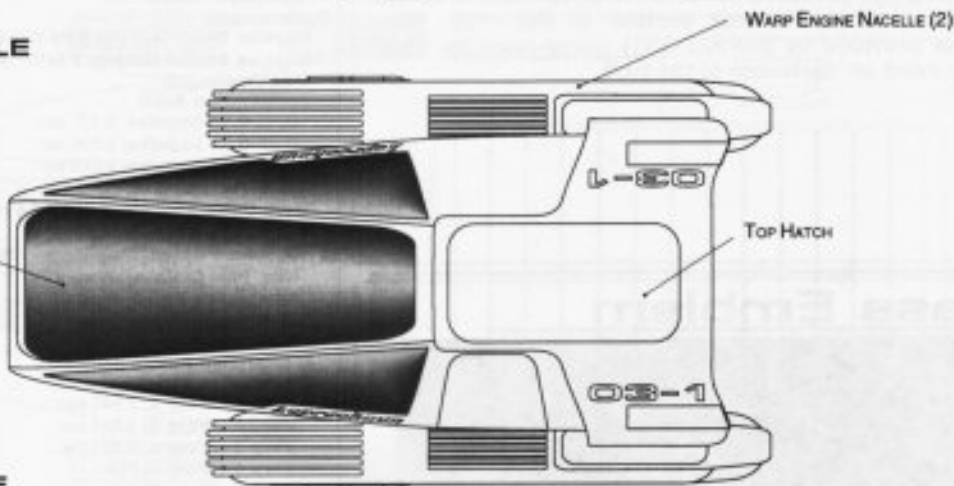

TOP PROFILE

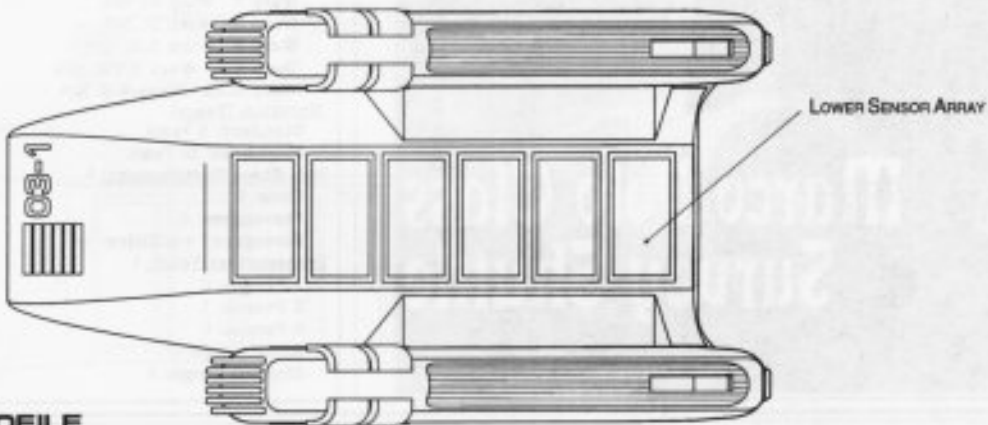

BOTTOM PROFILE

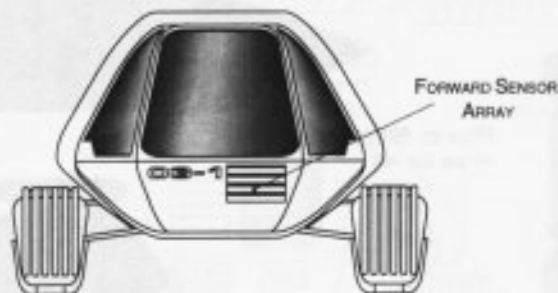

FRONT PROFILE

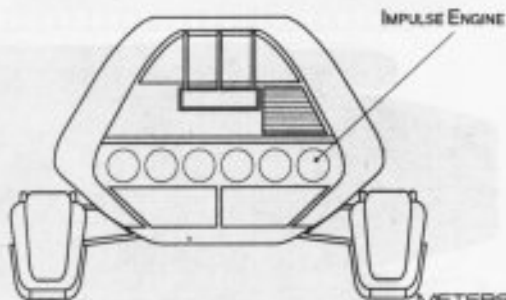

REAR PROFILE

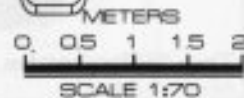

FEDERATION CRAFT

SURVEY SHUTTLE



MARCO POLO CLASS

General Information

Specific Role: The Survey Shuttlecraft is designed as a research shuttlecraft whose primary mission is extensive exploration. The Shuttle's mission is made easier by its large interior space, range and multiple sensor arrays.

Physical Description: The hull is a long wedge shape and is equipped with extensive sensors. Two (SM14/2A) sensors are integrated into the nacelles, and the third is a (SME22/2AP) sensor array pod mounted on the upper hull. Positioned on either side of the shuttle are (SMDN8/5-12) navigational arrays. The shuttle is equipped with one (BP1/6-1D) phaser. Sublight propulsion is provided by the impulse drive system located on the lower rear section of the craft. Warp power is provided by (SW9/1-5ST) micro-nacelles which are mounted on each side of the hull.

Class Emblem



Statistics

Classification: Survey Shuttlecraft
Category: Shuttlecraft
Class: Marco Polo
Type: Class 5
Model: MK-IX
Naval Construction Contract: SS-11
Dimensions:
Overall Dimensions (Meters)
 Length: 10.04m
 Width: 4.95m
 Height: 3.12m
Displacement (Metric Tons)
 Light: 4.07mt
 Standard: 4.52mt
 Full Load: 5.19mt
Performance:
Impulse Units: Dual Unit (ER47D/2-IC)
Impulse Engine Output: 7.8x10⁸ W
Max Cruising: C
Acceleration Rate:
 0.00-0.25 Impulse: 0.137 sec.
 0.25-0.50 Impulse: 0.206 sec.
 0.50-0.75 Impulse: 0.275 sec.
 0.75-Full Impulse: 0.343 sec.
Warp Units: 2 Nacelle Units (CV54/1-2QE)
Warp Engine Output: 1.2x10⁷ W
Optimum Speed: Warp 2
Max. Safe Cruising: Warp 3
Emergency Speed: Warp 4
Max. Speed: Warp 4.1
Destructive Speed: Warp 4.3
Acceleration Power: 3.0
Acceleration Times:
 Warp 1 - Warp 2: 2.940 sec.
 Warp 2 - Warp 3: 3.584 sec.
 Warp 3 - Warp 4: 6.821 sec.
 Warp 4 - Warp 5: N/A
 Warp 5 - Warp 6: N/A
 Warp 6 - Warp 7: N/A
 Warp 7 - Warp 8: N/A
 Warp 8 - Warp 9: N/A
 Warp 9 - Warp 9.5: N/A
 Warp 9.5 - Warp 9.75: N/A
 Warp 9.75 - Warp 9.9: N/A
Duration (Years)
 Standard: 5 Years
 Maximum: 20 Years
Std. Ships Complement: 1
Crew: 2
Passengers: 4
Emergency condition: +4
Transporters Total: 1
 1 Person: 0
 2 Person: 1
 6 Person: 0
Small Cargo: 0
Medium Cargo: 0

Tractor Beams: 1
Tow Capacity: 4.80x10²mt
Max Range: 6.21x10³km
Cargo Specification:
Standard Cargo Units: N/A
Cargo Capacity: N/A
Shuttlecraft Specifications:
Docking Ports: 0
Cloaking Devices: 0
Sensor Index Values:
Planetary Survey: 1.561
Stellar Survey: 1.025
Short Range: 1.325
Long Range: 1.025
Navigation: 1.023
Special: 1.245
Computers: 2
Type: Norray-Magne 34:k
Type: Norray-Magne 21:c
Shield Rating:
Holdoff Power: 4.85x10⁸ W
Refresh Rate: 1.47x10⁸ W
Breakdown Rate: 1.72x10⁸ W
Shield Dimensions (Meters)
 Length: 12.05m
 Width: 5.94m
 Height: 3.74m
Weapons:
Weapon Placement:
Beam (Phasers) Total: 1 Mounts
Output: 5.0x10⁸ W / 2.5x10⁹ W
Range: 2.5x 10³ km
Rate of Fire: 20 ppm / Cont.
Forward Banks: 1
Rear Banks: 0
Port Banks: 0
Starboard Banks: 0
Upper Banks: 0
Lower Banks: 0
Beam (HeavyPhasers) Total: 0
Output: N/A
Range: N/A
Rate of Fire: N/A
Forward/Rear Banks: 0
Port/Starboard Banks: 0
Upper/Lower Banks: 0
Missiles (Photon) Total: N/A
Stock: N/A
Range: N/A
Output: N/A
Rate of Fire: N/A
Forward Bay: 0
Rear Bay: 0
Port Bay: 0
Starboard Bay: 0
Upper Bay: 0
Lower Bay: 0

Craft Silhouettes

Total Target Area 75.38 m²



Top Silhouette
Area 43.84 m²



Port Silhouette
Area 22.44 m²



Front Silhouette
Area 9.28 m²

FEDERATION CRAFT



SURVEY SHUTTLE

MARCO POLO CLASS

FEDERATION CRAFT

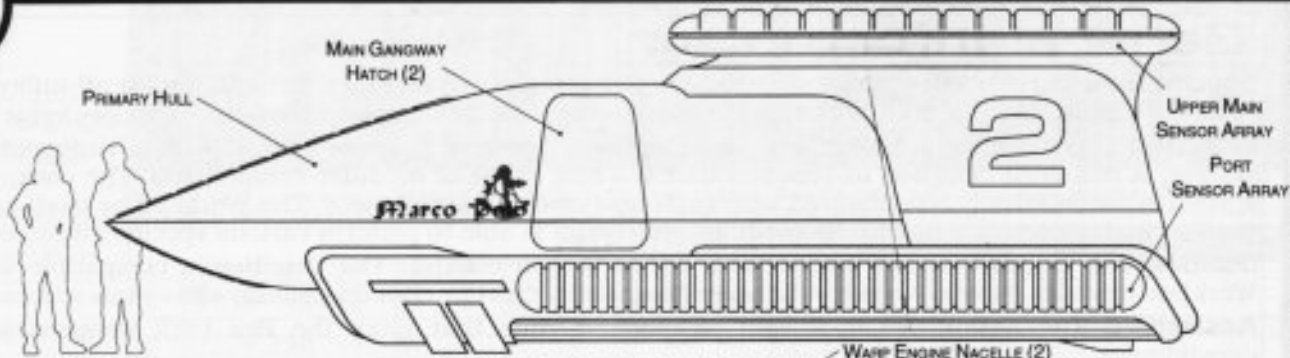

PORT PROFILE

FRONT UPPER
SENSOR ARRAY
VIEWPORT

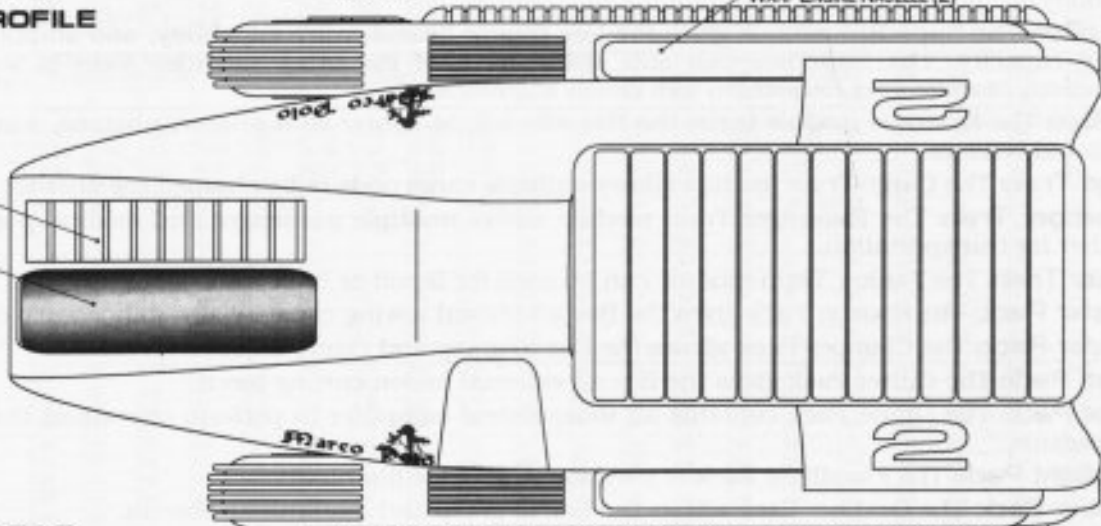

TOP PROFILE

METERS
0 0.5 1 1.5 2
SCALE 1:70

FRONT LOWER
SENSOR ARRAY

PHASER BANK

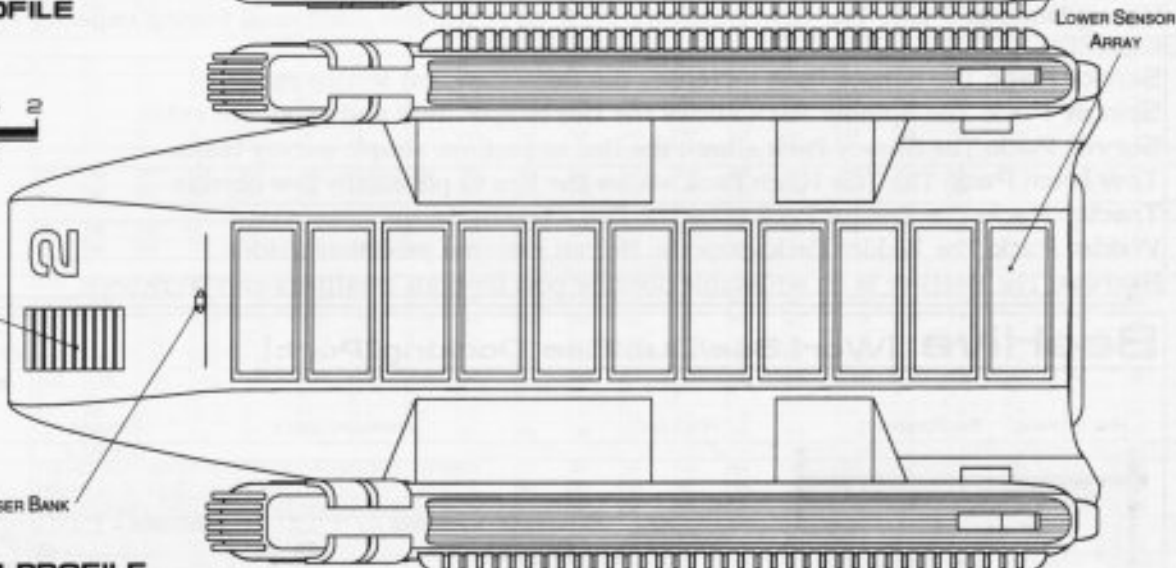

BOTTOM PROFILE

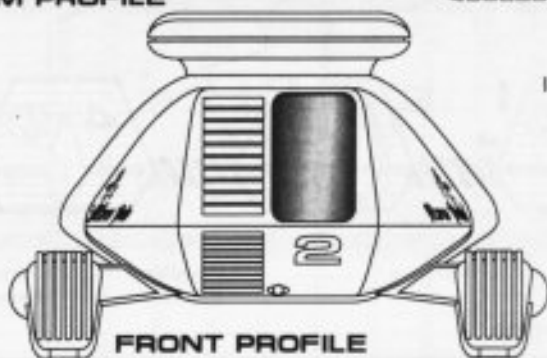

FRONT PROFILE

IMPULSE ENGINE



REAR PROFILE

GENERAL UTILITY CRAFT



WORKBEE CLASS

General Information

Specific Role: The WorkBee family of general utility vehicles are designed to fulfill almost all utility craft roles. This family of craft is based on a modular system built around the basic WorkBee vehicle.

WorkBee: The WorkBee is basically a single operator, general purpose cockpit with a rudimentary drive system. It has been designed to accommodate a whole range of modular components. The cockpit control system is automatically reconfigured with each new modular attachment. The WorkBee by itself is no more than a viewing cockpit, but with its modules attached it is able to perform various specific missions.

DualBee: The DualBee is a WorkBee with a two person cockpit. The DualBee is compatible with most WorkBee modules (Refer to WorkBee Attachment Compatibility Chart for exact compatibility with various attachments).

AssaultBee: The AssaultBee is a light weapons module that gives the Bee both weapons and warp capability.

SuperBee: The SuperBee module gives the Bee tractor beams, warp capability, and additional sensors and towing capacity. The SuperBee can still utilize most of the other modules (Refer to WorkBee Attachment Compatibility Chart for exact compatibility with various attachments).

KillerBee: The KillerBee module turns the Bee into a light fighter with phaser, photons, warp capability and additional sensors.

Cargo Train: The Cargo Train module allows multiple cargo pods to be chained together for transportation.

Passenger Train: The Passenger Train module allows multiple passenger and medical pods to be chained together for transportation.

Tanker Train: The Tanker Train module can be used for liquid or bulk transport.

Booster Pack: The Booster Pack gives the Bee additional towing capacity and minor warp capability.

Clamper Pack: The Clamper Pack allows the Bee to grasp and clamp objects.

Cutter Pack: The Cutter Pack gives the Bee an external fusion cutting torch.

Drone Pack: The Drone Pack contains an independent computer to perform operations that do not require an operator.

Floodlight Pack: The Floodlight Pack is used for large scale illumination.

Grabber Pack: The Grabber Pack allows the Bee to grasp and manipulate objects.

Heavy Booster Pack: The Heavy Booster Pack gives the Bee additional towing capacity and medium warp capability.

Sensor Pack: The Sensor Pack increases the Bees standard sensor range.

Spinner Pack: The Spinner Pack allows the Bee to spot weld and spool out cable.

Survey Pack: The Survey Pack allows the Bee to perform simple survey tasks.

Tow Hitch Pack: The Tow Hitch Pack allows the Bee to physically tow objects.

Tractor Pack: The Tractor Pack gives the Bee a tractor beam.

Welder Pack: The Welder Pack gives the Bee an external precision welder.

BeeHive: The BeeHive is an adjustable docking port for both DualBees and WorkBees.

BeeHive [WorkBee/DualBee Docking Port]

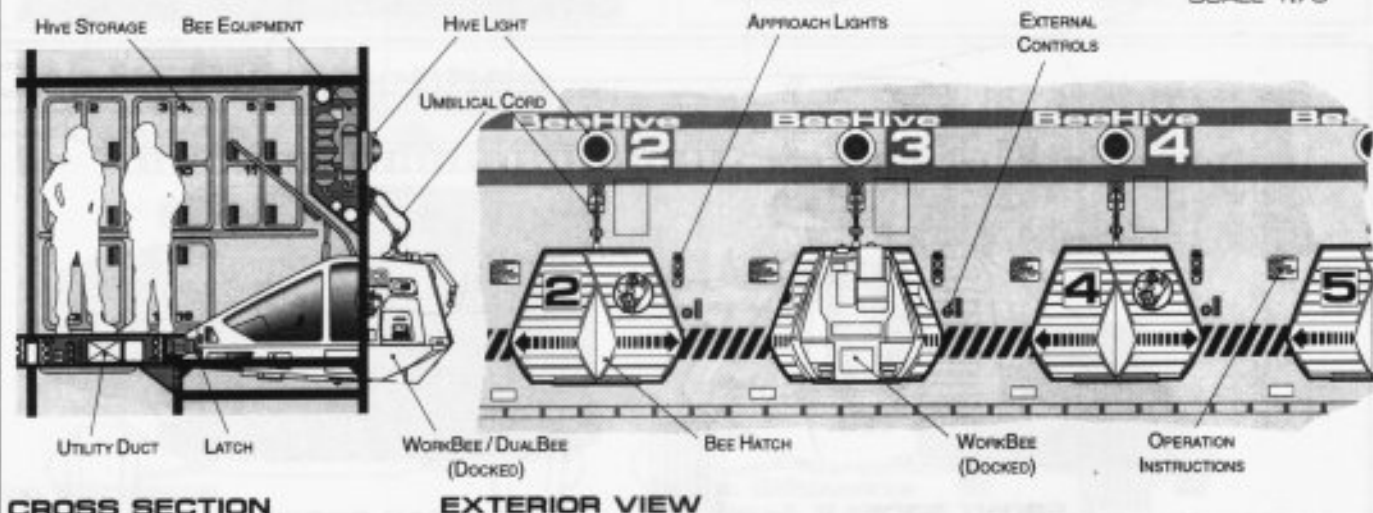
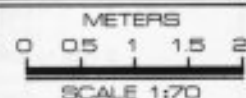

CROSS SECTION

EXTERIOR VIEW

FEDERATION CRAFT

GENERAL UTILITY CRAFT



WORKBEE CLASS

WorkBee

METERS
0 0.5 1 1.5 2
SCALE 1:70

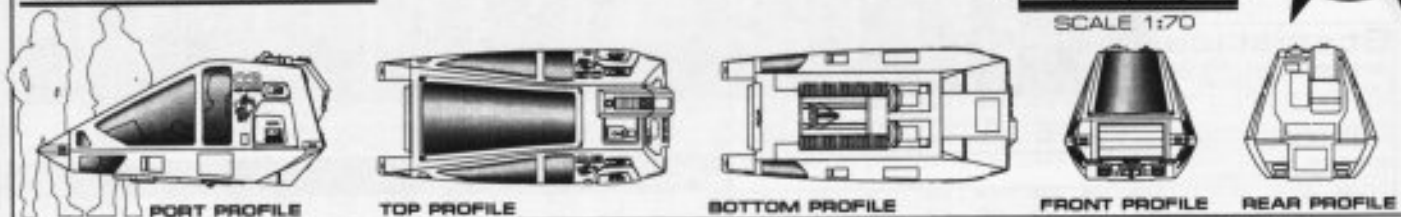

WorkBee

Enlarged for Clarity

METERS
0 0.5 1
SCALE 1:35

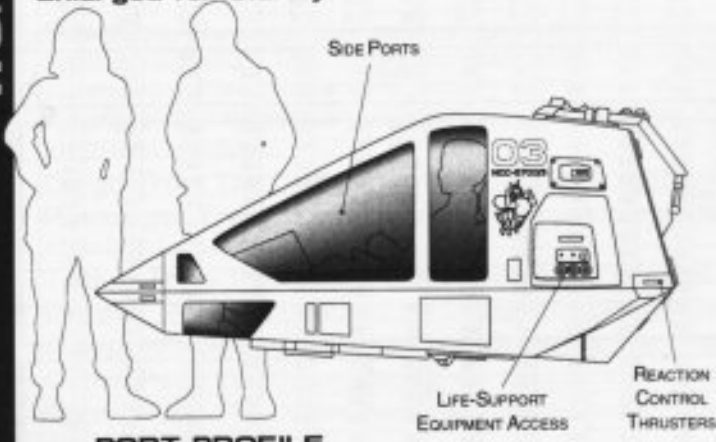

PORT PROFILE

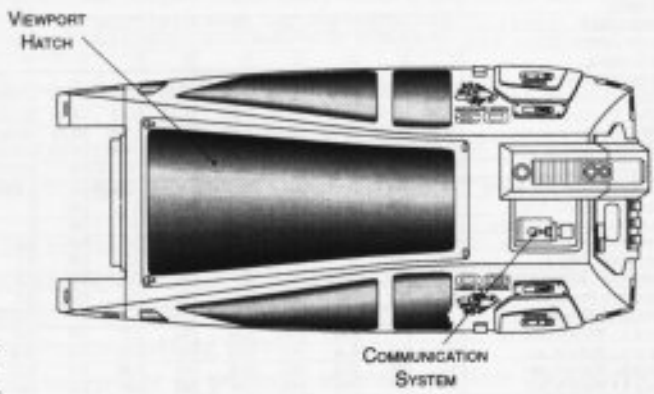

BOTTOM PROFILE

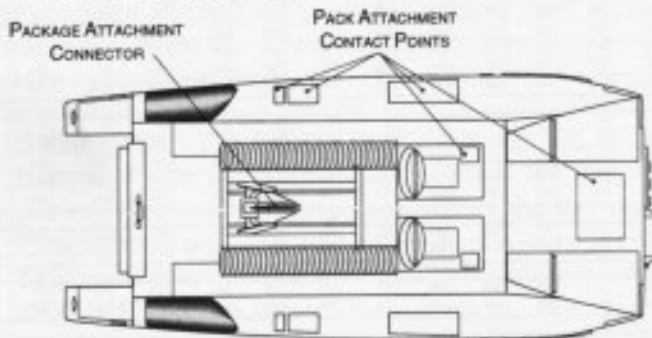

TOP PROFILE

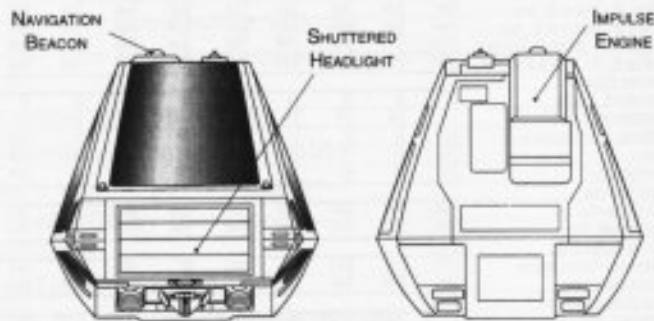

REAR PROFILE

FRONT PROFILE

FEDERATION CRAFT

Class Emblem



Craft Silhouettes

Total Target Area 8.28 m²

Front Silhouette
Area 1.15 m²

Port Silhouette
Area 2.22 m²

Top Silhouette
Area 2.91 m²



GENERAL UTILITY CRAFT

WORKBEE CLASS

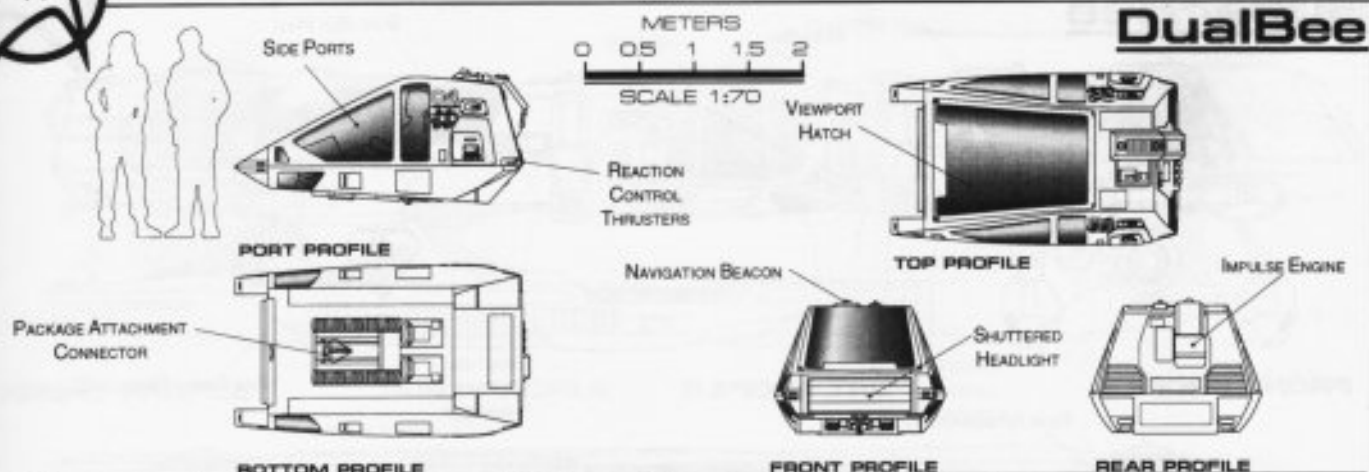

Class Emblem



DualBee

Craft Silhouettes

Total Target Area 7.53 m²



Front Silhouette
Area 1.58 m²



Port Silhouette
Area 2.22 m²



Top Silhouette
Area 3.75 m²

AssaultBee

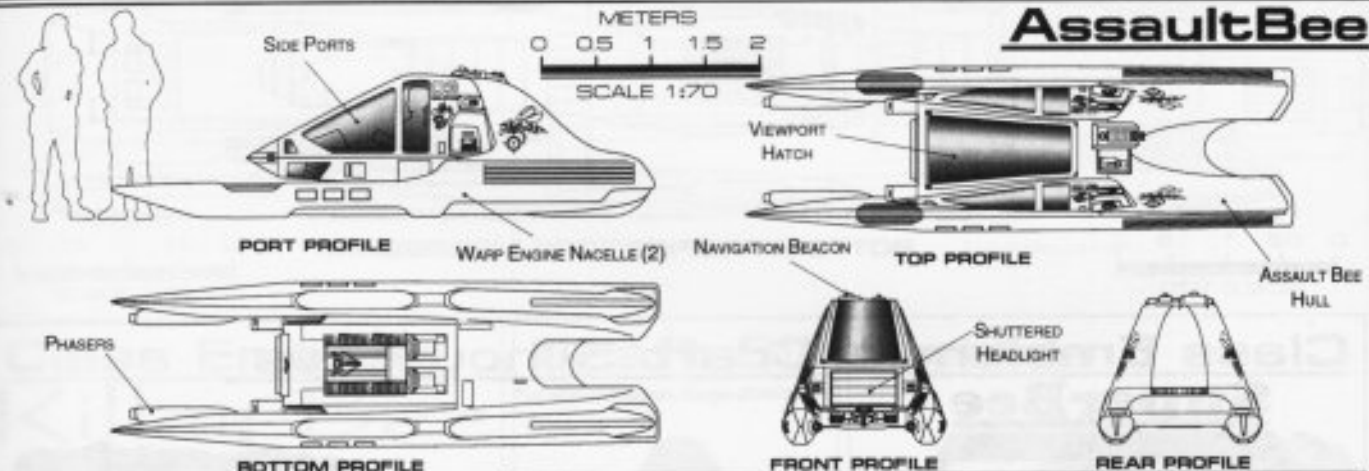

Class Emblem



Craft Silhouettes

Total Target Area 10.92 m²



Front Silhouette
Area 1.39 m²



Port Silhouette
Area 3.85 m²



Top Silhouette
Area 5.68 m²

FEDERATION CRAFT

GENERAL UTILITY CRAFT



WORKBEE CLASS

SuperBee

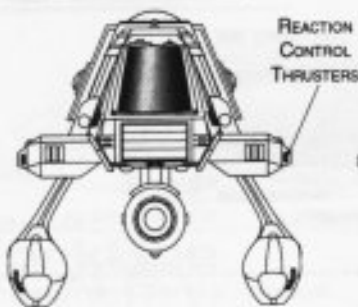

FRONT PROFILE

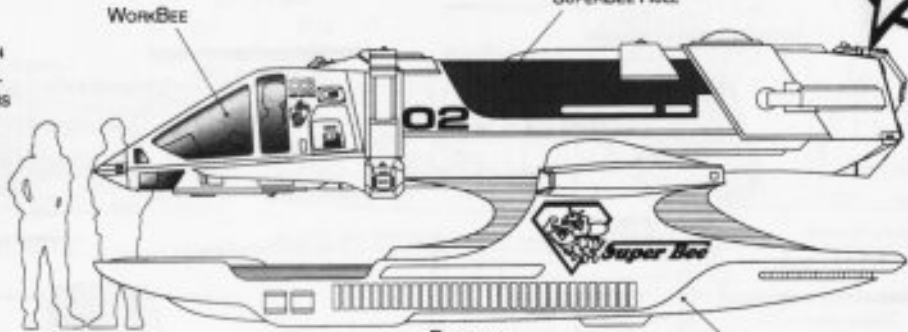

PORT PROFILE

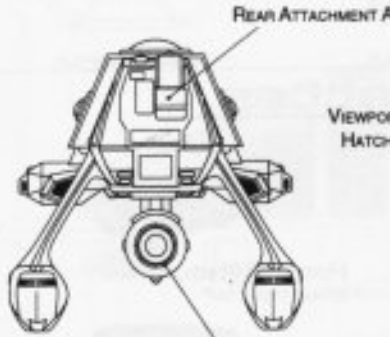

REAR PROFILE

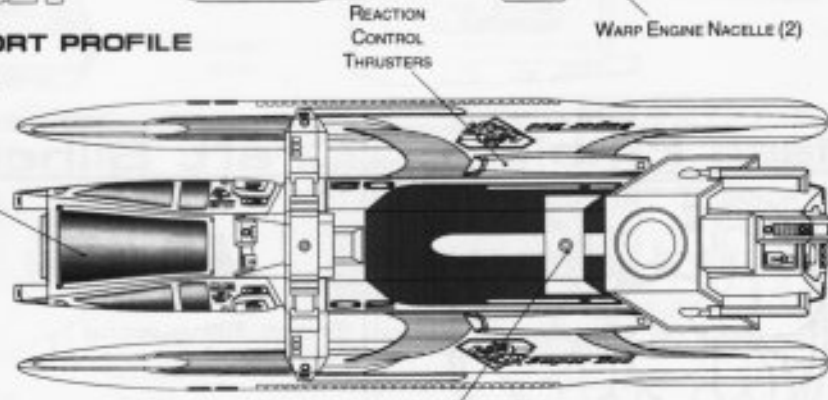

TOP PROFILE

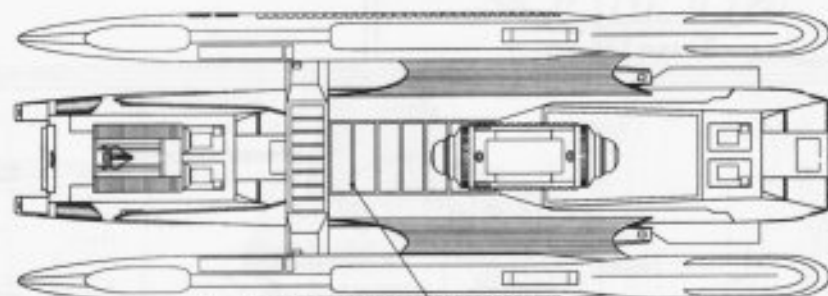

BOTTOM PROFILE



Class Emblem SuperBee



Craft Silhouettes

Total Target Area 33.33 m²



Front Silhouette
Area 3.24 m²



Port Silhouette
Area 13.45 m²



Top Silhouette
Area 16.64 m²

FEDERATION CRAFT



GENERAL UTILITY CRAFT

KillerBee

WORKBEE CLASS



FRONT PROFILE

REACTION CONTROL THRUSTERS



PORT PROFILE

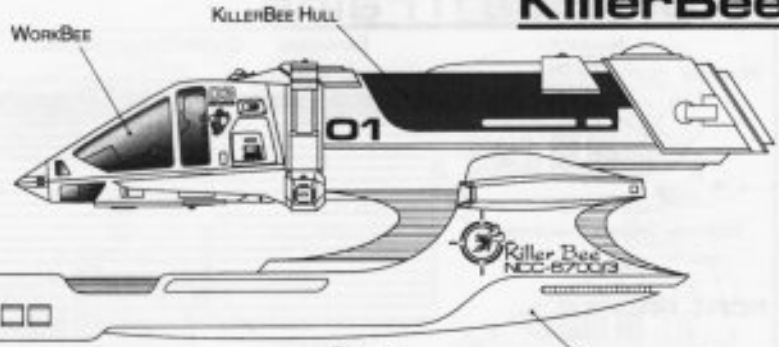

WorkBee

KILLERBEE HULL

REACTION CONTROL THRUSTERS

WARP ENGINE NACELLE (2)

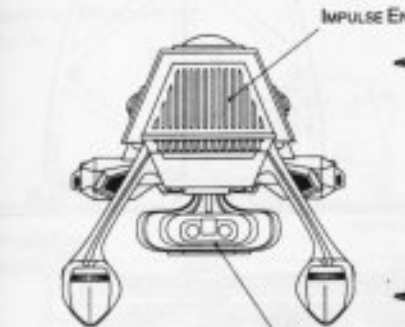

REAR PROFILE

IMPULSE ENGINE

WEAPONS POD

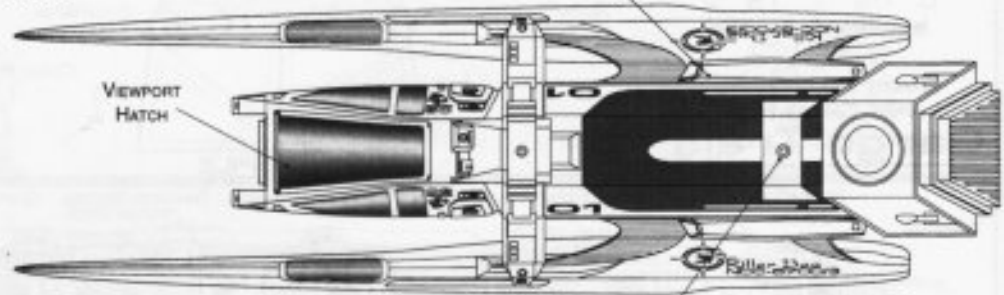

TOP PROFILE

VIEWPORT HATCH

NAVIGATION BEACON

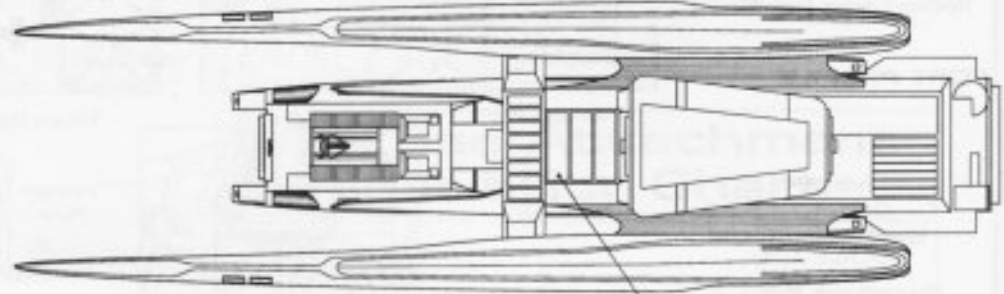

BOTTOM PROFILE

LOWER SENSOR ARRAY



Class Emblem KillerBee



Craft Silhouettes

Total Target Area 38.09 m²



Front Silhouette
Area 3.43 m²



Port Silhouette
Area 12.71 m²



Top Silhouette
Area 15.95 m²

FEDERATION CRAFT

GENERAL UTILITY CRAFT



WORKBEE CLASS

WorkBee Trains

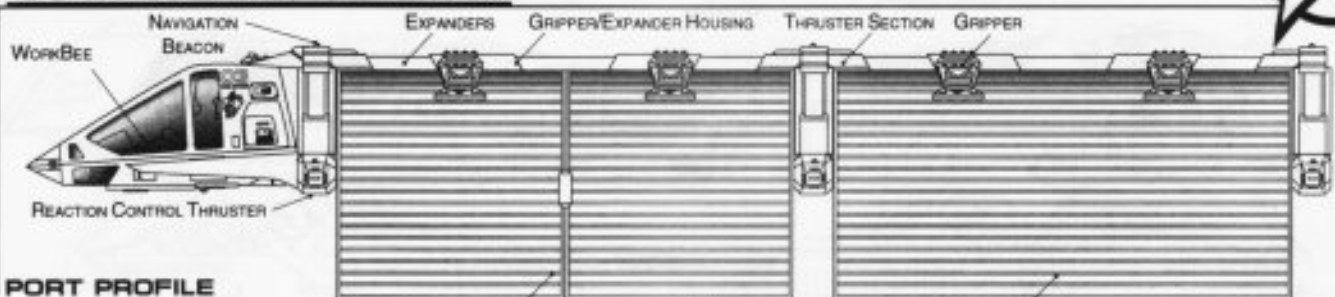

PORT PROFILE

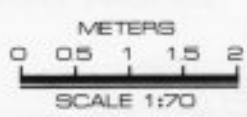

CARGO POD
LARGE CARGO POD
Cargo Train

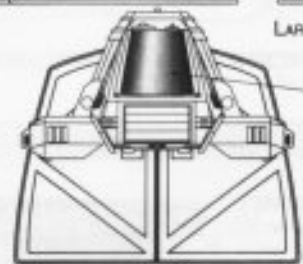

FRONT PROFILE

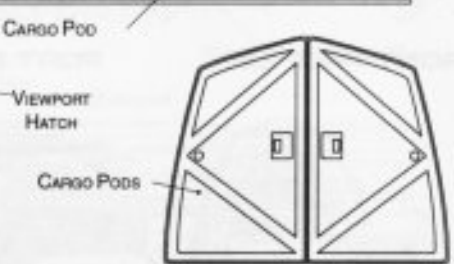

POD FRONT PROFILE

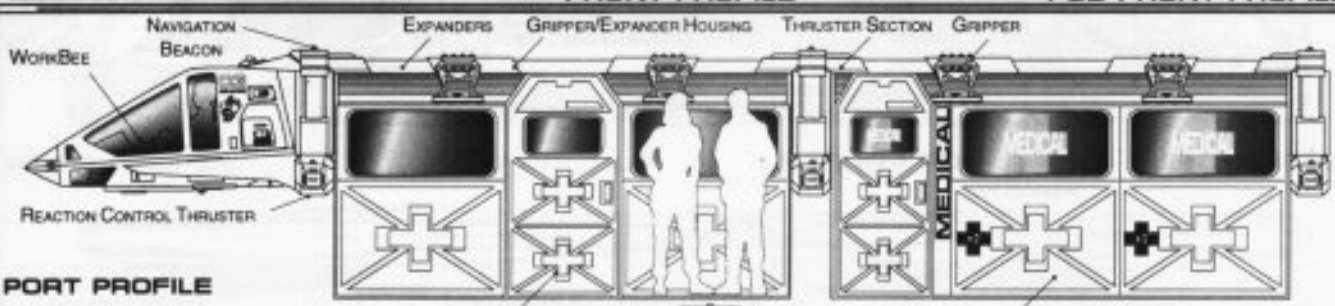

PORT PROFILE

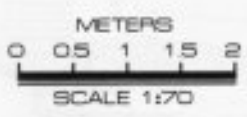

PASSENGER POD
MEDICAL POD
Passenger Train

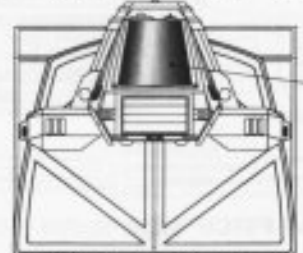

FRONT PROFILE

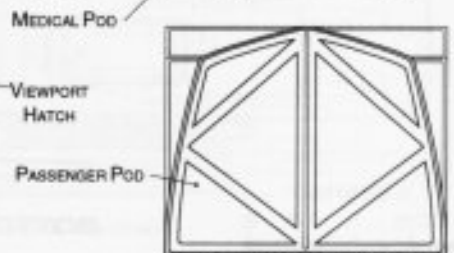

POD FRONT PROFILE

FEDERATION CRAFT

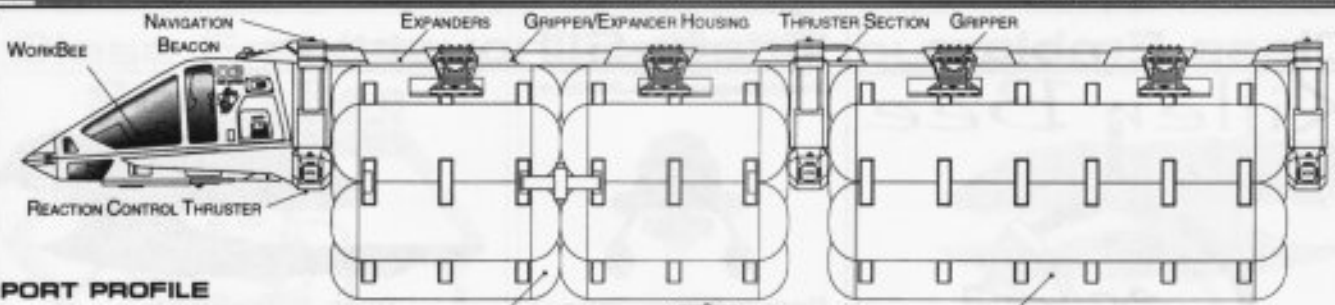

PORT PROFILE



TANKER POD
LARGE TANKER POD
Tanker Train

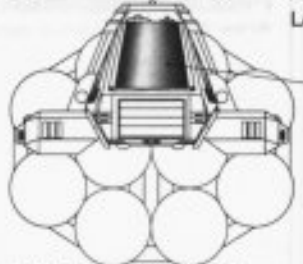

FRONT PROFILE

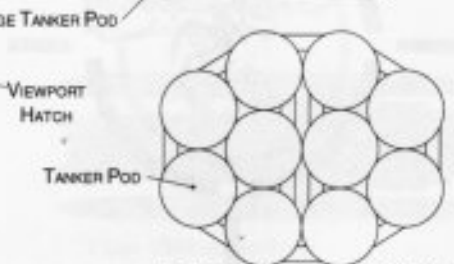

POD FRONT PROFILE



GENERAL UTILITY CRAFT

Bee Packs

WORKBEE CLASS



Booster Pack

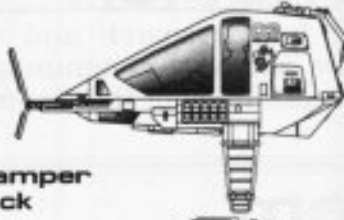

Clamper Pack



Cutter Pack



Heavy Booster Pack



Drone Pack



Floodlight Pack



Grabber Pack



Sensor Pack



Spinner Pack



Survey Pack



Tractor Pack



Welder Pack



Tow Hitch Pack

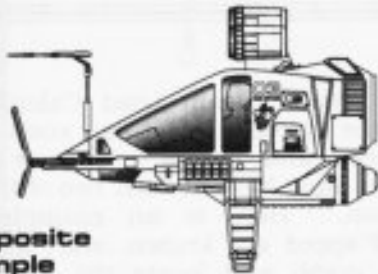

Composite Example

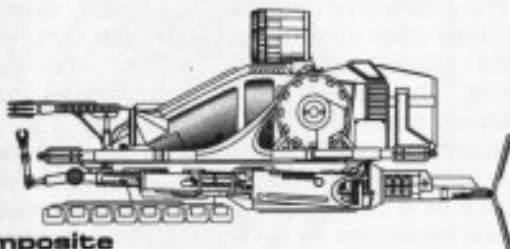

Composite Example 2

WorkBee Attachment Compatibility Chart



	Dual Bee	Work Bee	Assault Bee	Cargo Train	Killer Bee	Passenger Train	Super Bee	Tanker Train	Booster Pack	Clamper Pack	Cutter Pack	Drone Pack	Floodlight Pack	Grabber Pack	Heavy Booster Pack	Sensor Pack	Spinner Pack	Survey Pack	Tow Hitch Pack	Tractor Pack	Welder Pack	
Dual Bee																						
Work Bee																						
Assault Bee																						
Cargo Train																						
Killer Bee																						
Passenger Train																						
Super Bee																						
Tanker Train																						
Booster Pack																						
Clamper Pack																						
Cutter Pack																						
Drone Pack																						
Floodlight Pack																						
Grabber Pack																						
Heavy Booster Pack																						
Sensor Pack																						
Spinner Pack																						
Survey Pack																						
Tow Hitch Pack																						
Tractor Pack																						
Welder Pack																						

A:Adapter Required T:In Tow R:Repositioned I:Impaired Use

FEDERATION CRAFT



SPACE STATIONS

GENERAL INFORMATION

General Information

The Space Station missions include both research and support functions for the Federation. Research platforms, trade stations, communication arrays and spacedocks are needed to supplement the planetside resources of the Federation throughout the expanses of space.

Division Emblem



Tractor Beam

FEDERATION FACILITY

Tractor Beam Specifications

Primary Tractor Beam Load Calculator

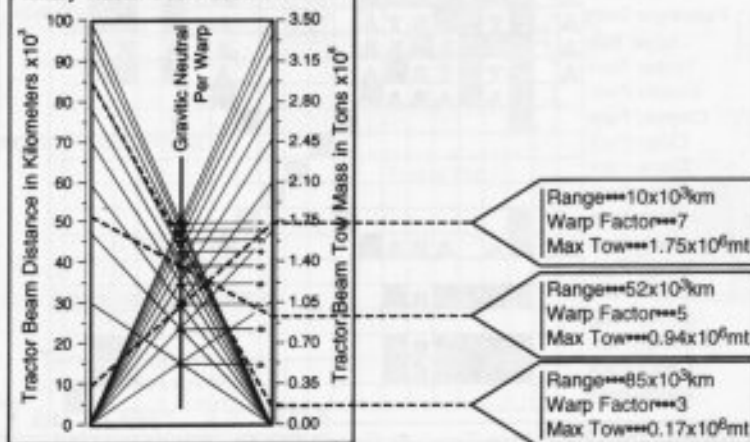

To use the Tractor Beam Load Calculator determine the needed factors such as distance, speed and weight. To use the calculator you must have at least two of these factors known. Here is an example, if distance and speed are known, start at the right of the graph and locate the distance mark for the range. Then look to the center to find the gravitic neutral for that speed, draw a line from the distance mark through the correct speed marking. Where the line crosses the mass line determines the maximum mass that can be towed at a given speed and range. The calculator can be used in the opposite direction to find the maximum distance or if range and distance are known a line can be drawn to determine the maximum speed that can be obtained. Each starship is unique in its distance to mass towing ratio.

SPACE STATIONS

GENERAL INFORMATION

FEDERATION FACILITY

Size Comparison



Communication Station



Trading Station

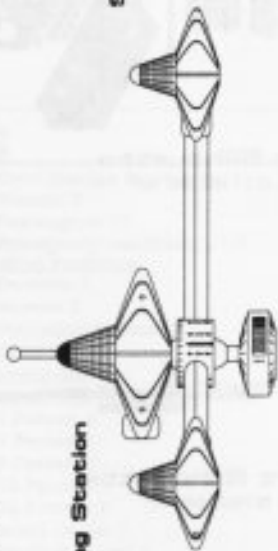

Spacelab



Spacedeck

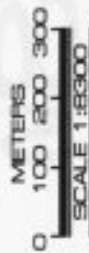
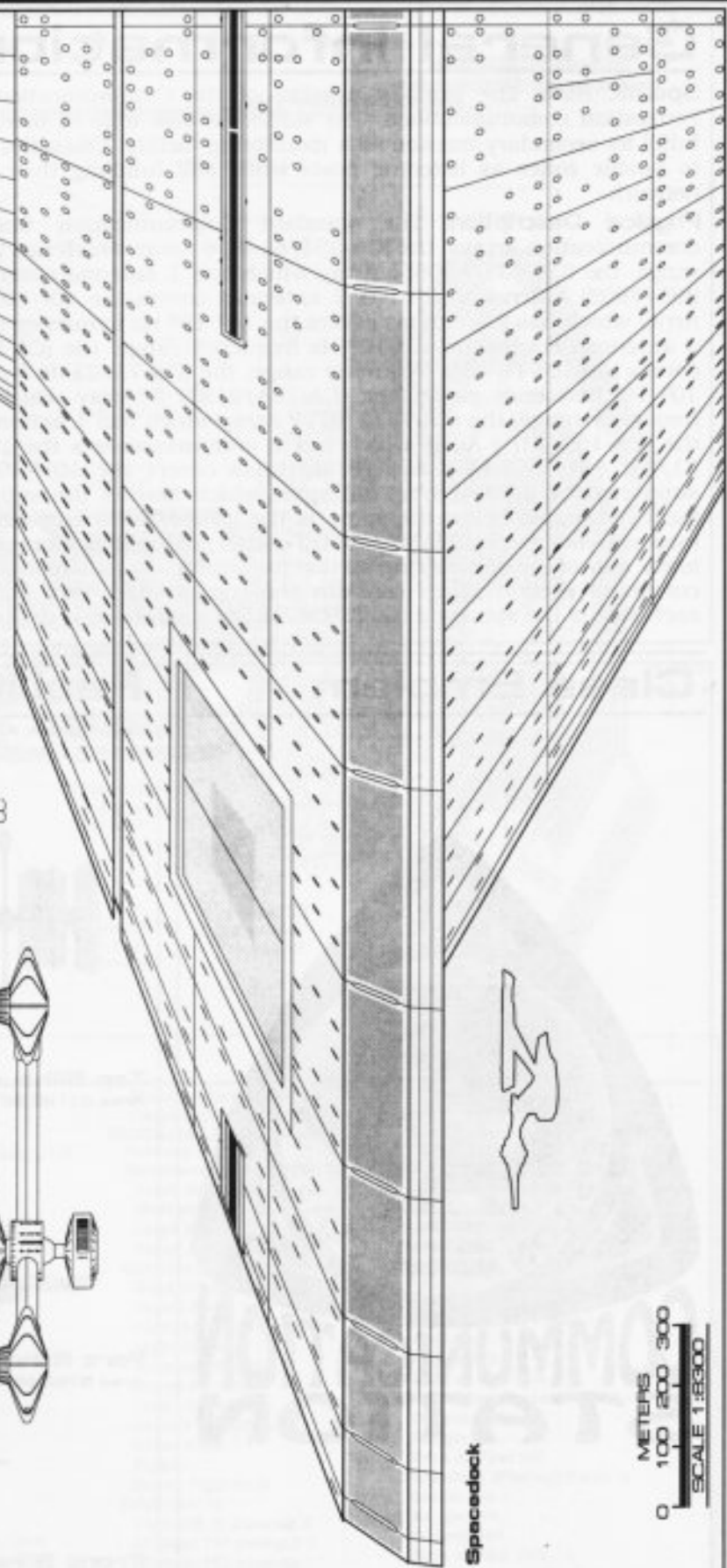

COMMUNICATION STATION



EPSILON CLASS

General Information

Specific Role: The primary mission of the Communication Station is the relaying and boosting of Federation communications. The station is also able to monitor communications and signals, letting it fulfill its secondary mission as a monitoring facility. Often the relay locations are set up in close proximity to hostile zones as listening posts while still fulfilling their role within the Federation communication network.

Physical Description: The standard Communication Station has 42 antennas making up 11 communication arrays: the (CA-254/8146) ϕ Array which has 2 antennas covers the 10^{-2} - 10^1 Hz frequency range, the (CA-138/8008) ξ Array which has 1 antenna covers the 10^5 - 10^7 Hz frequency range, the (CA-995/7995) λ Array which has 2 antennas covers the 10^1 - 10^3 Hz frequency range, the (CA-894/4118) ω Array which has 2 antennas covers the 10^3 - 10^4 Hz frequency range, the (CA-256/2401) α Array which has of 1 antenna covers the 10^9 - 10^{11} Hz frequency range, the (CA-71/2248) θ Array which has 2 antennas covers the 10^7 - 10^9 Hz frequency range, the (CA-134/2187) β Array which has 1 antenna covers the 10^{13} - 10^{15} Hz frequency range, the (CA-78/2187) χ Array which has 1 antenna covers the 10^{11} - 10^{13} Hz frequency range, the (CA-152/71) γ Array which has 2 antennas covers the 10^{15} - 10^{18} Hz frequency range, and the (CA-21/24) ϕ Array which has 16 antennas covers the 10^{18} - 10^{22} Hz frequency range. The antennas are supported by a (SS438/S-C34) spine which houses the support equipment and living quarters for the facility. Located below the spine is the (SH48/S-S2) engineering section which contains the (M8/4-2C) intermix chamber and (AM8/48-4E) matter/antimatter storage tanks. These tanks are located towards the lower rear of the engineering section for emergency jettisoning. Located above the spine is the (SH22/C-S1) command section which contains the command/control and communication equipment. Positioned to each side of the spine are two (SH36/H-S5) small hangar decks located away from the sensor arrays.

Class Emblem



Facility Silhouettes

Total Target Area 71381.07 m²

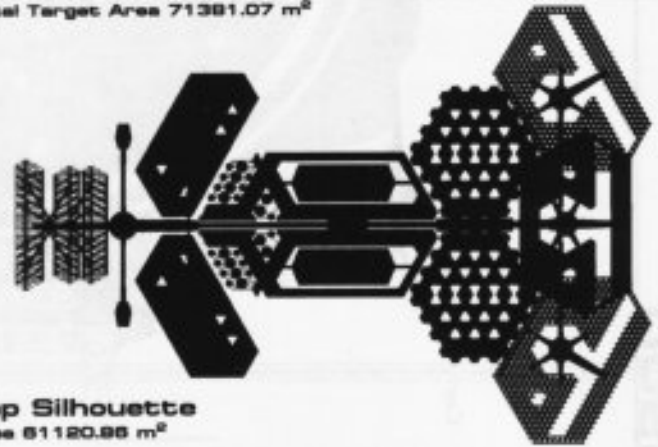

Top Silhouette
Area 61120.96 m²



Port Silhouette
Area 5796.96 m²



Front Silhouette
Area 4473.25 m²

FEDERATION FACILITY



COMMUNICATION STATION

EPSILON CLASS

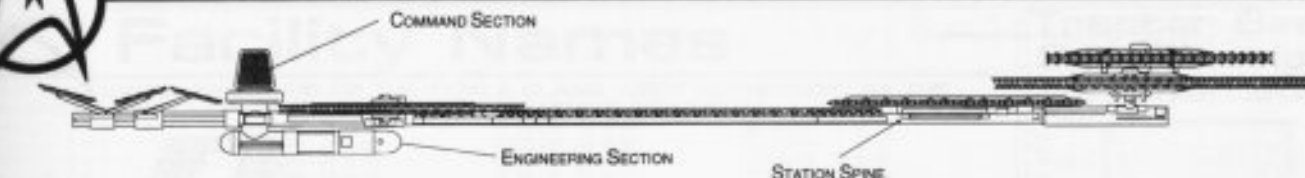

PORT PROFILE



TOP PROFILE

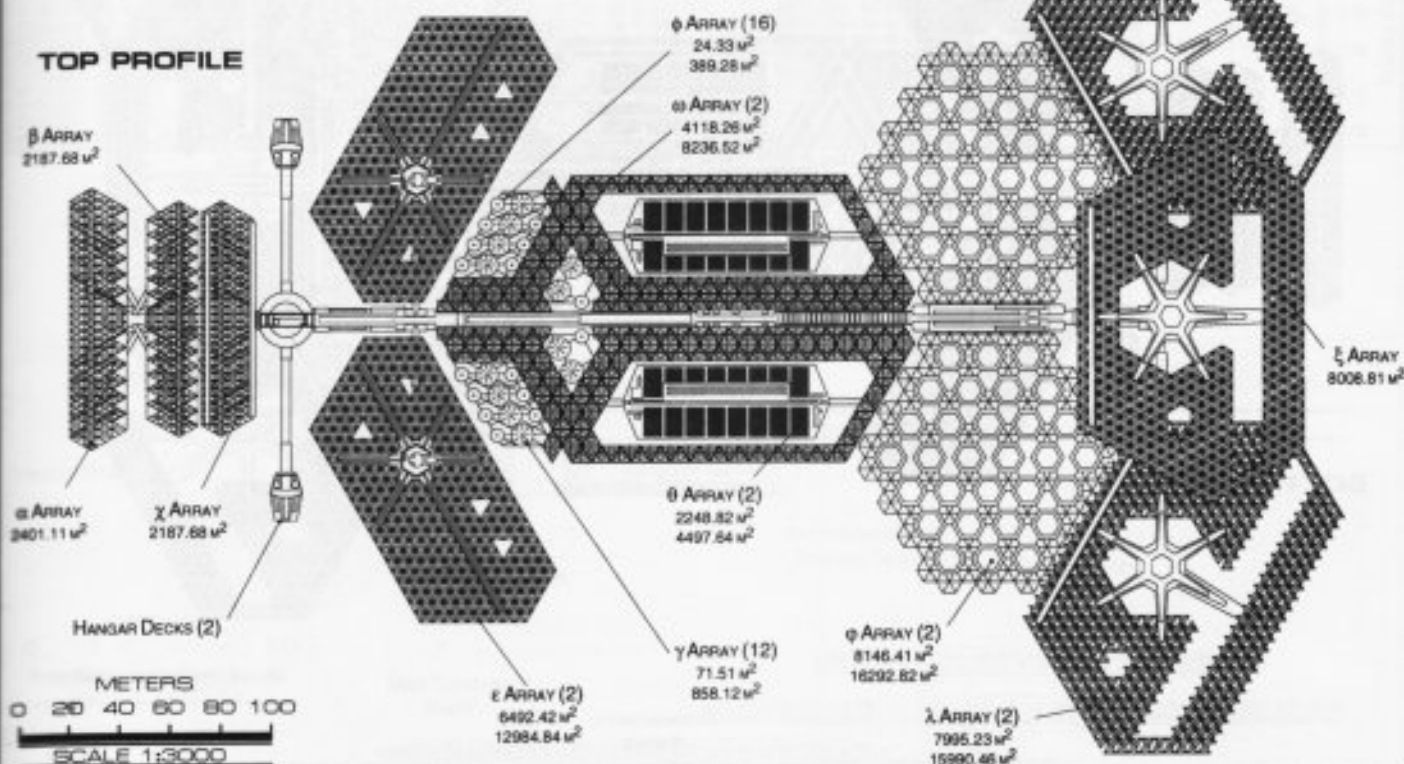

Statistics

Classification: Communication Station

Category: Space Station

Class: Epsilon

Type: Class 3

Model: Type E

Naval Construction Contract: E-1

Number Proposed: 98

Number Constructed: 98

Number in Service: 98

Number Lost: 2

Dimensions:

Overall Dimensions (Meters)

Length: 506.81m

Width: 347.41m

Height: 42.55m

Displacement (Metric Tons)

Light: 342,794mt

Standard: 367,264mt

Full Load: 409,985mt

Performance:

Secondary Reactor Output: 9.5×10^{13} W

Primary Reactor Output: 2.4×10^{15} W

Duration (Years)

Standard: 10 Years

Maximum: 40 Years

Std. Ships Complement: 539

Officers: 6

Crew (Ensign Grade): 31

Troops: 0

Passengers: 15

Emergency condition: +120

Medical Facilities:

Doctors: 2

Nurses: 5

Operating Rooms: 2

Beds: 5

Laboratories: 1

Transporters Total: 3

1 Person: 0

2 Person: 0

6 Person: 2

12 Person: 0

22 Person: 0

Small Cargo: 1

Medium Cargo: 0

Large Cargo: 0

Super Cargo: 0

Brigs: 2

Replicators: 8

TraCTOR Beams: 1

Tow Capacity: 1.88×10^6 mt

Max Range: 9.39×10^6 km

Cargo Specification:

Standard Cargo Units: 40

Cargo Capacity: 2,000mt

Shuttlecraft Specifications:

Docking Ports: 2

Shuttlecraft Bays Total: 2

Small Bay: 2

Medium Bay: 0

Large Bay: 0

Super Bay: 0

Shuttlecraft Standard: 12

Work Bees: 6

Travel Pods: 1

Aquatic Shuttle: 0

Light Shuttle: 1

Standard Shuttle: 4

Heavy Shuttle: 0

Cargo Shuttle: 0

Assault Shuttle: 0

Killer Bees: 0

Fighter: 0

Heavy Fighter: 0

Lifeboats: 10

Turbolift (8 person): 6

Lifeboat (10 person): 3

Lifeboat (20 person): 1

Lifeboat (30 person): 0

Computers: 2

Type: Daystrom Duotronic III:c

Type: Daystrom Duotronic III:c

Shield Rating:

Holdoff Power: 2.88×10^{12} W

Refresh Rate: 8.20×10^{11} W

Breakdown Rate: 9.84×10^{11} W

Shield Dimensions (Meters)

Length: 606.17m

Width: 416.89m

Height: 53.21m

Weapons:

Beam (Phasers) Total: 0

Output: N/A

Range: N/A

Rate of Fire: N/A

Beam (MegaPhasers) Total: 0

Output: N/A

Range: N/A

Rate of Fire: N/A

Torpedoes (Photon) Total: 0

Stock: N/A

Range: N/A

Output: N/A

Rate of Fire: N/A

FEDERATION FACILITY

COMMUNICATION STATION



EPSILON CLASS

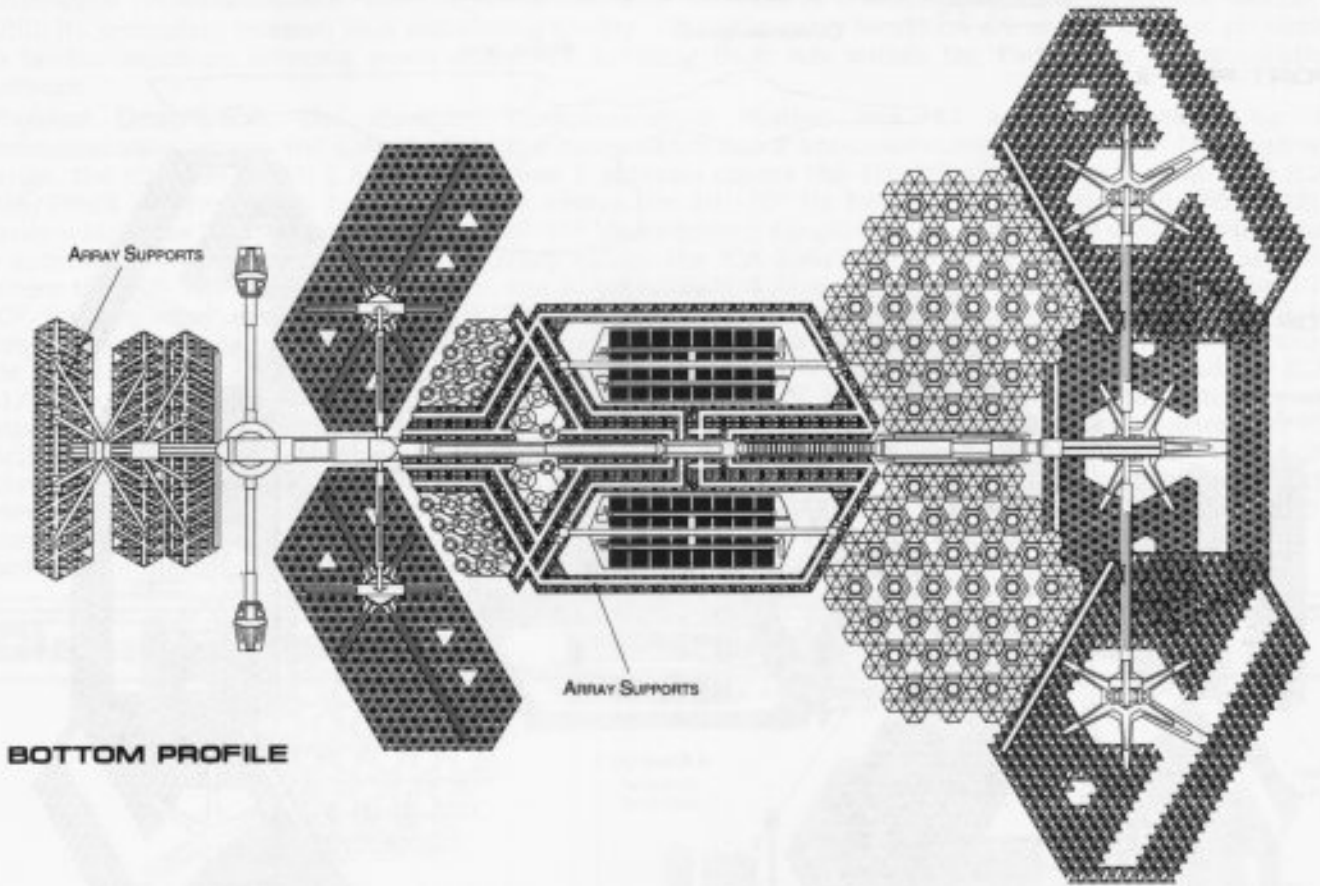

BOTTOM PROFILE

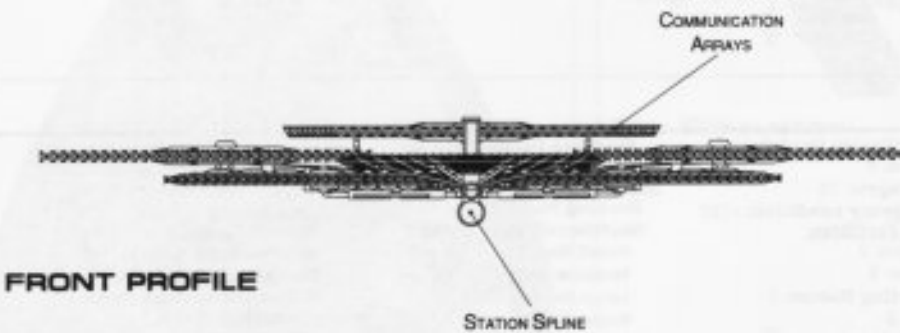

FRONT PROFILE

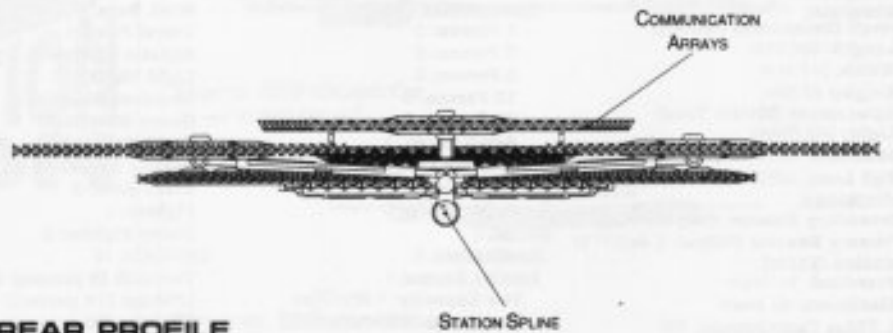

REAR PROFILE

METERS
0 10 20 30 40 50
SCALE 1:2000

FEDERATION FACILITY



COMMUNICATION STATION

Facility Names

THE FOLLOWING FACILITIES OF THE TYPE E CLASS WERE AUTHORIZED BY THE AMENDED ARTICLES OF FEDERATION OF STARDATE 2260.4

EPSILON - 1 E-1*	EPSILON - 26 E-26	EPSILON - 51 E-51	EPSILON - 76 E-76
EPSILON - 2 E-2	EPSILON - 27 E-27	EPSILON - 52 E-52	EPSILON - 77 E-77**
EPSILON - 3 E-3	EPSILON - 28 E-28	EPSILON - 53 E-53	EPSILON - 78 E-78
EPSILON - 4 E-4	EPSILON - 29 E-29	EPSILON - 54 E-54	EPSILON - 79 E-79
EPSILON - 5 E-5	EPSILON - 30 E-30	EPSILON - 55 E-55	EPSILON - 80 E-80
EPSILON - 6 E-6	EPSILON - 31 E-31	EPSILON - 56 E-56	EPSILON - 81 E-81
EPSILON - 7 E-7	EPSILON - 32 E-32	EPSILON - 57 E-57	EPSILON - 82 E-82
EPSILON - 8 E-8	EPSILON - 33 E-33	EPSILON - 58 E-58	EPSILON - 83 E-83
EPSILON - 9 E-9	EPSILON - 34 E-34	EPSILON - 59 E-59	EPSILON - 84 E-84
EPSILON - 10 E-10	EPSILON - 35 E-35	EPSILON - 60 E-60	EPSILON - 85 E-85
EPSILON - 11 E-11	EPSILON - 36 E-36	EPSILON - 61 E-61	EPSILON - 86 E-86
EPSILON - 12 E-12	EPSILON - 37 E-37	EPSILON - 62 E-62	EPSILON - 87 E-87
EPSILON - 13 E-13	EPSILON - 38 E-38	EPSILON - 63 E-63	EPSILON - 88 E-88
EPSILON - 14 E-14	EPSILON - 39 E-39	EPSILON - 64 E-64	EPSILON - 89 E-89
EPSILON - 15 E-15	EPSILON - 40 E-40	EPSILON - 65 E-65	EPSILON - 90 E-90
EPSILON - 16 E-16	EPSILON - 41 E-41	EPSILON - 66 E-66	EPSILON - 91 E-91**
EPSILON - 17 E-17	EPSILON - 42 E-42	EPSILON - 67 E-67	EPSILON - 92 E-92
EPSILON - 18 E-18	EPSILON - 43 E-43	EPSILON - 68 E-68	EPSILON - 93 E-93
EPSILON - 19 E-19	EPSILON - 44 E-44	EPSILON - 69 E-69	EPSILON - 94 E-94
EPSILON - 20 E-20	EPSILON - 45 E-45	EPSILON - 70 E-70	EPSILON - 95 E-95
EPSILON - 21 E-21	EPSILON - 46 E-46	EPSILON - 71 E-71	EPSILON - 96 E-96
EPSILON - 22 E-22	EPSILON - 47 E-47	EPSILON - 72 E-72	EPSILON - 97 E-97
EPSILON - 23 E-23	EPSILON - 48 E-48	EPSILON - 73 E-73	EPSILON - 98 E-98
EPSILON - 24 E-24	EPSILON - 49 E-49	EPSILON - 74 E-74	
EPSILON - 25 E-25	EPSILON - 50 E-50**	EPSILON - 75 E-75	

*CLASS FACILITY. **LOST IN THE LINE OF DUTY. ***PROPOSED. ALL NAMES PRECEDED WITH "UFP"

Tractor Beam Specifications

Primary Tractor Beam Load Calculator

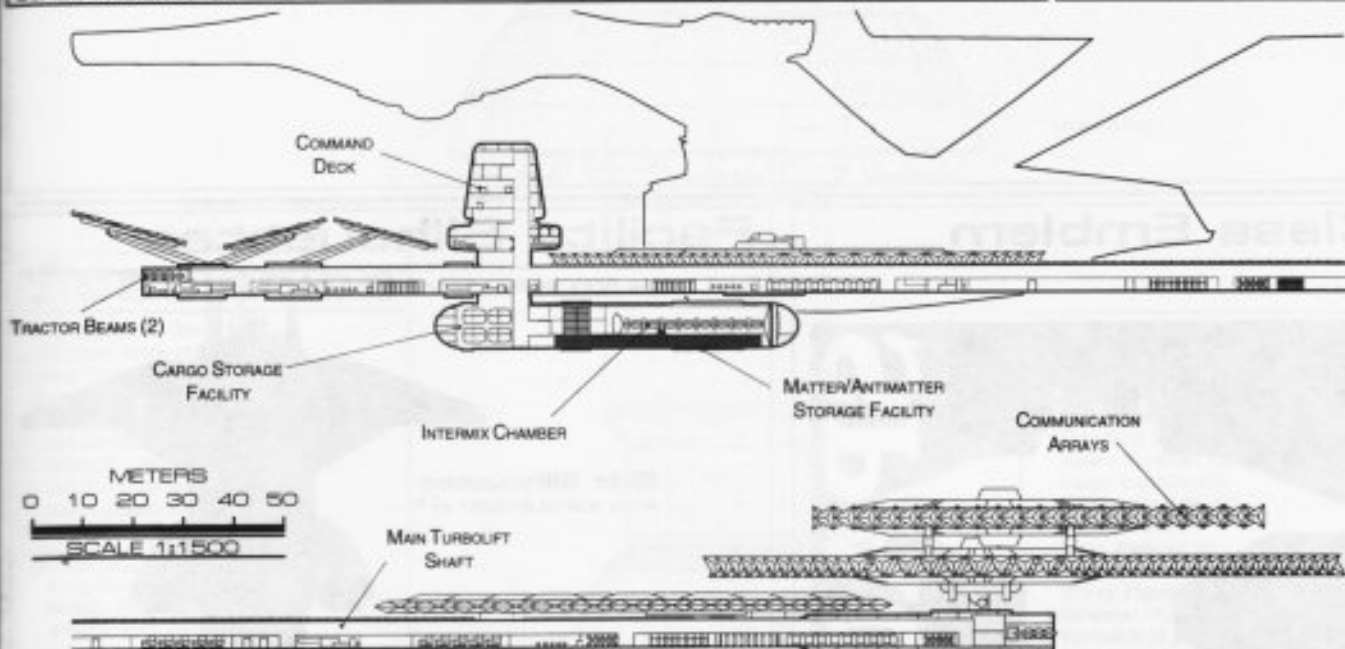
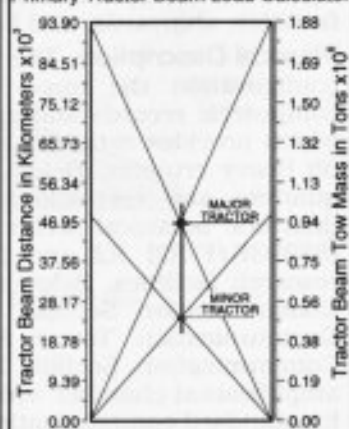

CROSS SECTION ENLARGED FOR CLARITY

RELATIVE ANTENNA POWER GAIN VS FREQUENCY

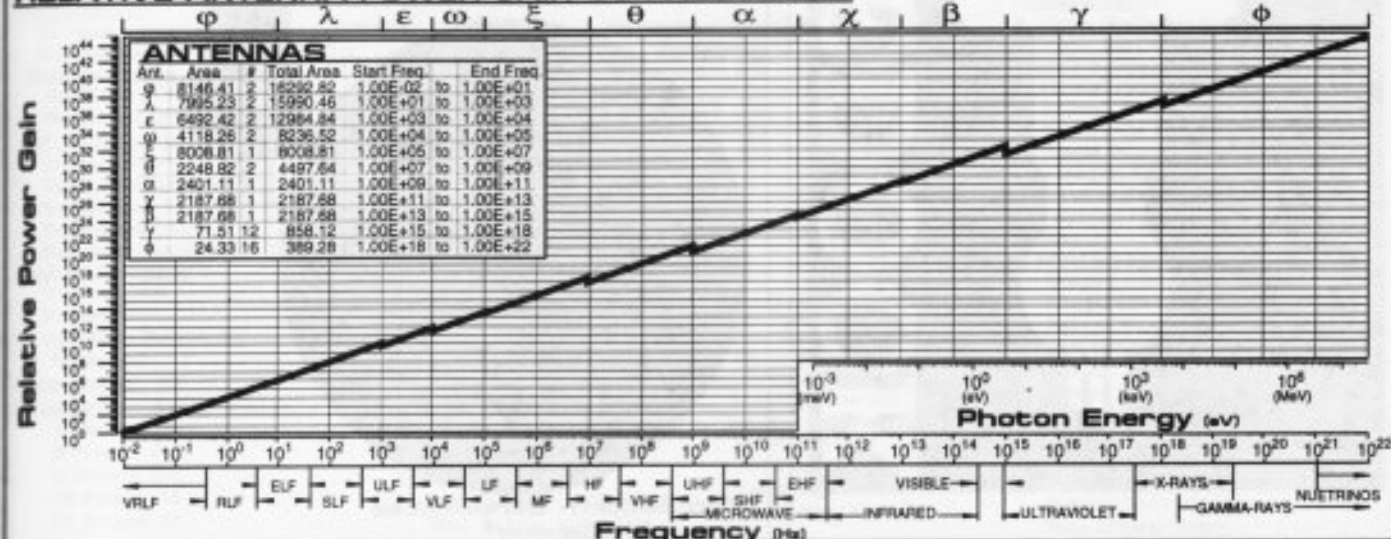

SPACEDOCK



JOURNAL CLASS

General Information

Specific Role: Spacedocks play a multifaceted role in Federation culture. They are cities in space, research facilities, shipyards, and Federation administration hubs.

Physical Description: The Spacedock is made up of 9 vertically stacked modular sections. In the standard configuration the upper section is the (SS128K/F-A1) A1 Administration Section which provides computers, records and administration facilities. Below this is the (SS1025K/F-D1) D1 DryDock Section which provides extensive starship and shuttlecraft maintenance facilities. The DryDock is able to shelter 38 heavy cruisers. Below the DryDock is the (SS205K/F-H2) H2 Habitat Section which contains living quarters and recreational facilities. The (SS432K/F-H1) H1 Habitat Section, which contains living quarters, botanical section and recreational facilities, is directly below the H2 section. Below this is the (SS293K/F-R2) R2 and (SS205K/F-R1) R1 Research Sections containing extensive laboratories and research facilities. Below the research sections are the communication sections: the (SS258K/F-C1) C1 Communication Section, and (SS102K/F-C2) C2 Communication Tower Section, (SS102K/F-C3) C3 Communication Tower Section or a (SS98K/F-C4) C4 Communication Tower Section. The C1 Communication Section houses communication stations and an extensive communication resonant amplification chamber which is used for long range communications. The C2, C3 and C4 towers are used for standard communications.

Class Emblem

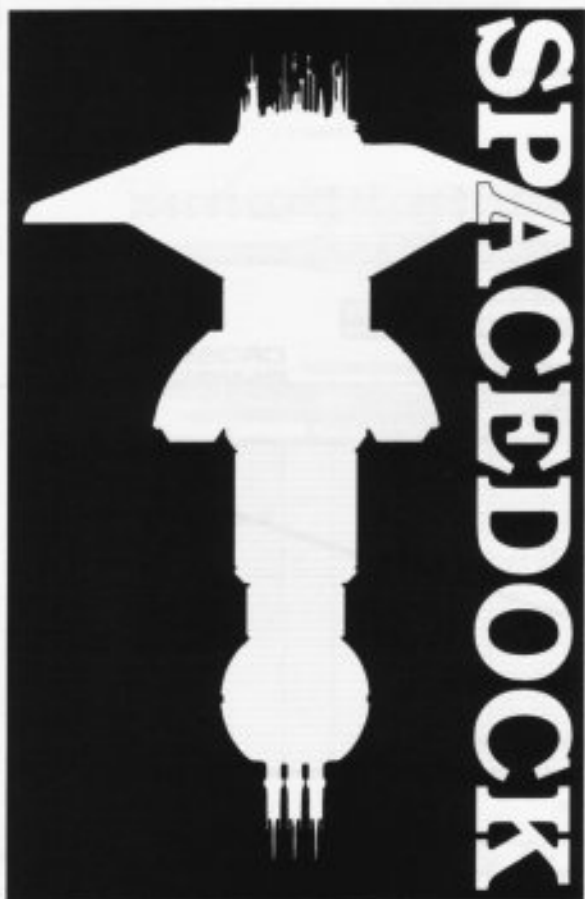

Facility Silhouettes

Total Target Area 25,523,422.42 m²

Side Silhouette
Area 8,910,213.97 m²

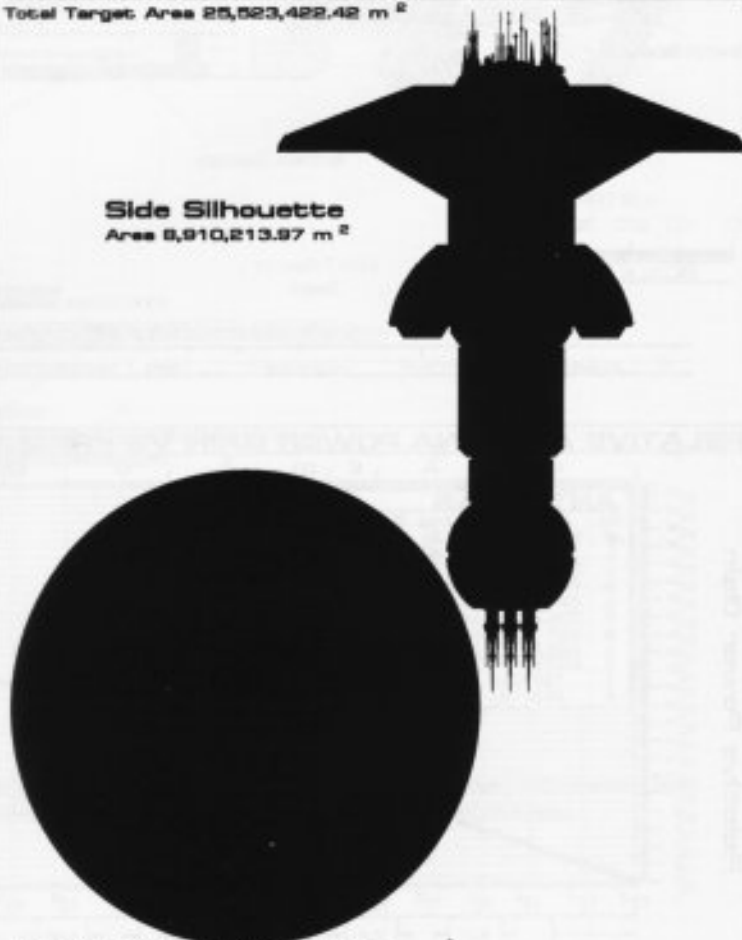

Top/Bottom Silhouettes
Area 16,613,208.45 m²

FEDERATION FACILITY



METERS
0 300 600 900
SCALE 1:33000

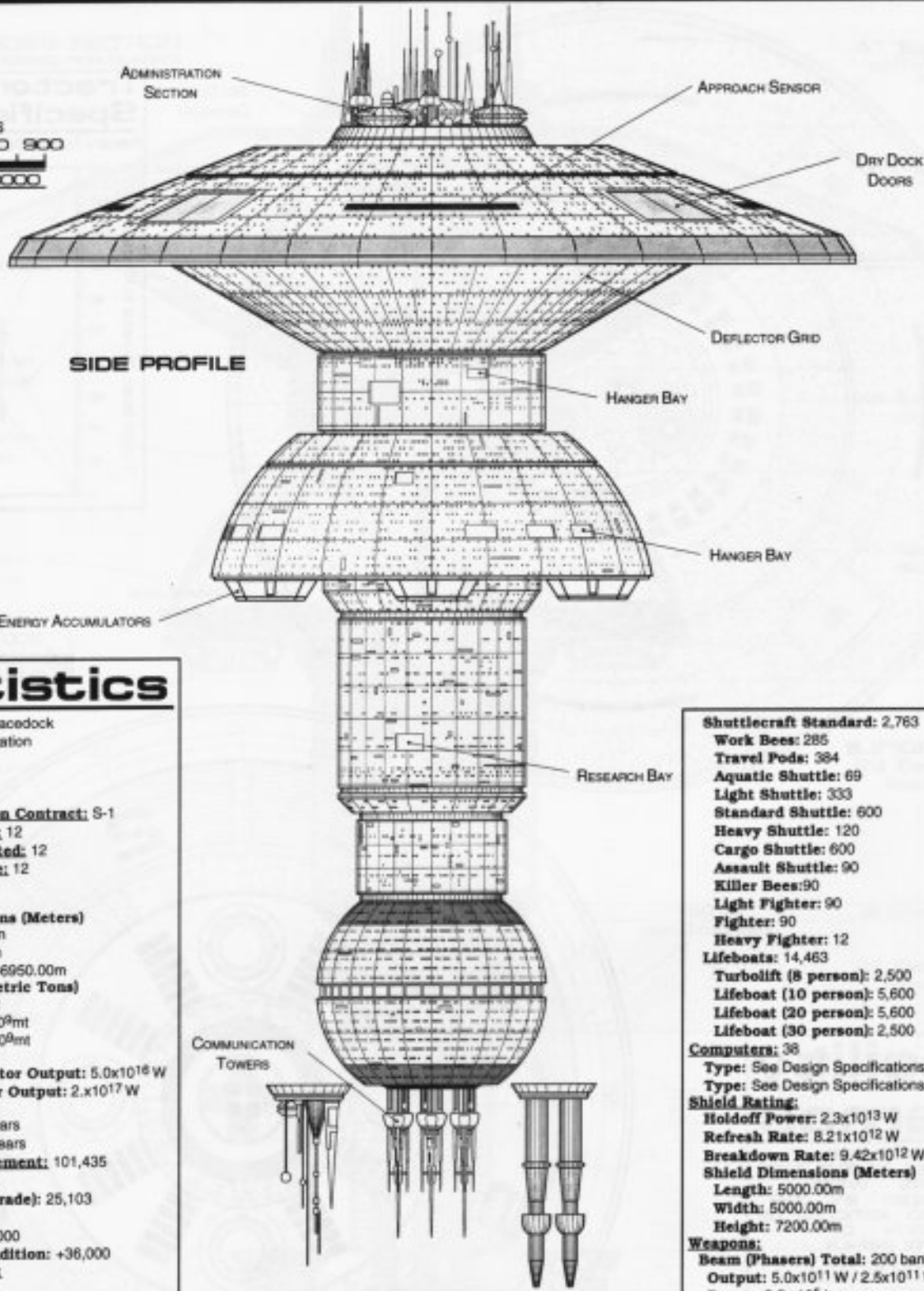

Statistics

Classification: Spacedock
Category: Space Station
Class: Journal
Type: Class 3
Model: Type S
Naval Construction Contract: S-1
Number Proposed: 12
Number Constructed: 12
Number in Service: 12
Number Lost: 0
Dimensions:
Overall Dimensions (Meters)
 Length: 4600.00m
 Width: 4600.00m
 Height: 6900.00-6950.00m
Displacement (Metric Tons)
 Light: 4.8×10^9 mt
 Standard: 5.2×10^9 mt
 Full Load: 5.8×10^9 mt
Performance:
Secondary Reactor Output: 5.0×10^{16} W
Primary Reactor Output: $2. \times 10^{17}$ W
Duration (Years)
 Standard: 30 Years
 Maximum: 70 Years
Std. Ships Complement: 101,435
 Officers: 51,432
 Crew (Ensign Grade): 25,103
 Troops: 900
 Passengers: 24,000
 Emergency condition: +36,000
Medical Facilities:
 Doctors: 1800
 Nurses: 9450
 Operating Rooms: 900
 Beds: 9450
Laboratories: 900
Transporters Total: 917
 1 Person: 120
 2 Person: 210
 6 Person: 500
 12 Person: 15
 22 Person: 24

Small Cargo: 24
Medium Cargo: 18
Large Cargo: 3
Super Cargo: 2
Super Cargo2: 1 (Special)
Brigs: 1000
Replicators: 4025
Tractor Beams: 30
 Tow Capacity: 1.23×10^{17} mt
 Max Range: 9.39×10^6 km

Cargo Specification:
 Standard Cargo Units: 119,582
 Cargo Capacity: 5.8×10^9 mt
Shuttlecraft Specifications:
 Docking Ports: 600
 Shuttlecraft Bays Total: 180
 Small Bay: 100
 Medium Bay: 50
 Large Bay: 20
 Super Bay: 10

Shuttlecraft Standard: 2,763
Work Bees: 285
Travel Pods: 384
Aquatic Shuttle: 69
Light Shuttle: 333
Standard Shuttle: 600
Heavy Shuttle: 120
Cargo Shuttle: 600
Assault Shuttle: 90
Killer Bees: 90
Light Fighter: 90
Fighter: 90
Heavy Fighter: 12
Lifeboats: 14,463
Turbolift (8 person): 2,500
Lifeboat (10 person): 5,600
Lifeboat (20 person): 5,600
Lifeboat (30 person): 2,500
Computers: 38
Type: See Design Specifications
Type: See Design Specifications
Shield Rating:
Holdoff Power: 2.3×10^{13} W
Refresh Rate: 8.21×10^{12} W
Breakdown Rate: 9.42×10^{12} W
Shield Dimensions (Meters)
 Length: 5000.00m
 Width: 5000.00m
 Height: 7200.00m
Weapons:
Beam (Phasers) Total: 200 banks 2 each
Output: 5.0×10^{11} W / 2.5×10^{11} W
Range: 2.5×10^5 km
Rate of Fire: 30 ppm / Cont.
Beam (MegaPhasers) Total: 40
Output: 2.6×10^{12} W / 1.3×10^{12} W
Range: 1.0×10^6 km
Rate of Fire: 15 ppm / Cont.
Torpedoes (Photon) Total: 20 Bay 2 each
Stock: 4000
Range: 2.0×10^5 km
Output: 10-50 Megatons
Rate of Fire: 10 spm

SPACEDOCK



JOURNAL CLASS

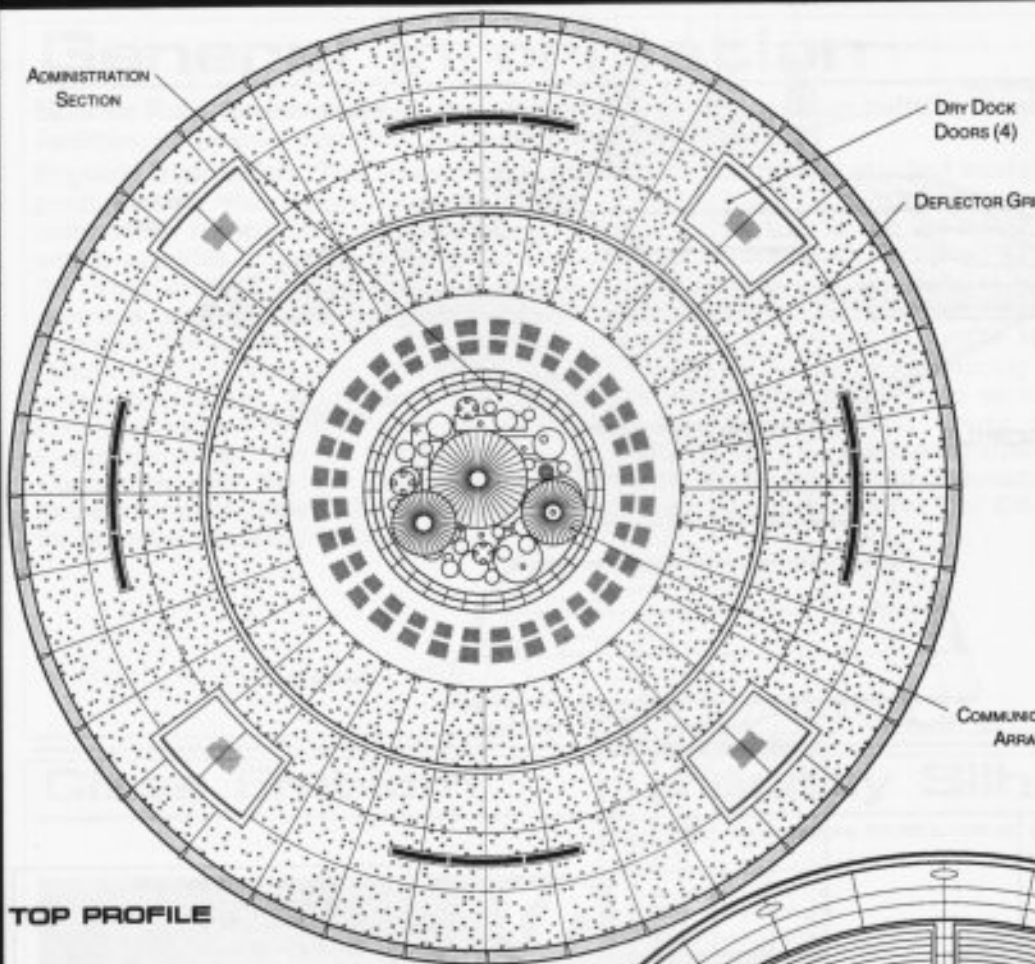

TOP PROFILE

Tractor Beam Specifications

Primary Tractor Beam Load Calculator

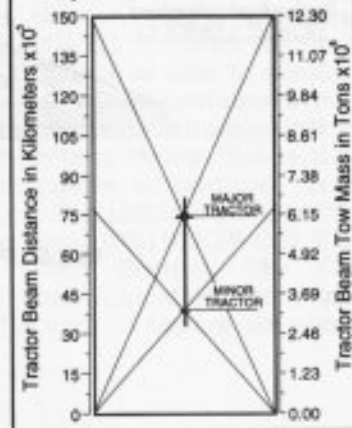

Facility Names

THE FOLLOWING FACILITIES OF THE TYPE D CLASS WERE AUTHORIZED BY THE AMENDED ARTICLES OF FEDERATION OF STARDATE 2264.9

- ALPHA CENTARI PORT *S-6
- BARNARD FLAERE PORT *S-3
- MAGELLANIC PORT *S-11
- JOURNAL PORT *S-1*
- PIXAR PORT *S-12
- RIGEL PORT *S-8
- STARBASE 13 *S-4
- STARBASE 34 *S-5
- STARBASE 4 *S-2
- STARBASE 52 *S-7
- STARBASE 54 *S-9
- STARBASE 79 *S-10

*CLASS FACILITY. *LOST IN THE LINE OF DUTY. *PROPOSED. ALL NAMES PRECEDED WITH *UPP*

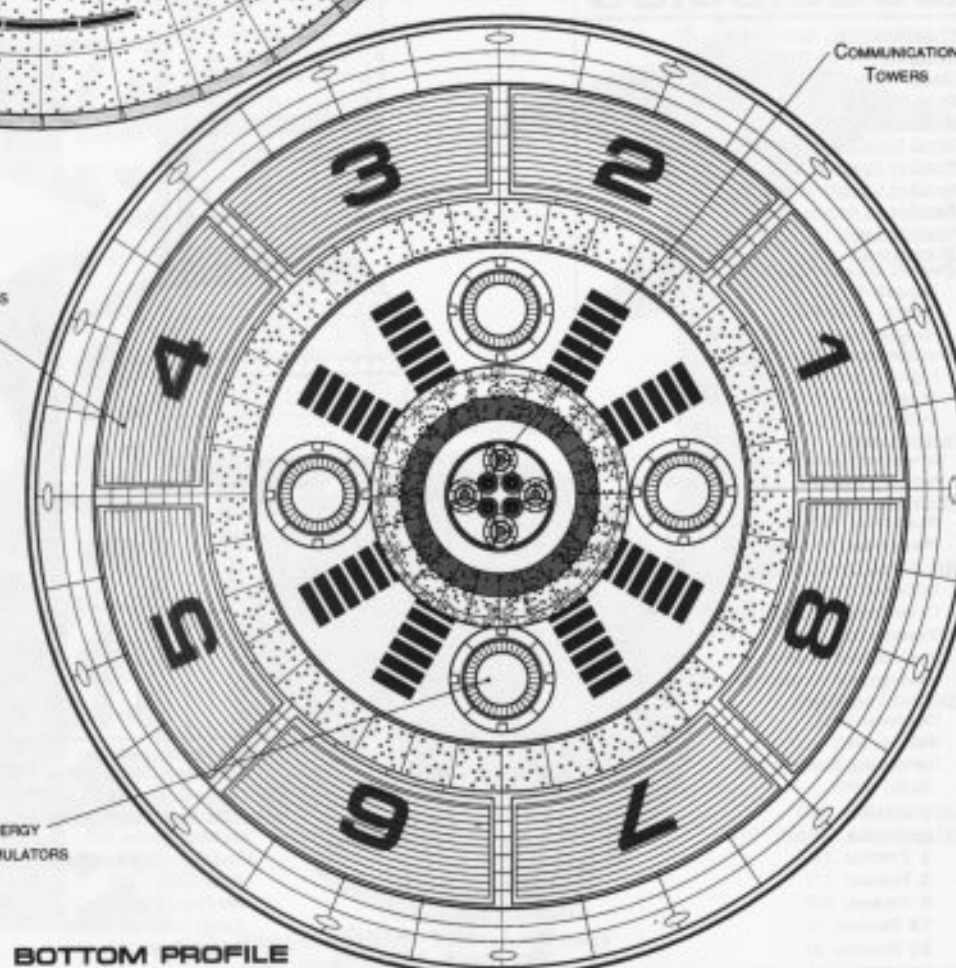

BOTTOM PROFILE

FEDERATION FACILITY



SPACEDOCK

JOURNAL CLASS

CROSS SECTION
ENLARGED FOR CLARITY

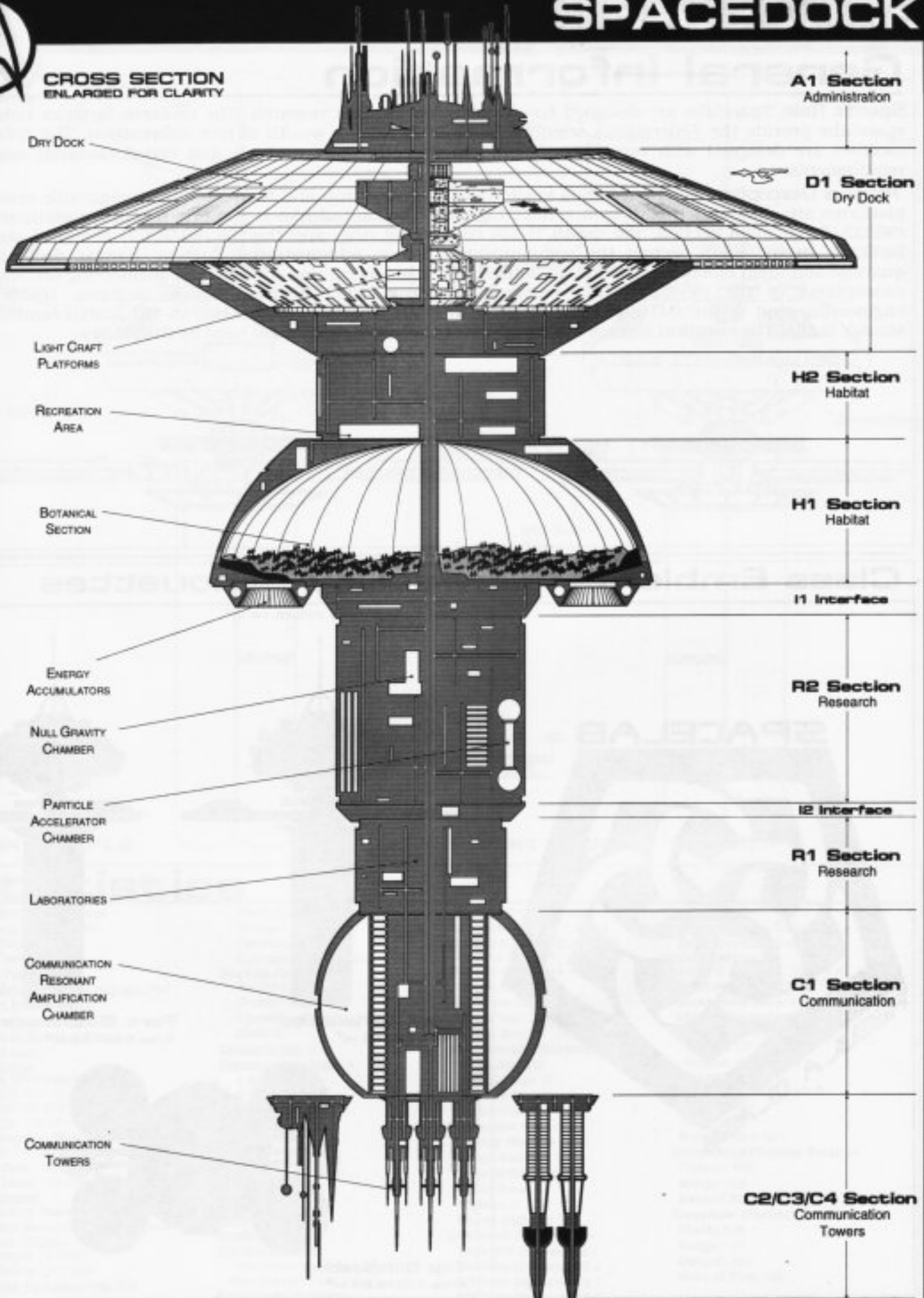

FEDERATION FACILITY

SPACELAB



REGULA CLASS

General Information

Specific Role: Spacelabs are designed for extensive on location research. The research facilities onboard spacelabs provide the Federation's scientific community with a wealth of new information. The onboard facilities are designed with versatility in mind in order to meet multiple and varied research mission requirements.

Physical Description: The Spacelab is made up of a central hub and four exterior, configurable research platforms attached underneath by a connecting ring. The central hub is comprised of three sections: the (SS325/R-S2) main section, the (SS48/R-E9) connecting ring, and the (SS298/R-C5) chemical storage facilities. In the main section the communication array, administration section, hangar deck, living quarters and main laboratory bay are all housed. The connecting ring contains the engineering section and connections to the (SS123/X-XX3) research platforms and chemical storage facilities. Inside the engineering ring is the (MT30/12-2A) toroidal intermix chamber and (AM8/48-4K) matter/antimatter storage tanks. The chemical storage facility houses the chemicals that are used by the facility.

Class Emblem



Facility Silhouettes

Total Target Area 22652.16 m²

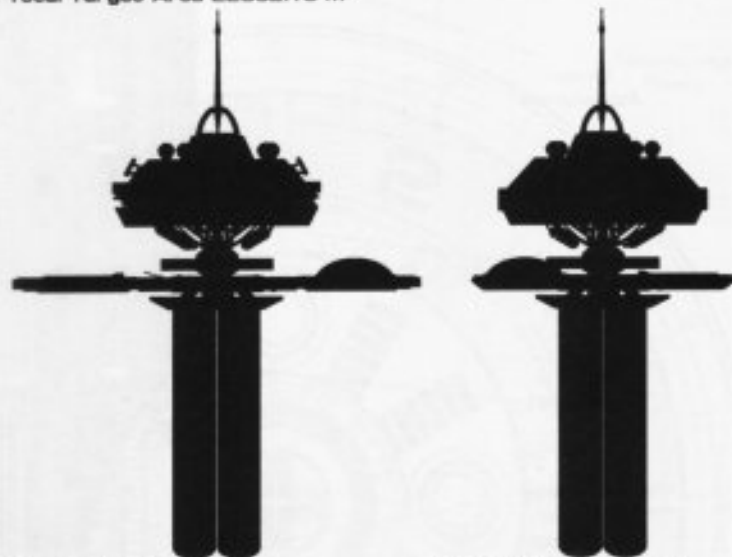

Front Silhouette
Area 6292.64 m²

Port Silhouette
Area 5998.68 m²

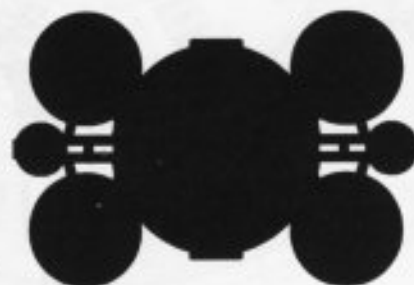

Top Silhouette
Area 10372.84 m²

FEDERATION FACILITY



SPACELAB

REGULA CLASS

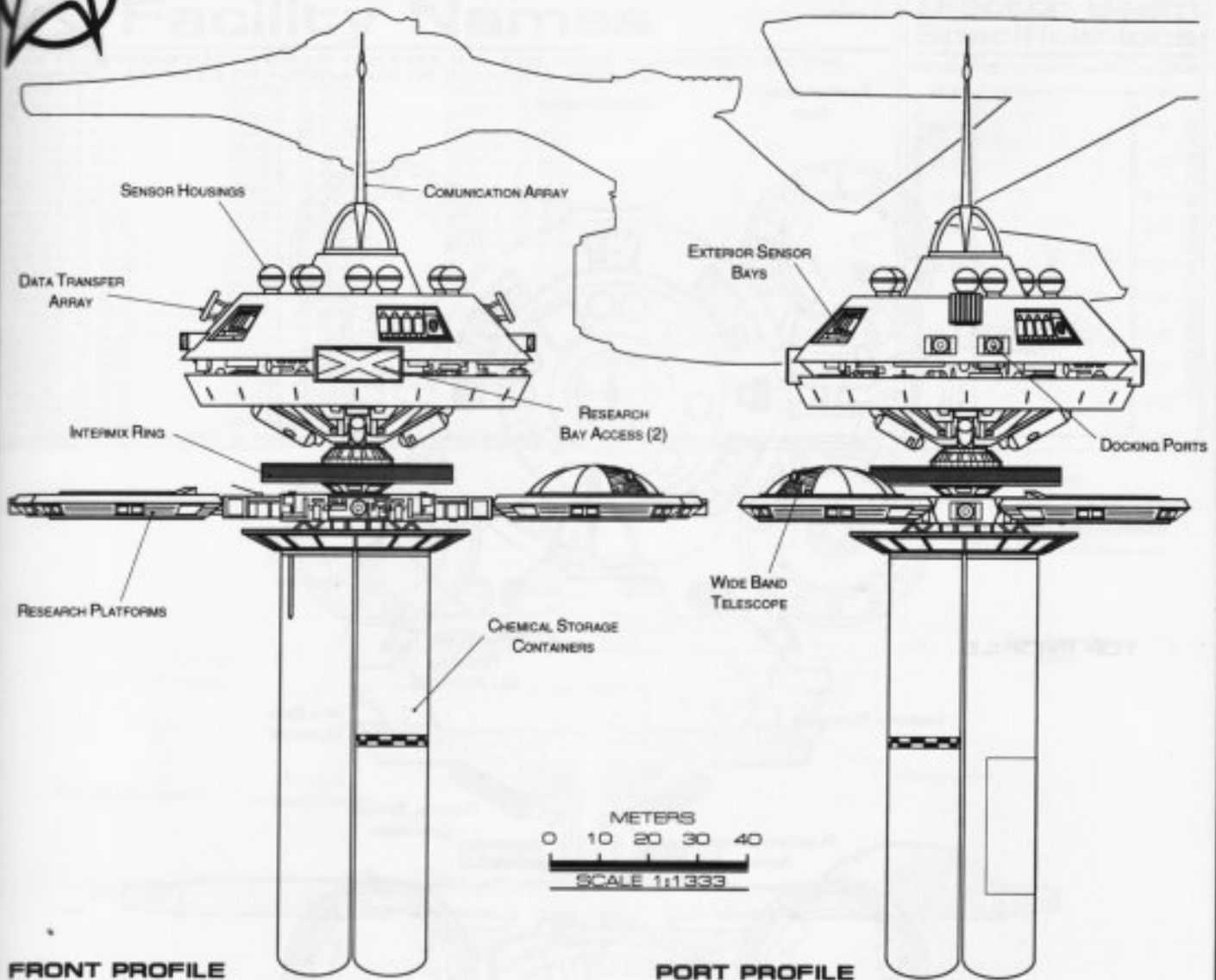

Statistics

Classification: Spacelab
Category: Space Station
Class: Regula
Type: Class 3
Model: Type R
Naval Construction Contract: R-1
Number Proposed: 62
Number Constructed: 62
Number in Service: 61
Number Lost: 1
Dimensions:
Overall Dimensions (Meters)
 Length: 92.41m
 Width: 143.47m
 Height: 193.12m
Displacement (Metric Tons)
 Light: 94,797mt
 Standard: 101,564mt
 Full Load: 113,378mt
Performance:
Secondary Reactor Output: 2.4x10¹³ W
Primary Reactor Output: 1.0x10¹⁵ W
Duration (Years)
 Standard: 10 Years
 Maximum: 40 Years
Std. Ships Complement: 639
 Officers: 12

Crew (Ensign Grade): 61
Troops: 0
Passengers: 15
Emergency condition: +120
Medical Facilities:
 Doctors: 3
 Nurses: 8
 Operating Rooms: 2
 Beds: 8
Laboratories: 8
Transporters Total: 4
 1 Person: 0
 2 Person: 0
 6 Person: 2
 12 Person: 0
 22 Person: 0
 Small Cargo: 2
 Medium Cargo: 0
 Large Cargo: 0
 Super Cargo: 0
Brigs: 2
Replicators: 12
Tractor Beams: 1
Tow Capacity: 1.01x10⁶mt
Max Range: 7.64x10⁵km
Cargo Specification:

Standard Cargo Units: 70
Cargo Capacity: 3,500mt
Shuttlecraft Specifications:
Docking Ports: 6
Shuttlecraft Bays Total: 1
 Small Bay: 1
 Medium Bay: 0
 Large Bay: 0
 Super Bay: 0
Shuttlecraft Standard: 3
 Work Bees: 0
 Travel Pods: 0
 Aquatic Shuttle: 0
 Light Shuttle: 1
 Standard Shuttle: 1
 Survey Shuttle: 1
 Cargo Shuttle: 0
 Assault Shuttle: 0
 Killer Bees: 0
 Fighter: 0
 Heavy Fighter: 0
Lifeboats: 7
 Turbolift (8 person): 4
 Lifeboat (10 person): 2
 Lifeboat (20 person): 1
 Lifeboat (30 person): 0

Computers: 2
Type: Daystrom Duotronic III:a
Type: Daystrom Duotronic II:j
Shield Rating:
Holdoff Power: 2.15x10¹² W
Refresh Rate: 6.12x10¹¹ W
Breakdown Rate: 7.35x10¹¹ W
Shield Dimensions (Meters)
 Length: 110.89m
 Width: 172.16m
 Height: 231.74m
Weapons:
Beam (Phasers) Total: 0
 Output: N/A
 Range: N/A
 Rate of Fire: N/A
Beam (MegaPhasers) Total: 0
 Output: N/A
 Range: N/A
 Rate of Fire: N/A
Torpedoes (Photons) Total: 0
 Stock: N/A
 Range: N/A
 Output: N/A
 Rate of Fire: N/A

FEDERATION FACILITY

SPACELAB



REGULA CLASS

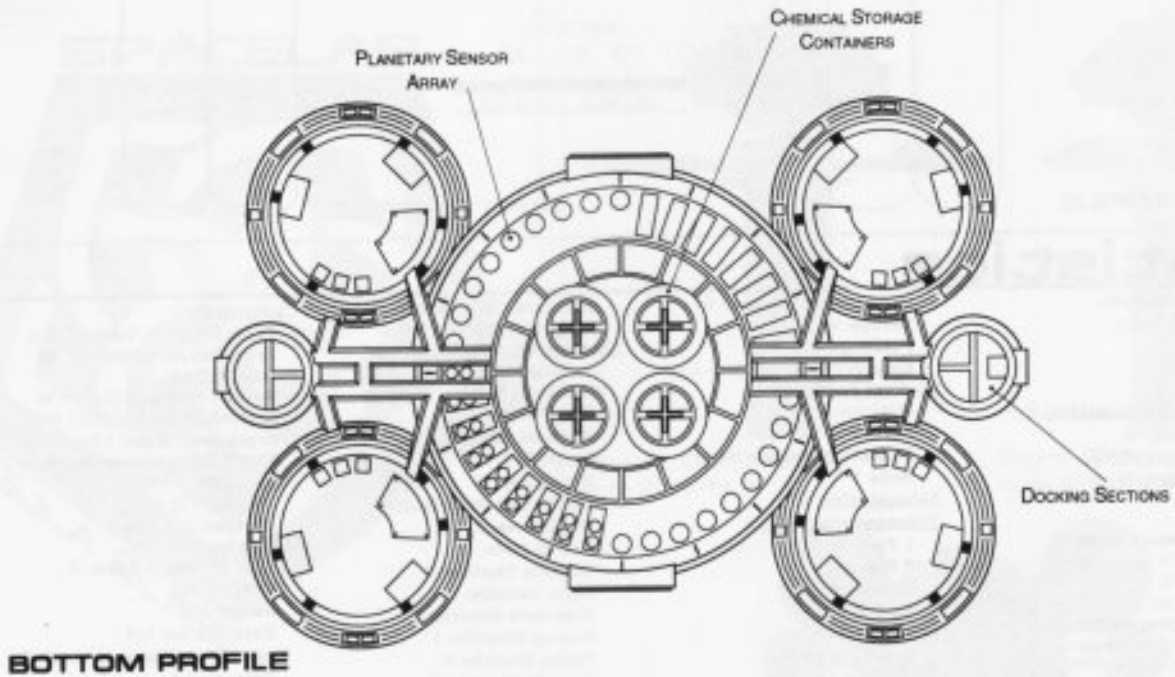
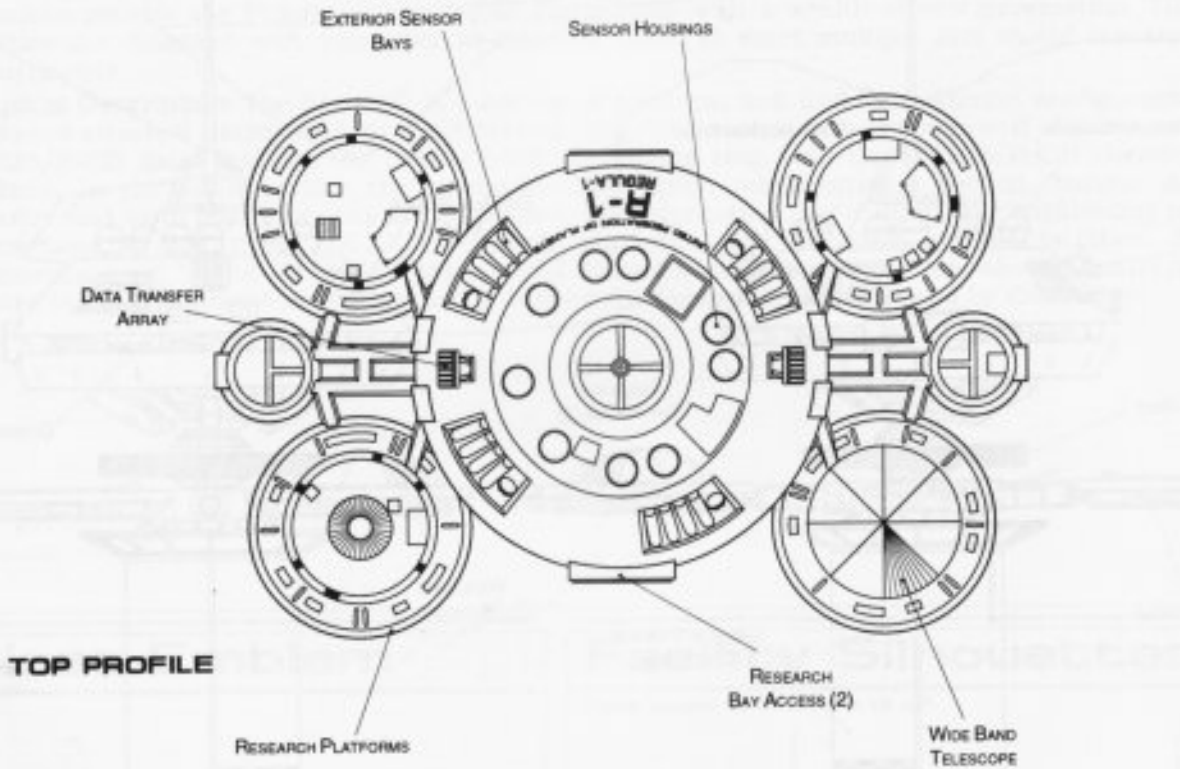

FEDERATION FACILITY





Facility Names

THE FOLLOWING FACILITIES OF THE TYPE R CLASS WERE AUTHORIZED BY THE AMENDED ARTICLES OF FEDERATION OF STARDATE 2272.12

REGULA - 1 #R-1*	REGULA - 26 #R-26	REGULA - 51 #R-51
REGULA - 2 #R-2	REGULA - 27 #R-27	REGULA - 52 #R-52
REGULA - 3 #R-3	REGULA - 28 #R-28	REGULA - 53 #R-53
REGULA - 4 #R-4	REGULA - 29 #R-29	REGULA - 54 #R-54
REGULA - 5 #R-5	REGULA - 30 #R-30	REGULA - 55 #R-55
REGULA - 6 #R-6	REGULA - 31 #R-31	REGULA - 56 #R-56
REGULA - 7 #R-7	REGULA - 32 #R-32	REGULA - 57 #R-57
REGULA - 8 #R-8	REGULA - 33 #R-33	REGULA - 58 #R-58
REGULA - 9 #R-9	REGULA - 34 #R-34**	REGULA - 59 #R-59
REGULA - 10 #R-10	REGULA - 35 #R-35	REGULA - 60 #R-60
REGULA - 11 #R-11	REGULA - 36 #R-36	REGULA - 61 #R-61
REGULA - 12 #R-12	REGULA - 37 #R-37	REGULA - 62 #R-62
REGULA - 13 #R-13	REGULA - 38 #R-38	
REGULA - 14 #R-14	REGULA - 39 #R-39	
REGULA - 15 #R-15	REGULA - 40 #R-40	
REGULA - 16 #R-16	REGULA - 41 #R-41	
REGULA - 17 #R-17	REGULA - 42 #R-42	
REGULA - 18 #R-18	REGULA - 43 #R-43	
REGULA - 19 #R-19	REGULA - 44 #R-44	
REGULA - 20 #R-20	REGULA - 45 #R-45	
REGULA - 21 #R-21	REGULA - 46 #R-46	
REGULA - 22 #R-22	REGULA - 47 #R-47	
REGULA - 23 #R-23	REGULA - 48 #R-48	
REGULA - 24 #R-24	REGULA - 49 #R-49	
REGULA - 25 #R-25	REGULA - 50 #R-50	

*CLASS FACILITY. **LOST IN THE LINE OF DUTY. ***PROPOSED. ALL NAMES PRECEDED WITH "UPP"

Tractor Beam Specifications

Primary Tractor Beam Load Calculator

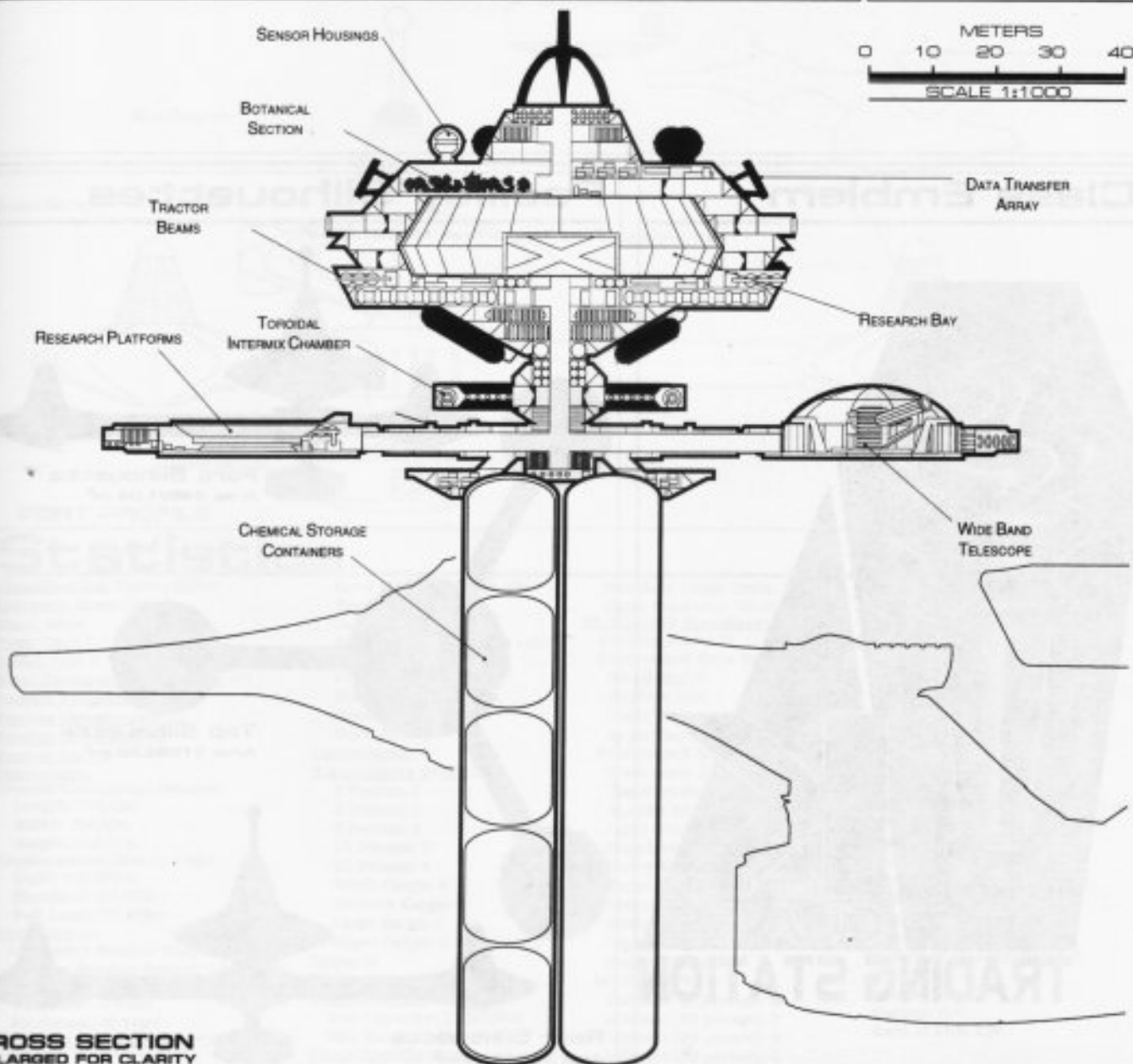
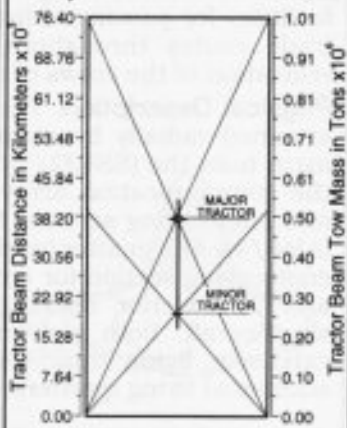

CROSS SECTION ENLARGED FOR CLARITY

TRADING STATION



KEPLER CLASS

General Information

Specific Role: Trading Stations are designed for extensive cargo handling and to provide recreational facilities for passing ships. Cargo handling and transshipping facilities at remote locations enhance vital trade routes throughout the Federation. Comprehensive recreational facilities are provided for the relaxation of the crews of various species during cargo transfers and lay overs.

Physical Description: The Trading Post consists of a central hub and three exterior habitats which are attached radially by connecting arms. The central hub is made up of three sections: the (SS728/T-S2) main hub, the (SS432/T-S9) connecting hub, and the (SS412/T-S5) hangar deck. The main hub contains the communication array, administration and botanical sections, living quarters, recreational facilities, and engineering section. Situated inside the engineering section is an (M30/8-2E) intermix chamber and (AM8/48-4K) matter/antimatter storage tanks. The tanks are located along the outer hull of the engineering section for emergency jettisoning. The connecting hub contains the main cargo storage facility and 27 exterior docking ports. The hangar deck is designed to accommodate a large number of shuttlecraft, both conventional and non-conventional. Each (DU/587-555C) connecting arm contains extensive living quarters. Each (SS538/T-A3) exterior section (Alpha, Beta and Gamma) contains additional living quarters, recreational facilities, and cargo storage and handling facilities.

Class Emblem



Facility Silhouettes

Total Target Area 183191.98 m²



Port Silhouette
Area 44661.04 m²

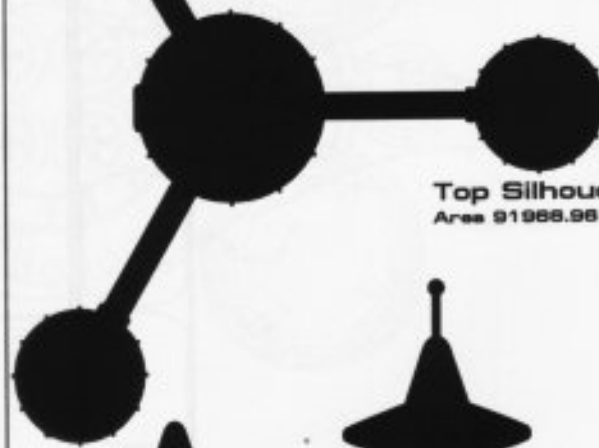

Top Silhouette
Area 91966.96 m²



Rear Silhouette
Area 46543.98 m²

FEDERATION FACILITY



TRADING STATION

KEPLER CLASS

METERS
0 20 40 60 80 100
SCALE 1:4000

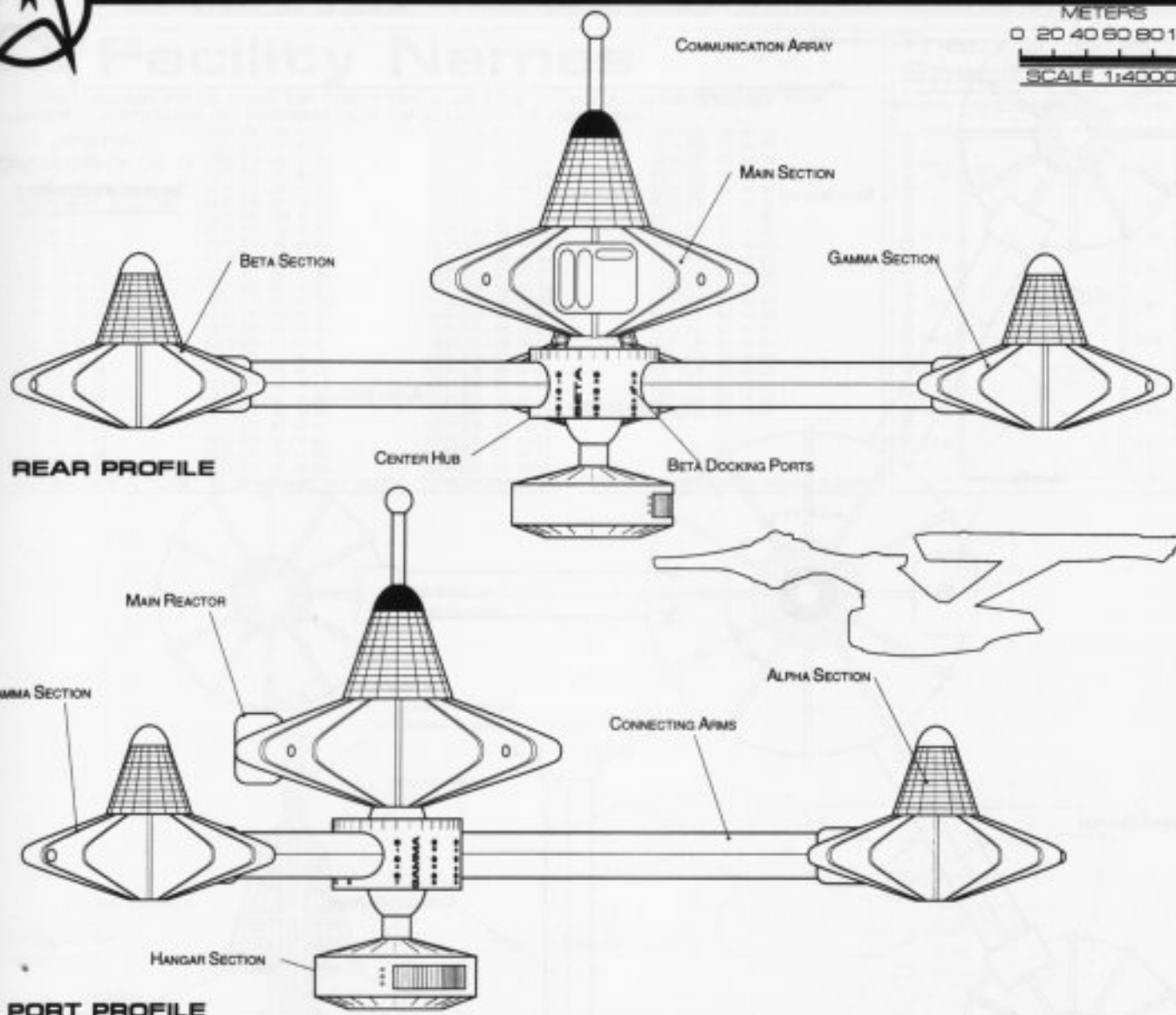

Statistics

Classification: Trading Station

Category: Space Station

Class: Kepler

Type: Class 3

Model: Type K

Naval Construction Contract: K-1

Number Proposed: 96

Number Constructed: 96

Number in Service: 96

Number Lost: 0

Dimensions:

Overall Dimensions (Meters)

Length: 634.43m

Width: 704.80m

Height: 318.31m

Displacement (Metric Tons)

Light: 645,829mt

Standard: 691,932mt

Full Load: 772,418mt

Performance:

Secondary Reactor Output: 7.5×10^{13} W

Primary Reactor Output: 1.2×10^{15} W

Duration (Years)

Standard: 10 Years

Maximum: 40 Years

Std. Ships Complement: 1130

Officers: 192

Crew (Ensign Grade): 938

Troops: 0

Passengers: 400

Emergency condition: +400

Medical Facilities:

Doctors: 8

Nurses: 42

Operating Rooms: 8

Beds: 42

Laboratories: 8

Transporters Total: 22

1 Person: 0

2 Person: 2

6 Person: 8

12 Person: 0

22 Person: 4

Small Cargo: 4

Medium Cargo: 4

Large Cargo: 0

Super Cargo: 0

Brigs: 32

Replicators: 21

TraCTOR Beams: 2

Tow Capacity: 3.65×10^6 mt

Max Range: 1.45×10^6 km

Cargo Specification:

Standard Cargo Units: 3245

Cargo Capacity: 162,250mt

Shuttlecraft Specifications:

Docking Ports: 27

Shuttlecraft Bays Total: 1

Small Bay: 0

Medium Bay: 1

Large Bay: 0

Super Bay: 0

Shuttlecraft Standard: 30

Work Bees: 2

Travel Pods: 2

Aquatic Shuttle: 0

Light Shuttle: 4

Standard Shuttle: 12

Heavy Shuttle: 2

Cargo Shuttle: 8

Assault Shuttle: 0

Killer Bees: 0

Fighter: 0

Heavy Fighter: 0

Lifeboats: 76

Turbolift (8 person): 52

Lifeboat (10 person): 8

Lifeboat (20 person): 8

Lifeboat (30 person): 8

Computers: 2

Type: Daystrom Duotronic III:z

Type: Daystrom Duotronic II:h

Shield Rating:

Holdoff Power: 5.42×10^{12} W

Refresh Rate: 9.35×10^{11} W

Breakdown Rate: 1.12×10^{11} W

Shield Dimensions (Meters)

Length: 761.32m

Width: 845.76m

Height: 381.97m

Weapons:

Beam (Phasers) Total: 6 banks 2 each

Output: 5.0×10^{11} W / 2.5×10^{11} W

Range: 2.5×10^5 km

Rate of Fire: 30 ppm / Cont.

Beam (MegaPhasers) Total: 0

Output: N/A

Range: N/A

Rate of Fire: N/A

Torpedoes (Photon) Total: 0

Stock: N/A

Range: N/A

Output: N/A

Rate of Fire: N/A

FEDERATION FACILITY

TRADING STATION



METERS
0 20 40 60 80 100
SCALE 1:4000

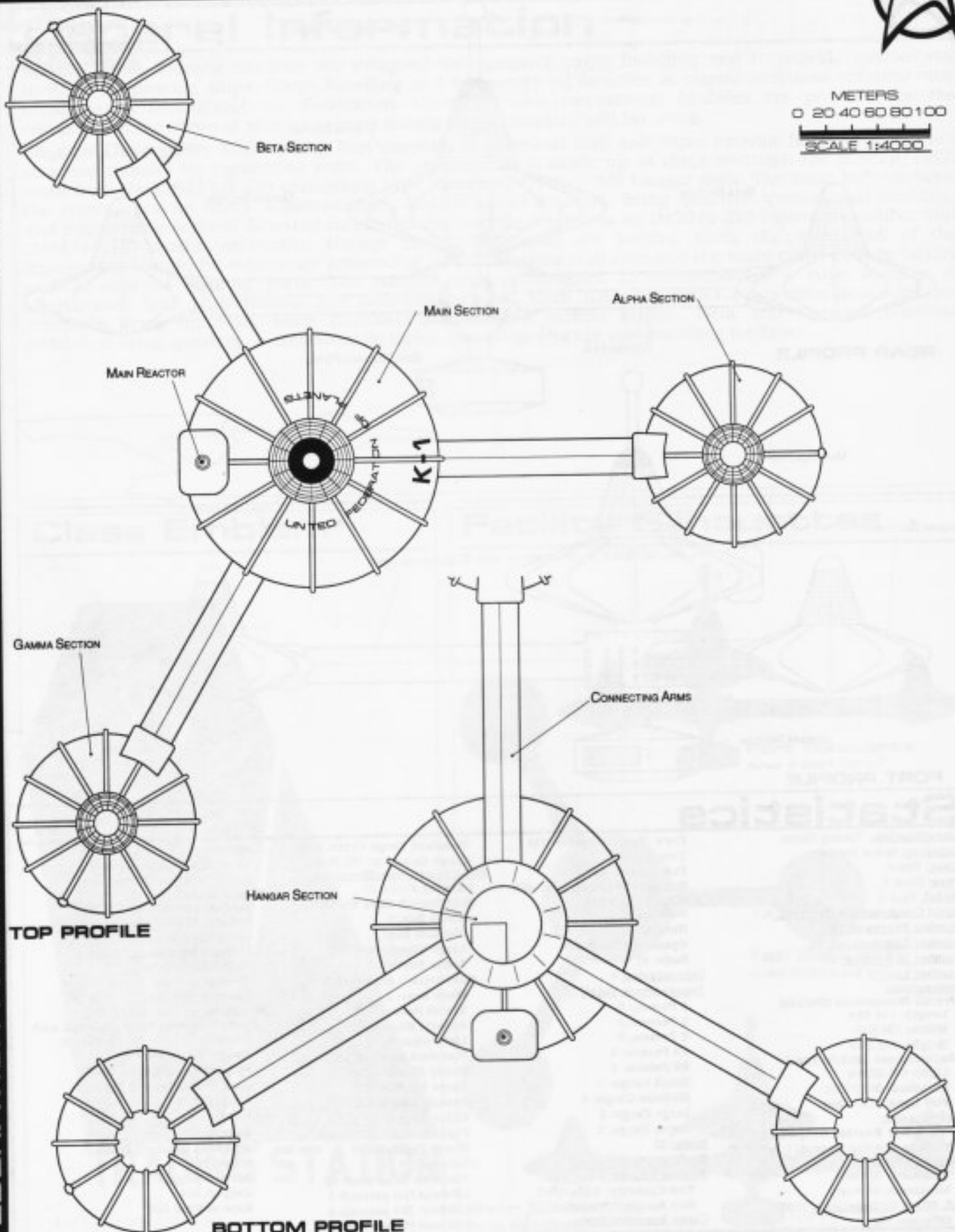

KEPLER CLASS

FEDERATION FACILITY



TRADING STATION

Facility Names

THE FOLLOWING FACILITIES OF THE TYPE K CLASS WERE AUTHORIZED BY THE AMENDED ARTICLES OF FEDERATION OF STARDATE 2282.10

KEPLER - 1 K-1*	KEPLER - 26 K-26	KEPLER - 51 K-51	KEPLER - 76 K-76
KEPLER - 2 K-2	KEPLER - 27 K-27	KEPLER - 52 K-52	KEPLER - 77 K-77
KEPLER - 3 K-3	KEPLER - 28 K-28	KEPLER - 53 K-53	KEPLER - 78 K-78
KEPLER - 4 K-4	KEPLER - 29 K-29	KEPLER - 54 K-54	KEPLER - 79 K-79
KEPLER - 5 K-5	KEPLER - 30 K-30	KEPLER - 55 K-55	KEPLER - 80 K-80
KEPLER - 6 K-6	KEPLER - 31 K-31	KEPLER - 56 K-56	KEPLER - 81 K-81
KEPLER - 7 K-7	KEPLER - 32 K-32	KEPLER - 57 K-57	KEPLER - 82 K-82
KEPLER - 8 K-8	KEPLER - 33 K-33	KEPLER - 58 K-58	KEPLER - 83 K-83
KEPLER - 9 K-9	KEPLER - 34 K-34	KEPLER - 59 K-59	KEPLER - 84 K-84
KEPLER - 10 K-10	KEPLER - 35 K-35	KEPLER - 60 K-60	KEPLER - 85 K-85
KEPLER - 11 K-11	KEPLER - 36 K-36	KEPLER - 61 K-61	KEPLER - 86 K-86
KEPLER - 12 K-12	KEPLER - 37 K-37	KEPLER - 62 K-62	KEPLER - 87 K-87
KEPLER - 13 K-13	KEPLER - 38 K-38	KEPLER - 63 K-63	KEPLER - 88 K-88
KEPLER - 14 K-14	KEPLER - 39 K-39	KEPLER - 64 K-64	KEPLER - 89 K-89
KEPLER - 15 K-15	KEPLER - 40 K-40	KEPLER - 65 K-65	KEPLER - 90 K-90
KEPLER - 16 K-16	KEPLER - 41 K-41	KEPLER - 66 K-66	KEPLER - 91 K-91
KEPLER - 17 K-17	KEPLER - 42 K-42	KEPLER - 67 K-67	KEPLER - 92 K-92
KEPLER - 18 K-18	KEPLER - 43 K-43	KEPLER - 68 K-68	KEPLER - 93 K-93
KEPLER - 19 K-19	KEPLER - 44 K-44	KEPLER - 69 K-69	KEPLER - 94 K-94
KEPLER - 20 K-20	KEPLER - 45 K-45	KEPLER - 70 K-70	KEPLER - 95 K-95
KEPLER - 21 K-21	KEPLER - 46 K-46	KEPLER - 71 K-71	KEPLER - 96 K-96
KEPLER - 22 K-22	KEPLER - 47 K-47	KEPLER - 72 K-72	
KEPLER - 23 K-23	KEPLER - 48 K-48	KEPLER - 73 K-73	
KEPLER - 24 K-24	KEPLER - 49 K-49	KEPLER - 74 K-74	
KEPLER - 25 K-25	KEPLER - 50 K-50	KEPLER - 75 K-75	

*CLASS FACILITY. **LOST IN THE LINE OF DUTY. ***PROPOSED. ALL NAMES PRECEDED WITH "UPP"

Tractor Beam Specifications

Primary Tractor Beam Load Calculator

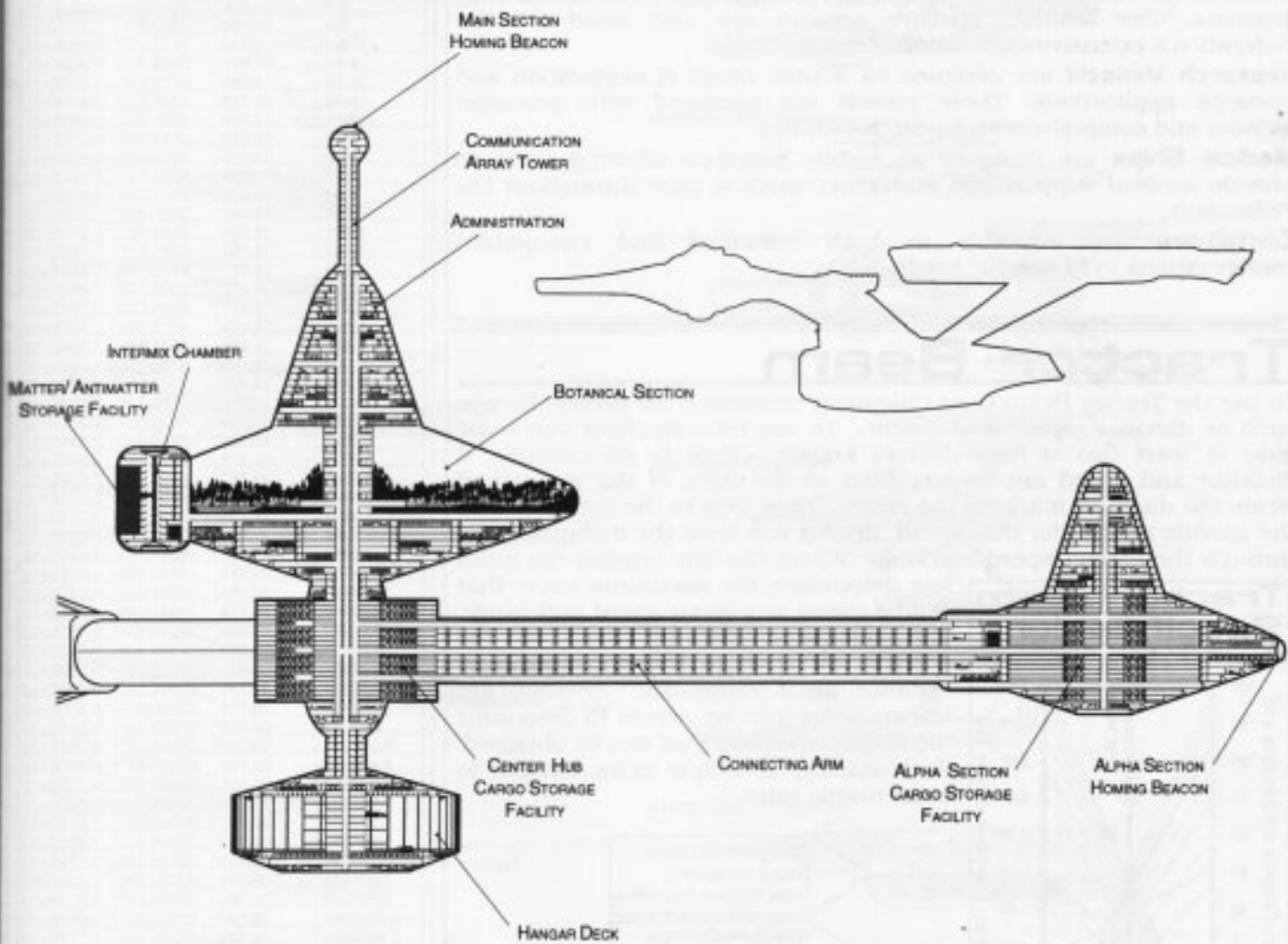
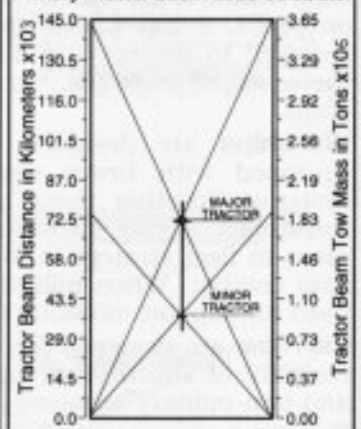

CROSS SECTION
ENLARGED FOR CLARITY
SRM2 03:02:04:04

KEPLER CLASS

FEDERATION FACILITY

STARSHIPS



General Information

Starfleet requires a large fleet of ships for the protection and exploration of the vastness of space. Although the Federation is built on peace, it has found that both peacetime and military vessels are required to protect and support the Federation. This chapter covers these ships: warships, carriers, scouts, research vessels and medical ships.

Warships are designed for defense of the Federation. They are equipped with heavy weapons, shields and more powerful drive systems. Together these allow warships to respond to threats and counteract enemy operations. One of the primary roles the warship plays in fleet strategy is to effectively engage enemy vessels in ship to ship combat. When military action is not necessitated, the ships are used for support missions throughout the Federation.

Carriers are designed for the support, transportation, launching and recovery of shuttlecraft, fighters and other small craft. Both military and non-military missions are within the scope of carrier operations.

Scouts have a two-fold role in Federation policy: forward observation and exploration. They are equipped with extensive sensor arrays, heavy weapons and shields. This equipment allows scouts to move in advance of Federation ships on observation and reconnaissance missions. The scouts' extensive sensors are also used for the Federation's extensive exploration of space.

Research Vessels are designed for a wide range of exploration and research applications. These vessels are equipped with precision sensors and comprehensive research facilities.

Medical Ships are designed as mobile hospitals allowing them to provide medical support and emergency medical care throughout the Federation.

Containers are available in both standard and customized configurations to fit specific needs.

Tractor Beam

To use the Tractor Beam Load Calculator determine the needed factors such as distance, speed and weight. To use the calculator you must have at least two of these factors known. Here is an example, if distance and speed are known, start at the right of the graph and locate the distance mark for the range. Then look to the center to find the gravitic neutral for that speed, draw a line from the distance mark through the correct speed marking. Where the line crosses the mass line determines the maximum mass that can be towed at a given speed and range.

The calculator can be used in the opposite direction to find the maximum distance or if range and distance are known a line can be drawn to determine the maximum speed that can be obtained. Each starship is unique in its distance to mass towing ratio.

Tractor Beam Specifications

Primary Tractor Beam Load Calculator

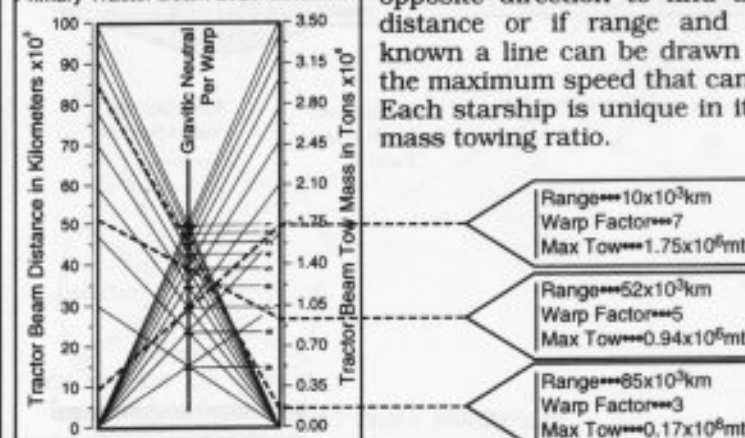

Warp Conversion

NEW WARP NUMBER	OLD WARP NUMBER	MULTIPLE OF LIGHT PER SECOND	KILOMETERS PER SECOND
1.0	1.000	1.000	3.000E+08
1.5	1.500	3.375	1.013E+09
2.0	2.000	8.000	2.400E+09
2.5	2.500	15.625	4.688E+09
3.0	3.000	27.000	8.100E+09
3.5	3.500	42.875	1.286E+10
4.0	4.000	64.000	1.920E+10
4.5	4.500	91.125	2.734E+10
5.0	5.000	125.000	3.750E+10
5.5	5.500	166.375	4.991E+10
6.0	6.000	216.000	6.480E+10
6.5	6.500	274.825	8.239E+10
7.0	7.000	343.000	1.029E+11
7.5	7.500	421.875	1.266E+11
8.0	8.000	512.000	1.536E+11
8.5	8.500	614.125	1.842E+11
9.0	9.000	729.000	2.187E+11
9.1	9.146	765.055	2.295E+11
9.2	9.247	790.555	2.372E+11
9.3	9.347	816.615	2.450E+11
9.4	9.448	843.242	2.530E+11
9.5	9.548	870.441	2.611E+11
9.6	9.649	898.219	2.696E+11
9.7	10.034	1010.245	3.031E+11
9.8	10.638	1203.979	3.612E+11
9.9	11.739	1617.612	4.853E+11
9.91	11.908	1688.707	5.066E+11
9.92	12.098	1770.638	5.312E+11
9.93	12.313	1866.633	5.600E+11
9.94	12.560	1981.553	5.945E+11
9.95	12.833	2123.180	6.370E+11
9.96	13.210	2305.081	6.915E+11
9.97	13.689	2554.007	7.662E+11
9.98	14.316	2934.319	8.803E+11
9.99	15.432	3675.405	1.103E+12
9.991	15.604	3799.421	1.140E+12
9.992	15.797	3941.975	1.183E+12
9.993	16.017	4108.788	1.233E+12
9.994	16.272	4308.539	1.293E+12
9.995	16.577	4555.250	1.367E+12
9.996	16.954	4873.590	1.462E+12
9.997	17.449	5312.688	1.594E+12
9.998	18.163	5992.066	1.798E+12
9.999	19.437	7343.184	2.203E+12
9.9991	19.637	7572.248	2.272E+12
9.9992	19.863	7836.429	2.351E+12
9.9993	20.121	8146.662	2.444E+12
9.9994	20.424	8519.567	2.556E+12
9.9995	20.787	8962.026	2.685E+12
9.9996	21.239	9581.403	2.874E+12
9.9997	21.836	10412.178	3.124E+12
9.9998	22.705	11704.576	3.511E+12
9.9999	24.267	14291.193	4.287E+12
9.99991	24.514	14731.166	4.419E+12
9.99992	24.792	15238.967	4.572E+12
9.99993	25.112	15835.749	4.751E+12
9.99994	25.486	16533.658	4.966E+12
9.99995	25.935	17444.704	5.233E+12
9.99996	26.496	18600.541	5.580E+12
9.99997	27.236	20204.037	6.061E+12
9.99998	28.315	22700.887	6.810E+12
9.99999	30.258	27703.301	8.311E+12
9.999991	30.565	28554.627	8.566E+12
9.999992	30.912	29537.311	8.861E+12
9.999993	31.310	30692.322	9.208E+12
9.999994	31.775	32081.924	9.625E+12
9.999995	32.335	33806.861	1.014E+13
9.999996	33.033	36044.671	1.081E+13
9.999997	33.885	39149.589	1.174E+13
9.999998	35.289	43984.996	1.320E+13
9.999999	37.721	53674.040	1.610E+13
9.9999991	38.104	55323.067	1.660E+13
9.9999992	38.536	57226.564	1.717E+13
9.9999993	39.032	59463.899	1.784E+13
9.9999994	39.612	62155.694	1.865E+13
9.9999995	40.309	65497.121	1.965E+13
9.9999996	41.180	69832.116	2.095E+13
9.9999997	42.330	75846.938	2.275E+13
9.9999998	44.005	85214.189	2.556E+13
9.9999999	47.024	103984.404	3.120E+13



STARSHIPS

Size Comparison

GENERAL INFORMATION

Assault Cruiser



Heavy Shuttlecraft Carrier



Battle Cruiser



Through Deck Carrier

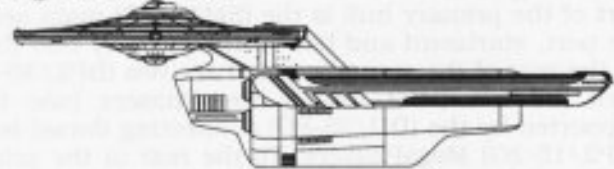

Battleship

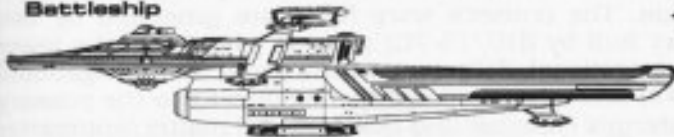

Through Deck Cruiser

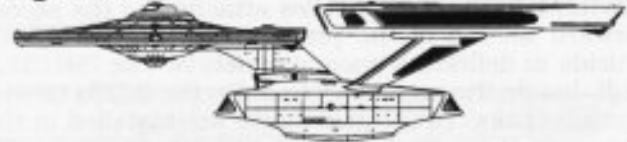

Escort Cruiser



Exploration Cruiser



Gun Boat



Research Vessel



Light Corvette



Star Cruiser

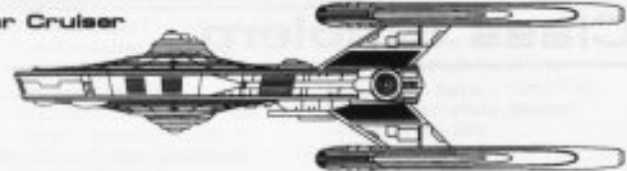

Penetration Cruiser



Survey Cruiser



Strike Cruiser



Troop Transport



Timeslip Cruiser



Heavy Scout



Hospital Frigate



Scout



Hospital Ship



METERS
0 20 40 60 80 100
SCALE 1:4000

FEDERATION VESSELS

ATTACK CRUISER



General Information

Specific Role: The Attack Cruiser is a high powered, fast response weapons platform. Equipped with powerful shields, sensors and extensive ECM gear, the Attack Cruiser, with its narrow front silhouette, is one of the most survivable ships in the fleet. The secondary hull is connected directly to the primary hull in order to reduce the craft's silhouette.

Physical Description: The (PH147/A-M2) primary hull is equipped with additional targeting sensors, hull reinforcements and a small hangar deck (located on the upper starboard side). Integrated into the standard deflector grid are additional electronic counter-measures to make the vessel more stealthy. On the lower part of the primary hull is the (SM49/2S) main sensor array and (DN4/3N) navigational dome. Located on the port, starboard and bow of the primary hull (both top and bottom) are six (BP2/30-2C) phaser banks. To the rear of the secondary hull are two (BP2/30-2C) phaser banks. Mounted on the primary hull's upper deck are two (MP2/15-2G) MegaPhasers (one to port, one to starboard). Below the secondary hull supported by the (DU/25-8U) connecting dorsal is a (PB4/50-10E) photon torpedo pod with side mounted (MP2/15-2G) MegaPhasers. To the rear of the primary hull are (IRF35E/3-ED) dual impulse units which are used for auxiliary power and sub-warp propulsion. The cruiser's warp fields are generated by two (SW52/1-5FR) warp nacelles attached to the secondary hull by (DU/15-7G) support pylons. On the lower forward section of the primary hull are (DN4/A-1) navigational deflectors which assist the navigational shields in deflecting oncoming debris. The (SH132/A-F4) secondary hull is attached directly to the primary hull. Inside the secondary hull are the (M25/12-2H) intermix chamber and (AM8/45-5S) matter/antimatter storage tanks. The storage tanks are installed in the rear of the secondary hull for emergency jettisoning. In the event of an emergency the primary and secondary hulls can separate; each being able to carry the ships full complement. Once separated the primary hull can maneuver on impulse power for extended periods of time.

Class Emblem

ATTACK CRUISER



ROSENZWEIG CLASS

Ship Silhouettes

Total Target Area 34598.40 m²

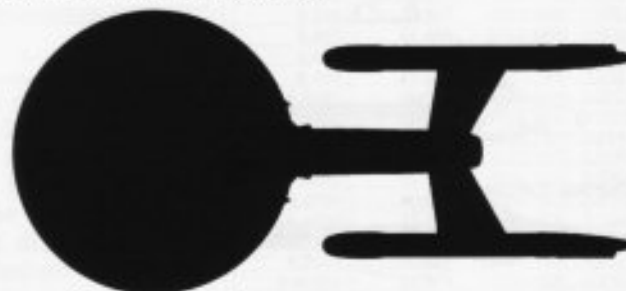

Top Silhouette
Area 25665.04 m²

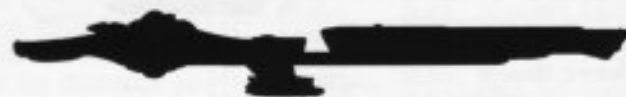

Port Silhouette
Area 6050.08 m²



Front Silhouette
Area 2882.28 m²



ATTACK CRUISER

ROSENZWEIG CLASS

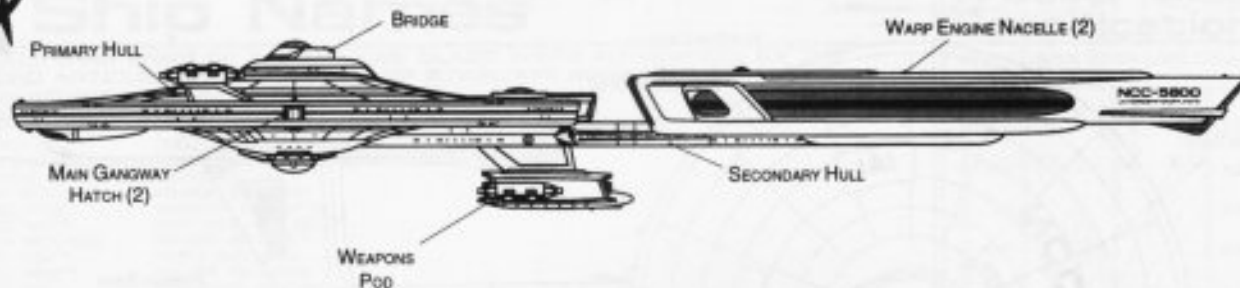

PORT PROFILE

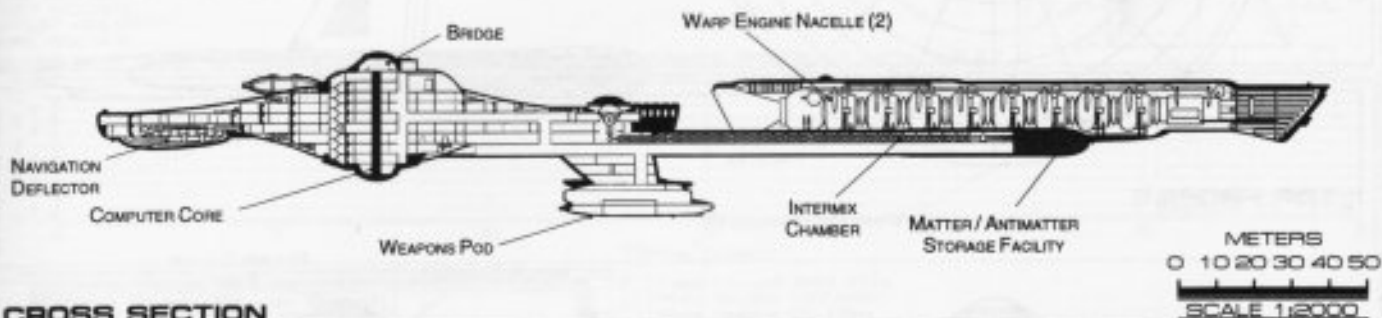

CROSS SECTION

Statistics

Classification: Attack Cruiser
Category: Assault Ship
Class: Rosenzweig
Type: Class 1
Model: MK-XXIII
Naval Construction Contract: 5600
Number Proposed: 38
Number Constructed: 28
Number in Service: 26
Number Lost: 2
Dimensions:
Overall Dimensions (Meters)
 Length: 310.40m
 Width: 141.72m
 Height: 42.12m
Primary Hull Dimensions (Meters)
 Length: 146.31m
 Width: 141.72m
 Height: 32.94m
Secondary Hull Dimensions (Meters)
 Length: 168.59m
 Width: 23.66m
 Height: 6.03m
Warp Unit Dimensions (Meters)
 Length: 154.81m
 Width: 12.63m
 Height: 18.32m
Displacement (Metric Tons)
 Light: 153,477mt
 Standard: 174,433mt
 Full Load: 183,560mt
Performance:
Impulse Units: Dual Unit (IRF35E/3-ED)
Impulse Engine Output: 7.8×10^{13} W
Impulse Power Index: 1.200
Max Cruising: C
Acceleration Rate:
 0.00-0.25 Impulse: 0.166 sec.
 0.25-0.50 Impulse: 0.250 sec.
 0.50-0.75 Impulse: 0.330 sec.
 0.75-Full Impulse: 0.416 sec.
Warp Units: 2 Nacelle Units (SW52/1-5FR)
Warp Engine Output: 1.2×10^{15} W
Warp Power Index: 1.200

Optimum Speed: Warp 5
Max. Safe Cruising: Warp 7
Emergency Speed: Warp 8.5
Max. Speed: Warp 9.3
Destructive Speed: Warp 9.38
Acceleration Power: 3.0
Acceleration Times:
 Warp 1 - Warp 2: 0.166 sec.
 Warp 2 - Warp 3: 0.266 sec.
 Warp 3 - Warp 4: 1.007 sec.
 Warp 4 - Warp 5: 1.448 sec.
 Warp 5 - Warp 6: 1.548 sec.
 Warp 6 - Warp 7: 1.673 sec.
 Warp 7 - Warp 8: 2.148 sec.
 Warp 8 - Warp 9: 3.072 sec.
 Warp 9 - Warp 9.5: 6.826 sec.
 Warp 9.5 - Warp 9.75: 7.908 sec.
 Warp 9.75 - Warp 9.9: 16.396 sec.
Duration (Years)
 Standard: 4 Years
 Maximum: 16 Years
Std. Ships Complement: 385
 Officers: 62
 Crew (Ensign Grade): 300
 Troops: 23
 Passengers: 32
 Emergency condition: +501
Medical Facilities:
 Doctors: 4
 Nurses: 21
 Operating Rooms: 3
 Beds: 21
Laboratories: 5
Transporters Total: 10
 1 Person: 0
 2 Person: 0
 6 Person: 4
 12 Person: 0
 22 Person: 4
 Small Cargo: 1
 Medium Cargo: 1
 Large Cargo: 0
 Super Cargo: 0

Brigs: 19
Replicators: 12
Tractor Beams: 1
 Tow Capacity: 4.2×10^6 mt
 Max Range: 1.05×10^5 km
Cargo Specifications:
 Standard Cargo Units: 255
 Cargo Capacity: 12,750mt
Shuttlecraft Specifications:
 Docking Ports: 3
 Shuttlecraft Bays Total: 1
 Small Bay: 1
 Medium Bay: 0
 Large Bay: 0
 Super Bay: 0
 Shuttlecraft Standard: 18
 Work Bees: 1
 Travel Pods: 1
 Aquatic Shuttle: 0
 Light Shuttle: 1
 Standard Shuttle: 4
 Heavy Shuttle: 1
 Light Cargo Shuttle: 1
 Assault Shuttle: 3
 Killer Bees: 2
 Fighter: 2
 Heavy Fighter: 2
 Lifeboats: 42
 Turbolift (8 person): 23
 Lifeboat (10 person): 13
 Lifeboat (20 person): 6
 Lifeboat (30 person): 0
Cloaking Devices: 0
Sensor Index Values:
 Planetary Survey: 0.9272
 Stellar Survey: 0.7855
 Short Range: 1.1762
 Long Range: 0.9711
 Navigation: 1.2393
 Special: 1.1138
Computers: 2
 Type: Daystrom Duotronic IIIa
 Type: Daystrom Duotronic IIId

ECM Index: 1.50
Shield Rating:
 Shield Index: 1.19
 Holdoff Power: 3.22×10^{12} W
 Refresh Rate: 9.15×10^{11} W
 Breakdown Rate: 1.10×10^{12} W
Shield Dimensions (Meters)
 Length: 392.09m
 Width: 177.01m
 Height: 53.21m
Weapons:
Phaser Power Index: 2.32
Photon Power Index: 5.77
Vessel Power Index: 4.04
Weapon Placement:
Beam (Phasers) Total: 5 banks 2 each
 Output: 5.0×10^{11} W / 2.5×10^{11} W
 Range: 2.5×10^5 km
 Rate of Fire: 30 ppm / Cont.
 Forward Banks: 2
 Rear Banks: 1
 Port Banks: 2
 Starboard Banks: 2
 Upper Banks: 0
 Lower Banks: 0
Beam (MegaPhasers) Total: 4
 Output: 2.6×10^{12} W / 1.3×10^{12} W
 Range: 1.0×10^5 km
 Rate of Fire: 15 ppm / Cont.
 Forward/Rear Banks: 0
 Port/Starboard Banks: 0
 Upper/Lower Banks: 4
Torpedoes (Photon) Total: 2 Bay 2 each
 Stock: 60
 Range: 2.0×10^5 km
 Output: 10-50 Megatons
 Rate of Fire: 10 spm
 Forward Bay: 1
 Rear Bay: 1
 Port Bay: 0
 Starboard Bay: 0
 Upper Bay: 0
 Lower Bay: 0

FEDERATION VESSEL

ATTACK CRUISER



ROSENZWEIG CLASS

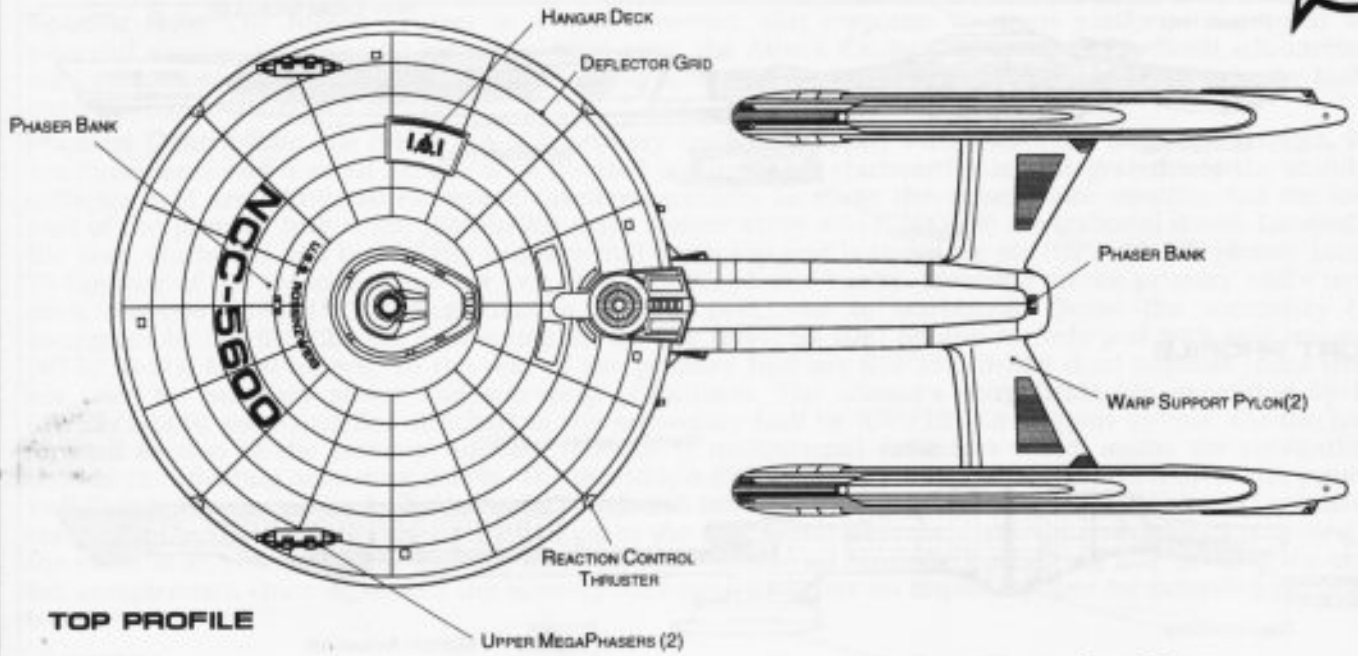

TOP PROFILE

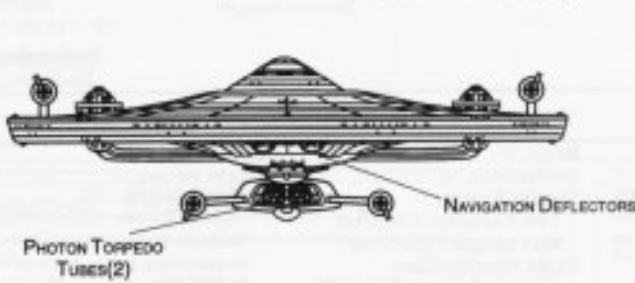

FRONT PROFILE

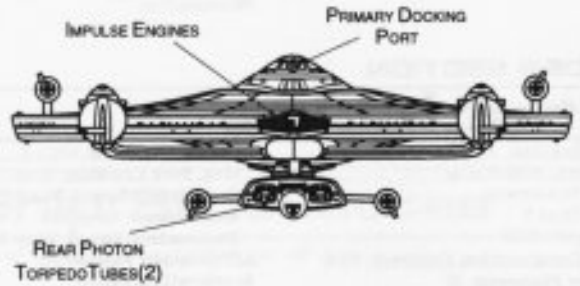

REAR PROFILE

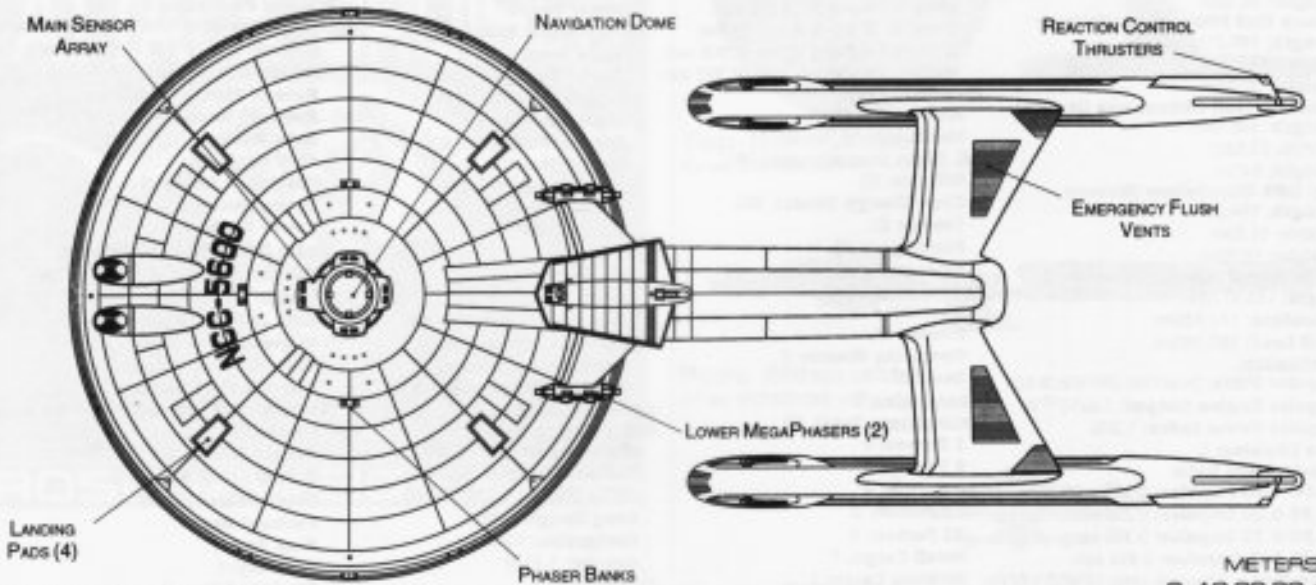

BOTTOM PROFILE

METERS
0 10 20 30 40 50
SCALE 1/2000

FEDERATION VESSEL

ATTACK CRUISER



Ship Names

THE FOLLOWING SHIPS OF THE MK-XXIII CLASS WERE AUTHORIZED BY THE AMENDED ARTICLES OF FEDERATION OF STARDATE 2268.11

ABERCROMBIE *NCC-5619	ROSENZWEIG *NCC-5600*
BOTELLO *NCC-5604	SALAZAR *NCC-5618
CHAVEZORAT *NCC-5601	STEVENSON *NCC-5624
DEERMAN *NCC-5632***	TABARES *NCC-5615**
DENNING *NCC-5611	TIPPIE *NCC-5607
ENOX *NCC-5617	UNGER *NCC-5636***
FALKENBURY *NCC-5614	VANNOY *NCC-5620
FLYGARE *NCC-5626	WHEELER *NCC-5616
GOGGIN *NCC-5610**	WHITCHER *NCC-5633***
HUTCHERSON *NCC-5608	WINGER *NCC-5627
IBARRA *NCC-5634***	WYBLE *NCC-5603
IRLBECK *NCC-5630***	YAEGER *NCC-5625
JOSEPH *NCC-5622	ZINSMEYER *NCC-5621
KENDRICK *NCC-5602	
LESLEY *NCC-5637***	
LONGANECKER *NCC-5605	
McCAIN *NCC-5628***	
MONTEFUSCO *NCC-5623	
NEUGEBAUER *NCC-5635***	
ONTIVEROZ *NCC-5629***	
PARKMAN *NCC-5609	
QUINT *NCC-5606	
RANEY *NCC-5612	
RATCLIFF *NCC-5631***	
REBEL *NCC-5613	

*CLASS SHIP, **LOST IN THE LINE OF DUTY, ***PROPOSED. ALL NAMES PRECEDED WITH "U.S.S."

Tractor Beam Specifications

Primary Tractor Beam Load Calculator

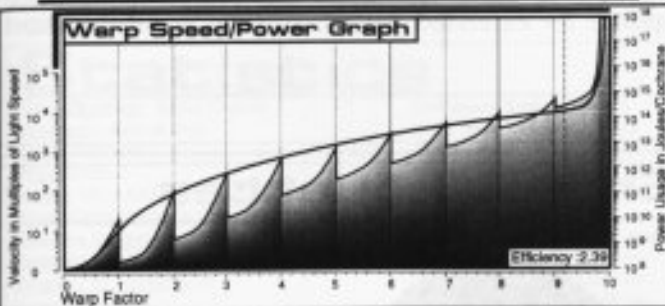
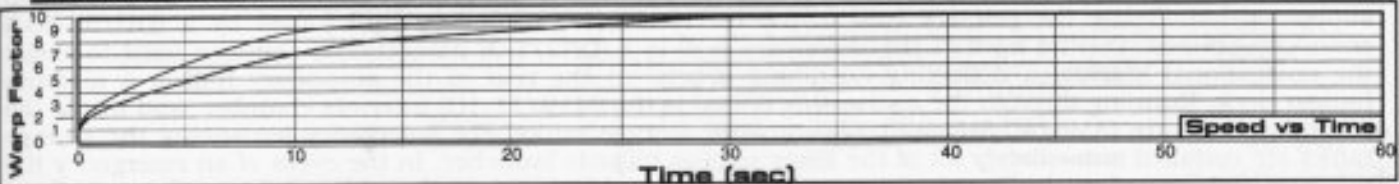
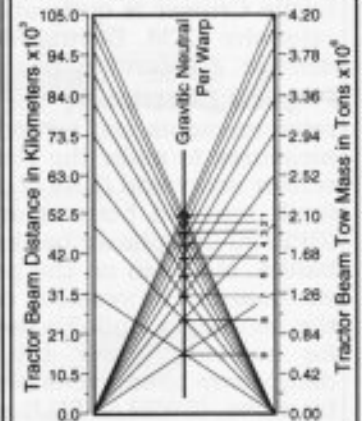

Field Length 859.41m
Field Width 197.20m
Field Height 88.13m



Front Warp Field Profile
Cross Section Area 12419.6 m²

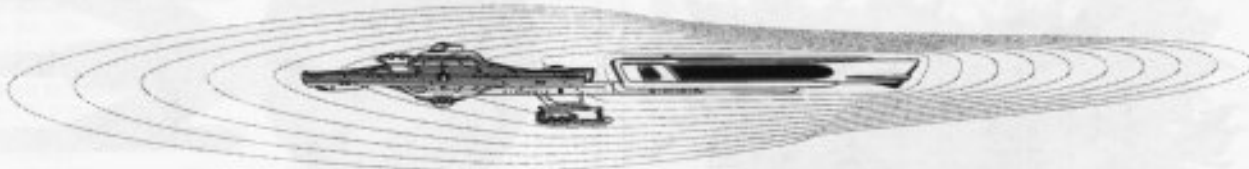

Port Warp Field Profile
Cross Section Area 38219.48 m²

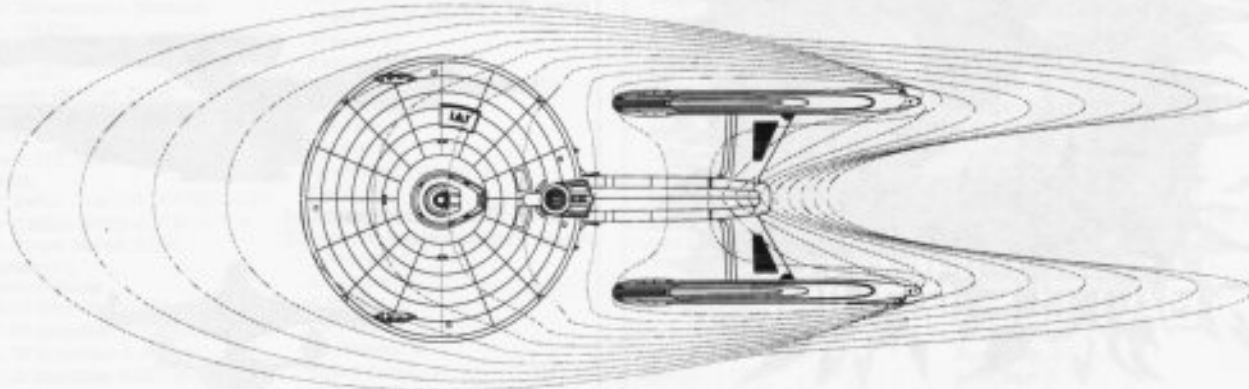

Top Warp Field Profile
Cross Section Area 89392.58 m²

WARP FIELDS

SRM2 04:02:01:04

STARFLEET REFERENCE MANUAL

ROSENZWEIG CLASS

FEDERATION VESSEL

BATTLE CRUISER



General Information

Specific Role: Designed to move into hostile situations and deliver large amounts of support firepower, the Battle Cruiser is quite able to take a beating. It is equipped with more powerful shields and sensors and extensive ECM. During military operations, the cruiser is used as a point assault ship and for main-line defense. A secondary mission for the Battle Cruiser is extended duration, long range patrol duty.

Physical Description: The (PH147/A-M2) primary hull is equipped with additional targeting sensors, hull reinforcements and weapons. Integrated into the standard deflector grid are additional electronic counter-measures to make the vessel more stealthy. On the lower part of the primary hull is the (SM49/8F) main sensor array and (DN4/7-H) navigational dome. Located on the port, starboard and bow of the primary hull (both top and bottom) are six (BP2/30-2C) phaser banks. To the rear of the secondary hull are two (BP2/30-2C) phaser banks. On the underside of the secondary hull are two additional (BP2/30-2C) phaser banks. Mounted on the primary hull's upper deck are two (MP2/15-2G) MegaPhasers (one to port, one to starboard). The vessel is equipped with dual (PB4/25-10R) photon torpedo bays mounted above and below the secondary hull. To the rear of the primary hull are (IRF35E/5-CD) dual impulse units which are used for auxiliary power and sub-warp propulsion. The vessel is also equipped with additional inertial dampeners to compensate for its increased maneuvering capabilities. The vessel's warp fields are generated by three (SW52/1-5UJ) warp nacelles. The outboard nacelles are attached to the secondary hull by (DU/42-5H) support pylons while the third nacelle is attached to the primary hull by a (DU/28-5G) dorsal support pylon. Below the primary hull is the (SH132/C-H3) secondary hull joined by a (DU/55-5UJ) connecting dorsal. On the front of the secondary hull is a (DN2/T-3) navigational deflector used to assist the navigational shields in deflecting oncoming debris. At the rear of the secondary hull is a medium hangar deck. Running through the connecting dorsal is the (M19/11-1G) intermix chamber, and inside the secondary hull are (AM8/40-5U) matter/antimatter storage tanks. For emergency jettisoning the storage tanks are installed immediately aft of the lower photon torpedo launcher. In the event of an emergency the primary and secondary hulls can separate; each being able to carry the ships full complement. Once separated the primary hull can maneuver on impulse power for extended periods of time, or, if the third nacelle is still attached, minimal warp speeds.

Class Emblem



Ship Silhouettes

Total Target Area 41881.40 m²

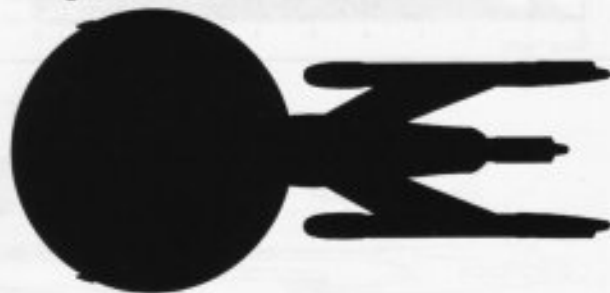

Top Silhouette
Area 27073.16 m²



Port Silhouette
Area 11249.54 m²



Front Silhouette
Area 358.80 m²



BATTLE CRUISER

FIRESTONE CLASS

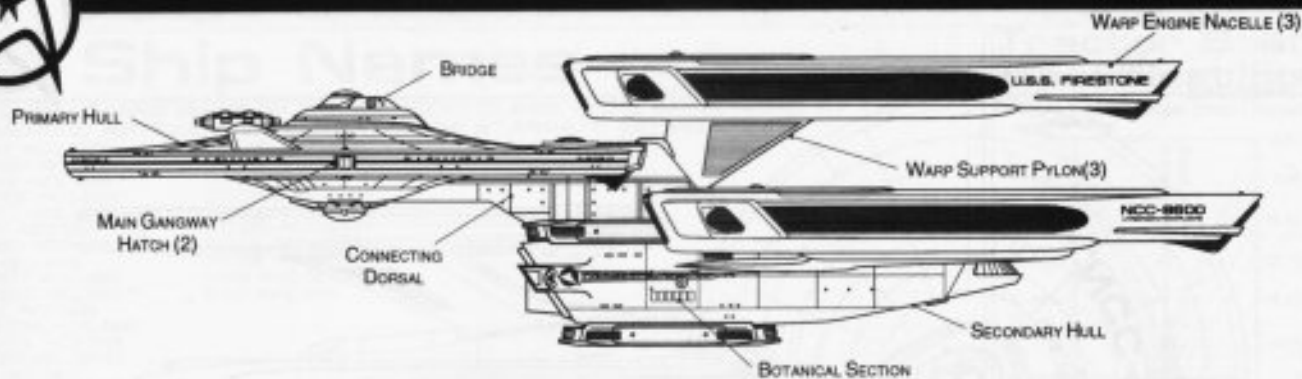

PORT PROFILE

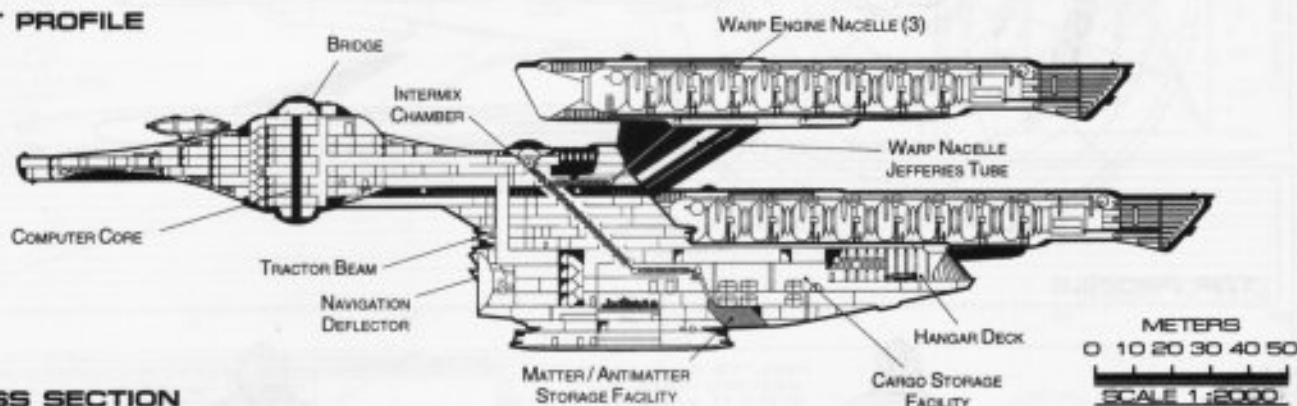

CROSS SECTION

Statistics

Classification: Battle Cruiser
Category: Assault Ship
Class: Firestone
Type: Class 1
Model: MK-XXXII
Naval Construction Contract: 8600
Number Proposed: 35
Number Constructed: 30
Number in Service: 29
Number Lost: 1
Dimensions:
Overall Dimensions (Meters)
 Length: 301.50m
 Width: 141.74m
 Height: 73.25m
Primary Hull Dimensions (Meters)
 Length: 146.31m
 Width: 141.72m
 Height: 32.94m
Secondary Hull Dimensions (Meters)
 Length: 125.84m
 Width: 37.07m
 Height: 21.51m
Warp Unit Dimensions (Meters)
 Length: 154.81m
 Width: 12.63m
 Height: 18.32m
Displacement (Metric Tons)
 Light: 216,231mt
 Standard: 231,785mt
 Full Load: 258,736mt
Performance:
Impulse Units: Dual Unit (IRF35E/5-CD)
Impulse Engine Output: 7.8×10^{13} W
Impulse Power Index: 0.850
Max Cruising: C
Acceleration Rate:
 0.00-0.25 Impulse: 0.235 sec.
 0.25-0.50 Impulse: 0.352 sec.
 0.50-0.75 Impulse: 0.469 sec.
 0.75-Full Impulse: 0.587 sec.
Warp Units: 3 Nacelle Units (SW52/1-5UJ)
Warp Engine Output: 1.8×10^{15} W
Warp Power Index: 1.280

Optimum Speed: Warp 5
Max. Safe Cruising: Warp 7
Emergency Speed: Warp 8.5
Max. Speed: Warp 9.25
Destructive Speed: Warp 9.35
Acceleration Power: 3.0
Acceleration Times:
 Warp 1 - Warp 2: 0.156 sec.
 Warp 2 - Warp 3: 0.250 sec.
 Warp 3 - Warp 4: 0.946 sec.
 Warp 4 - Warp 5: 1.361 sec.
 Warp 5 - Warp 6: 1.455 sec.
 Warp 6 - Warp 7: 1.572 sec.
 Warp 7 - Warp 8: 2.018 sec.
 Warp 8 - Warp 9: 2.886 sec.
 Warp 9 - Warp 9.5: 6.414 sec.
 Warp 9.5 - Warp 9.75: 7.431 sec.
 Warp 9.75 - Warp 9.9: 15.410 sec.
Duration (Years)
 Standard: 5 Years
 Maximum: 20 Years
Std. Ships Complement: 450
Officers: 72
Crew (Ensign Grade): 351
Troops: 27
Passengers: 48
Emergency condition: +599
Medical Facilities:
 Doctors: 5
 Nurses: 26
 Operating Rooms: 4
 Beds: 26
Laboratories: 7
Transporters Total: 12
 1 Person: 0
 2 Person: 0
 6 Person: 4
 12 Person: 0
 22 Person: 4
 Small Cargo: 2
 Medium Cargo: 2
 Large Cargo: 0
 Super Cargo: 0

Brigs: 27
Replicators: 18
Tractor Beams: 1
 Tow Capacity: 5.37×10^6 mt
 Max Range: 1.14×10^5 km
Cargo Specification:
 Standard Cargo Units: 393
 Cargo Capacity: 19,650 mt
Shuttlecraft Specifications:
 Docking Ports: 4
 Shuttlecraft Bays Total: 1
 Small Bay: 0
 Medium Bay: 1
 Large Bay: 0
 Super Bay: 0
 Shuttlecraft Standard: 30
 Work Bees: 2
 Travel Pods: 2
 Aquatic Shuttle: 1
 Light Shuttle: 1
 Standard Shuttle: 6
 Heavy Shuttle: 1
 Cargo Shuttle: 1
 Assault Shuttle: 3
 Killer Bees: 4
 Fighter: 5
 Heavy Fighter: 4
 Lifeboats: 47
 TurboLift (8 person): 23
 Lifeboat (10 person): 17
 Lifeboat (20 person): 7
 Lifeboat (30 person): 1
Cloaking Devices: 0
Sensor Index Values:
 Planetary Survey: 0.9359
 Stellar Survey: 0.7714
 Short Range: 1.2117
 Long Range: 0.9987
 Navigation: 1.2158
 Special: 1.0281
Computers: 2
 Type: Daystrom Duotronic IIIp
 Type: Daystrom Duotronic IIw

ECM Index: 1.35
Shield Rating:
 Shield Index: 1.02
 Holdoff Power: 3.87×10^{12} W
 Refresh Rate: 1.10×10^{12} W
 Breakdown Rate: 1.32×10^{12} W
Shield Dimensions (Meters)
 Length: 380.86m
 Width: 177.01m
 Height: 92.52m
Weapons:
Phaser Power Index: 1.15
Photon Power Index: 16.36
Vessel Power Index: 8.76
Weapon Placement:
Beam (Phasers) Total: 7 banks 2 each
 Output: 5.0×10^{11} W / 2.5×10^{11} W
 Range: 2.5×10^5 km
 Rate of Fire: 30 ppm / Cont.
 Forward Banks: 2
 Rear Banks: 1
 Port Banks: 2
 Starboard Banks: 2
 Upper Banks: 0
 Lower Banks: 0
Beam (MegaPhasers) Total: 2
 Output: 2.6×10^{12} W / 1.3×10^{12} W
 Range: 1.0×10^6 km
 Rate of Fire: 15 ppm / Cont.
 Forward/Rear Banks: 2
 Port/Starboard Banks: 0
 Upper/Lower Banks: 0
Torpedoes (Photon) Total: 4 Bay 2 each
 Stock: 120
 Range: 2.0×10^6 km
 Output: 10-50 Megatons
 Rate of Fire: 10 spm
 Forward Bay: 2
 Rear Bay: 2
 Port Bay: 0
 Starboard Bay: 0
 Upper Bay: 0
 Lower Bay: 0

FEDERATION VESSEL

BATTLE CRUISER



FIRESTONE CLASS

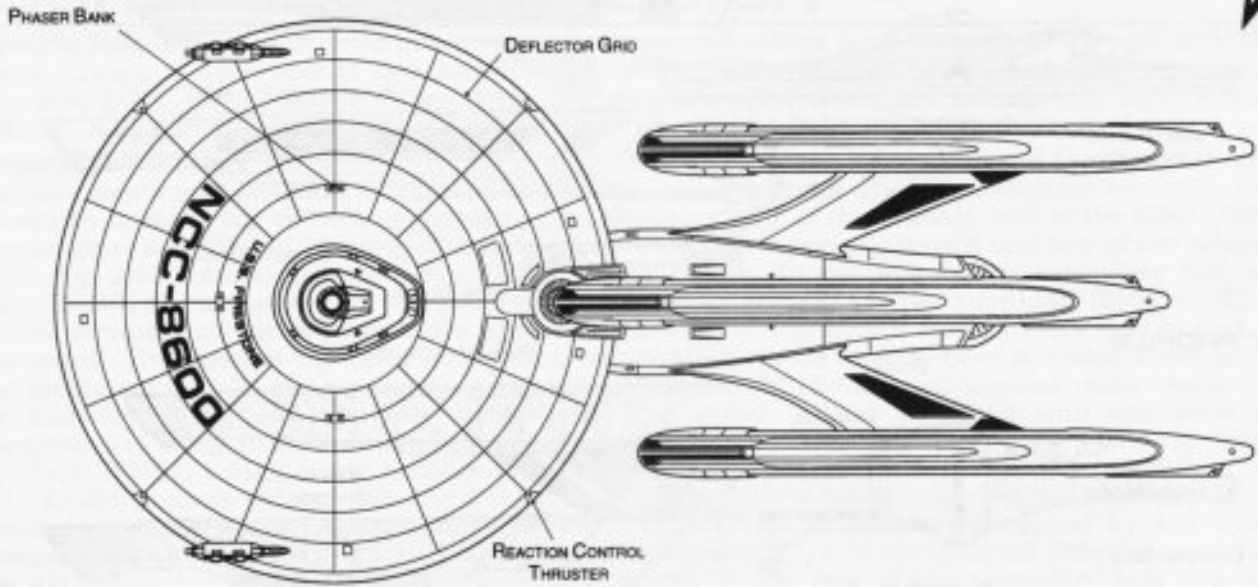

TOP PROFILE

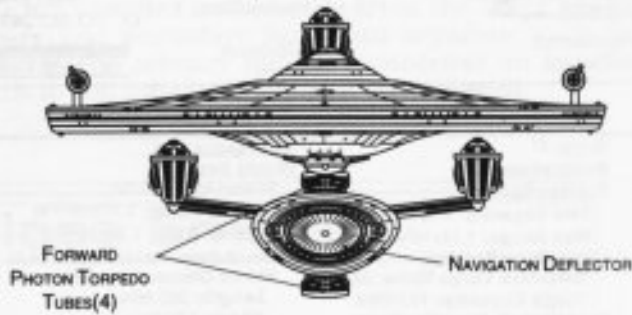

FRONT PROFILE

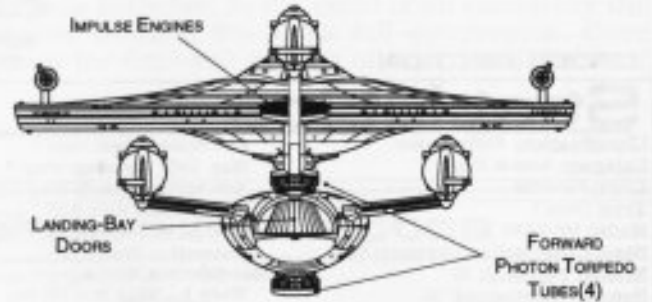

REAR PROFILE

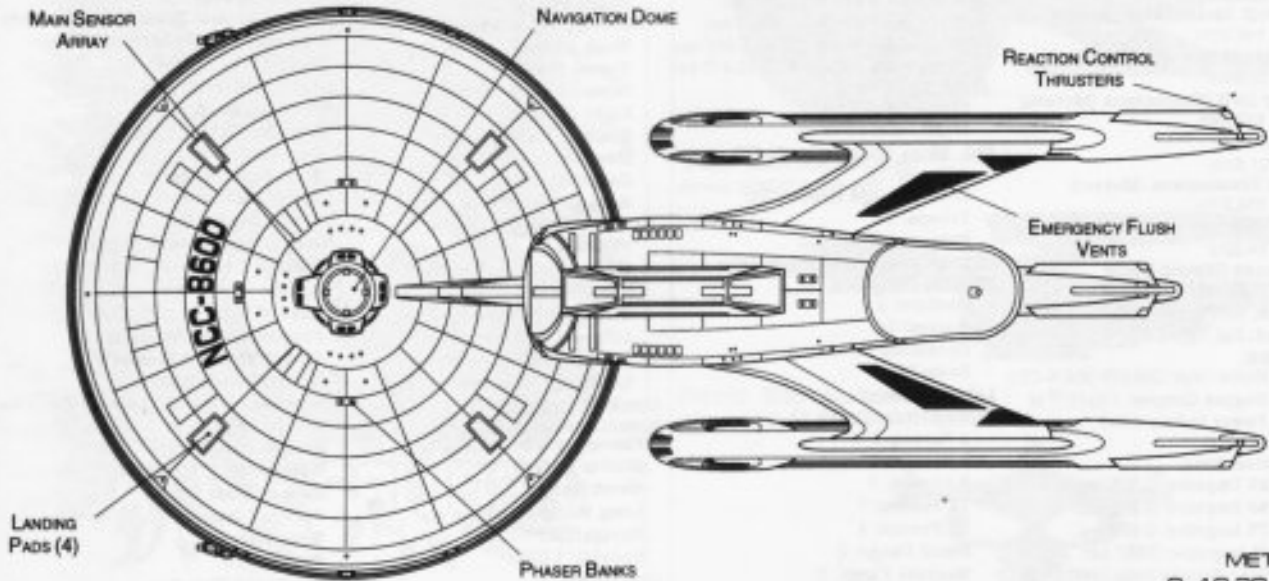

BOTTOM PROFILE

METERS
0 10 20 30 40 50
SCALE 1:2000

FEDERATION VESSEL



BATTLE CRUISER

Ship Names

THE FOLLOWING SHIPS OF THE MK-XXXII CLASS WERE AUTHORIZED BY THE AMENDED ARTICLES OF FEDERATION OF STARDATE 2271.6

- | | |
|-----------------------|-----------------------|
| ADKINS *NCC-8607 | PHILLIPS *NCC-8630*** |
| ALM *NCC-8615 | QUALIA *NCC-8633*** |
| ALMACK *NCC-8629 | RIOS *NCC-8622 |
| BORNICK *NCC-8624 | SCUDDER *NCC-8605 |
| BOSKET *NCC-8606 | THORNLEY *NCC-8601 |
| CLARY *NCC-8621 | UTZMZN *NCC-8603 |
| COOPER *NCC-8612 | VANCE *NCC-8632*** |
| DIAZ *NCC-8623 | WELSH *NCC-8619 |
| DURRETT *NCC-8620 | YANG *NCC-8610** |
| ESPOSITO *NCC-8631*** | ZAHN *NCC-8606 |
| ESTILL *NCC-8625 | |
| FIRESTONE *NCC-8600* | |
| FONDREN *NCC-8616 | |
| FRAZIER *NCC-8614 | |
| GIST *NCC-8617 | |
| GOOCH *NCC-8604 | |
| HARVICK *NCC-8611 | |
| HILTBRUNNER *NCC-8627 | |
| INGLE *NCC-8634*** | |
| JOLIFF *NCC-8602 | |
| KOLAR *NCC-8609 | |
| LICHTENHAHN *NCC-8613 | |
| MEANS *NCC-8628 | |
| NEILL *NCC-8618 | |
| QUEDA *NCC-8626 | |

*CLASS SHIP. **LOST IN THE LINE OF DUTY. ***PROPOSED. ALL NAMES PRECEDED WITH "U.S.S."

Tractor Beam Specifications

Primary Tractor Beam Load Calculator

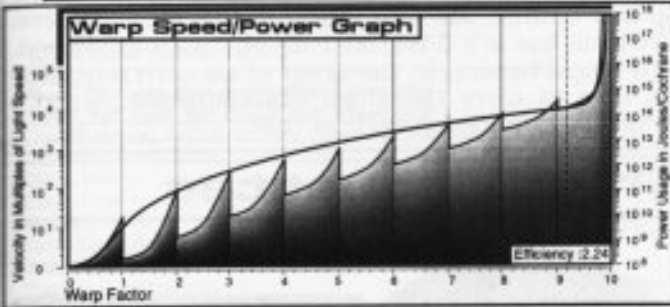
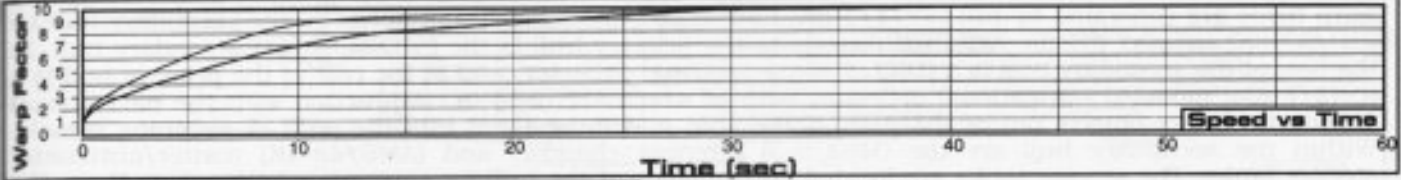
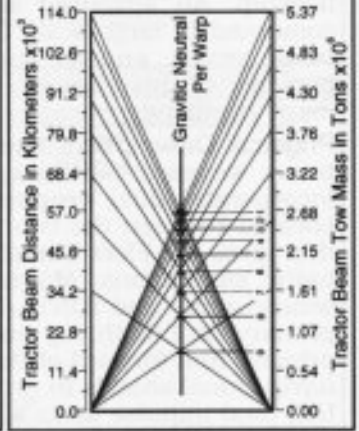

Field Length 671.10m
Field Width 232.00m
Field Height 114.40m

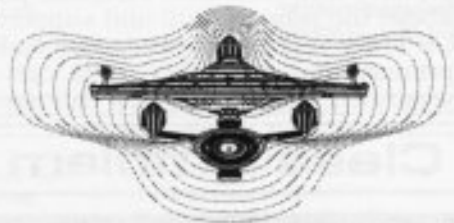

Front Warp Field Profile
Cross Section Area 18545.12 m²

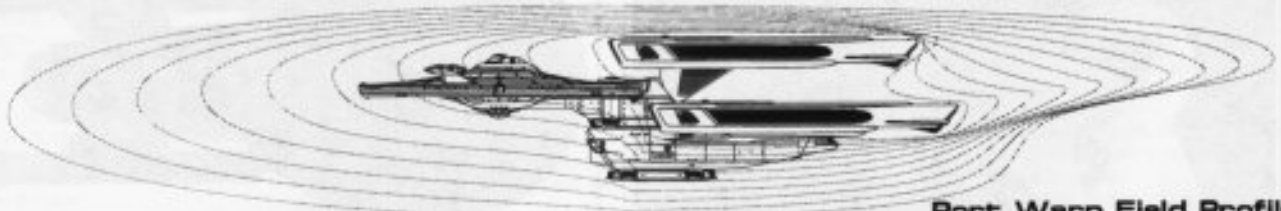

Port Warp Field Profile
Cross Section Area 58859.92 m²

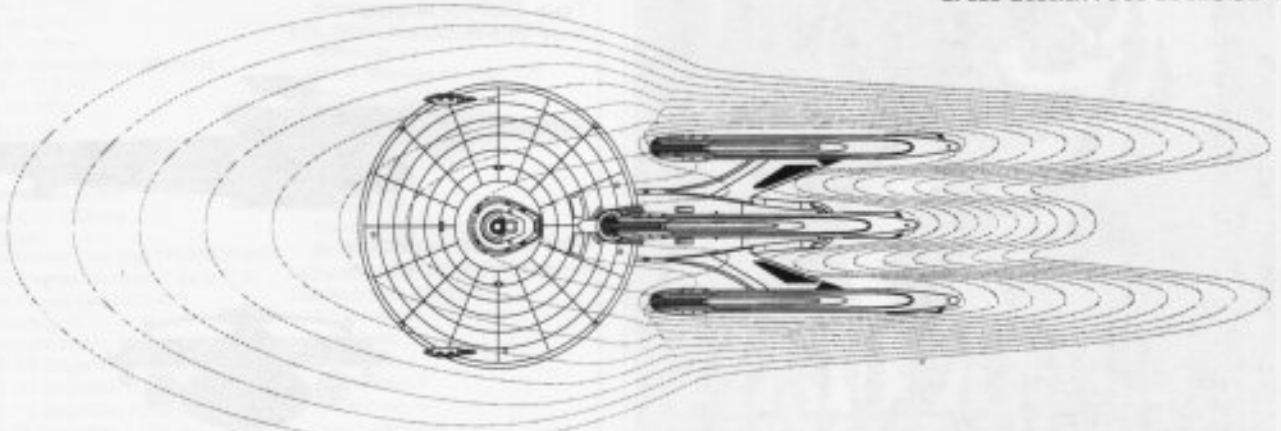

Top Warp Field Profile
Cross Section Area 103001.84 m²

WARP FIELDS

SRM2 04:02:02:04

FIRESTONE CLASS

FEDERATION VESSEL

BATTLESHIP



KODIAK CLASS

General Information

Specific Role: The Battleship's primary military role is as a capital assault ship and as a command flagship. An advanced strategic bridge on the Battleship provides a comprehensive platform for the command of large scale fleet operations. The Battleship is one of the Federation's most powerful main-battle vessel, and as such its role throughout any theater is predominantly military. The formidable presence of this class of capital vessels has insured the signing of many treaties and peaceful outcome to many conflicts.

Physical Description: The Battleship's (PHE147/A-A4) extended primary hull is equipped with extremely heavy weapons, shielding, and ECM/ECCM devices; as well as a (BS12/A-S4) strategic bridge which incorporates dual weapons stations and an additional tracking station and a multitiered command level. Located between the two tiers on the bridge is the (HBD01/HUD-02) holographic battle-field display unit that gives the Fleet Commander immediate updates on combat developments and can also be used to run battle simulations. Mounted on the underside of the primary hull are the integrated (SM49/4J) main sensor array and (DNT4/5-X) navigation/tracking dome. Located on the port, starboard and bow of the primary hull (both top and bottom) are six (BP2/30-2C) phaser banks. Port and starboard on the upper primary hull forward of the raised extension, are the (DN2/G-4.2) navigational deflectors used to assist the navigational shields in deflecting oncoming debris. Mounted on the rear of the primary hull are (IP186E/7-UH) dual impulse units which are used for auxiliary power and sub-warp propulsion. Two medium hangar decks are installed, one on either side of the impulse engines, in the rear of the primary hull. The vessel's warp fields are generated by two (SY71/1-5AC) advanced warp nacelles attached to the secondary hull by (DU/37-8K) support pylons. Attached directly to the primary hull is the (SH221/A-M1) secondary hull. In the bow of the secondary hull is a (DN2/F-6) navigational deflector, and at the rear of the primary hull is a (DN2/F-6M) modified navigational deflector; both of which are used in conjunction with the navigational shields to deflect objects out of the path of the ship and move them into the path of pursuing vessels. Within the secondary hull are the (M62/9-3) intermix chamber and (AM8/48-4K) matter/antimatter storage tanks. The storage tanks are located on the spine of the hull for emergency jettisoning. Above the primary hull extension mounted port and starboard, top and bottom, are four (MP2/15-2G) MegaPhasers. Above the primary hull and supported by the (DU/52-12W) roll bar is a (PB4/50-10E) photon torpedo pod. On lower rear of the secondary hull are two (MP2/15-2G) MegaPhasers. In the event of an emergency the primary and secondary hulls can separate; each being able to carry the ships full complement. Once separated, the primary hull can maneuver on impulse power for extended periods of time.

Class Emblem

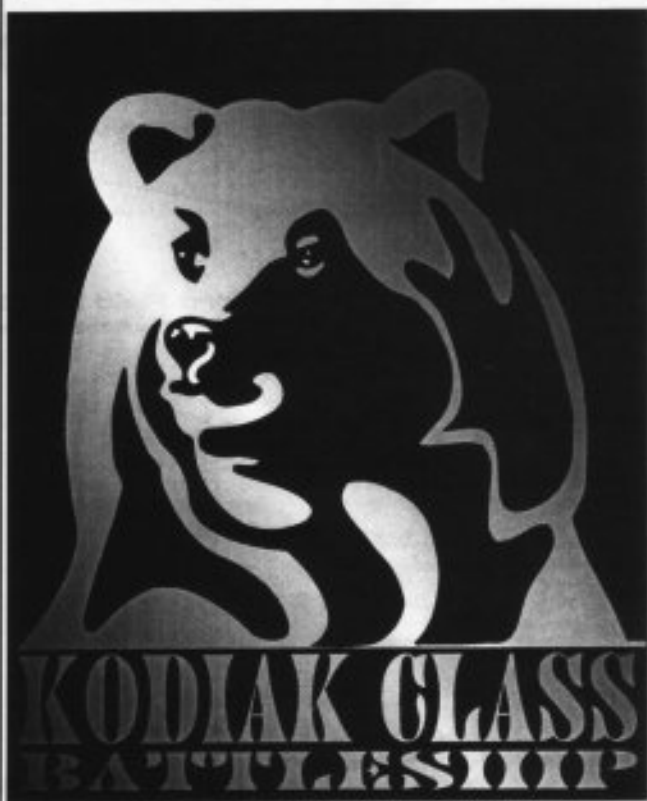

Ship Silhouettes

Total Target Area 52097.98 m²



Top Silhouette

Area 35941.32 m²



Port Silhouette

Area 10883.72 m²



Front Silhouette

Area 5472.92 m²

FEDERATION VESSEL



BATTLESHIP

KODIAK CLASS

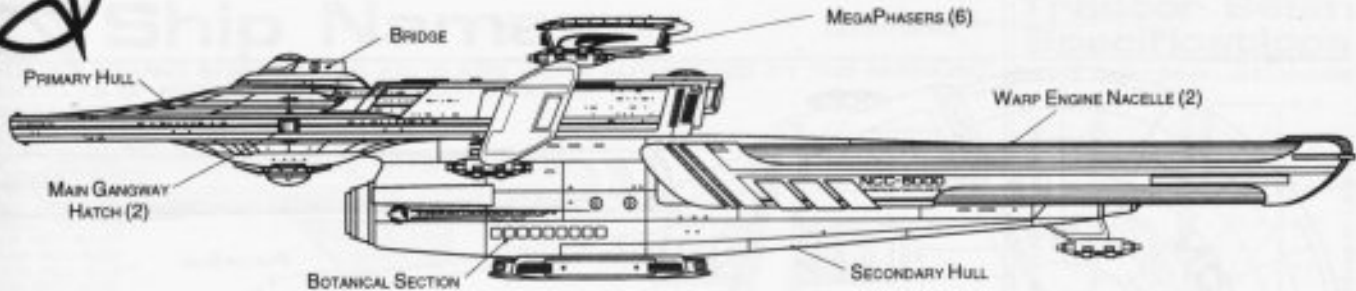

PORT PROFILE

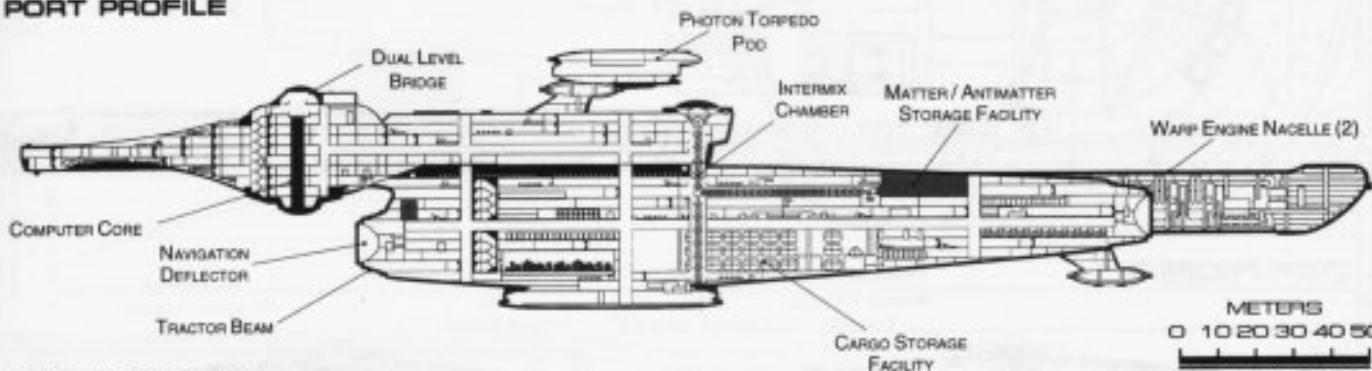

METERS
0 10 20 30 40 50
SCALE 1:2000

CROSS SECTION

Statistics

Classification: Battleship

Category: Assault Ship

Class: Kodiac

Type: Class 1

Model: MK-XXI

Naval Construction Contract: 6000

Number Proposed: 20

Number Constructed: 18

Number in Service: 15

Number Lost: 2

Dimensions:

Overall Dimensions (Meters)

Length: 338.45m

Width: 141.72m

Height: 65.36m

Primary Hull Dimensions (Meters)

Length: 179.10m

Width: 141.72m

Height: 32.94m

Secondary Hull Dimensions (Meters)

Length: 210.14m

Width: 66.37m

Height: 31.59m

Warp Unit Dimensions (Meters)

Length: 177.51m

Width: 26.84m

Height: 17.66m

Displacement (Metric Tons)

Light: 432,826mt

Standard: 463,724mt

Full Load: 517,664mt

Performance:

Impulse Units: Dual Unit (IP186E/7-UH)

Impulse Engine Output: 7.8×10^{13} W

Impulse Power Index: 0.430

Max Cruising: C

Acceleration Rate:

0.00-0.25 Impulse: 0.469 sec.

0.25-0.50 Impulse: 0.704 sec.

0.50-0.75 Impulse: 0.939 sec.

0.75-Full Impulse: 1.174 sec.

Warp Units: 2 Nacelle Units (SY71/1-SAC)

Warp Engine Output: 2.16×10^{15} W

Warp Power Index: 0.77

Optimum Speed: Warp 4

Max. Safe Cruising: Warp 6

Emergency Speed: Warp 8

Max. Speed: Warp 9.05

Destructive Speed: Warp 9.2

Acceleration Power: 3.0

Acceleration Times:

Warp 1 - Warp 2: 0.261 sec.

Warp 2 - Warp 3: 0.417 sec.

Warp 3 - Warp 4: 1.578 sec.

Warp 4 - Warp 5: 2.269 sec.

Warp 5 - Warp 6: 2.426 sec.

Warp 6 - Warp 7: 2.621 sec.

Warp 7 - Warp 8: 3.365 sec.

Warp 8 - Warp 9: 4.812 sec.

Warp 9 - Warp 9.5: 10.694 sec.

Warp 9.5 - Warp 9.75: 12.389 sec.

Warp 9.75 - Warp 9.9: 25.692 sec.

Duration (Years)

Standard: 6 Years

Maximum: 24 Years

Std. Ships Complement: 700

Officers: 107

Crew (Ensign Grade): 523

Troops: 70

Passengers: 94

Emergency condition: +920

Medical Facilities:

Doctors: 8

Nurses: 42

Operating Rooms: 6

Beds: 42

Laboratories: 14

Transporters Total: 24

1 Person: 0

2 Person: 0

6 Person: 8

12 Person: 0

22 Person: 8

Small Cargo: 4

Medium Cargo: 4

Large Cargo: 0

Super Cargo: 0

Brigs: 57

Replicators: 35

Tractor Beams: 1

Tow Capacity: 6.76×10^6 mt

Max Range: 1.20×10^5 km

Cargo Specification:

Standard Cargo Units: 1045

Cargo Capacity: 52,250mt

Shuttlecraft Specifications:

Docking Ports: 7

Shuttlecraft Bays Total: 2

Small Bay: 0

Medium Bay: 2

Large Bay: 0

Super Bay: 0

Shuttlecraft Standard: 58

Work Bees: 3

Travel Pods: 3

Aquatic Shuttle: 1

Light Shuttle: 2

Standard Shuttle: 12

Heavy Shuttle: 2

Cargo Shuttle: 2

Assault Shuttle: 9

Killer Bees: 7

Fighter: 10

Heavy Fighter: 7

Lifeboats: 71

Turbolift (8 person): 23

Lifeboat (10 person): 33

Lifeboat (20 person): 14

Lifeboat (30 person): 1

Cloaking Devices: 1

Sensor Index Values:

Planetary Survey: 0.8680

Stellar Survey: 0.6986

Short Range: 1.2718

Long Range: 1.0236

Navigation: 1.2429

Special: 1.4690

Computers: 2

Type: Daystrom Duotronic III:0

Type: Daystrom Duotronic II:q

ECM Index: 1.35/2.80

Shield Rating:

Shield Index: 0.65

Holdoff Power: 4.91×10^{12} W

Refresh Rate: 1.40×10^{12} W

Breakdown Rate: 1.67×10^{12} W

Shield Dimensions (Meters)

Length: 427.52m

Width: 177.01m

Height: 82.56m

Weapons:

Phaser Power Index: 1.21

Photon Power Index: 13.63

Vessel Power Index: 7.42

Weapon Placement:

Beam (Phasers) Total: 10 banks 2 each

Output: 5.0×10^{11} W / 2.5×10^{11} W

Range: 2.5×10^5 km

Rate of Fire: 30 ppm / Cont.

Forward Banks: 2

Rear Banks: 1

Port Banks: 2

Starboard Banks: 2

Upper Banks: 1

Lower Banks: 2

Beam (MegaPhasers) Total: 6

Output: 2.6×10^{12} W / 1.3×10^{12} W

Range: 1.0×10^5 km

Rate of Fire: 15 ppm / Cont.

Forward/Rear Banks: 2

Port/Starboard Banks: 0

Upper/Lower Banks: 4

Torpedoes (Photon) Total: 5 Bay 2 each

Stock: 250

Range: 2.0×10^5 km

Output: 10-50 Megatons

Rate of Fire: 10 spm

Forward Bay: 3

Rear Bay: 2

Port Bay: 0

Starboard Bay: 0

Upper Bay: 0

Lower Bay: 0

FEDERATION VESSEL

BATTLESHIP



KODIAK CLASS

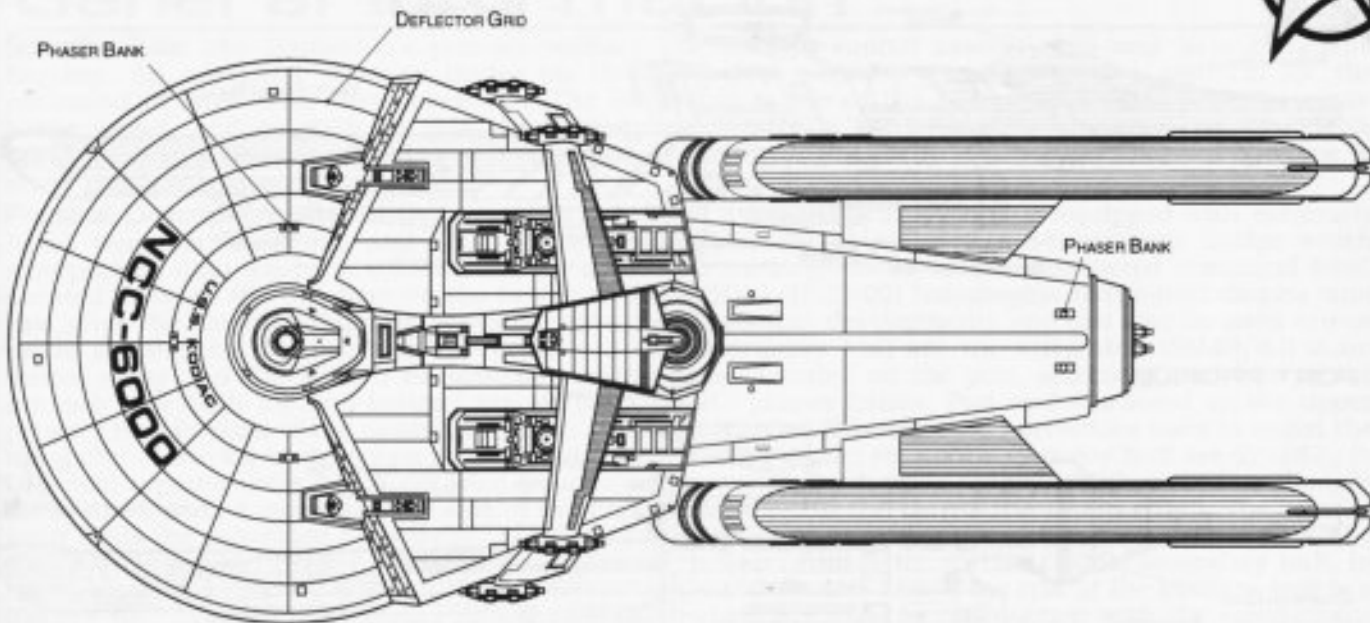

TOP PROFILE

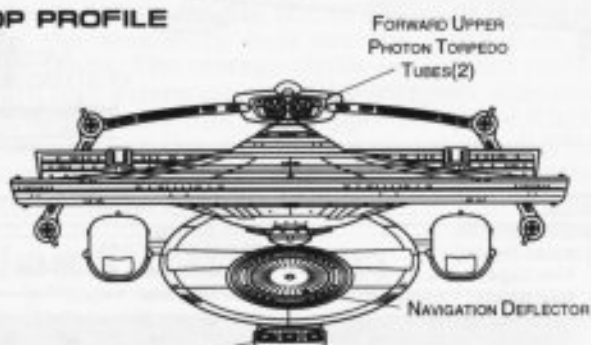

FRONT PROFILE

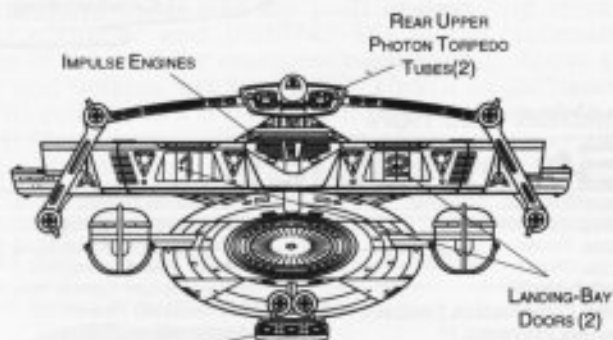

REAR PROFILE

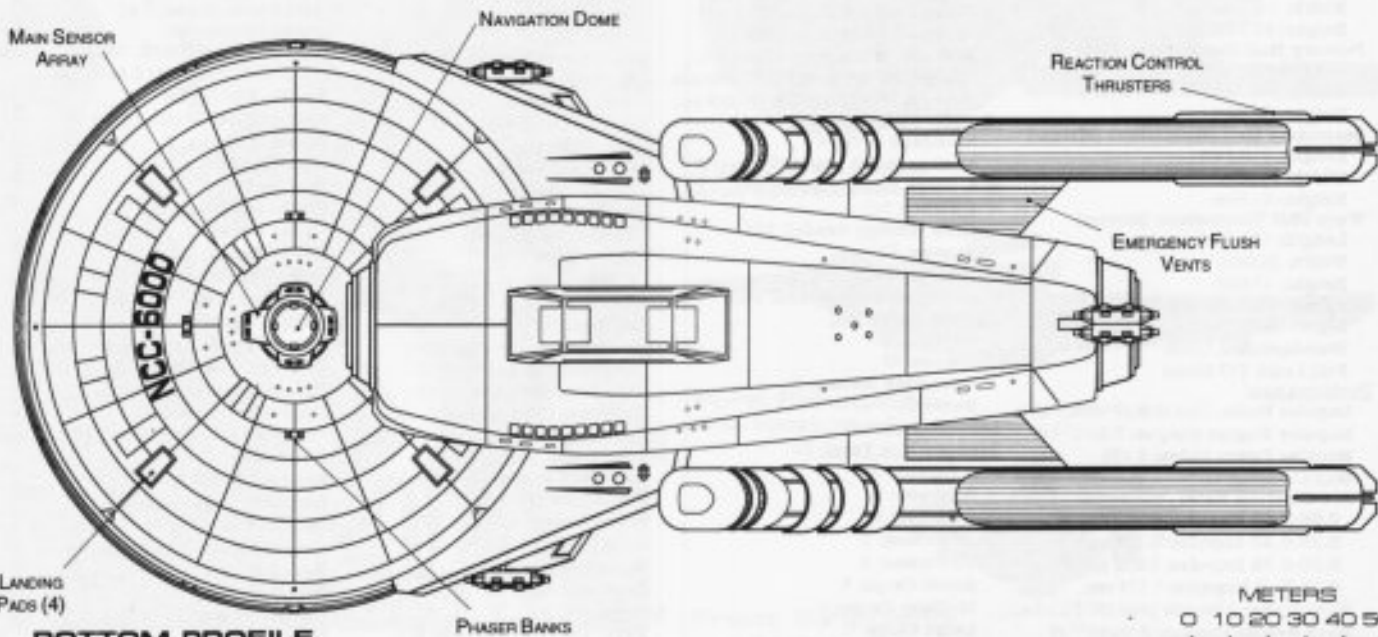

BOTTOM PROFILE

METERS
0 10 20 30 40 50
SCALE 1:2000

FEDERATION VESSEL



BATTLESHIP

Ship Names

THE FOLLOWING SHIPS OF THE XXI CLASS WERE AUTHORIZED BY THE AMENDED ARTICLES OF FEDERATION OF STARDATE 2273.2

- ARRINGTON *NCC-8009
- DEAVOURS *NCC-8014
- ELLSWORTH *NCC-8006
- FENTER *NCC-8002
- GOLSON *NCC-8019***
- MUDNALL *NCC-8003
- ELSENG *NCC-8001
- JOSSELET *NCC-8017
- KELCH *NCC-8012**
- KODIAK *NCC-8000*
- LEATON *NCC-8018***
- MASON *NCC-8016
- NATIONS *NCC-8007
- OVERBY *NCC-8004
- PAYNE *NCC-8008**
- QUINTANILLA *NCC-8015
- ROREX *NCC-8005
- SINCLAIR *NCC-8013
- TOENSKOETTER *NCC-8011
- VARGAS *NCC-8010

*CLASS SHIP, **LOST IN THE LINE OF DUTY, ***PROPOSED. ALL NAMES PRECEDED WITH "U.S.S."

Tractor Beam Specifications

Primary Tractor Beam Load Calculator

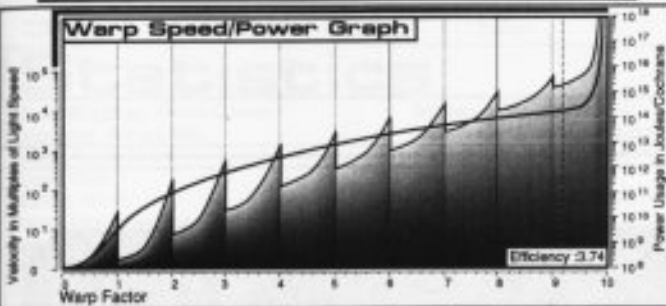
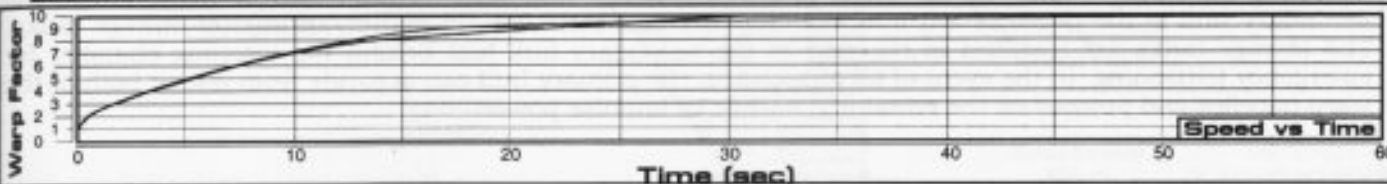
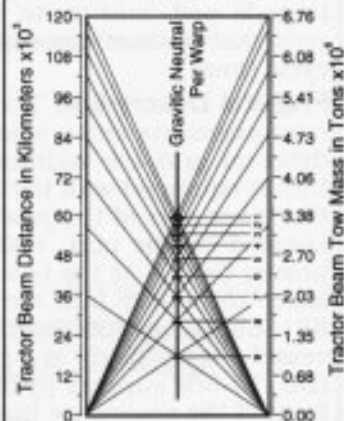

Field Length 715.51m
 Field Width 228.83m
 Field Height 112.20m

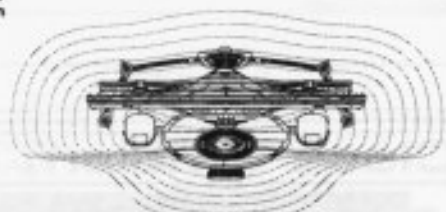

Front Warp Field Profile
 Cross Section Area 18152.24 m²

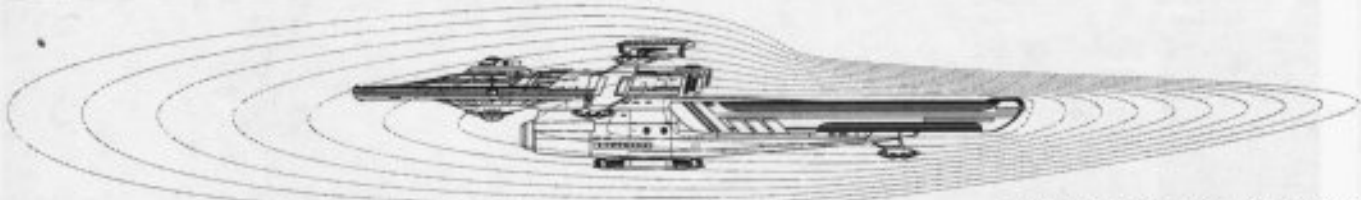

Port Warp Field Profile
 Cross Section Area 52287.80 m²

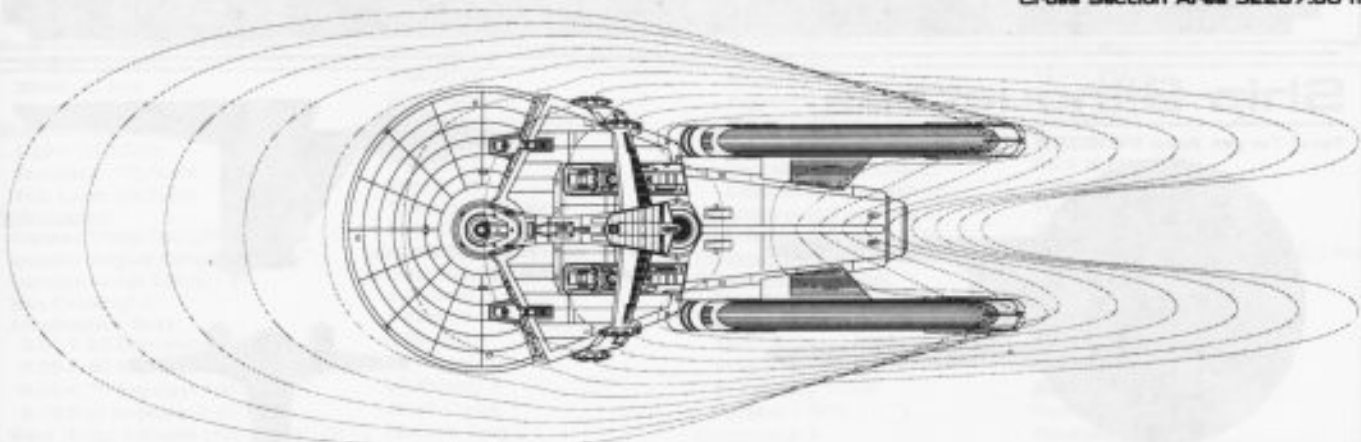

Top Warp Field Profile
 Cross Section Area 118026.98 m²

WARP FIELDS

ESCORT CRUISER



General Information

Specific Role: The Escort Cruiser's major strength comes from its turret mounted rapid firing photon torpedo pod, and in its role as convoy escort it can lay down 360° suppressing and defensive fire in a remarkably short amount of time (due to the photon torpedoes' direct path to the target and quick tube cycle time).

Physical Description: The (PH147/A-M4) primary hull is equipped with additional targeting sensors, hull reinforcements and a small hangar deck (located on the upper starboard side). Integrated into the standard deflector grid are additional electronic counter-measures to make the vessel more stealthy. The primary hull is equipped with the (BS10/A-T3) bridge which incorporates a larger weapons and tracking station. On the lower part of the primary hull is the (SM49/12K) main sensor array and (DN4/9P) navigational dome. Located on the port, starboard and bow of the primary hull (both top and bottom) are six (BP2/30-2C) phaser banks. At the base of the secondary hull is the turreted (TPB2/25-20G) photon torpedo pod. On the lower secondary hull are four additional (BP2/30-2C) phaser banks. To the rear of the primary hull are (IP186E/E-IU) dual impulse units, which are used for auxiliary power and sub-warp propulsion. The vessel's warp fields are generated by two (SW52/1-5WE) warp nacelles attached to the primary hull by (DU/15-6B) support pylons. Attached below the primary hull is the (SH88/A-H8) secondary hull. On the front of the secondary hull is the (DN2/D-7) navigational deflector used to assist the navigational shields in deflecting oncoming debris. In the stern of the secondary hull is a medium hangar deck. Inside the secondary hull is the (M25/24-4A) intermix chamber and (AM8/34-4P) matter/antimatter storage tanks. The storage tanks are installed in the rear of the secondary hull just behind the intermix chamber for emergency jettisoning. In the event of an emergency, the primary hull can separate from one or both of the warp nacelles and proceed on the remaining nacelle or impulse power.

Class Emblem



Ship Silhouettes

Total Target Area 34050.80 m²

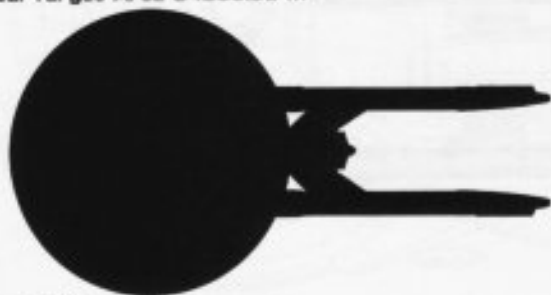

Top Silhouette
Area 22114.92 m²



Port Silhouette
Area 9526.88 m²



Front Silhouette
Area 3409.80 m²



ESCORT CRUISER

MAGUELLANES CLASS

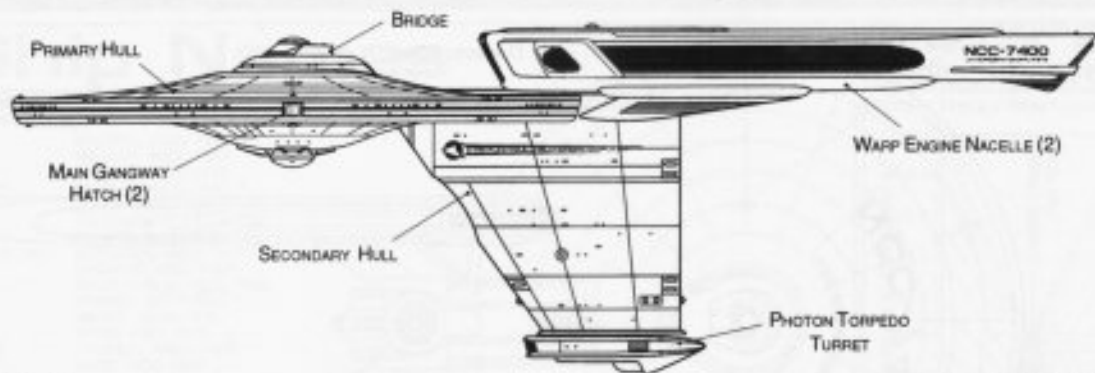

PORT PROFILE

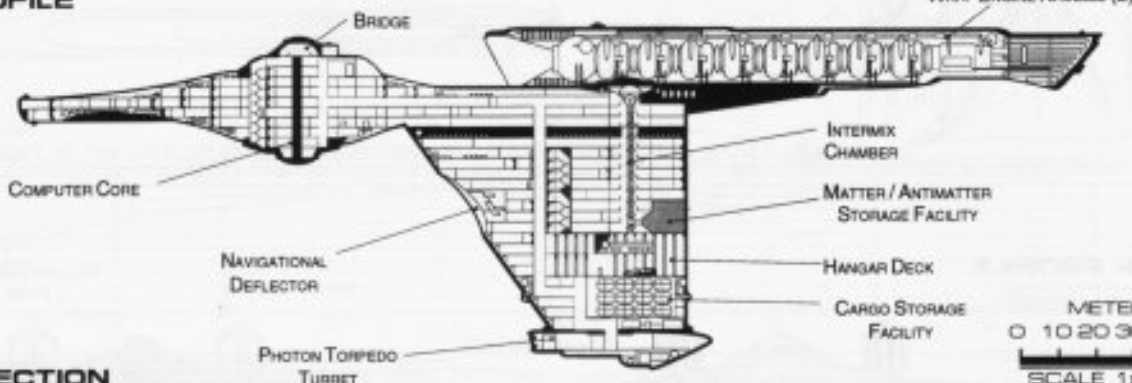

CROSS SECTION



Statistics

Classification: Escort Cruiser
Category: Assault Ship
Class: Maguellanes
Type: Class 1
Model: MK-III
Naval Construction Contract: 7400
Number Proposed: 40
Number Constructed: 35
Number in Service: 35
Number Lost: 0
Dimensions:
Overall Dimensions (Meters)
 Length: 272.36m
 Width: 141.72m
 Height: 87.83m
Primary Hull Dimensions (Meters)
 Length: 146.31m
 Width: 141.72m
 Height: 32.94m
Secondary Hull Dimensions (Meters)
 Length: 83.96m
 Width: 23.12m
 Height: 74.06m
Warp Unit Dimensions (Meters)
 Length: 154.81m
 Width: 12.63m
 Height: 18.32m
Displacement (Metric Tons)
 Light: 166,600mt
 Standard: 178,493mt
 Full Load: 199,355mt
Performance:
Impulse Units: Dual Unit (JP186E/IE-IU)
Impulse Engine Output: 7.8×10^{13} W
Impulse Power Index: 1.11
Max Cruising: C
Acceleration Rate:
 0.00-0.25 Impulse: 0.181 sec.
 0.25-0.50 Impulse: 0.271 sec.
 0.50-0.75 Impulse: 0.361 sec.
 0.75-Full Impulse: 0.452 sec.
Warp Units: 2 Nacelle Units (SW52/1-5WE)
Warp Engine Output: 1.2×10^{15} W
Warp Power Index: 1.110

Optimum Speed: Warp 4
Max. Safe Cruising: Warp 6
Emergency Speed: Warp 7.9
Max. Speed: Warp 8.7
Destructive Speed: Warp 9.05
Acceleration Power: 3.0
Acceleration Times:
 Warp 1 - Warp 2: 0.181 sec.
 Warp 2 - Warp 3: 0.299 sec.
 Warp 3 - Warp 4: 1.093 sec.
 Warp 4 - Warp 5: 1.572 sec.
 Warp 5 - Warp 6: 1.681 sec.
 Warp 6 - Warp 7: 1.816 sec.
 Warp 7 - Warp 8: 2.331 sec.
 Warp 8 - Warp 9: 3.334 sec.
 Warp 9 - Warp 9.5: 7.409 sec.
 Warp 9.5 - Warp 9.75: 8.584 sec.
 Warp 9.75 - Warp 9.9: 17.800 sec.

Duration (Years)
 Standard: 5 Years
 Maximum: 20 Years
Std. Ships Complement: 411
 Officers: 66
 Crew (Ensign Grade): 320
 Troops: 25
 Passengers: 40
 Emergency condition: +541

Medical Facilities:
 Doctors: 5
 Nurses: 26
 Operating Rooms: 4
 Beds: 26
Laboratories: 5
Transporters Total: 10
 1 Person: 0
 2 Person: 0
 6 Person: 4
 12 Person: 0
 22 Person: 4
 Small Cargo: 1
 Medium Cargo: 1
 Large Cargo: 0
 Super Cargo: 0

Brigs: 13
Replicators: 14
Tractor Beams: 1
 Tow Capacity: 3.87×10^6 mt
 Max Range: 1.16×10^6 km
Cargo Specification:
 Standard Cargo Units: 257
 Cargo Capacity: 12,850mt
Shuttlecraft Specifications:
 Docking Ports: 3
Shuttlecraft Bays Total: 1
 Small Bay: 0
 Medium Bay: 1
 Large Bay: 0
 Super Bay: 0
Shuttlecraft Standard: 29
 Work Bees: 1
 Travel Pods: 2
 Aquatic Shuttle: 1
 Light Shuttle: 1
 Standard Shuttle: 6
 Heavy Shuttle: 1
 Cargo Shuttle: 1
 Assault Shuttle: 3
 Killer Bees: 4
 Fighter: 5
 Heavy Fighter: 4
 Lifeboats: 43
 Turbolift (8 person): 22
 Lifeboat (10 person): 15
 Lifeboat (20 person): 6
 Lifeboat (30 person): 0

Cloaking Devices: 0
Sensor Index Values:
 Planetary Survey: 0.7317
 Stellar Survey: 0.7318
 Short Range: 1.2965
 Long Range: 1.2341
 Navigation: 1.0430
 Special: 1.0120
Computers: 2
 Type: Daystrom Duotronic III:n
 Type: Daystrom Duotronic II:n

ECM Index: 1.12
Shield Rating:
Shield Index: 1.14
Holdoff Power: 3.33×10^{12} W
Refresh Rate: 9.46×10^{11} W
Breakdown Rate: 1.13×10^{12} W
Shield Dimensions (Meters)
 Length: 344.04m
 Width: 177.01m
 Height: 110.82m
Weapons:
Phaser Power Index: 1.20
Photon Power Index: 8.85
Vessel Power Index: 4.73
Weapon Placement:
Beam (Phasers) Total: 10 banks 2 each
 Output: 5.0×10^{11} W / 2.5×10^{11} W
 Range: 2.5×10^5 km
 Rate of Fire: 30 ppm / Cont.
Forward Banks: 3
Rear Banks: 1
Port Banks: 2
Starboard Banks: 4
Upper Banks: 0
Lower Banks: 0
Beam (MegaPhasers) Total: 0
 Output: N/A
 Range: N/A
 Rate of Fire: N/A
Forward/Rear Banks: 0
Port/Starboard Banks: 0
Upper/Lower Banks: 0
Torpedoes (Photon) Total: 1 Bay 2 each
 Stock: 100
 Range: 2.0×10^5 km
 Output: 10-50 Megatons
 Rate of Fire: 20 apm
Forward Bay: 2
Rear Bay: 0
Port Bay: 0
Starboard Bay: 0
Upper Bay: 0
Lower Bay: 0

FEDERATION VESSEL

ESCORT CRUISER



MAGUELLANES CLASS

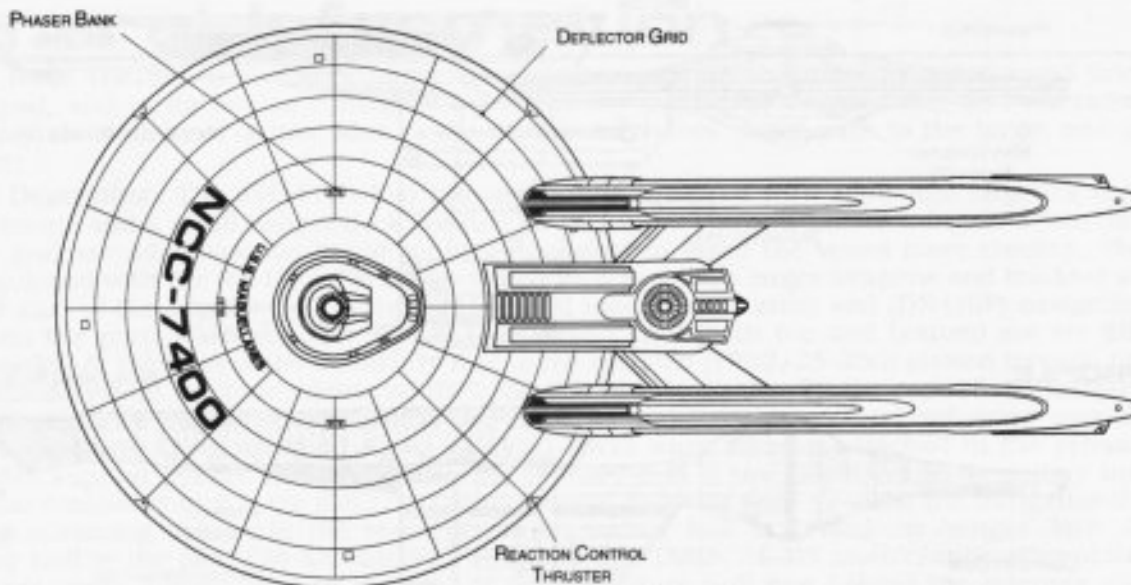

TOP PROFILE

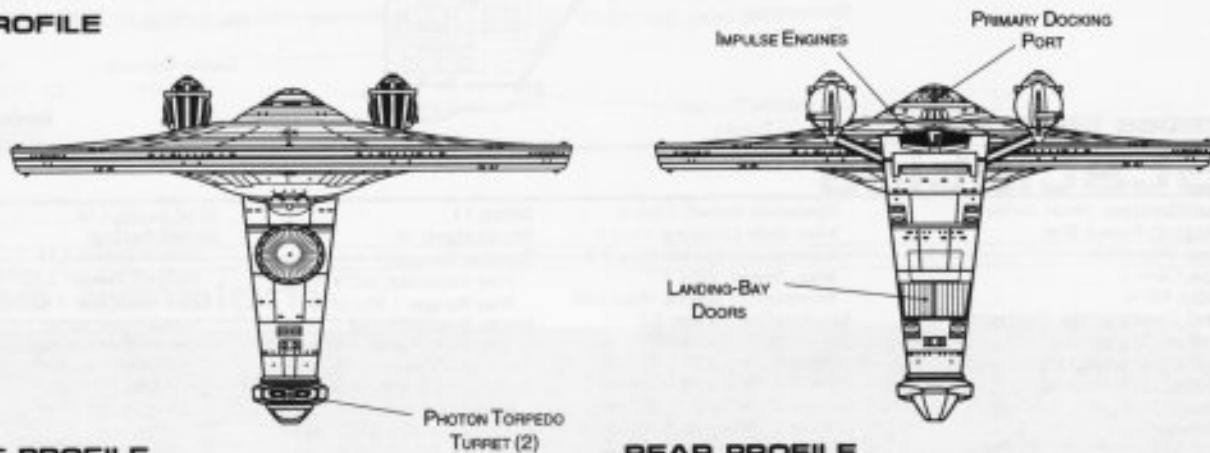

FRONT PROFILE

REAR PROFILE

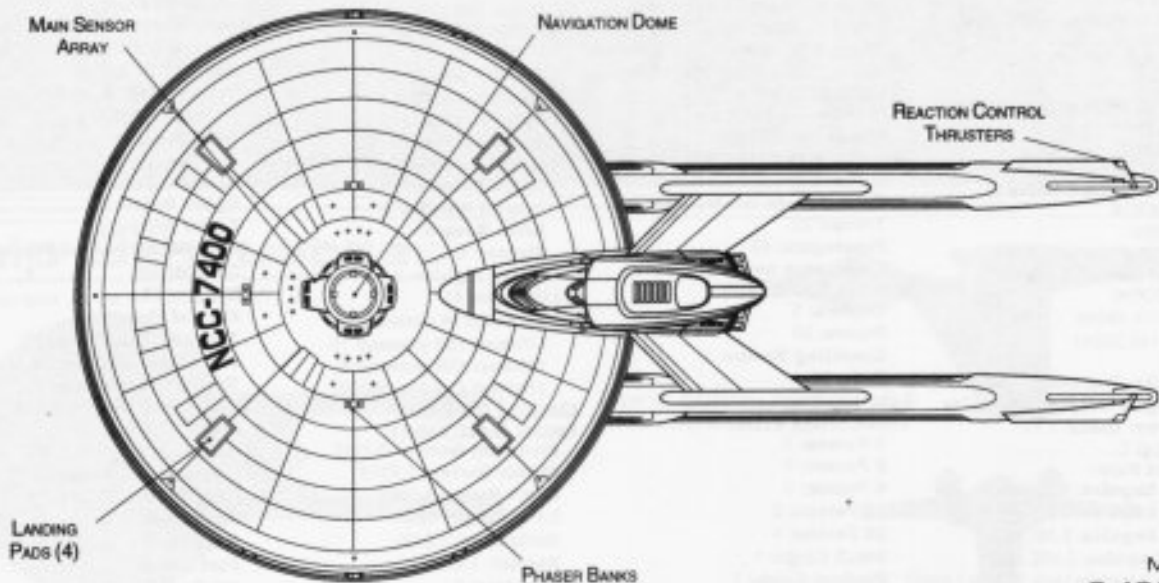

BOTTOM PROFILE

METERS
0 10 20 30 40 50
SCALE 1:2000

FEDERATION VESSEL



ESCORT CRUISER

Ship Names

THE FOLLOWING SHIPS OF THE MK-III CLASS WERE AUTHORIZED BY THE AMENDED ARTICLES OF FEDERATION OF STARDATE 2274.2

- | | |
|-------------------------|-----------------------|
| ALLEN *NCC-7404 | MASTKE *NCC-7415 |
| ARTHUR *NCC-7414 | MEZACK *NCC-7422 |
| BEAKLEY *NCC-7434 | NEWELL *NCC-7419 |
| BRANSON *NCC-7435*** | NICCOM *NCC-7437*** |
| CLASON *NCC-7425 | OGAN *NCC-7401 |
| CLAYTON *NCC-7416 | PENDGRAFT *NCC-7418 |
| DAWKINS *NCC-7427 | QUANT *NCC-7430 |
| DEMULEMEESTER *NCC-7407 | RICHARDS *NCC-7438*** |
| EDMONDS *NCC-7431 | SHAWGO *NCC-7405 |
| ELLERD *NCC-7406 | THORVILSON *NCC-7424 |
| FLEMENS *NCC-7439*** | UNREIN *NCC-7436*** |
| FORDE *NCC-7423 | VARDY *NCC-7412 |
| GILDER *NCC-7410 | WEBB *NCC-7402 |
| GLEGHORN *NCC-7432 | YANDELL *NCC-7426 |
| HATHORN *NCC-7408 | ZAIDI *NCC-7409 |
| HEROD *NCC-7428 | |
| ICKLES *NCC-7429 | |
| INFANTE *NCC-7417 | |
| JONISH *NCC-7421 | |
| JORGE *NCC-7433 | |
| KIRKSEY *NCC-7411 | |
| KNIER *NCC-7403 | |
| LEMOINE *NCC-7420 | |
| LESTER *NCC-7413 | |
| MAGUELLANES *NCC-7400* | |

*CLASS SHIP, **LOST IN THE LINE OF DUTY, ***PROPOSED, ALL NAMES PRECEDED WITH "U.S.S."

Tractor Beam Specifications

Primary Tractor Beam Load Calculator

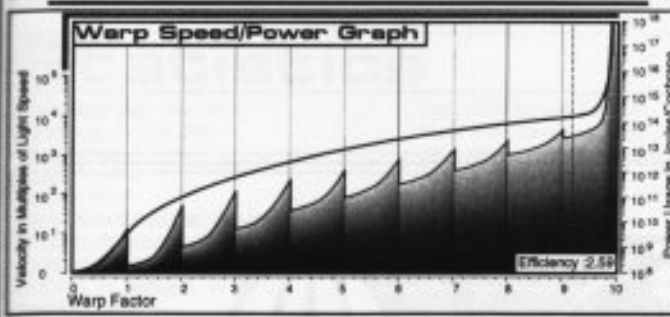
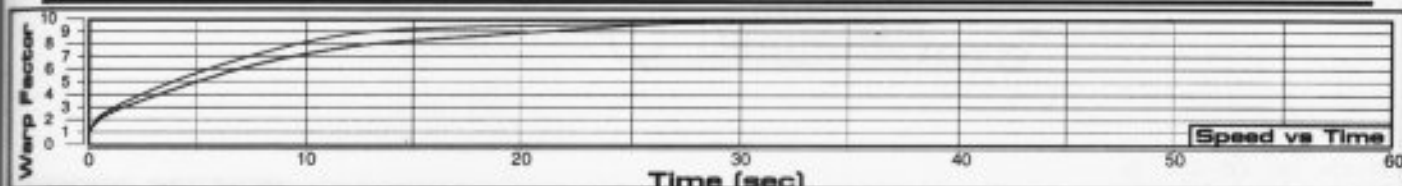
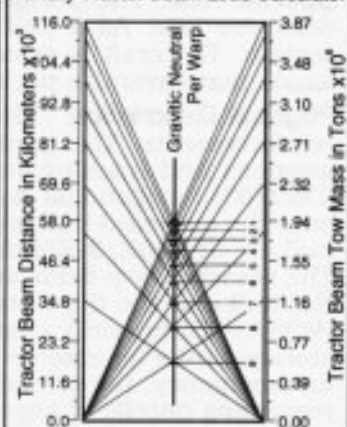

Field Length 803.32m
Field Width 210.83m
Field Height 112.20m

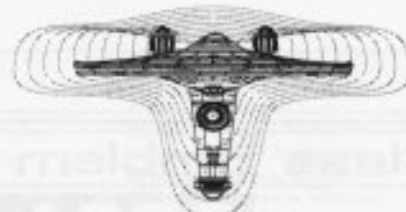

Front Warp Field Profile
Cross Section Area 11346.08 m²



Port Warp Field Profile
Cross Section Area 41270.72 m²

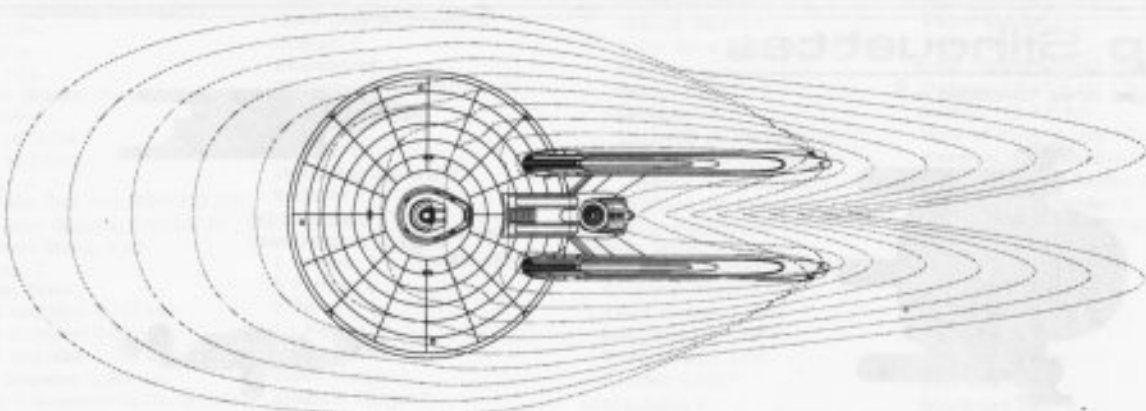

Top Warp Field Profile
Cross Section Area 89759.28 m²

WARP FIELDS

SRM2 04:02:04:04

STARFLEET REFERENCE MANUAL

MAGUELLANES CLASS

FEDERATION VESSEL

GUNBOAT



ORCA CLASS

General Information

Specific Role: The Gunboat is a high maneuverability, in-system warp capable ship primarily used in a defensive role. As a cost saving measure the hull is a modified Oberth Class research vessel upper section. The craft is armed with dual mega-phasers making it a powerful weapons platform in a very small, maneuverable package.

Physical Description: The (SH103/A-T6) ship is equipped with additional targeting sensors and hull reinforcements. The gunboat is equipped with a (BF5/A-C5) bridge which incorporates an enhanced weapons and tracking station. On the lower part of the hull is the (SM15/3J) main sensor array and (DN2/6T) navigational dome. Positioned forward of the bridge is a (BP2/30-2C) phaser bank. Mounted onto the outboard hull on the forward nacelles are (MP2/15-2G) MegaPhasers. At the rear of the primary hull are (ISR10E/2-ER) dual impulse units which are used for auxiliary power and sub-warp propulsion. The vessel's warp fields are generated by three (SU38/1-2DT) warp nacelles two attached to each side of the hull and the third attached below the hull. Running horizontally between the upper nacelles is the (M36/3-2B) intermix chamber. Installed to the rear of the hull are the (AM3/24-2P) matter/antimatter storage tanks for emergency jettisoning. On the front of the hull is a small hangar deck. In the event of an emergency, the primary hull can separate from one or more of the warp nacelles and proceed on the remaining nacelle or impulse power.

Class Emblem

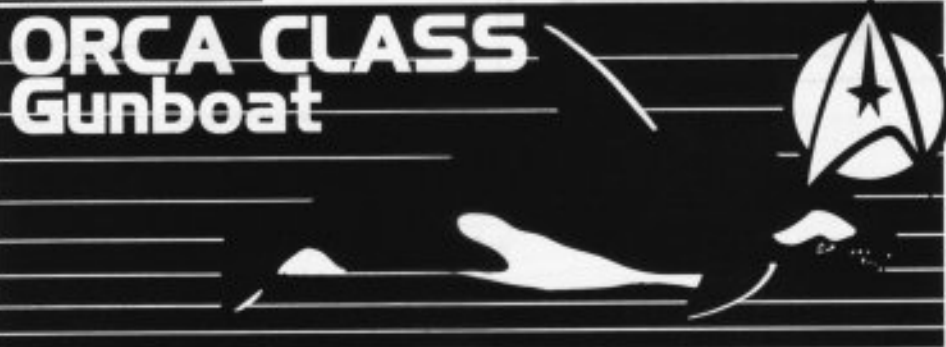

Ship Silhouettes

Total Target Area 10498.00 m²



Top Silhouette
Area 7188.8 m²



Port Silhouette
Area 2100.40 m²



Front Silhouette
Area 1208.80 m²

FEDERATION VESSEL

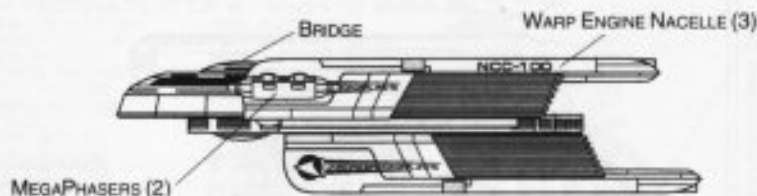

PORT PROFILE

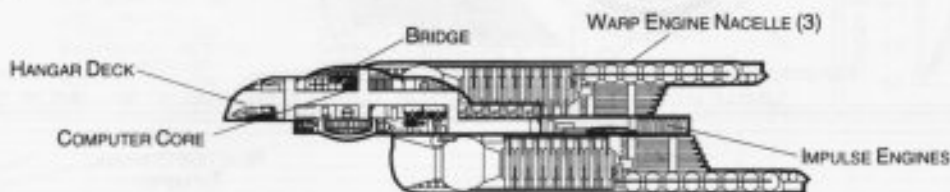

CROSS SECTION



Statistics

Classification: Gun Boat

Category: Assault Ship

Class: Orca

Type: Class 2

Model: MK-II

Naval Construction Contract: 100

Number Proposed: 87

Number Constructed: 85

Number in Service: 80

Number Lost: 5

Dimensions:

Overall Dimensions (Meters)

Length: 115.98m

Width: 102.22m

Height: 26.31m

Primary Hull Dimensions (Meters)

Length: 92.73m

Width: 82.97m

Height: 15.22m

Secondary Hull Dimensions (Meters)

Length: N/A

Width: N/A

Height: N/A

Warp Unit Dimensions (Meters)

Length: 83.09m

Width: 10.85m

Height: 12.17m

Displacement (Metric Tons)

Light: 33,962mt

Standard: 36,387mt

Full Load: 40,619mt

Performance:

Impulse Units: Dual Unit (ISR10E/2-ER)

Impulse Engine Output: 6.0×10^{13} W

Impulse Power Index: 5.43

Max Cruising: C

Acceleration Rate:

0.00-0.25 Impulse: 0.147 sec.

0.25-0.50 Impulse: 0.221 sec.

0.50-0.75 Impulse: 0.295 sec.

0.75-Full Impulse: 0.368 sec.

Warp Units: 3 Nacelle Units (SU38/1-2DT)

Warp Engine Output: 2.88×10^{14} W

Warp Power Index: 1.30

Optimum Speed: Warp 4

Max. Safe Cruising: Warp 6

Emergency Speed: Warp 8.1

Max. Speed: Warp 8.8

Destructive Speed: Warp 9.2

Acceleration Power: 3.0

Acceleration Times:

Warp 1 - Warp 2: 0.153 sec.

Warp 2 - Warp 3: 0.246 sec.

Warp 3 - Warp 4: 0.929 sec.

Warp 4 - Warp 5: 1.345 sec.

Warp 5 - Warp 6: 1.428 sec.

Warp 6 - Warp 7: 1.543 sec.

Warp 7 - Warp 8: 1.980 sec.

Warp 8 - Warp 9: 2.832 sec.

Warp 9 - Warp 9.5: 6.293 sec.

Warp 9.5 - Warp 9.75: 7.291 sec.

Warp 9.75 - Warp 9.9: 15.119 sec.

Duration (Years)

Standard: 3 Years

Maximum: 12 Years

Std. Ships Complement: 75

Officers: 12

Crew (Ensign Grade): 57

Troops: 6

Passengers: 3

Emergency condition: +92

Medical Facilities:

Doctors: 2

Nurses: 11

Operating Rooms: 2

Beds: 11

Laboratories: 1

Transporters Total: 2

1 Person: 0

2 Person: 0

6 Person: 1

12 Person: 0

22 Person: 1

Small Cargo: 0

Medium Cargo: 0

Large Cargo: 0

Super Cargo: 0

Brigs: 5

Replicators: 5

Tractor Beams: 1

Tow Capacity: 1.20×10^6 mt

Max Range: 9.83×10^4 km

Cargo Specifications:

Standard Cargo Units: 38

Cargo Capacity: 1,900mt

Shuttlecraft Specifications:

Docking Ports: 1

Shuttlecraft Bays Total: 1

Small Bay: 1

Medium Bay: 0

Large Bay: 0

Super Bay: 0

Shuttlecraft Standard: 9

Work Bees: 1

Travel Pods: 0

Aquatic Shuttle: 0

Light Shuttle: 1

Standard Shuttle: 2

Heavy Shuttle: 0

Cargo Shuttle: 1

Assault Shuttle: 2

Killer Bees: 1

Fighter: 1

Heavy Fighter: 0

Lifeboats: 11

Turbolift (8 person): 10

Lifeboat (10 person): 0

Lifeboat (20 person): 0

Lifeboat (30 person): 0

Cloaking Devices: 0

Sensor Index Values:

Planetary Survey: 0.6390

Stellar Survey: 0.4826

Short Range: 1.7502

Long Range: 1.328

Navigation: 1.3252

Special: 0.5867

Computers: 2

Type: Daystrom Duotronic II/v

Type: Daystrom Duotronic II/v

ECM Index: 1.01

Shield Rating:

Shield Index: 4.66

Holdoff Power: 2.78×10^{12} W

Refresh Rate: 7.91×10^{11} W

Breakdown Rate: 9.49×10^{12} W

Shield Dimensions (Meters)

Length: 139.18m

Width: 122.66m

Height: 31.57m

Weapons:

Phaser Power Index: 3.74

Photon Power Index: 0

Vessel Power Index: 1.87

Weapon Placement:

Beam (Phasers) Total: 1 banks 2 each

Output: 5.0×10^{11} W / 2.5×10^{11} W

Range: 2.5×10^5 km

Rate of Fire: 30 ppm / Cont.

Forward Banks: 1

Rear Banks: 0

Port Banks: 0

Starboard Banks: 0

Upper Banks: 0

Lower Banks: 0

Beam (MegaPhasers) Total: 2

Output: 2.6×10^{12} W / 1.3×10^{12} W

Range: 1.0×10^6 km

Rate of Fire: 15 ppm / Cont.

Forward/Rear Banks: 0

Port/Starboard Banks: 2

Upper/Lower Banks: 0

Torpedoes (Photon) Total: 0

Stock: N/A

Range: N/A

Output: N/A

Rate of Fire: N/A

Forward Bay: 0

Rear Bay: 0

Port Bay: 0

Starboard Bay: 0

Upper Bay: 0

Lower Bay: 0

GUNBOAT



ORCA CLASS

PHASER BANK

DEFLECTOR GRID

EMERGENCY FLUSH VENTS

REACTION CONTROL THRUSTER

TOP PROFILE

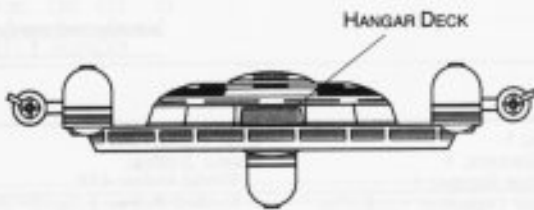

IMPULSE ENGINES



FRONT PROFILE

REAR PROFILE

MAIN SENSOR ARRAY

NAVIGATION DOME

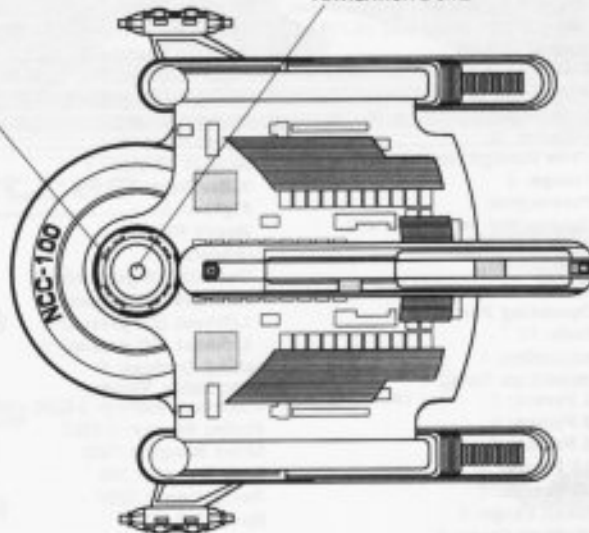

BOTTOM PROFILE

METERS
0 10 20 30 40 50
SCALE 1:1500

FEDERATION VESSEL



GUNBOAT

Ship Names

THE FOLLOWING SHIPS OF THE MK-II CLASS WERE AUTHORIZED BY THE AMENDED ARTICLES OF FEDERATION OF STARDATE 2266.5

ABEL *NCC-101	HERBERGER *NCC-131	NEEL *NCC-123**	UZZLE *NCC-177
BAUMAN *NCC-104	HERMANOS *NCC-140	NORTON *NCC-119	VALLEJO *NCC-174**
BOSTICK *NCC-112	HOLLIDA *NCC-110	NUNNLEY *NCC-109	VARDIMANN *NCC-170
BOYCE *NCC-108	HUESTISES *NCC-158	OAKES *NCC-116	VINTON *NCC-164
BRANCH *NCC-120	INDICOTT *NCC-162	ORKA *NCC-100*	WALLOSH *NCC-154
CHAMBERS *NCC-118	ISENBERG *NCC-149	OWENS *NCC-113	WHALIN *NCC-150
CHARLTON *NCC-125	ISOM *NCC-157	O'CONNOR *NCC-107	WLOWIAK *NCC-159
CHUMLEY *NCC-132	IWANAKA *NCC-163	PACHELLI *NCC-102	YILDIZ *NCC-144
COAKLEY *NCC-139	JACQUES *NCC-168	PEEVEY *NCC-115	YOWEL *NCC-141
DABBS *NCC-146	JAUSHLIN *NCC-176	PUENTE *NCC-121	ZEISSEL *NCC-135
DOLBERRY *NCC-143	JAVIER *NCC-171	QUENEL *NCC-127	ZHAO *NCC-130
DUNNINGAN *NCC-148	JELINK *NCC-183	QUILLIAM *NCC-133	ZUNIGA *NCC-126
DYER *NCC-153	JERGENS *NCC-165	RABUM *NCC-138	
ECKHARDT *NCC-156**	JOHSEN *NCC-180	RODGERS *NCC-142	
EUBANK *NCC-136	KOLEJAR *NCC-186***	RUSHING *NCC-147	
FAIRCHILD *NCC-134	KOLOSIE *NCC-179	SANDEUFFER *NCC-151	
FINCHER *NCC-128	KRISHINAKUMAR *NCC-172	SHAFFERMAN *NCC-155**	
FURMAN *NCC-124	LANNING *NCC-175	SOMMERVILLE *NCC-167	
GALLINGTON *NCC-117	LUERER *NCC-169	STEVIK *NCC-161	
GARRISON *NCC-114	LUEDECKE *NCC-166	SULTAN *NCC-173	
GLUMPLER *NCC-105	LUNA *NCC-160	THELEN *NCC-178	
GOEBEL *NCC-111	LYSAGHT *NCC-152	TIMMONS *NCC-182	
GONZALEZ *NCC-122	MASTROVICH *NCC-145	TYSON *NCC-185***	
GUTIERREZ *NCC-103	MAYNES *NCC-137	UNDERHILL *NCC-184	
HAMBLIN *NCC-106	MCCLEAD *NCC-129	URBANOSKY *NCC-181**	

*CLASS SHIP, **LOST IN THE LINE OF DUTY, ***PROPOSED. ALL NAMES PRECEDED WITH "U.S.S."

Tractor Beam Specifications

Primary Tractor Beam Load Calculator

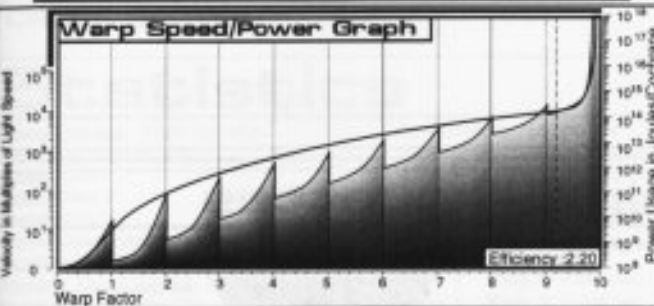
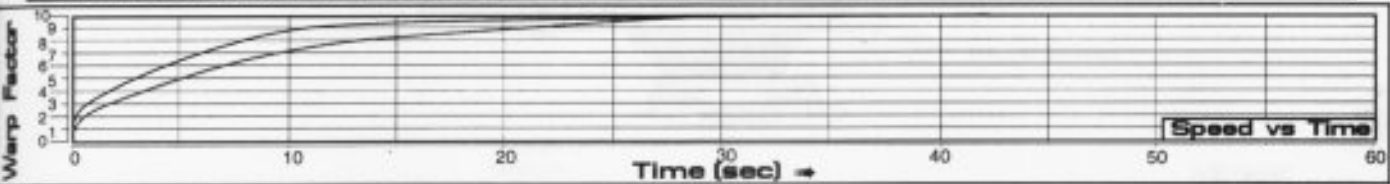
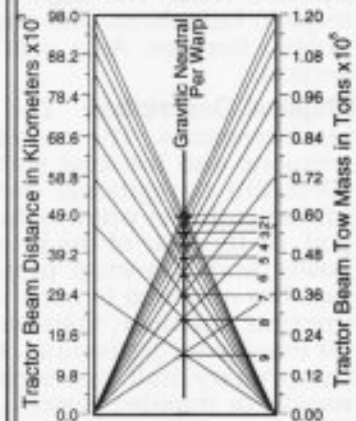

Field Length 404.33m
Field Width 128.38m
Field Height 71.97m

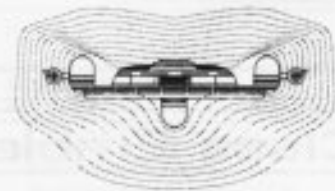

Front Warp Field Profile
Cross Section Area 7549.88 m²

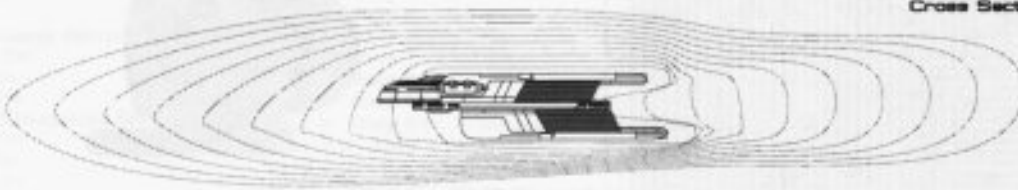

Port Warp Field Profile
Cross Section Area 22289.76 m²

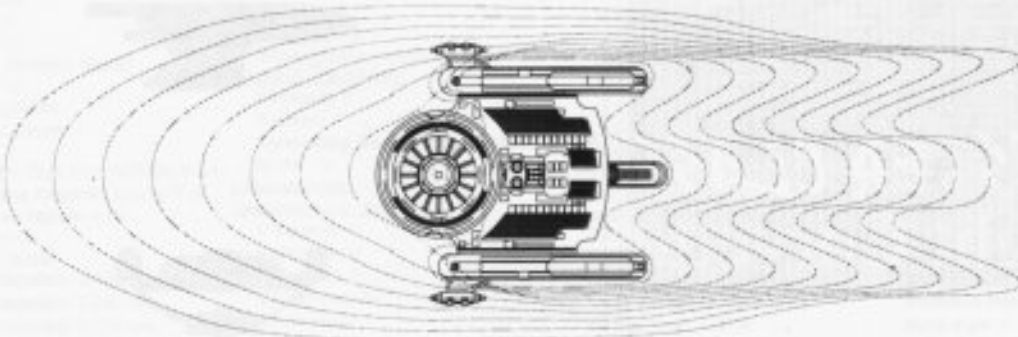

Top Warp Field Profile
Cross Section Area 41188.32 m²

WARP FIELDS

LIGHT CORVETTE



JESTER CLASS

General Information

Specific Role: The Light Corvette is an armed light escort and patrol vessel equipped with photon torpedo launchers. The ship is armed with an Avenger class photon torpedo pod allowing it to deliver a photon barrage. As a cost saving measure the hull is a modified Oberth Class research vessel upper section.

Physical Description: The (SH103/A-P6) ship is equipped with additional targeting sensors and hull reinforcements. The corvette is equipped with a (BF5/A-C5) bridge which incorporates an enhanced weapons and tracking station. On the lower part of the hull is the (SM15/4G) main sensor array and (DN2/2R) navigational dome. Positioned forward of the bridge is a (BP2/30-2C) phaser bank. Slung underneath the primary hull by two (DT/30-15G) connecting dorsals is a (PB4/50-10T) photon torpedo pod. At the rear of the primary hull are (ISR10E/2-SA) dual impulse units which are used for auxiliary power and sub-warp propulsion. The vessel's warp fields are generated by two (SU38/1-2RY) warp nacelles attached to each side of the hull. Running horizontally between the nacelles is the (M24/3-2B) intermix chamber. Installed to the rear of the hull are the (AM3/18-2P) matter/antimatter storage tanks for emergency jettisoning. On the front of the hull is a small hangar deck. In the event of an emergency, the primary hull can separate from one or both of the warp nacelles and proceed on the remaining nacelle or impulse power.

Class Emblem



Ship Silhouettes

Total Target Area 9921.80 m²



Top Silhouette
Area 8647.00 m²



Port Silhouette
Area 1906.72 m²



FEDERATION VESSEL



LIGHT CORVETTE

JESTER CLASS

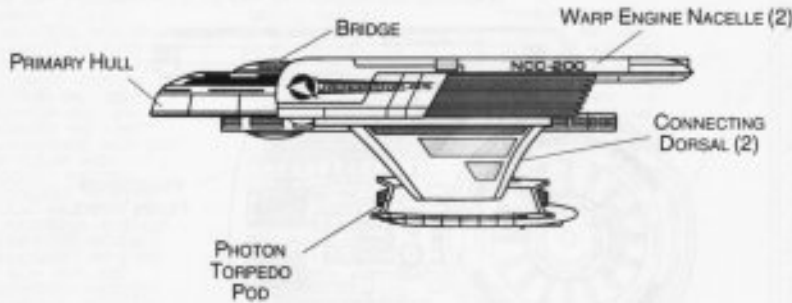

PORT PROFILE

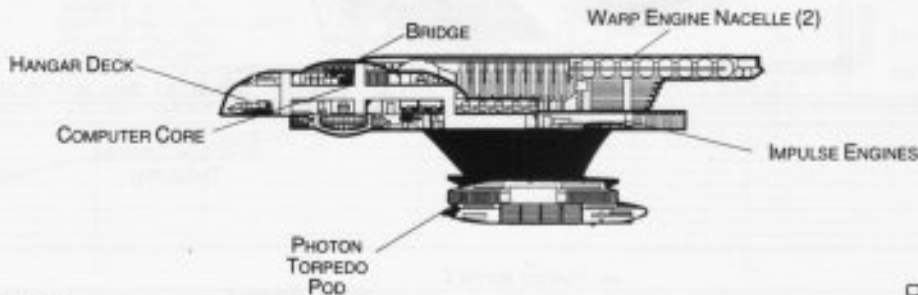

CROSS SECTION



Statistics

Classification: Light Corvette	Optimum Speed: Warp 4	Brigs: 6	ECM Index: 1.02
Category: Assault Ship	Max. Safe Cruising: Warp 5	Replicators: 3	Shield Rating:
Class: Jester	Emergency Speed: Warp 7.3	Tractor Beams: 1	Shield Index: 3.43
Type: Class 2	Max. Speed: Warp 8.5	Tow Capacity: 8.86×10^5 mt	Holdoff Power: 2.24×10^{12} W
Model: MK-IV	Destructive Speed: Warp 9.1	Max Range: 7.74×10^4 km	Refresh Rate: 6.38×10^{11} W
Naval Construction Contract: 200	Acceleration Power: 3.0	Cargo Specification:	Breakdown Rate: 7.65×10^{11} W
Number Proposed: 89	Acceleration Times:	Standard Cargo Units: 55	Shield Dimensions (Meters)
Number Constructed: 82	Warp 1 - Warp 2: 0.253 sec.	Cargo Capacity: 2,750 mt	Length: 129.36m
Number in Service: 75	Warp 2 - Warp 3: 0.404 sec.	Shuttlecraft Specifications:	Width: 99.56m
Number Lost: 7	Warp 3 - Warp 4: 1.529 sec.	Docking Ports: 1	Height: 40.40m
Dimensions:	Warp 4 - Warp 5: 2.199 sec.	Shuttlecraft Bays Total: 1	Weapons:
Overall Dimensions (Meters)	Warp 5 - Warp 6: 2.351 sec.	Small Bay: 1	Phaser Power Index: 0.549
Length: 107.80m	Warp 6 - Warp 7: 2.540 sec.	Medium Bay: 0	Photon Power Index: 15.82
Width: 82.97m	Warp 7 - Warp 8: 3.261 sec.	Large Bay: 0	Vessel Power Index: 8.19
Height: 33.67m	Warp 8 - Warp 9: 4.664 sec.	Super Bay: 0	Weapon Placement:
Primary Hull Dimensions (Meters)	Warp 9 - Warp 9.5: 10.364 sec.	Shuttlecraft Standard: 9	Beam (Phasers) Total: 1 banks 2 each
Length: 92.73m	Warp 9.5 - Warp 9.75: 12.007 sec.	Work Bees: 1	Output: 5.0×10^{11} W / 2.5×10^{11} W
Width: 82.97m	Warp 9.75 - Warp 9.9: 24.899 sec.	Travel Pods: 0	Range: 2.5×10^5 km
Height: 15.22m	Duration (Years)	Aquatic Shuttle: 0	Rate of Fire: 30 ppm / Cont.
Secondary Hull Dimensions (Meters)	Standard: 3 Years	Light Shuttle: 1	Forward Banks: 1
Length: N/A	Maximum: 12 Years	Standard Shuttle: 2	Rear Banks: 0
Width: N/A	Std. Ships Complement: 79	Heavy Shuttle: 0	Port Banks: 0
Height: N/A	Officers: 12	Cargo Shuttle: 1	Starboard Banks: 0
Warp Unit Dimensions (Meters)	Crew (Ensign Grade): 60	Assault Shuttle: 2	Upper Banks: 0
Length: 83.09m	Troops: 7	Killer Bees: 1	Lower Banks: 0
Width: 10.85m	Passengers: 4	Fighter: 1	Beam (MegaPhasers) Total: 0
Height: 12.17m	Emergency condition: +97	Heavy Fighter: 0	Output: N/A
Displacement (Metric Tons)	Medical Facilities:	Lifeboats: 11	Range: N/A
Light: 37,287 mt	Doctors: 2	Turbolift (8 person): 10	Rate of Fire: N/A
Standard: 39,948 mt	Nurses: 11	Lifeboat (10 person): 1	Forward/Rear Banks: 0
Full Load: 44,595 mt	Operating Rooms: 2	Lifeboat (20 person): 0	Port/Starboard Banks: 0
Performance:	Beds: 11	Lifeboat (30 person): 0	Upper/Lower Banks: 0
Impulse Units: Dual Unit (ISR10E/2-SA)	Laboratories: 1	Cloaking Devices: 0	Torpedoes (Photon) Total: 2 bay 2 each
Impulse Engine Output: 6.0×10^{13} W	Transporters Total: 2	Sensor Index Values:	Stock: 60
Impulse Power Index: 4.94	1 Person: 0	Planetary Survey: 0.7093	Range: 2.0×10^5 km
Max Cruising: C	2 Person: 0	Stellar Survey: 0.5254	Output: 10-50 Megatons
Acceleration Rate:	6 Person: 1	Short Range: 1.8395	Rate of Fire: 10 spm
0.00-0.25 Impulse: 0.126 sec.	12 Person: 0	Long Range: 1.3265	Forward Bay: 1
0.25-0.50 Impulse: 0.243 sec.	22 Person: 1	Navigation: 1.3334	Rear Bay: 1
0.50-0.75 Impulse: 0.234 sec.	Small Cargo: 0	Special: 0.6955	Port Bay: 0
0.75-Full Impulse: 0.404 sec.	Medium Cargo: 0	Computers: 2	Starboard Bay: 0
Warp Units: 2 Nacelle Units (SU38/1-2RY)	Large Cargo: 0	Type: Daystrom Duotronic II-f	Upper Bay: 0
Warp Engine Output: 1.92×10^{14} W	Super Cargo: 0	Type: Daystrom Duotronic II-f	Lower Bay: 0
Warp Power Index: 0.79			

FEDERATION VESSEL

LIGHT CORVETTE



JESTER CLASS

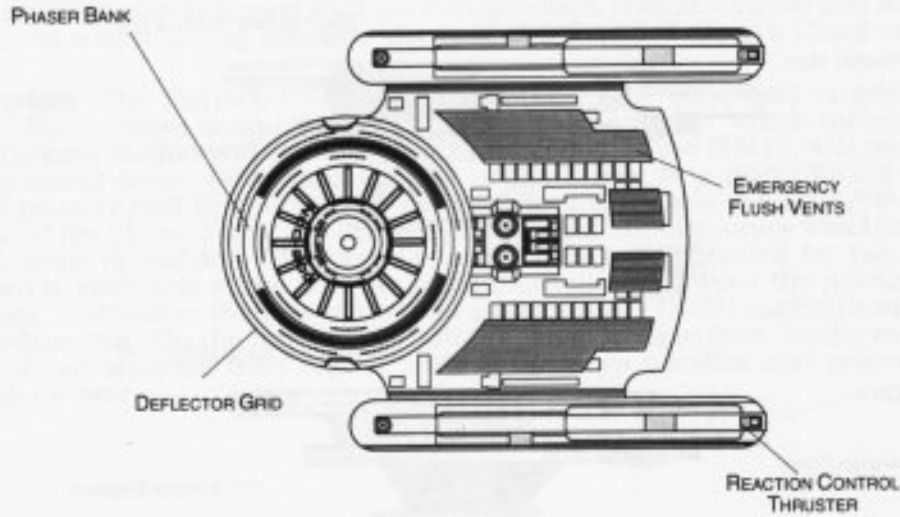

TOP PROFILE

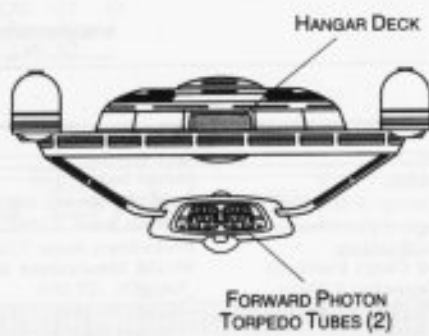

FRONT PROFILE

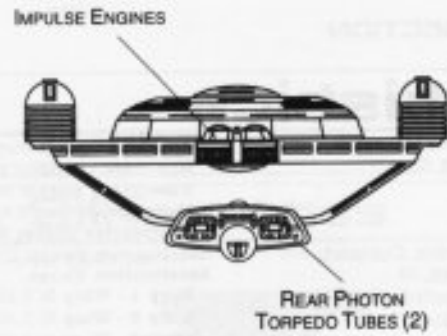

REAR PROFILE

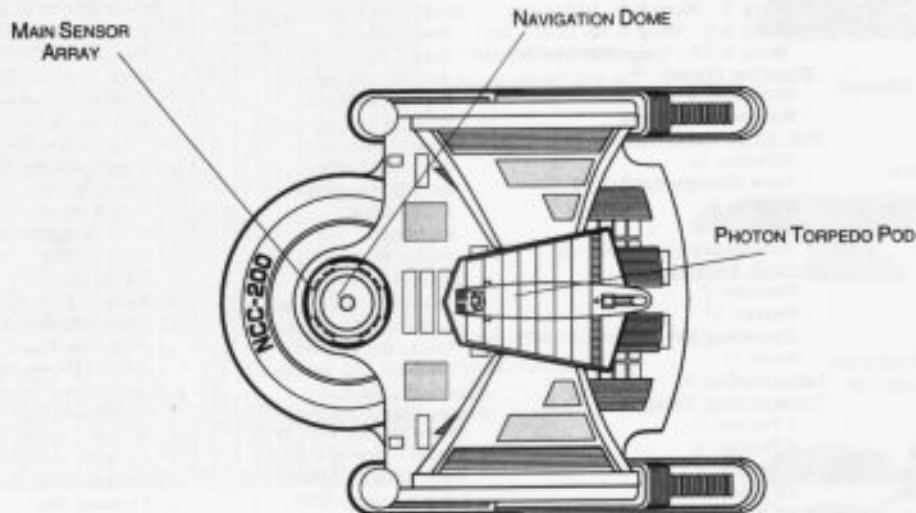

BOTTOM PROFILE



FEDERATION VESSEL



LIGHT CORVETTE

Ship Names

THE FOLLOWING SHIPS OF THE MK-IV CLASS WERE AUTHORIZED BY THE AMENDED ARTICLES OF FEDERATION OF STARDATE 2268.6

ANGEL RUBIO *NCC-219	GAILEY *NCC-201	MORSE *NCC-237	TINSLEY *NCC-252
BAKDASH *NCC-251	GALLEGOS *NCC-216	NADER COVAIR *NCC-275**	TISDALE *NCC-207
BERLINGERI *NCC-245	GARBAY *NCC-266	NARAYAN *NCC-225	TONGATE *NCC-222
CEIRDA *NCC-270	GERSTNER *NCC-227	NIKULA *NCC-210	TORGERTSON *NCC-241
COVINGTON *NCC-213	GLASNER *NCC-274	NODURFT *NCC-280	TRANHAM *NCC-259
COX *NCC-203	JESTER *NCC-200*	NOLTE *NCC-257	TURNPIN *NCC-214
COYKENDALL *NCC-226	KENNON *NCC-244	NORIEGA *NCC-236	ULLRICH *NCC-246
CRADDOCK *NCC-255	KISSACK *NCC-286***	OTTAWAY *NCC-288***	UNDERDOG *NCC-208**
DEIAROSA *NCC-284***	LAVERDEIRE *NCC-283***	OTTO *NCC-234	VASQUEZ *NCC-229
DELLINGER *NCC-272	LE' CLEAR *NCC-265	PANTEL *NCC-240	VEJAR *NCC-239
DEMAREST *NCC-253	LOONEY *NCC-261	PAPPAS *NCC-228	WRETCH *NCC-232
DUNN *NCC-235	LOVELESS *NCC-283	PFENNING *NCC-206	YORK *NCC-268**
DUPREE *NCC-247	LUCIO *NCC-311	PHARIS *NCC-279	ZAVISCA *NCC-267
DYKSTRA *NCC-218	LUMINARIA *NCC-238	PIDON *NCC-262	ZEIGLER *NCC-277
EAGAN *NCC-202	LUNDBERG *NCC-220	POLOMSKY *NCC-212	
EATHERLY *NCC-209	LUNDQUIST *NCC-248	PYCORA *NCC-243	
ERHART *NCC-231	LYNCH *NCC-230	QUINTANNA *NCC-224	
ESTES *NCC-276	McCREADY *NCC-204	REPSTINE *NCC-233	
ETGEN *NCC-221	McINTYRE *NCC-223**	REQJAT *NCC-278	
EVLSIZER *NCC-258**	McVAY *NCC-249	RICOSTA *NCC-254	
EYLA *NCC-242	MERMEA *NCC-271	ROOHA *NCC-281	
FAHSCHOLTZ *NCC-287***	MERRY ENGRAM *NCC-285***	ROOUE *NCC-250	
FOUST *NCC-260	MILLIGAN *NCC-269	ROSENBERG *NCC-205	
FREDENBURG *NCC-282***	MORADO *NCC-255**	SALTAMACHO *NCC-215	
FUQUA *NCC-264	MORGANTI *NCC-217**	TINKER *NCC-273	

Tractor Beam Specifications

Primary Tractor Beam Load Calculator

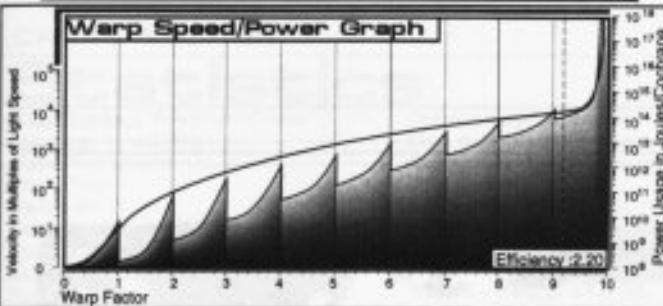
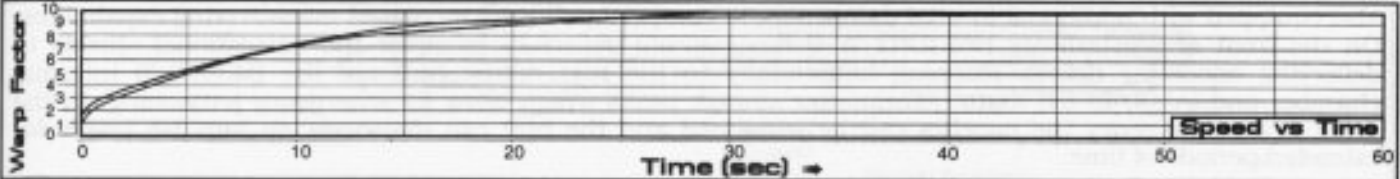
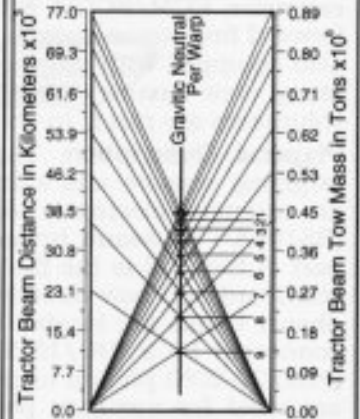

Field Length 396.92m
Field Width 126.32m
Field Height 89.33m

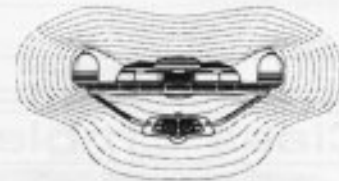

Front Warp Field Profile
Cross Section Area 6812.16 m²

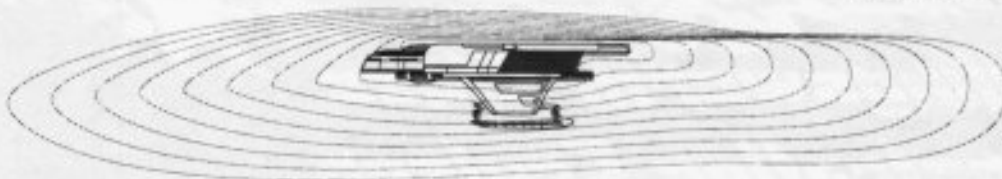

Port Warp Field Profile
Cross Section Area 21122.96 m²

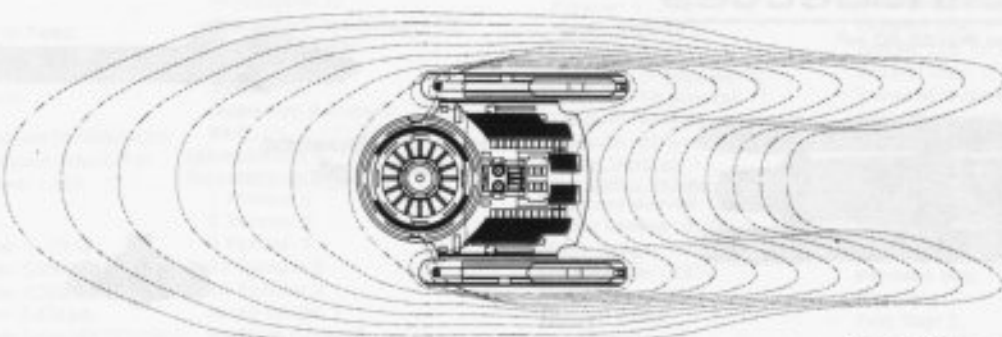

Top Warp Field Profile
Cross Section Area 38851.04 m²

WARP FIELDS

SRM2 04:02:06:04

STARFLEET REFERENCE MANUAL

JESTER CLASS

FEDERATION VESSEL

PENETRATION CRUISER



General Information

Specific Role: The Penetration Cruiser is a swift, deep penetration, point assault ship. In addition to extensive ECM/ECCM equipment and high powered shields, the small frontal target area and heavy forward fire-power make it well suited for deep surgical strikes in heavily defended positions. The cruiser is also equipped with advanced warp nacelles to give it superior acceleration and maneuverability. Although many crew luxuries were limited in order to maintain the cruisers stringent design criteria, top notch volunteers are rarely in short supply.

Physical Description: The (PH217/A-M15) reinforced double-thick hull is equipped with additional targeting sensors and a small hangar deck located amid-ship. Integrated into the standard deflector grid are extensive electronic counter-measures to make the vessel more stealthy. The hull is equipped with an (BS10/A-T7) assault bridge which incorporates an enhanced weapons and tracking station. On the lower part of the hull is the (SM49/5G) main sensor array and (DN4/4-G) navigational dome. Mounted to port, starboard and bow directly below the bridge are three (BP2/30-2C) phaser banks. Additional (BP2/30-2C) phaser banks are located front and rear on the underside of the hull. Above and to the rear of the bridge connected by a (DU/15-5T) support pylon are slamed (MP2/15-2S) MegaPhasers. To the front is the (PB2/25-20N) photon torpedo bay. At the rear of the hull are the (IP186E/4-OH) dual impulse units which are used for auxiliary power and sub-warp propulsion. The vessel's warp fields are generated by two (SY71/1-5BH) advanced warp nacelles attached to the hull by (DU/10-6C) support pylons. The vessel is also equipped with additional inertial dampeners to compensate for its increased maneuvering capabilities. On the front of the hull are two (DN1/A-4) navigational deflectors to assist the navigational shields in deflecting oncoming debris. Running longitudinally to the rear of the hull are the (M36/6-3) intermix chamber and (AM8/48-5T) matter/antimatter storage tanks which allow for emergency jettisoning. In the event of an emergency the nacelles can be jettisoned and the hull can maneuver on impulse power for extended periods of time.

Class Emblem



Ship Silhouettes

Total Target Area 20189.40 m²



Top Silhouette
Area 14016.48 m²



Port Silhouette
Area 4555.40 m²



Front Silhouette
Area 1597.52 m²



PENETRATION CRUISER

HOLLINGSWORTH CLASS

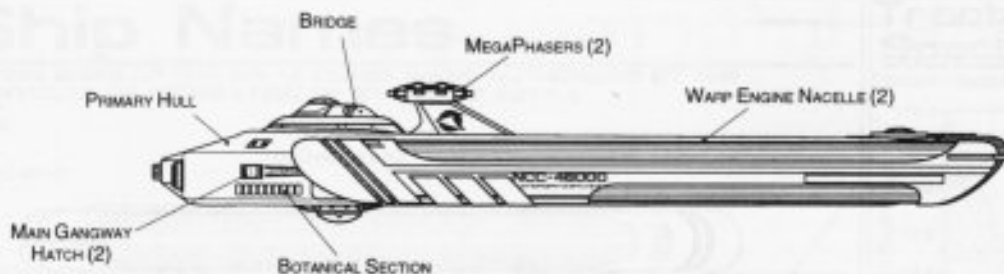

PORT PROFILE

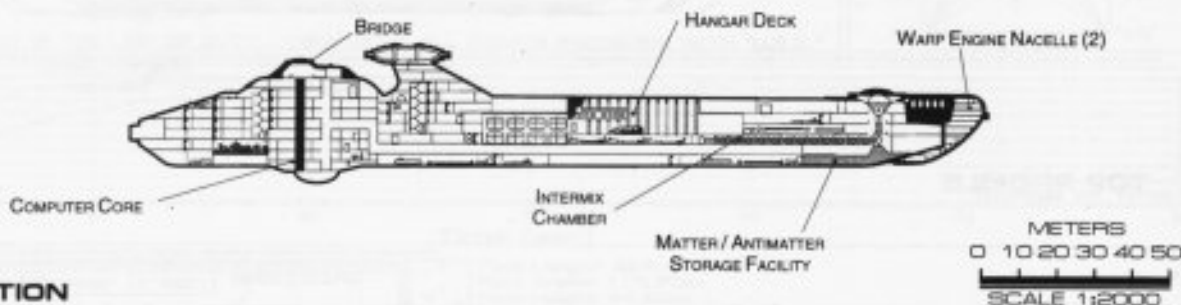

CROSS SECTION

Statistics

Classification: Penetration Cruiser

Category: Assault Ship

Class: Hollingsworth

Type: Class 2

Model: MK-VI

Naval Construction Contract: 46000

Number Proposed: 12

Number Constructed: 5

Number in Service: 5

Number Lost: 0

Dimensions:

Overall Dimensions (Meters)

Length: 215.43m

Width: 42.51m

Height: 34.76m

Primary Hull Dimensions (Meters)

Length: 207.01m

Width: 37.55m

Height: 31.56m

Secondary Hull Dimensions (Meters)

Length: N/A

Width: N/A

Height: N/A

Warp Unit Dimensions (Meters)

Length: 177.51m

Width: 26.84m

Height: 17.66m

Displacement (Metric Tons)

Light: 176,212mt

Standard: 188,792mt

Full Load: 210,752mt

Performance:

Impulse Units: Dual Unit (IP186E/4-OH)

Impulse Engine Output: 7.8×10^{13} W

Impulse Power Index: 1.050

Max Cruising: C

Acceleration Rate:

0.00-0.25 Impulse: 0.191 sec.

0.25-0.50 Impulse: 0.287 sec.

0.50-0.75 Impulse: 0.382 sec.

0.75-Full Impulse: 0.478 sec.

Warp Units: 2 Nacelle Units (SY71/1-6BH)

Warp Engine Output: 2.16×10^{15} W

Warp Power Index: 1.88

Optimum Speed: Warp 7

Max. Safe Cruising: Warp 8.6

Emergency Speed: Warp 9.52

Max. Speed: Warp 9.72

Destructive Speed: Warp 9.82

Acceleration Power: 3.0

Acceleration Times:

Warp 1 - Warp 2: 0.106 sec.

Warp 2 - Warp 3: 0.170 sec.

Warp 3 - Warp 4: 0.642 sec.

Warp 4 - Warp 5: 0.924 sec.

Warp 5 - Warp 6: 0.988 sec.

Warp 6 - Warp 7: 1.067 sec.

Warp 7 - Warp 8: 1.370 sec.

Warp 8 - Warp 9: 1.959 sec.

Warp 9 - Warp 9.5: 4.354 sec.

Warp 9.5 - Warp 9.75: 5.044 sec.

Warp 9.75 - Warp 9.9: 10.460 sec.

Duration (Years)

Standard: 4 Years

Maximum: 16 Years

Std. Ships Complement: 341

Officers: 54

Crew (Ensign Grade): 261

Troops: 26

Passengers: 22

Emergency condition: +428

Medical Facilities:

Doctors: 4

Nurses: 21

Operating Rooms: 3

Beds: 21

Laboratories: 6

Transporters Total: 7

1 Person: 0

2 Person: 0

6 Person: 3

12 Person: 0

22 Person: 3

Small Cargo: 1

Medium Cargo: 0

Large Cargo: 0

Super Cargo: 0

Brigs: 22

Replicators: 14

Tractor Beams: 1

Tow Capacity: 7.12×10^6 mt

Max Range: 1.78×10^6 km

Cargo Specification:

Standard Cargo Units: 154

Cargo Capacity: 6,700mt

Shuttlecraft Specifications:

Docking Ports: 2

Shuttlecraft Bays Total: 1

Small Bay: 0

Medium Bay: 1

Large Bay: 0

Super Bay: 0

Shuttlecraft Standard: 23

Work Bees: 1

Travel Pods: 1

Aquatic Shuttle: 0

Light Shuttle: 1

Standard Shuttle: 5

Heavy Shuttle: 1

Cargo Shuttle: 1

Assault Shuttle: 3

Killer Bees: 3

Fighter: 4

Heavy Fighter: 3

Lifeboats: 37

Turbolift (8 person): 22

Lifeboat (10 person): 11

Lifeboat (20 person): 5

Lifeboat (30 person): 0

Cloaking Devices: 1

Sensor Index Values:

Planetary Survey: 0.5877

Stellar Survey: 0.4775

Short Range: 1.5205

Long Range: 1.2354

Navigation: 1.6000

Special: 0.9387

Computers: 2

Type: Daystrom Duotronic III:r

Type: Daystrom Duotronic II:r

ECM Index: 1.51/3.0

Shield Rating:

Shield Index: 1.56

Holdoff Power: 4.82×10^{12} W

Refresh Rate: 1.37×10^{12} W

Breakdown Rate: 1.84×10^{12} W

Shield Dimensions (Meters)

Length: 272.12m

Width: 91.58m

Height: 43.91m

Weapons:

Phaser Power Index: 1.18

Photon Power Index: 6.73

Vessel Power Index: 3.94

Weapon Placement:

Beam (Phasers) Total: 5 banks 2 each

Output: 5.0×10^{11} W / 2.5×10^{11} W

Range: 2.5×10^5 km

Rate of Fire: 30 ppm / Cont.

Forward Banks: 1

Rear Banks: 0

Port Banks: 1

Starboard Banks: 1

Upper Banks: 0

Lower Banks: 2

Beam (MegaPhasers) Total: 2

Output: 2.6×10^{12} W / 1.3×10^{12} W

Range: 1.0×10^6 km

Rate of Fire: 15 ppm / Cont.

Forward/Rear Banks: 2

Port/Starboard Banks: 0

Upper/Lower Banks: 0

Torpedoes (Photon) Total: 1 Bay 2 each

Stock: 100

Range: 2.0×10^5 km

Output: 10-50 Megatons

Rate of Fire: 20 ppm

Forward Bay: 1

Rear Bay: 0

Port Bay: 0

Starboard Bay: 0

Upper Bay: 0

Lower Bay: 0

FEDERATION VESSEL

PENETRATION CRUISER



HOLLINGSWORTH CLASS

FEDERATION VESSEL

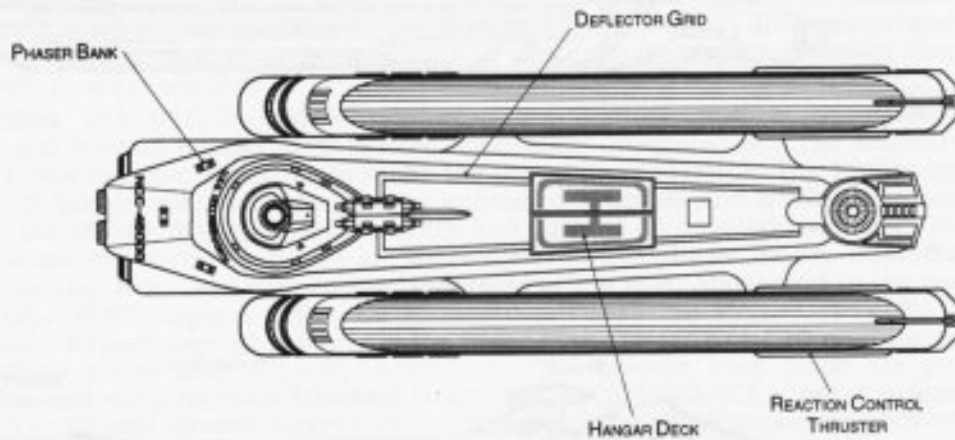

TOP PROFILE

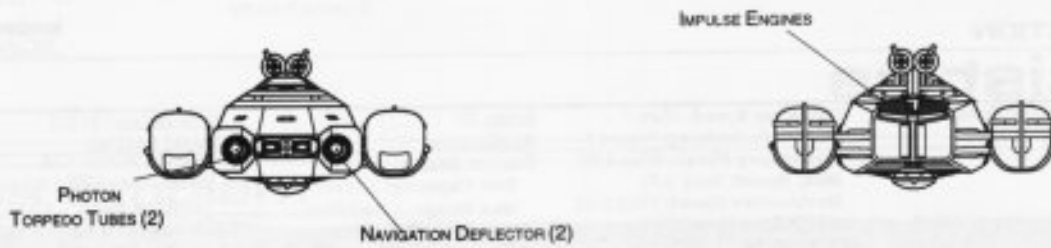

FRONT PROFILE

REAR PROFILE

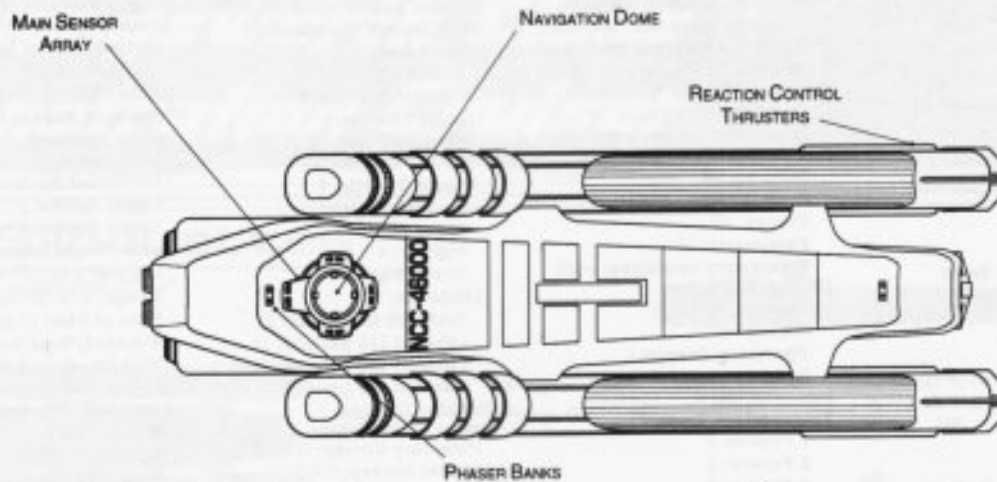

BOTTOM PROFILE

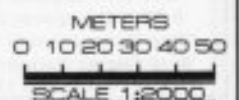



PENETRATION CRUISER

Ship Names

THE FOLLOWING SHIPS OF THE MK-VI CLASS WERE AUTHORIZED BY THE AMENDED ARTICLES OF FEDERATION OF STARDATE 2274.1

- BEATON *NCC-46011***
- CAMPBELL *NCC-46003
- COOK *NCC-46001
- GILLIS *NCC-46008***
- HOLLINGSWORTH *NCC-46000*
- HOUCK *NCC-46010***
- JERUE *NCC-46005***
- KENNARD *NCC-46002
- McPHEE *NCC-46004
- NAPIER *NCC-46007***
- SUTHERLAND *NCC-46009***
- SUTTON *NCC-46006***

*CLASS SHIP. **LOST IN THE LINE OF DUTY. ***PROPOSED. ALL NAMES PRECEDED WITH "U.S.S."

Tractor Beam Specifications

Primary Tractor Beam Load Calculator

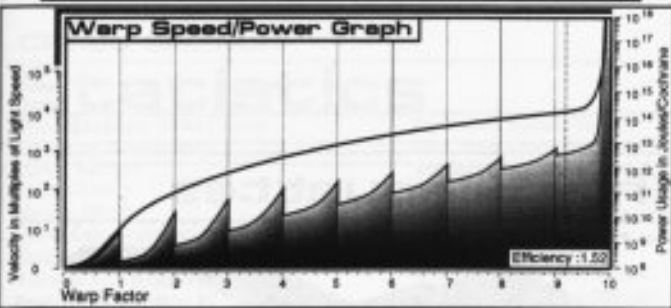
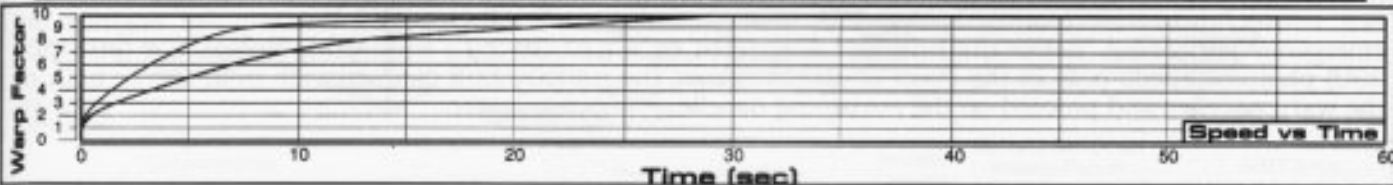
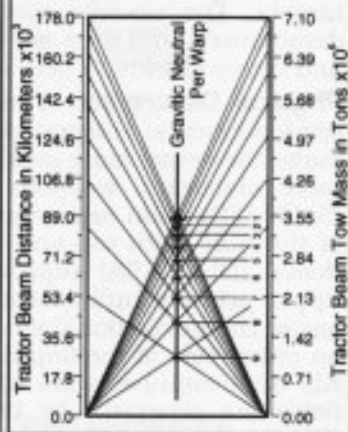

Field Length 824.41m
Field Width 175.70m
Field Height 84.69m

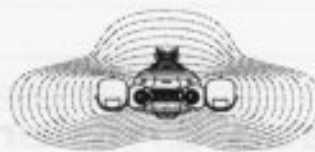

Front Warp Field Profile
Cross Section Area 10943.72 m²



Port Warp Field Profile
Cross Section Area 34757.44 m²

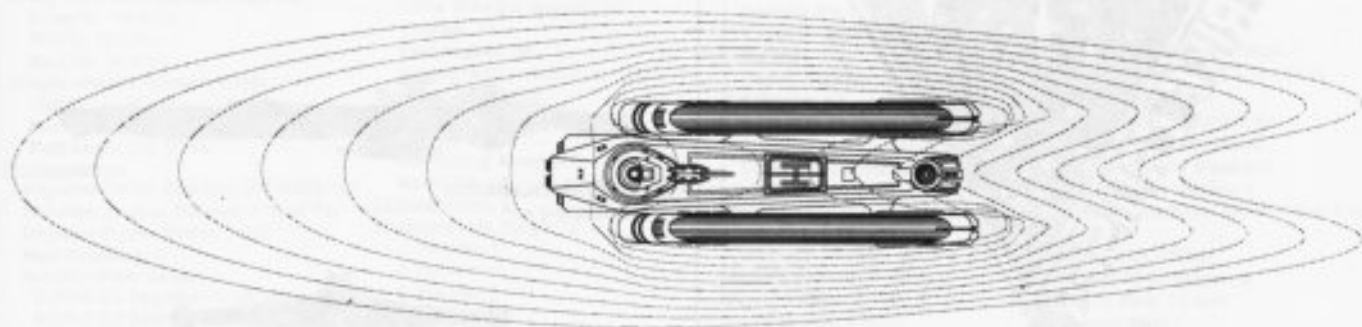

Top Warp Field Profile
Cross Section Area 73317.52 m²

WARP FIELDS

SRM2 04:02:07:04

STARFLEET REFERENCE MANUAL

HOLLINGSWORTH

FEDERATION VESSEL

STRIKE CRUISER



General Information

Specific Role: The Strike Cruiser is designed to deliver special forces and fighter craft to heavily defended targets. The vessel's speed and low profile allow it to infiltrate contested zones, deliver its assault detachment, and then move into a support position. The vessel contains extensive ECM equipment, sensors and heavy shields to help it survive and support its assault teams.

Physical Description: The (PHE212/A-M4) hull is equipped with additional targeting sensors and hull reinforcements. Integrated into the standard deflector grid are additional electronic counter-measures to make the vessel more stealthy. The hull is equipped with the (BS10/A-T9) bridge which incorporates larger, more elaborate, weapons, surveillance and tracking stations. On the lower part of the hull is the (SM49/7D) main sensor array and (DN4/2-G) navigational dome. Located on the port, starboard and bow of the hull (both top and bottom) are six (BP2/30-2C) phaser banks. Above the hull and connected by a dorsal (DU/20-5A) support pylon are (MP2/15-2S) Siamesed MegaPhasers. Port and starboard on the upper primary hull forward of the raised extension, are the (DN2/G-4.2) navigational deflectors used to assist the navigational shields in deflecting oncoming debris. Two medium hangar decks are installed, one on either side of the impulse engines, in the rear of the primary hull. To the rear of the hull are (IP186E/5-KL) dual impulse units which are used for auxiliary power and sub-warp propulsion. The vessel's warp fields are generated by two (SW52/1-5FR) warp nacelles attached to each side of the primary hull by (DU/25-7J) support pylons. In the stern of the hull are the (M36/4-2G) intermix chamber and (AM8/48-3D) matter/antimatter storage tanks. The storage tanks are located below the impulse engines for emergency jettisoning. Below the hull and supported by a (DU/38-32C) connecting dorsal is a (PB3/50-30U) photon torpedo pod. In the event of an emergency the primary hull can separate from one or both of the warp nacelles and proceed on the remaining nacelle or impulse power.

MAXWELL CLASS

Class Emblem



Ship Silhouettes

Total Target Area 40003.18 m²



Top Silhouette
Area 31289.08 m²

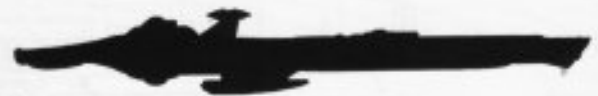

Port Silhouette
Area 5890.84 m²



Front Silhouette
Area 2843.24 m²

FEDERATION VESSEL



STRIKE CRUISER

MAXWELL CLASS

FEDERATION VESSEL

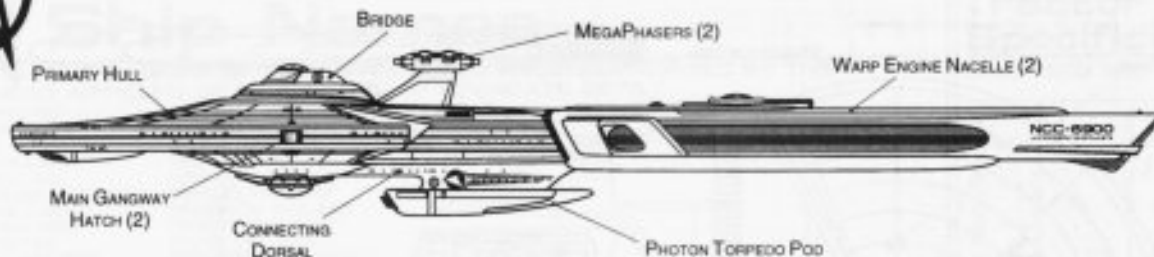

PORT PROFILE



CROSS SECTION

Statistics

Classification: Strike Cruiser

Category: Assault Ship

Class: Maxwell

Type: Class 1

Model: MK-VII

Naval Construction Contract: 6900

Number Proposed: 42

Number Constructed: 36

Number in Service: 35

Number Lost: 1

Dimensions:

Overall Dimensions (Meters)

Length: 289.50m

Width: 141.72m

Height: 40.89m

Primary Hull Dimensions (Meters)

Length: 202.03m

Width: 141.72m

Height: 32.94m

Secondary Hull Dimensions (Meters)

Length: N/A

Width: N/A

Height: N/A

Warp Unit Dimensions (Meters)

Length: 154.81m

Width: 12.63m

Height: 18.32m

Displacement (Metric Tons)

Light: 177,371mt

Standard: 190,033mt

Full Load: 212,137mt

Performance:

Impulse Units: Dual Unit (IRF35E/5-KL)

Impulse Engine Output: 7.8×10^{13} W

Impulse Power Index: 1.040

Max Cruising: C

Acceleration Rate:

0.00-0.25 Impulse: 0.192 sec.

0.25-0.50 Impulse: 0.289 sec.

0.50-0.75 Impulse: 0.385 sec.

0.75-Full Impulse: 0.481 sec.

Warp Units: 2 Nacelle Units (SW52/1-5FR)

Warp Engine Output: 1.2×10^{15} W

Warp Power Index: 1.040

Optimum Speed: Warp 5

Max. Safe Cruising: Warp 7

Emergency Speed: Warp 8.6

Max. Speed: Warp 9.2

Destructive Speed: Warp 9.35

Acceleration Power: 3.0

Acceleration Times:

Warp 1 - Warp 2: 0.192 sec.

Warp 2 - Warp 3: 0.308 sec.

Warp 3 - Warp 4: 1.164 sec.

Warp 4 - Warp 5: 1.674 sec.

Warp 5 - Warp 6: 1.789 sec.

Warp 6 - Warp 7: 1.934 sec.

Warp 7 - Warp 8: 2.482 sec.

Warp 8 - Warp 9: 3.550 sec.

Warp 9 - Warp 9.5: 7.888 sec.

Warp 9.5 - Warp 9.75: 9.139 sec.

Warp 9.75 - Warp 9.9: 18.951 sec.

Duration (Years)

Standard: 5 Years

Maximum: 20 Years

Std. Ships Complement: 539

Officers: 86

Crew (Ensign Grade): 420

Troops: 33

Passengers: 36

Emergency condition: +691

Medical Facilities:

Doctors: 6

Nurses: 32

Operating Rooms: 5

Beds: 32

Laboratories: 6

Transporters Total: 12

1 Person: 0

2 Person: 0

6 Person: 5

12 Person: 0

22 Person: 5

Small Cargo: 1

Medium Cargo: 1

Large Cargo: 0

Super Cargo: 0

Brigs: 21

Replicators: 14

TraCTOR Beams: 1

Tow Capacity: 3.64×10^6 mt

Max Range: 1.09×10^5 km

Cargo Specification:

Standard Cargo Units: 219

Cargo Capacity: 10,950mt

Shuttlecraft Specifications:

Docking Ports: 4

Shuttlecraft Bays Total: 2

Small Bay: 0

Medium Bay: 2

Large Bay: 0

Super Bay: 0

Shuttlecraft Standard: 47

Work Bees: 2

Travel Pods: 2

Aquatic Shuttle: 0

Light Shuttle: 2

Standard Shuttle: 8

Heavy Shuttle: 0

Cargo Shuttle: 1

Assault Shuttle: 5

Killer Bees: 6

Fighter: 11

Heavy Fighter: 8

Lifeboats: 49

Turbolift (8 person): 21

Lifeboat (10 person): 19

Lifeboat (20 person): 8

Lifeboat (30 person): 1

Cloaking Devices: 0

Sensor Index Values:

Planetary Survey: 0.8794

Stellar Survey: 0.7322

Short Range: 1.1832

Long Range: 0.9852

Navigation: 1.2292

Special: 0.9496

Computers: 2

Type: Daystrom Duotronic III:z

Type: Daystrom Duotronic II:h

ECM Index: 1.38

Shield Rating:

Shield Index: 1.21

Holdoff Power: 3.78×10^{12} W

Refresh Rate: 1.08×10^{12} W

Breakdown Rate: 1.29×10^{12} W

Shield Dimensions (Meters)

Length: 365.69m

Width: 212.46m

Height: 51.66m

Weapons:

Phaser Power Index: 1.29

Photon Power Index: 5.61

Vessel Power Index: 3.45

Weapon Placement:

Beam (MegaPhasers) Total: 6 banks 2 each

Output: 5.0×10^{11} W / 2.5×10^{11} W

Range: 2.5×10^5 km

Rate of Fire: 30 ppm / Cont.

Forward Banks: 2

Rear Banks: 0

Port Banks: 2

Starboard Banks: 2

Upper Banks: 0

Lower Banks: 0

Beam (MegaPhasers) Total: 2

Output: 2.6×10^{12} W / 1.3×10^{12} W

Range: 1.0×10^6 km

Rate of Fire: 15 ppm / Cont.

Forward/Rear Banks: 0

Port/Starboard Banks: 0

Upper/Lower Banks: 4

Torpedoes (Photon) Total: 1 Bay 3 each

Stock: 90

Range: 2.0×10^5 km

Output: 10-50 Megatons

Rate of Fire: 10 spm

Forward Bay: 1

Rear Bay: 0

Port Bay: 0

Starboard Bay: 0

Upper Bay: 0

Lower Bay: 0

STRIKE CRUISER



MAXWELL CLASS

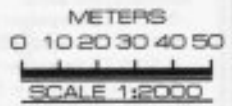
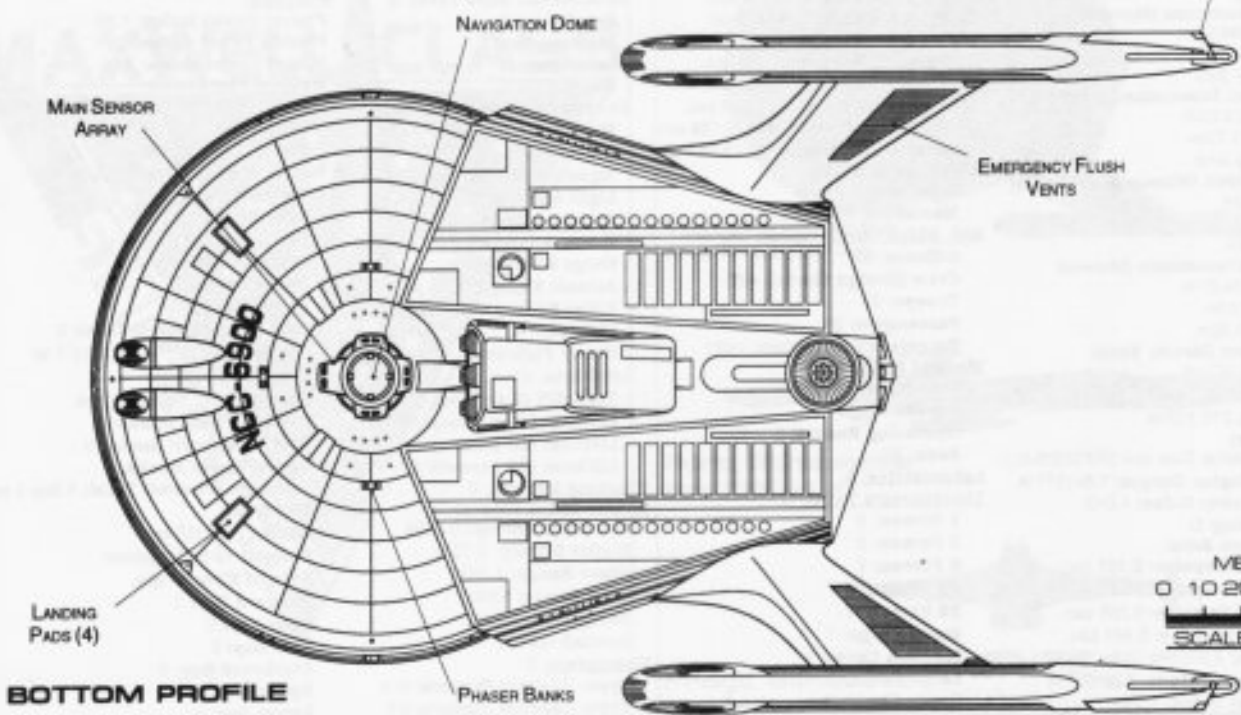
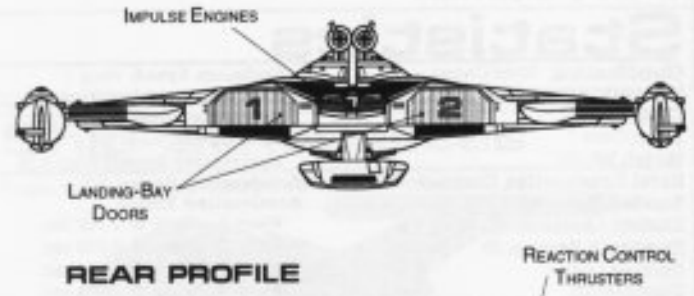
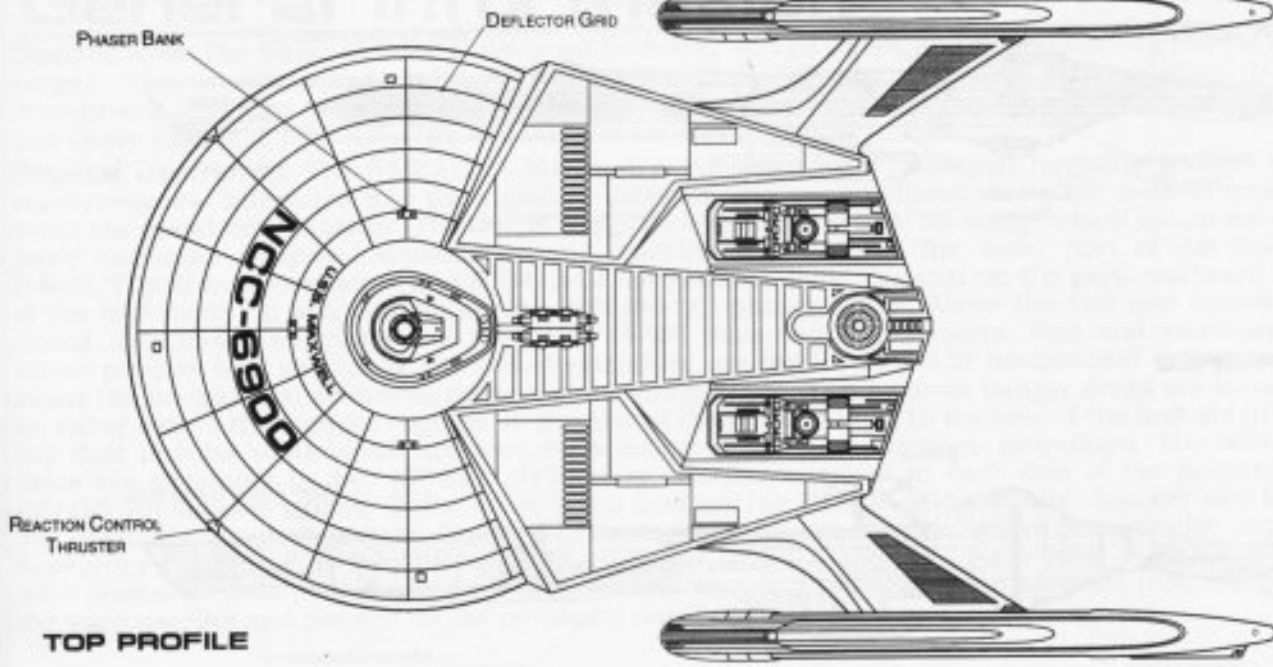

FEDERATION VESSEL



STRIKE CRUISER

Ship Names

THE FOLLOWING SHIPS OF THE MK-VII CLASS WERE AUTHORIZED BY THE AMENDED ARTICLES OF FEDERATION OF STARDATE 2273.1

- | | |
|------------------------|-----------------------|
| ABRAMS *NCC-6901 | LEIBFRIED *NCC-6924 |
| ARTIAGA *NCC-6912 | MAXWELL *NCC-6900* |
| ASCENSIO *NCC-6928 | MOJICA *NCC-6911 |
| ASQUITH *NCC-6940*** | NESKORIK *NCC-6923 |
| BRADIC *NCC-6905 | O'ROURKE *NCC-6930 |
| BRECKENRIDGE *NCC-6914 | PERALES *NCC-6932 |
| BRIDEAU *NCC-6937*** | PINKERTON *NCC-6925 |
| CADELL *NCC-6936*** | PROFIT *NCC-6938*** |
| CAKIR *NCC-6920 | PUJARI *NCC-6913 |
| CROOFOOT *NCC-6907 | PURKEYPILE *NCC-6906 |
| DRABEK *NCC-6917 | VERUCCHI *NCC-6941*** |
| DRENNAN *NCC-6926 | VILAFRANCO *NCC-6922 |
| D'SOUZA *NCC-6933 | WACLAWCZYK *NCC-6909 |
| FAXTON *NCC-6903 | WALVROOD *NCC-6905 |
| FUNDERBURK *NCC-6904 | ZENON *NCC-6916 |
| GANT *NCC-6915 | ZION *NCC-6929 |
| GODOY *NCC-6921 | ZOROLA *NCC-6902 |
| GOODNIGHT *NCC-6939*** | |
| GRABOWSKI *NCC-6934 | |
| GRIGSBY *NCC-6908** | |
| HAGBERG *NCC-6919 | |
| JACOBI *NCC-6910 | |
| KESTERSON *NCC-6927 | |
| KREIG *NCC-6918 | |
| LEATHERBURY *NCC-6931 | |

*CLASS SHIP, **LOST IN THE LINE OF DUTY, ***PROPOSED. ALL NAMES PRECEDED WITH "U.S.S."

Tractor Beam Specifications

Primary Tractor Beam Load Calculator

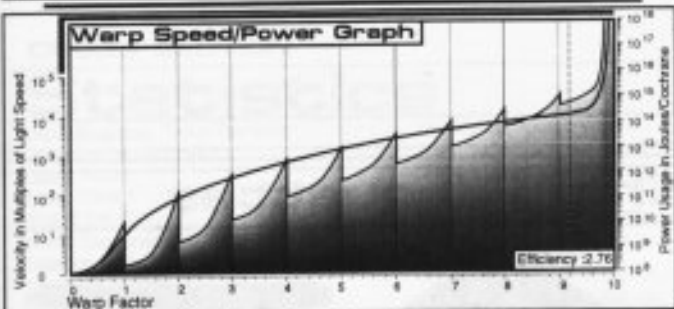
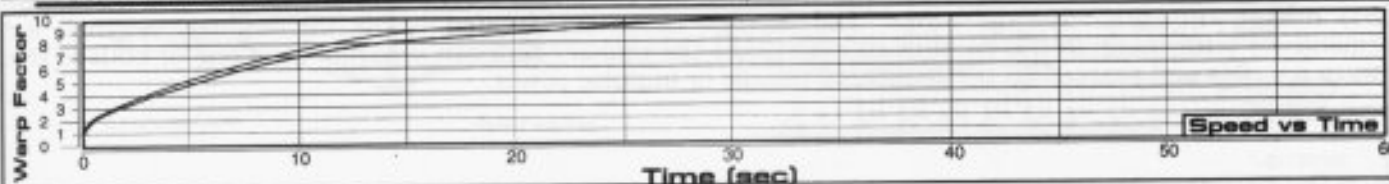
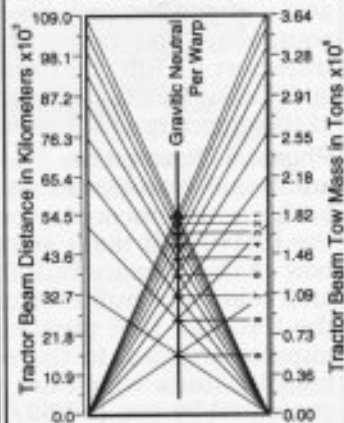

Field Length 682.70m
Field Width 228.18m
Field Height 97.38m

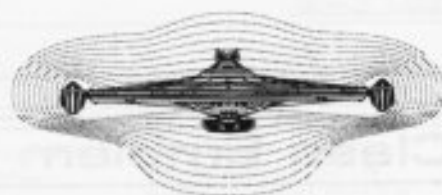

Front Warp Field Profile
Cross Section Area 14830.08 m²

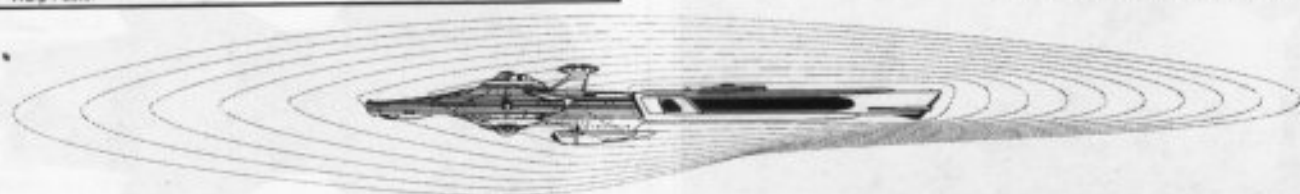

Port Warp Field Profile
Cross Section Area 42719.92 m²

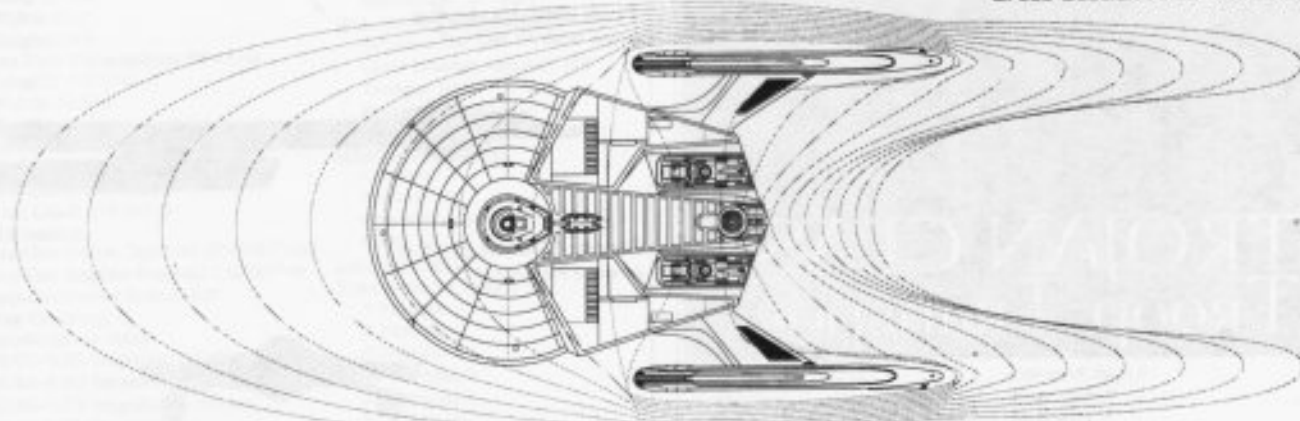

Top Warp Field Profile
Cross Section Area 109276.80 m²

WARP FIELDS

TROOP TRANSPORT



General Information

Specific Role: The Troop Transport is designed to deliver large numbers of troops and their equipment to areas of conflict in both assault and peace keeping roles. The transport is equipped with extensive ECM equipment and heavy shields to help support its troops. For quick troop delivery the ship is able to transport its full complement (1000 troops) and support craft in less than a minute, and then move into a supporting position. The troops are housed in large bunk facilities (20 to a room) to reduce the overall size of the ship required to deliver them.

Physical Description: The (PHE313/A-M7) hull is an extension of the standard primary hull and contains additional transporter equipment and troop accommodations. The hull is equipped with the (BS9/A-T2) bridge which incorporates a larger survey and weapons stations. On the lower part of the primary hull is the (SM49/4E) main sensor array and (DN4/5-B) navigational dome. Located on the port, starboard and bow of the primary hull (both top and bottom) are five (BP2/30-2C) phaser banks. To the rear both above and below the hull extension are four additional (BP2/30-2C) phaser banks. Just in front of the bridge is the (PB2/25-10F) photon torpedo bay. Two medium hangar decks are installed, one on either side of the impulse engines, in the rear of the primary hull. To the rear of the primary hull are (IP186E/7-VE) dual impulse units which are used for auxiliary power and sub-warp propulsion. The vessel's warp fields are generated by two (SW52/1-5GY) warp nacelles attached to the underside of the hull extension by (DU/22-5R) support pylons. In the rear of the hull extension are the (M28/4-3T) intermix chamber and (AM8/36-5T) matter/antimatter storage tanks. The storage tanks are located below the impulse engines for emergency jettisoning. In the event of an emergency the primary hull can separate from one or both of the warp nacelles and proceed on the remaining nacelle or impulse power.

TROJAN CLASS

Class Emblem

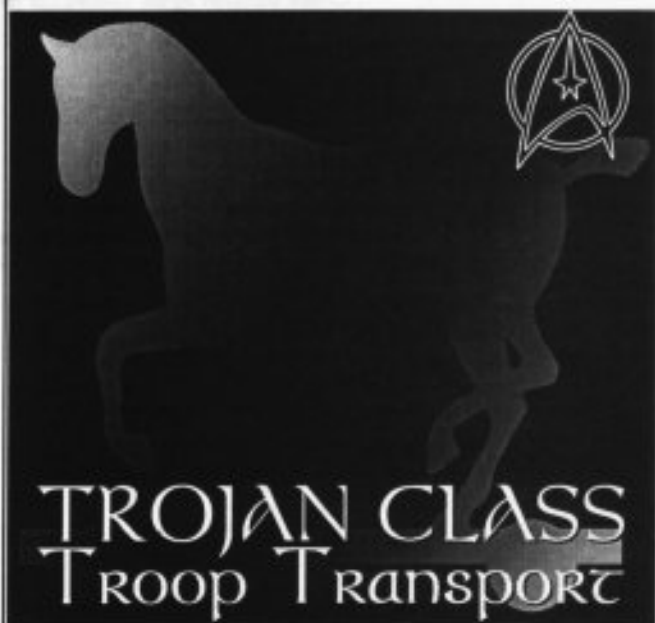

Ship Silhouettes

Total Target Area 43344.24 m²



Top Silhouette
Area 35571.80 m²



Port Silhouette
Area 7768.44 m²



Front Silhouette
Area 2846.80 m²

FEDERATION VESSEL

TROOP TRANSPORT

TROJAN CLASS

FEDERATION VESSEL

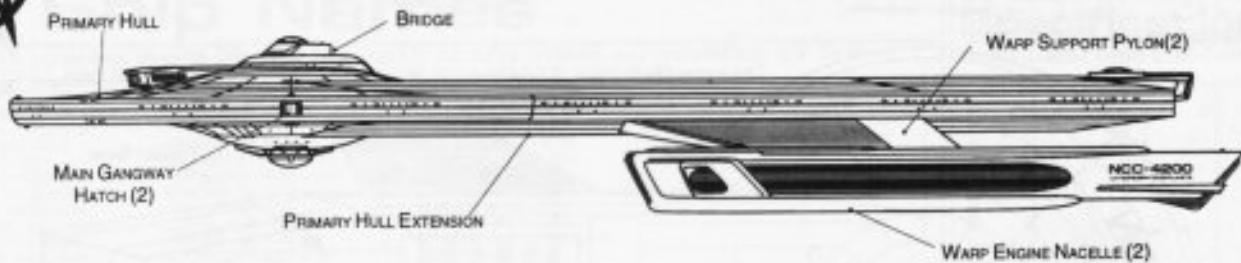

PORT PROFILE

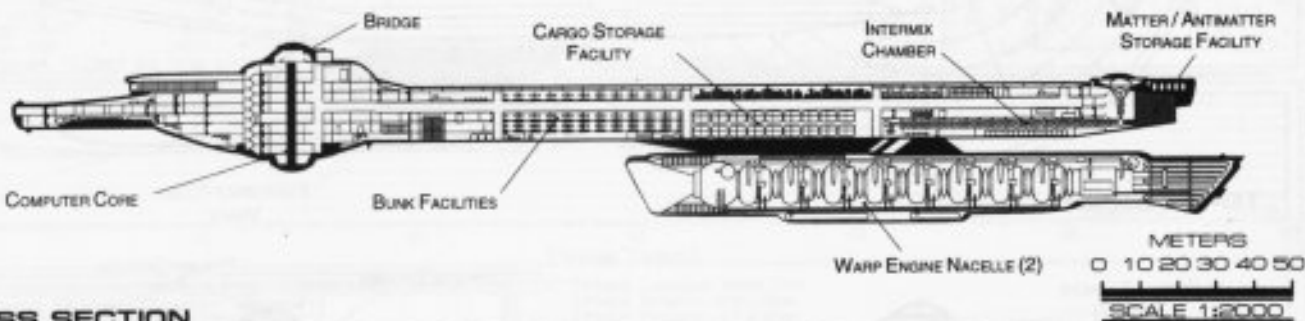

CROSS SECTION

Statistics

Classification: Troop Transport
Category: Assault Ship
Class: Trojan
Type: Class 1
Model: MK-XXVII
Naval Construction Contract: 4200
Number Proposed: 68
Number Constructed: 68
Number in Service: 66
Number Lost: 2
Dimensions:
Overall Dimensions (Meters)
 Length: 310.40m
 Width: 141.72m
 Height: 44.74m
Primary Hull Dimensions (Meters)
 Length: 297.70m
 Width: 141.72m
 Height: 32.94m
Secondary Hull Dimensions (Meters)
 Length: N/A
 Width: N/A
 Height: N/A
Warp Unit Dimensions (Meters)
 Length: 154.81m
 Width: 12.63m
 Height: 18.32m
Displacement (Metric Tons)
 Light: 229,385mt
 Standard: 245,760mt
 Full Load: 274,346mt
Performance:
Impulse Units: Dual Unit (IP185E/7-VE)
Impulse Engine Output: 7.8×10^{13} W
Impulse Power Index: 0.80
Max Cruising: C
Acceleration Rate:
 0.00-0.25 Impulse: 0.249 sec.
 0.25-0.50 Impulse: 0.373 sec.
 0.50-0.75 Impulse: 0.498 sec.
 0.75-Full Impulse: 0.622 sec.
Warp Units: 2 Nacelle Units (SW52/1-5GY)
Warp Engine Output: 1.2×10^{15} W
Warp Power Index: 0.800

Optimum Speed: Warp 4
Max. Safe Cruising: Warp 6
Emergency Speed: Warp 7.8
Max. Speed: Warp 8.8
Destructive Speed: Warp 9.05
Acceleration Power: 3.0
Acceleration Times:
 Warp 1 - Warp 2: 0.249 sec.
 Warp 2 - Warp 3: 0.298 sec.
 Warp 3 - Warp 4: 1.505 sec.
 Warp 4 - Warp 5: 2.165 sec.
 Warp 5 - Warp 6: 2.314 sec.
 Warp 6 - Warp 7: 2.501 sec.
 Warp 7 - Warp 8: 3.210 sec.
 Warp 8 - Warp 9: 4.591 sec.
 Warp 9 - Warp 9.5: 10.201 sec.
 Warp 9.5 - Warp 9.75: 11.189 sec.
 Warp 9.75 - Warp 9.9: 24.508 sec.
Duration (Years)
 Standard: 5 Years
 Maximum: 20 Years
Std. Ships Complement: 1200
Officers: 34
Crew (Ensign Grade): 166
Troops: 1000
Passengers: 60
Emergency condition: +500
Medical Facilities:
 Doctors: 7
 Nurses: 37
 Operating Rooms: 5
 Beds: 37
Laboratories: 7
Transporters Total: 16
 1 Person: 0
 2 Person: 0
 6 Person: 6
 12 Person: 0
 22 Person: 8
 Small Cargo: 2
 Medium Cargo: 1
 Large Cargo: 0
 Super Cargo: 0

Brigs: 28
Replicators: 19
Tractor Beams: 1
Tow Capacity: 2.81×10^6 mt
Max Range: 9.82×10^4 km
Cargo Specification:
 Standard Cargo Units: 341
 Cargo Capacity: 17,050mt
Shuttlecraft Specifications:
 Docking Ports: 3
Shuttlecraft Bays Total: 2
 Small Bay: 0
 Medium Bay: 2
 Large Bay: 0
 Super Bay: 0
Shuttlecraft Standard: 78
Work Bees: 3
Travel Pods: 3
Aquatic Shuttle: 1
Light Shuttle: 2
Standard Shuttle: 7
Heavy Shuttle: 2
Cargo Shuttle: 2
Assault Shuttle: 37
Killer Bees: 6
Fighter: 9
Heavy Fighter: 6
Lifeboats: 83
 Turbolift (8 person): 23
 Lifeboat (10 person): 41
 Lifeboat (20 person): 17
 Lifeboat (30 person): 1
Cloaking Devices: 0
Sensor Index Values:
 Planetary Survey: 0.9307
 Stellar Survey: 0.7690
Short Range: 1.2356
Long Range: 1.0210
Navigation: 1.2086
Special: 1.2286
Computers: 2
 Type: Daystrom Duotronic III:1
 Type: Daystrom Duotronic II:1

ECM Index: 1.28
Shield Rating:
Shield Index: 0.80
Holdoff Power: 3.22×10^{12} W
Refresh Rate: 9.15×10^{11} W
Breakdown Rate: 1.10×10^{12} W
Shield Dimensions (Meters)
 Length: 302.09m
 Width: 177.01m
 Height: 56.91m
Weapons:
Phaser Power Index: 0.447
Photon Power Index: 1.29
Vessel Power Index: 0.87
Weapon Placement:
Beam (Phasers) Total: 9 banks 2 each
 Output: 5.0×10^{11} W / 2.5×10^{11} W
 Range: 2.5×10^5 km
 Rate of Fire: 30 ppm / Cont.
Forward Banks: 1
Rear Banks: 0
Port Banks: 2
Starboard Banks: 2
Upper Banks: 2
Lower Banks: 2
Beam (MegaPhasers) Total: 0
 Output: N/A
 Range: N/A
 Rate of Fire: N/A
Forward/Rear Banks: 0
Port/Starboard Banks: 0
Upper/Lower Banks: 0
Torpedoes (Photon) Total: 1 Bay 2 each
 Stock: 40
 Range: 2.0×10^5 km
 Output: 10-50 Megatons
Rate of Fire: 10 spm
Forward Bay: 1
Rear Bay: 0
Port Bay: 0
Starboard Bay: 0
Upper Bay: 0
Lower Bay: 0

TROOP TRANSPORT



TROJAN CLASS

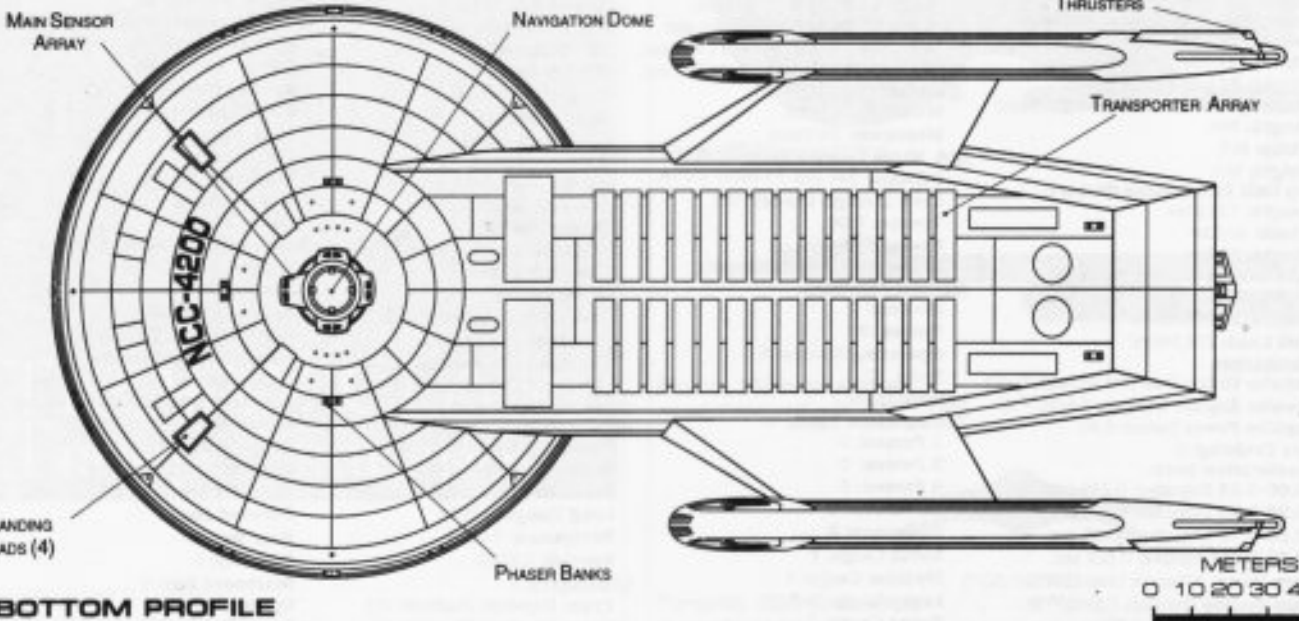
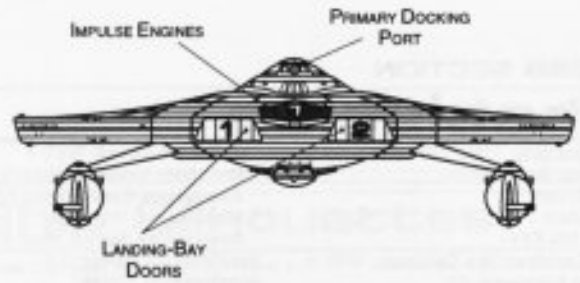
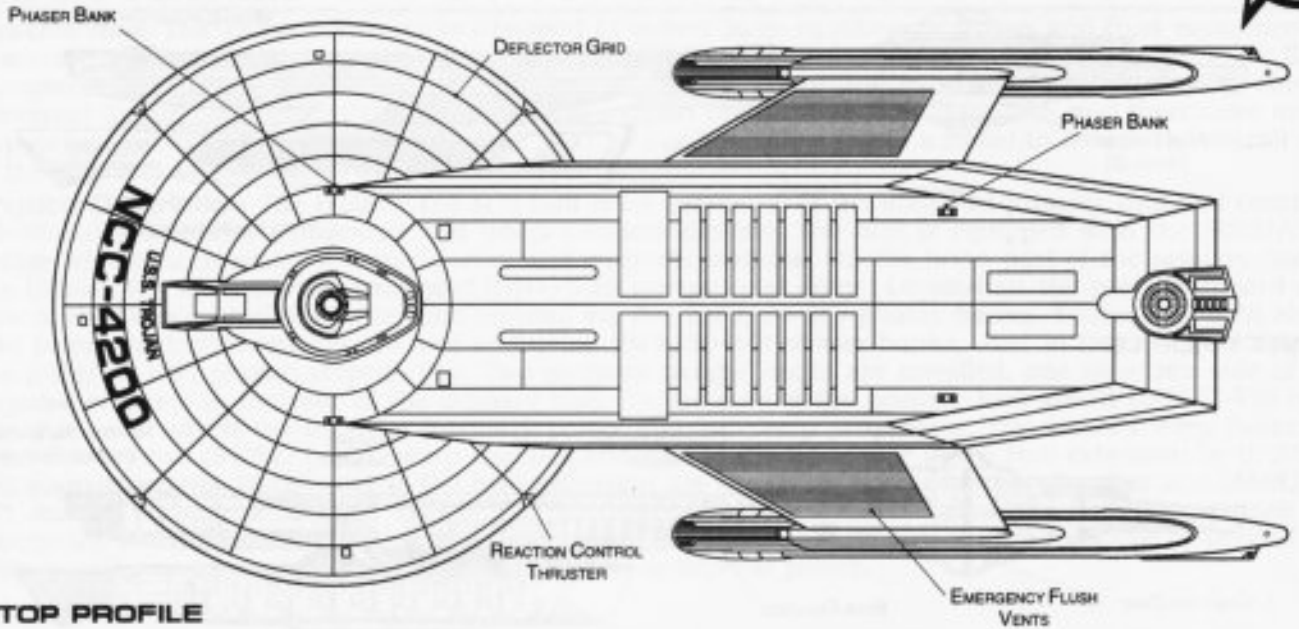

METERS
0 10 20 30 40 50
SCALE 1:2000

FEDERATION VESSEL



TROOP TRANSPORT

Ship Names

THE FOLLOWING SHIPS OF THE MK-XXVII CLASS WERE AUTHORIZED BY THE AMENDED ARTICLES OF FEDERATION OF STARDATE 2270.4

AALBERS *NCC-4267	GRAFFTT *NCC-4244	PADGETT *NCC-4228
ABERCROMBIE *NCC-4290	GRUBEN *NCC-4235	PELLETTE *NCC-4257
ADDINGTON *NCC-4233	GUYER *NCC-4222	PORTER *NCC-4211
ALDMAR *NCC-4210	HAGENS *NCC-4248	PULLIAM *NCC-4216
AUTRY *NCC-4221	HALLMARK *NCC-4265	RABJOHN *NCC-4225
AVANT *NCC-4226	HANDFORD *NCC-4258	RHYNE *NCC-4213
AYLLOONN *NCC-4260	JENKINS *NCC-4236	SEGER *NCC-4259
BADGWELL *NCC-4254	JOBE *NCC-4253	SLYKER *NCC-4229
BARRINGTON *NCC-4215	JUDAH *NCC-4205	SOVELL *NCC-4232
BEECHAM *NCC-4203	KARLAN *NCC-4212	STRICKLAND *NCC-4218
BERTREAU *NCC-4241	KEATHLEY *NCC-4220	TABOR *NCC-4223
BINDER *NCC-4264	KIESLING *NCC-4263	THIEBUAD *NCC-4255
BOCANEGER *NCC-4206	LACEWELL *NCC-4224	TILLERY *NCC-4242
CALLAMATEO *NCC-4217	LEWIS *NCC-4243	TROJAN *NCC-4200*
CARDWELL *NCC-4239	LINTON *NCC-4256	TURMAN *NCC-4214**
COULTER *NCC-4246	MAINORD *NCC-4208	VANOVER *NCC-4240
DALRYMPLE *NCC-4230	MAZARATTI *NCC-4219	WARDRIIP *NCC-4251**
DEARMOND *NCC-4201	MELTON *NCC-4234	ZOBAC *NCC-4249
EDWARDS *NCC-4202	MORAN *NCC-4262	
EVANSEN *NCC-4209	NGUYAN *NCC-4207	
FABER *NCC-4204	NICHOLAS *NCC-4227	
FLOREN *NCC-4231	NORRELL *NCC-4237	
FURLOUGH *NCC-4238	OLLISON *NCC-4245	
GADISON *NCC-4247	OSBORN *NCC-4261	
GIVEON *NCC-4266	OVERLY *NCC-4252	

*CLASS SHIP, **LOST IN THE LINE OF DUTY, ***PROPOSED. ALL NAMES PRECEDED WITH "U.S.S."

Tractor Beam Specifications

Primary Tractor Beam Load Calculator

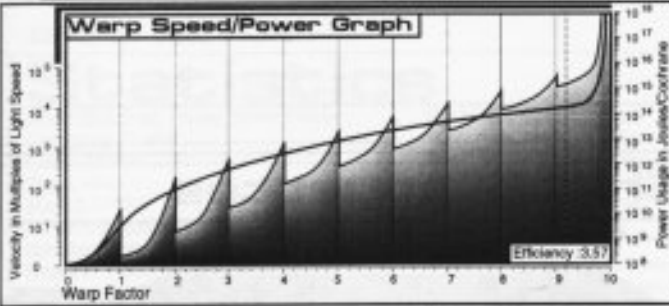
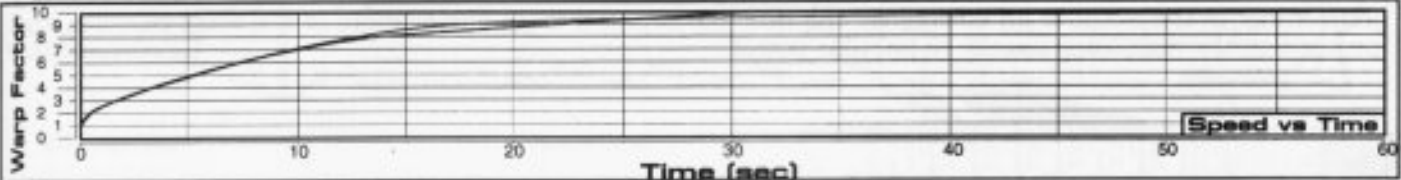
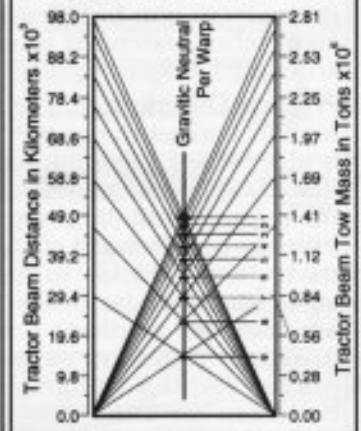

Field Length 826.7m
Field Width 230.8m
Field Height 112.2m



Front Warp Field Profile
Cross Section Area 18142.00 m²



Port Warp Field Profile
Cross Section Area 48594.08 m²

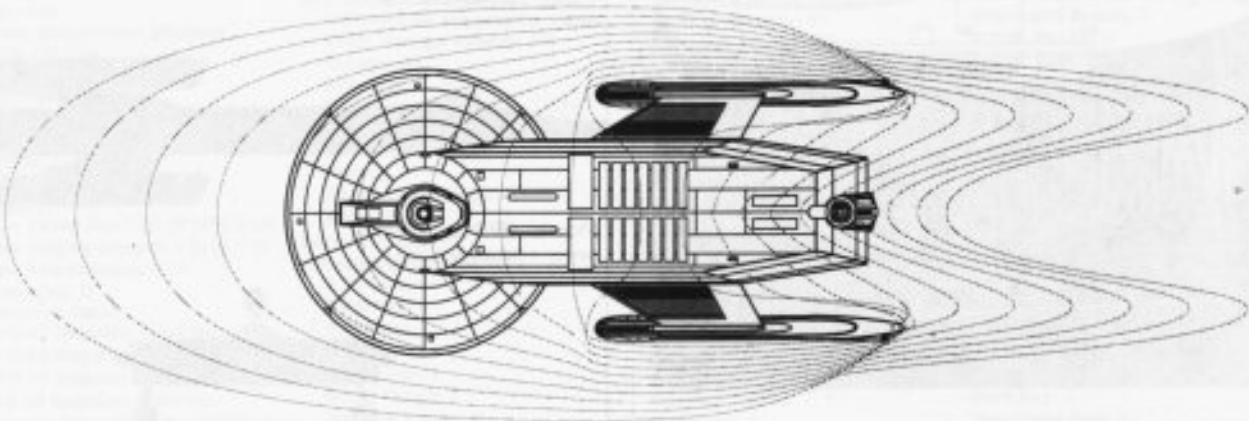

Top Warp Field Profile
Cross Section Area 100920.00 m²

WARP FIELDS

TROJAN CLASS

FEDERATION VESSEL

HEAVY SHUTTLE CARRIER



DAKOTA CLASS

General Information

Specific Role: The Heavy Shuttlecraft Carrier is designed to be a support ship for a variety of shuttlecraft, generally in non-hostile and rear support areas. The Heavy Shuttlecraft Carrier is based on the Frigate with a stretched, extended primary hull with multiple hangar decks located along the perimeter of the extended section.

Physical Description: The (PHE147/SC-T2) hull is an extension of the standard primary hull. The extended section houses the carrier's light craft support systems. The primary hull is equipped with a (BS9/SC-T1) bridge which incorporates an advanced tracking station. On the lower part of the primary hull is the (SM49/3Y) main sensor array and (DN4/3-U) navigational dome. Located on the port, starboard and bow of the primary hull (both top and bottom) are six (BP2/30-2C) phaser banks. Port and starboard on the upper primary hull forward of the raised extension, are the (DN2/G-4.2) navigational deflectors used to assist the navigational shields in deflecting oncoming debris. Along the perimeter of the hull extension are twenty eight small hangar decks. To the rear of the primary hull are two (IP186E/9-DI) dual impulse units which are used for auxiliary power and sub-warp propulsion. The carrier's warp fields are generated by three (SW52/1-5LO) warp nacelles, two are attached to the underside of the primary hull by (DU/25-7F) support pylons, the third is attached to the top by a dorsal (DU/29-8S) support pylon. In the rear of the hull extension are the (M28/4-2F) intermix chamber and (AM8/48-4R) matter/antimatter storage tanks. The storage tanks are located on the bottom of the hull just forward of the lower impulse engines for emergency jettisoning. In the event of an emergency the hull can separate from one or more of the warp nacelles and proceed on the remaining nacelle or impulse power.

Class Emblem

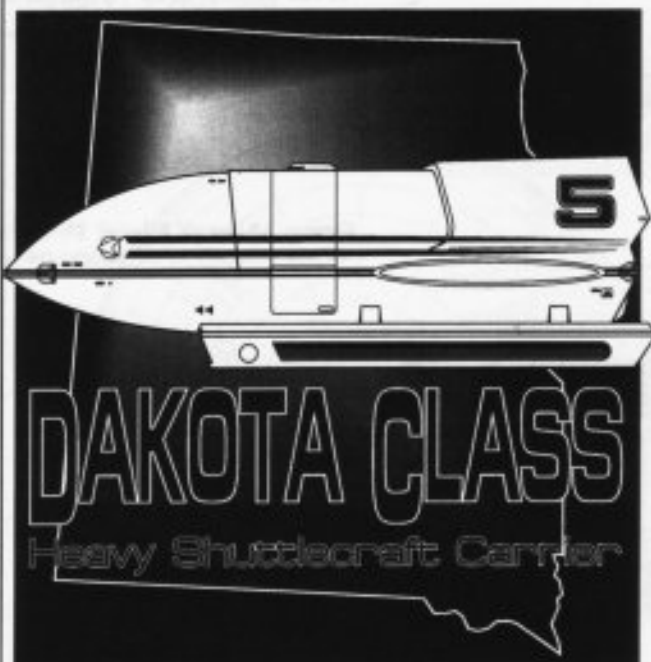

Ship Silhouettes

Total Target Area 65243.56 m²



Top Silhouette
Area 47464.64 m²



Port Silhouette
Area 13934.40 m²



Front Silhouette
Area 3844.52 m²

FEDERATION VESSEL

HEAVY SHUTTLE CARRIER

DAKOTA CLASS

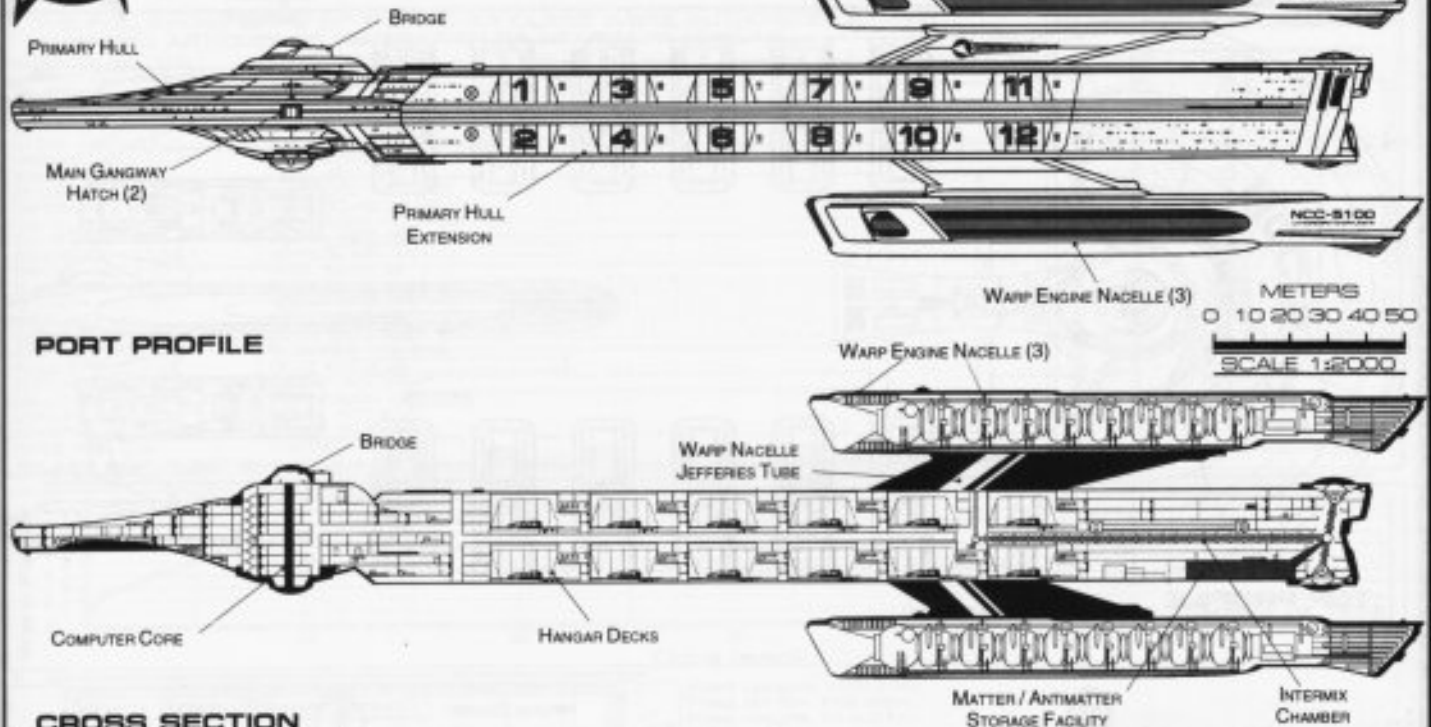

PORT PROFILE

CROSS SECTION

Statistics

Classification: Heavy Shuttle Carrier

Category: Carrier

Class: Dakota

Type: Class 1

Model: MK-XX

Naval Construction Contract: 5100

Number Proposed: 56

Number Constructed: 56

Number in Service: 54

Number Lost: 2

Dimensions:

Overall Dimensions (Meters)

Length: 355.71m

Width: 141.72m

Height: 72.85m

Primary Hull Dimensions (Meters)

Length: 343.40m

Width: 141.72m

Height: 32.94m

Secondary Hull Dimensions (Meters)

Length: N/A

Width: N/A

Height: N/A

Warp Unit Dimensions (Meters)

Length: 154.81m

Width: 12.63m

Height: 18.32m

Displacement (Metric Tons)

Light: 314,839mt

Standard: 337,314mt

Full Load: 376,550mt

Performance:

Impulse Units: Dual Unit (IP186E/9-DI)

Impulse Engine Output: 7.8×10^{13} W

Impulse Power Index: 0.59

Max Cruising: C

Acceleration Rate:

0.00-0.25 Impulse: 0.342 sec.

0.25-0.50 Impulse: 0.512 sec.

0.50-0.75 Impulse: 0.683 sec.

0.75-Full Impulse: 0.854 sec.

Warp Units: 3 Nacelle Units (SW52/1-SLO)

Warp Engine Output: 1.2×10^{15} W

Warp Power Index: 0.880

Optimum Speed: Warp 4

Max. Safe Cruising: Warp 6

Emergency Speed: Warp 8

Max. Speed: Warp 8.8

Destructive Speed: Warp 9

Acceleration Power: 3.0

Acceleration Times:

Warp 1 - Warp 2: 0.228 sec.

Warp 2 - Warp 3: 0.364 sec.

Warp 3 - Warp 4: 1.377 sec.

Warp 4 - Warp 5: 1.981 sec.

Warp 5 - Warp 6: 2.117 sec.

Warp 6 - Warp 7: 2.288 sec.

Warp 7 - Warp 8: 2.937 sec.

Warp 8 - Warp 9: 4.201 sec.

Warp 9 - Warp 9.5: 9.335 sec.

Warp 9.5 - Warp 9.75: 10.814 sec.

Warp 9.75 - Warp 9.9: 22.426 sec.

Duration (Years)

Standard: 6 Years

Maximum: 24 Years

Std. Ships Complement: 425

Officers: 62

Crew (Ensign Grade): 302

Troops: 61

Passengers: 85

Emergency condition: +571

Medical Facilities:

Doctors: 5

Nurses: 26

Operating Rooms: 4

Beds: 26

Laboratories: 14

Transporters Total: 12

1 Person: 0

2 Person: 0

6 Person: 4

12 Person: 0

22 Person: 4

Small Cargo: 2

Medium Cargo: 2

Large Cargo: 0

Super Cargo: 0

Brigs: 23

Replicators: 28

Tractor Beams: 1

Tow Capacity: 5.53×10^6 mt

Max Range: 1.50×10^5 km

Cargo Specification:

Standard Cargo Units: 468

Cargo Capacity: 23,400mt

Shuttlecraft Specifications:

Docking Ports: 5

Shuttlecraft Bays Total: 28

Small Bay: 28

Medium Bay: 0

Large Bay: 0

Super Bay: 0

Shuttlecraft Standard: 257

Work Bees: 17

Travel Pods: 20

Aquatic Shuttle: 0

Light Shuttle: 20

Standard Shuttle: 15

Heavy Shuttle: 20

Cargo Shuttle: 17

Assault Shuttle: 61

Killer Bees: 29

Fighter: 29

Heavy Fighter: 29

Lifeboats: 45

Turbolift (8 person): 23

Lifeboat (10 person): 15

Lifeboat (20 person): 6

Lifeboat (30 person): 0

Cloaking Devices: 0

Sensor Index Values:

Planetary Survey: 0.8928

Stellar Survey: 0.8627

Short Range: 0.9041

Long Range: 0.8756

Navigation: 1.0002

Special: 0.6929

Computers: 2

Type: Daystrom Duotronic III:u

Type: Daystrom Duotronic II:l

ECM Index: 0.980

Shield Rating:

Shield Index: 0.59

Holdoff Power: 3.24×10^{12} W

Refresh Rate: 9.20×10^{11} W

Breakdown Rate: 1.10×10^{12} W

Shield Dimensions (Meters)

Length: 449.32m

Width: 177.01m

Height: 92.03m

Weapons:

Phaser Power Index: 0.390

Photon Power Index: 0.0

Vessel Power Index: 0.20

Weapon Placement:

Beam (Phasers) Total: 6 banks 2 each

Output: 5.0×10^{11} W / 2.5×10^{11} W

Range: 2.5×10^5 km

Rate of Fire: 30 ppm / Cont.

Forward Banks: 2

Rear Banks: 0

Port Banks: 2

Starboard Banks: 2

Upper Banks: 0

Lower Banks: 0

Beam (MegaPhasers) Total: 0

Output: N/A

Range: N/A

Rate of Fire: N/A

Forward/Rear Banks: 0

Port/Starboard Banks: 0

Upper/Lower Banks: 0

Torpedoes (Photon) Total: N/A

Stock: N/A

Range: N/A

Output: N/A

Rate of Fire: N/A

Forward Bay: 0

Rear Bay: 0

Port Bay: 0

Starboard Bay: 0

Upper Bay: 0

Lower Bay: 0

FEDERATION VESSEL

HEAVY SHUTTLE CARRIER



DAKOTA CLASS

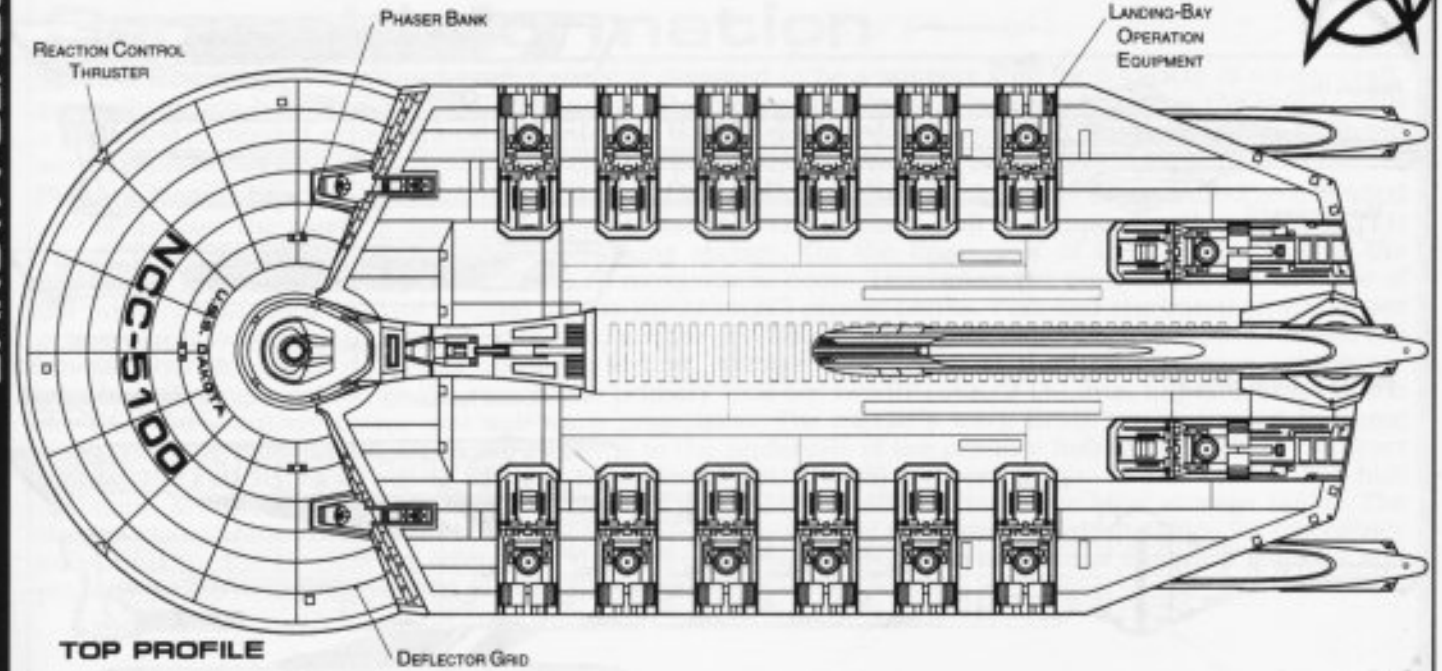

TOP PROFILE

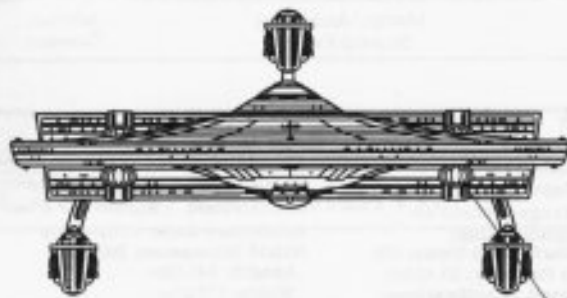

FRONT PROFILE

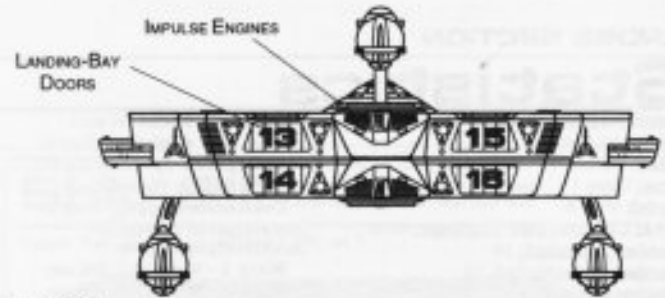

REAR PROFILE

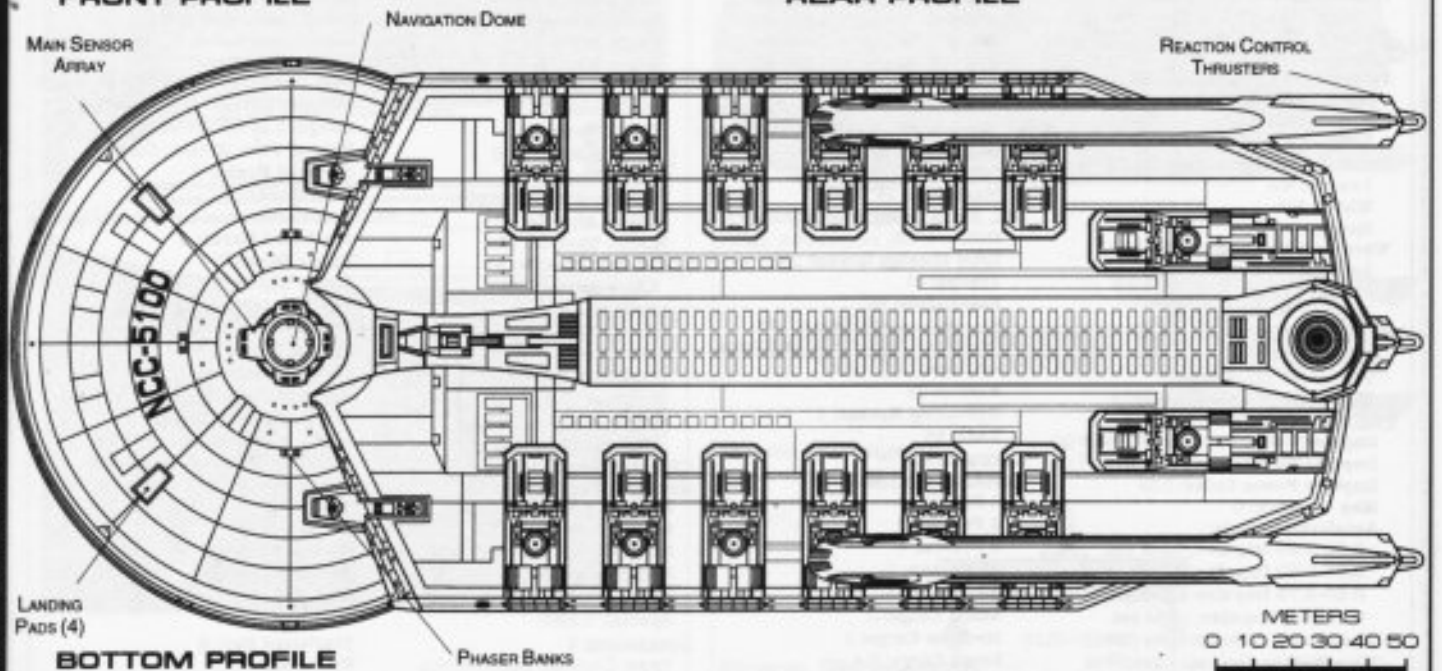

BOTTOM PROFILE

METERS
0 10 20 30 40 50
SCALE 1:2000

FEDERATION VESSEL

HEAVY SHUTTLE CARRIER



Ship Names

THE FOLLOWING SHIPS OF THE MK-XX CLASS WERE AUTHORIZED BY THE AMENDED ARTICLES OF FEDERATION OF STARDATE 2269.12

- | | | |
|-----------------------|--------------------------|---------------------|
| ALDERSON *NCC-5130 | INKMAN *NCC-5143 | REITTER *NCC-5147 |
| ANNEYA *NCC-5145 | JACKSON *NCC-5152 | SALCIDO *NCC-5110 |
| ARMSTRONG *NCC-5106 | JUNDT *NCC-5107 | SLABOTSKY *NCC-5133 |
| ARNETT *NCC-5155 | KASTMANN *NCC-5122 | TASILLO *NCC-5113 |
| ATCHINSON *NCC-5118 | KEMPER *NCC-5142 | WASHBURN *NCC-5120 |
| AYERS *NCC-5137 | KINGSBERRY *NCC-5129 | ZAPATA *NCC-5146 |
| BABOYEC *NCC-5111** | KUBALA *NCC-5101 | |
| BALLIE *NCC-5134 | LAIRD *NCC-5102 | |
| BEALER *NCC-5124 | LANGGOOD *NCC-5128 | |
| CARMICHAEL *NCC-5151 | LUCEROO *NCC-5136 | |
| CASTILLO *NCC-5103 | MUPHERSON *NCC-5135 | |
| COATES *NCC-5115 | MEMON *NCC-5105 | |
| COGGBURN *NCC-5141 | MONROE *NCC-5126 | |
| DAKOTA *NCC-5100* | NEES *NCC-5139 | |
| DAUGHTERY *NCC-5149 | NEUDORF *NCC-5148 | |
| DOCKERY *NCC-5127 | NORRIS *NCC-5117 | |
| DUFF *NCC-5121 | NUTT *NCC-5125 | |
| EILENBERGER *NCC-5108 | OCHSENSCHLAGER *NCC-5140 | |
| ETCHISON *NCC-5150 | OLTMANN *NCC-5109 | |
| FEAGLEY *NCC-5123 | ORTIZ *NCC-5132 | |
| FLETCHER *NCC-5154 | PALTAN *NCC-5144** | |
| GALLENDO *NCC-5104 | PICKINPAUGH *NCC-5114 | |
| GOMOKE *NCC-5112 | POMPA *NCC-5131 | |
| HENSHALL *NCC-5153 | RAINEY *NCC-5138 | |
| HINDS *NCC-5116 | REDDINGTON *NCC-5119 | |

*CLASS SHIP, **LOST IN THE LINE OF DUTY, ***PROPOSED. ALL NAMES PRECEDED WITH "U.S.S."

Tractor Beam Specifications

Primary Tractor Beam Load Calculator

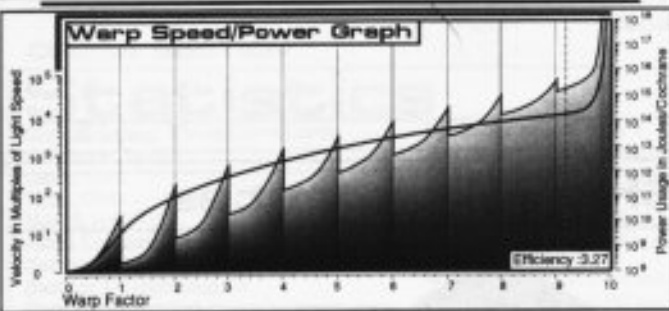
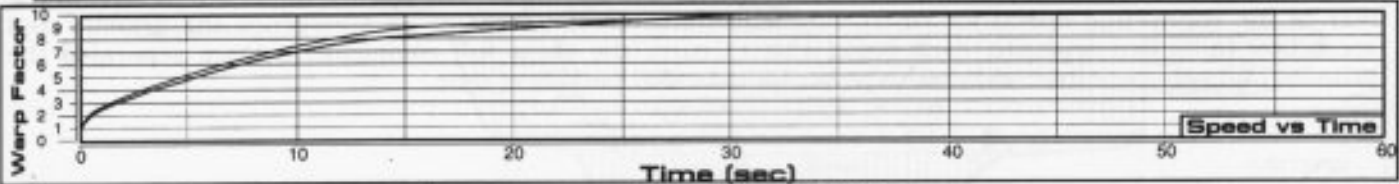
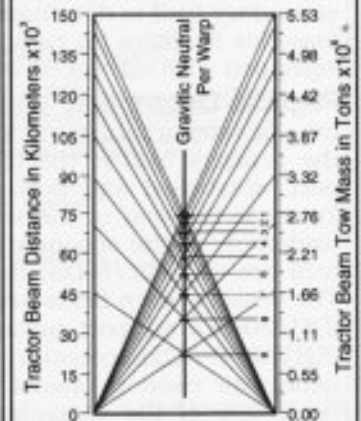

Field Length 708.10m
Field Width 192.92m
Field Height 114.31m

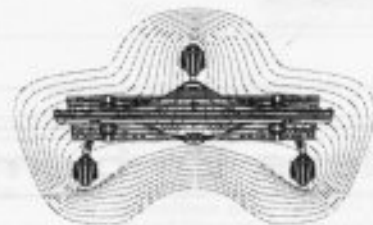

Front Warp Field Profile
Cross Section Area 15326.40 m²

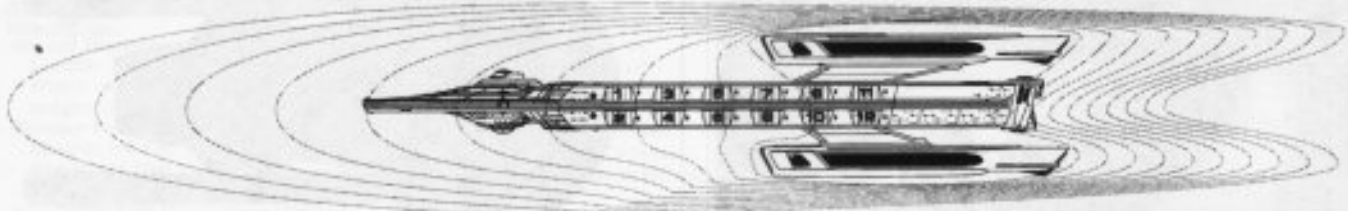

Port Warp Field Profile
Cross Section Area 64293.16 m²

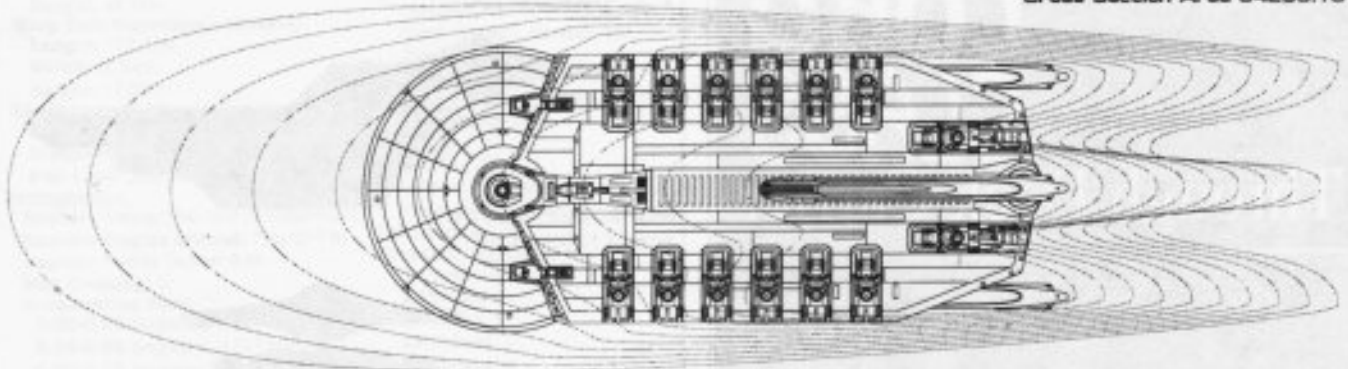

Top Warp Field Profile
Cross Section Area 110580.16 m²

WARP FIELDS

SRM2 04:03:01:04

STARFLEET REFERENCE MANUAL

DAKOTA CLASS

FEDERATION VESSEL

THROUGH DECK CARRIER



LOBO CLASS

General Information

Specific Role: The Through Deck Carrier is a heavy, frontline, fighter/shuttle delivery system. The enlarged secondary hull is dominated by multilevel hangar decks and small craft storage facilities. The through deck provides facilities for rapid recovery and turn-around of small craft during combat missions. The carrier is equipped with advanced warp nacelles since the standard nacelles are inadequate to propel the vessel.

Physical Description: The (PH147/SC-T4) primary hull is equipped with the (BS9/SC-T1) bridge which incorporates a larger tracking station as well as additional light craft support systems. On the lower part of the primary hull is the (SM49/7G) main sensor array and (DN4/9D) navigational dome. Located on the port, starboard and bow of the primary hull (both top and bottom) are six (BP2/30-2C) phaser banks. Towards the rear of the secondary hull above the hangar deck are two (BP2/30-2C) phaser banks. On the underside of the secondary hull are four additional (BP2/30-2C) phaser banks. To the rear of the primary hull are (IP186E/5-DS) dual impulse units which are used for auxiliary power and sub-warp propulsion. The vessel's warp fields are generated by two (SY71/1-5PN) warp nacelles attached to the secondary hull by (DU/20-6D) support pylons. Attached below the primary hull by a (DU/74-60V) connecting dorsal is the (SH182/C-SC2) secondary hull. On the forward edge of the secondary hull are four (DN4/A-3) navigational deflectors used to assist the navigational shields in deflecting oncoming debris. Located through the centerline of the secondary hull are independent hangar decks. Inside the dorsal is the (ND30/14-4T) intermix chamber and (AM8/48-5E) matter/antimatter storage tanks. The storage tanks are located in the rear of the connecting dorsal for emergency jettisoning. In the event of an emergency the primary and secondary hulls can separate; each being able to carry the ships full complement. Once separated the primary hull can maneuver on impulse power for extended periods of time.

Class Emblem

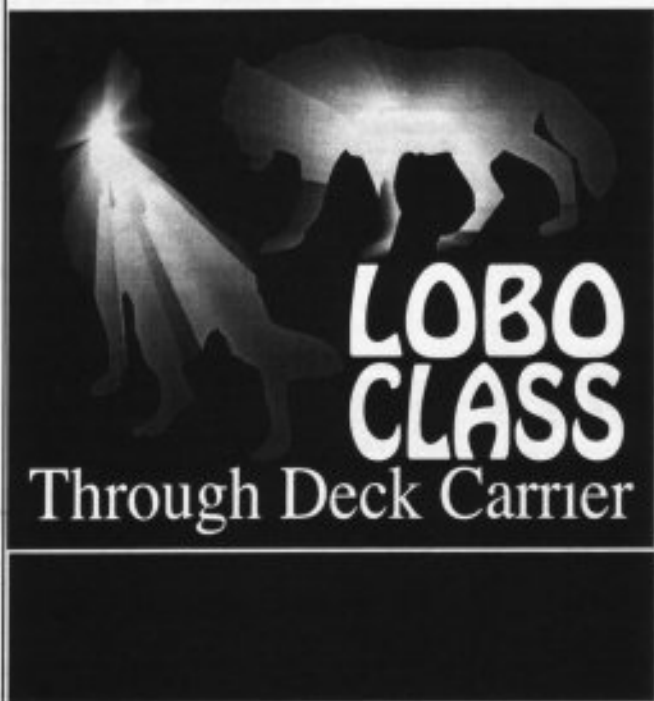

Ship Silhouettes

Total Target Area 50837.12 m²

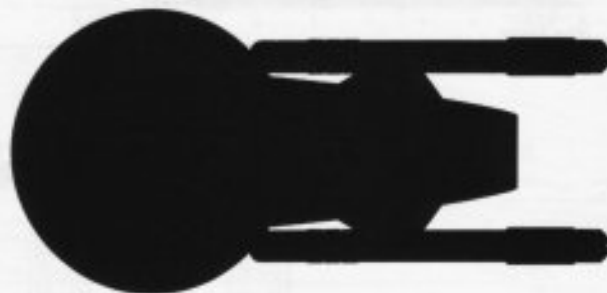

Top Silhouette
Area 32892.58 m²



Port Silhouette
Area 11703.84 m²



Front Silhouette
Area 6440.72 m²

FEDERATION VESSEL



THROUGH DECK CARRIER

LOBO CLASS

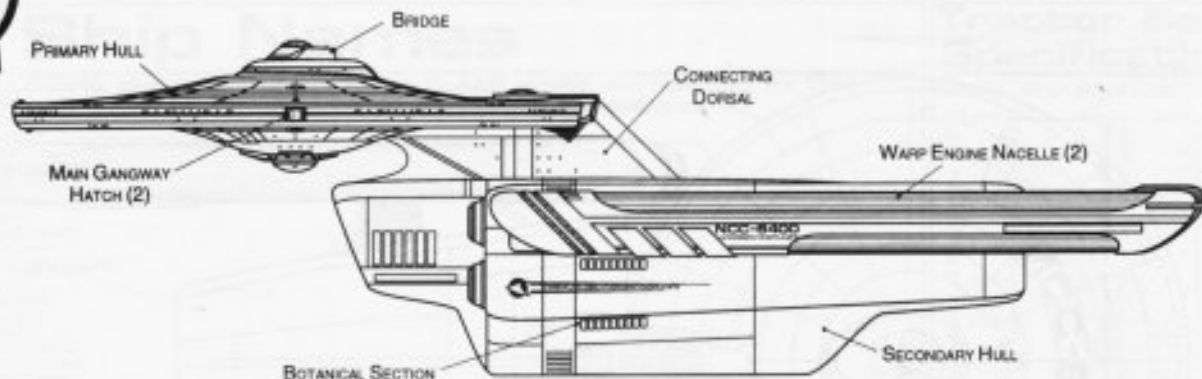

PORT PROFILE

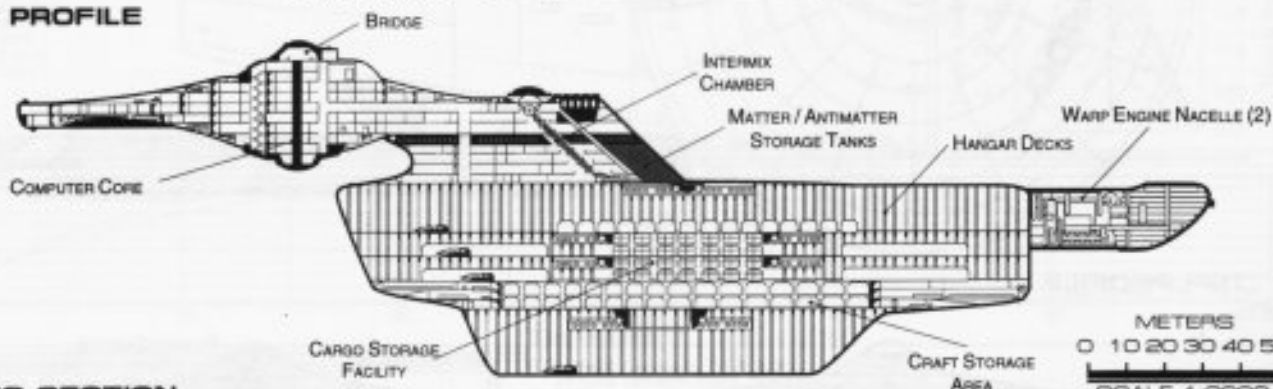

CROSS SECTION

Statistics

Classification: Through Deck Carrier

Category: Carrier

Class: Lobo

Type: Class 1

Model: MK-XXVIII

Naval Construction Contract: 6400

Number Proposed: 22

Number Constructed: 22

Number in Service: 21

Number Lost: 1

Dimensions:

Overall Dimensions (Meters)

Length: 300.58m

Width: 141.72m

Height: 83.61m

Primary Hull Dimensions (Meters)

Length: 146.31m

Width: 141.72m

Height: 32.94m

Secondary Hull Dimensions (Meters)

Length: 173.70m

Width: 77.64m

Height: 49.11m

Warp Unit Dimensions (Meters)

Length: 177.51m

Width: 26.84m

Height: 17.66m

Displacement (Metric Tons)

Light: 318,031mt

Standard: 340,734mt

Full Load: 380,368mt

Performance:

Impulse Units: Dual Unit (IP186E/5-DS)

Impulse Engine Output: 7.8×10^{13} W

Impulse Power Index: 0.58

Max Cruising: C

Acceleration Rate:

0.00-0.25 Impulse: 0.345 sec.

0.25-0.50 Impulse: 0.517 sec.

0.50-0.75 Impulse: 0.690 sec.

0.75-Full Impulse: 0.862sec.

Warp Units: 2 Nacelle Units (SY71/1-5PN)

Warp Engine Output: 2.16×10^{15} W

Warp Power Index: 1.040

Optimum Speed: Warp 4

Max. Safe Cruising: Warp 6

Emergency Speed: Warp 8

Max. Speed: Warp 9

Destructive Speed: Warp 9.15

Acceleration Power: 3.0

Acceleration Times:

Warp 1 - Warp 2: 0.192 sec.

Warp 2 - Warp 3: 0.307 sec.

Warp 3 - Warp 4: 1.159 sec.

Warp 4 - Warp 5: 1.667 sec.

Warp 5 - Warp 6: 1.782 sec.

Warp 6 - Warp 7: 1.926 sec.

Warp 7 - Warp 8: 2.472 sec.

Warp 8 - Warp 9: 3.536 sec.

Warp 9 - Warp 9.5: 7.858 sec.

Warp 9.5 - Warp 9.75: 9.103 sec.

Warp 9.75 - Warp 9.9: 18.878 sec.

Duration (Years)

Standard: 6 Years

Maximum: 24 Years

Std. Ships Complement: 425

Officers: 66

Crew (Ensign Grade): 322

Troops: 37

Passengers: 86

Emergency condition: +602

Medical Facilities:

Doctors: 5

Nurses: 25

Operating Rooms: 4

Beds: 25

Laboratories: 14

Transporters Total: 15

1 Person: 0

2 Person: 0

6 Person: 4

12 Person: 0

22 Person: 4

Small Cargo: 4

Medium Cargo: 3

Large Cargo: 0

Super Cargo: 0

Brigs: 23

Replicators: 26

Tractor Beams: 1

Tow Capacity: 5.92×10^6 mt

Max Range: 1.31×10^5 km

Cargo Specification:

Standard Cargo Units: 851

Cargo Capacity: 42,550mt

Shuttlecraft Specifications:

Docking Ports: 3

Shuttlecraft Bays Total: 4/4

Small Bay: 2/2

Medium Bay: 2/2

Large Bay: 0

Super Bay: 0

Shuttlecraft Standard: 95

Work Bees: 5

Travel Pods: 6

Aquatic Shuttle: 2

Light Shuttle: 4

Standard Shuttle: 8

Heavy Shuttle: 2

Cargo Shuttle: 3

Assault Shuttle: 9

Killer Bees: 10

Fighter: 20

Heavy Fighter: 20

Lifeboats: 37

Turbolift (8 person): 16

Lifeboat (10 person): 14

Lifeboat (20 person): 6

Lifeboat (30 person): 0

Cloaking Devices: 0

Sensor Index Values:

Planetary Survey: 0.8837

Stellar Survey: 0.8634

Short Range: 0.8951

Long Range: 0.8745

Navigation: 0.9708

Special: 1.7668

Computers: 2

Type: Daystrom Duotronic III:i

Type: Daystrom Duotronic II:p

ECM Index: 0.990

Shield Rating:

Shield Index: 0.56

Holdoff Power: 3.31×10^{12} W

Refresh Rate: 8.90×10^{11} W

Breakdown Rate: 1.07×10^{12} W

Shield Dimensions (Meters)

Length: 379.69m

Width: 177.01m

Height: 105.61m

Weapons:

Phaser Power Index: 0.515

Photon Power Index: 0.0

Vessel Power Index: 0.26

Weapon Placement:

Beam (Phasers) Total: 8 banks 2 each

Output: 5.0×10^{11} W / 2.5×10^{11} W

Range: 2.5×10^5 km

Rate of Fire: 30 ppm / Cont.

Forward Banks: 2

Rear Banks: 2

Port Banks: 2

Starboard Banks: 2

Upper Banks: 0

Lower Banks: 0

Beam (MegaPhasers) Total: 0

Output: N/A

Range: N/A

Rate of Fire: N/A

Forward/Rear Banks: 0

Port/Starboard Banks: 0

Upper/Lower Banks: 0

Torpedoes (Photon) Total: N/A

Stock: N/A

Range: N/A

Output: N/A

Rate of Fire: N/A

Forward Bay: 0

Rear Bay: 0

Port Bay: 0

Starboard Bay: 0

Upper Bay: 0

Lower Bay: 0

FEDERATION VESSEL

THROUGH DECK CARRIER



LOBO CLASS

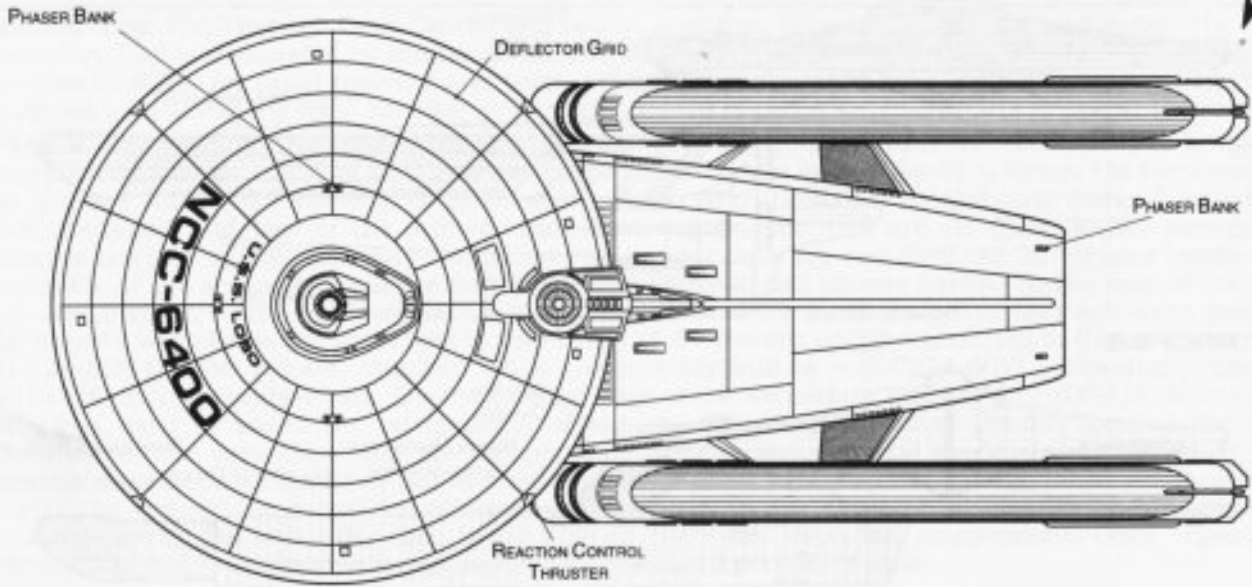

TOP PROFILE

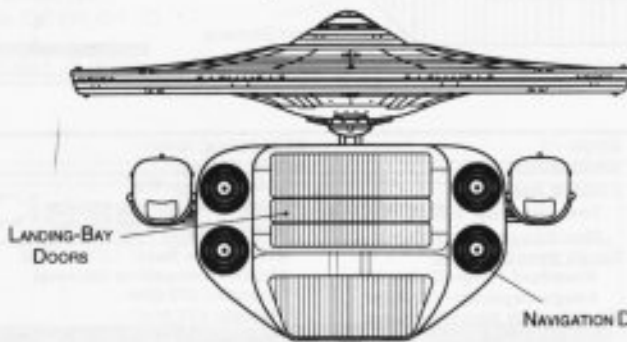

FRONT PROFILE

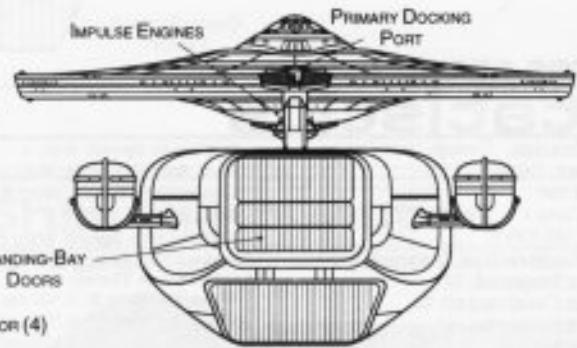

REAR PROFILE

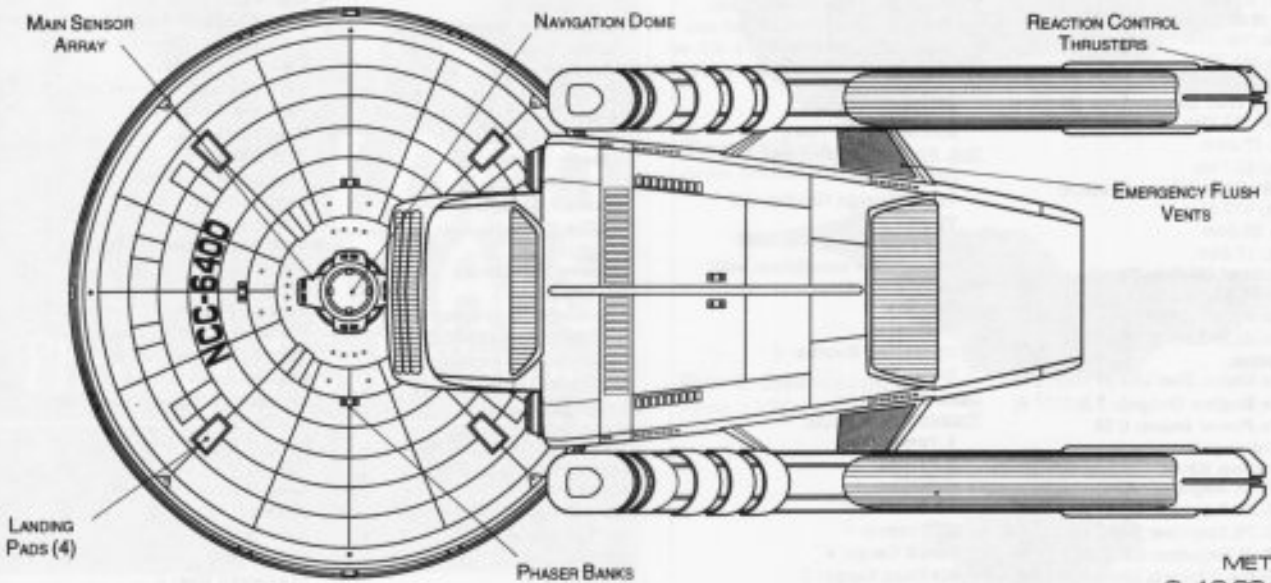

BOTTOM PROFILE

METERS
0 10 20 30 40 50
SCALE 1:2000

FEDERATION VESSEL



THROUGH DECK CARRIER

Ship Names

THE FOLLOWING SHIPS OF THE MK-XXVIII CLASS WERE AUTHORIZED BY THE AMENDED ARTICLES OF FEDERATION OF STARDATE 2274.9

- ALMEIDA *NCC-6405
- BOENAT *NCC-6412
- CRAWFLART *NCC-6418
- DUNCANARDY *NCC-6402
- ESQUIVEL *NCC-6416
- FURNEY *NCC-6421
- GRAHA *NCC-6407
- HENSONARD *NCC-6401
- HYLAND *NCC-6410*
- IRICK *NCC-6414
- JABOR *NCC-6403
- KUEBLER *NCC-6420
- LAMART *NCC-6409
- LOBO *NCC-6400*
- MASTERMAN *NCC-6419
- OMBRELLARO *NCC-6404
- PATSETER *NCC-6408
- QUINTERO *NCC-6411
- RICKELARD *NCC-6413
- SCIOLI *NCC-6406
- TEINERT *NCC-6415
- URTON *NCC-6417

*CLASS SHIP. *LOST IN THE LINE OF DUTY. **PROPOSED. ALL NAMES PRECEDED WITH "U.S.S."

Tractor Beam Specifications

Primary Tractor Beam Load Calculator

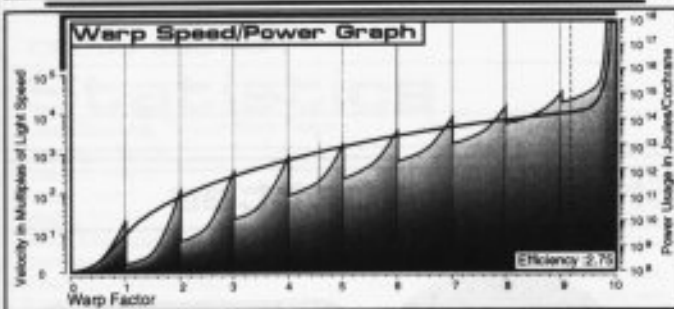
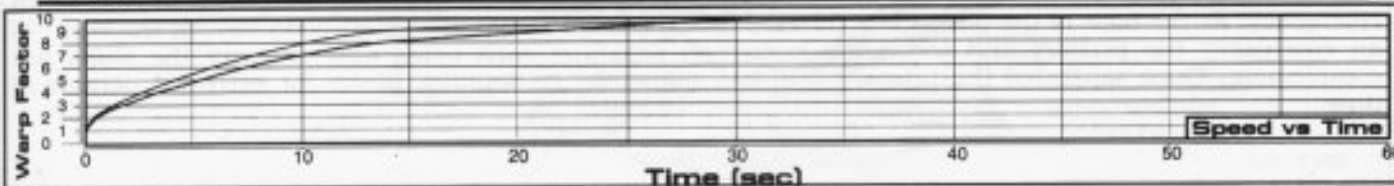
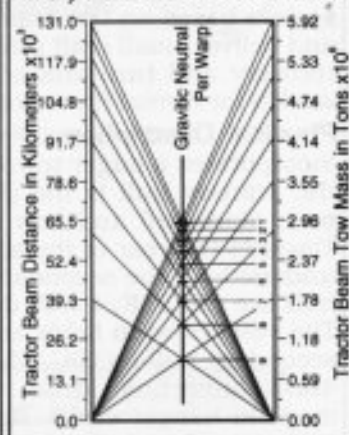

Field Length 712.34m
Field Width 229.30m
Field Height 112.22m

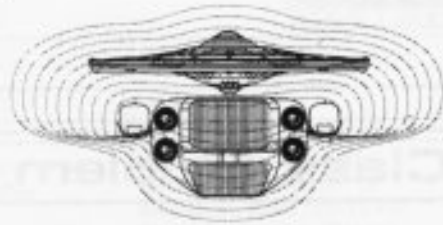

Front Warp Field Profile
Cross Section Area 17798.88 m²

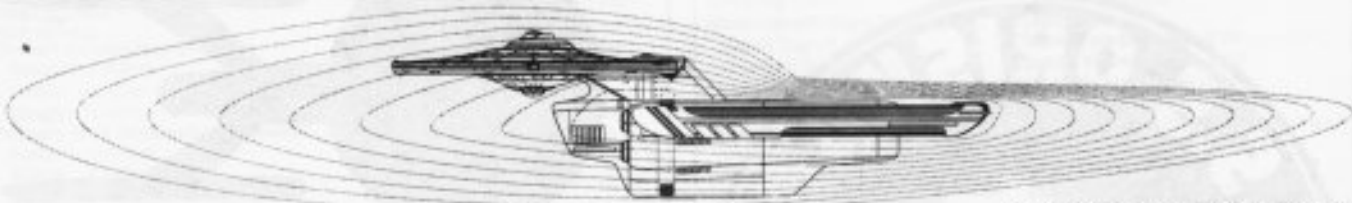

Port Warp Field Profile
Cross Section Area 50068.24 m²

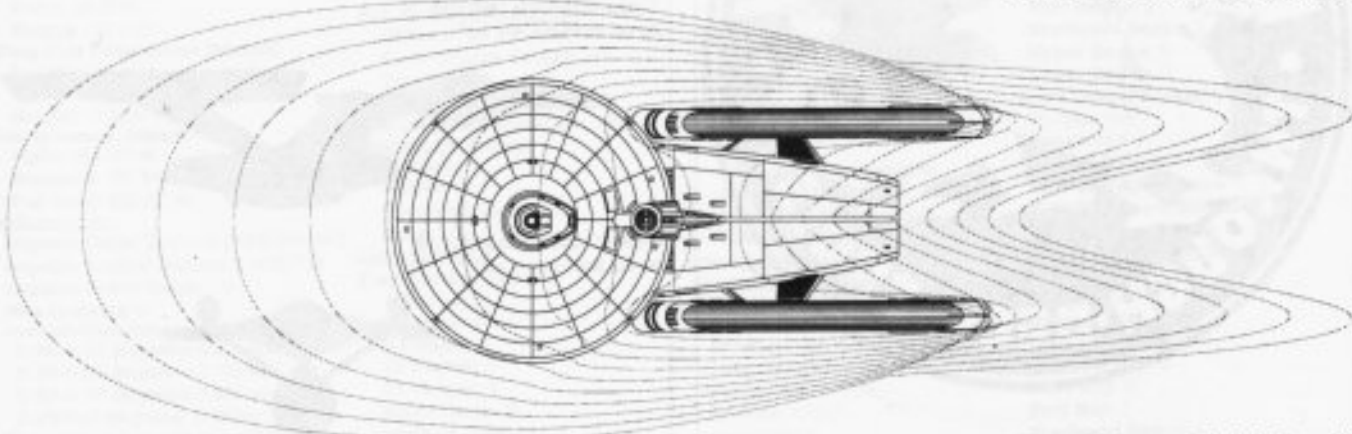

Top Warp Field Profile
Cross Section Area 117485.68 m²

WARP FIELDS

THROUGH DECK CRUISER



ORISKANY CLASS

General Information

Specific Role: The Through Deck Cruiser is a highly maneuverable, frontline, fighter/shuttle delivery system based on the Enterprise Class Heavy Cruiser. The vessel can perform on par with a Heavy Cruiser and deliver small craft directly into the action on the frontline. The through deck provides facilities for rapid recovery and turn-around of small craft during combat missions. These vessels are used to investigate worlds for formal first contact follow-up missions.

Physical Description: The (PH147/SC-T3) primary hull is equipped with the (BS9/SC-R2) bridge which incorporates a larger tracking station as well as additional light craft support systems. On the lower part of the primary hull is the (SM49/7E) main sensor array and (DN4/9B) navigational dome. Located on the port, starboard and bow of the primary hull (both top and bottom) are six (BP2/30-2C) phaser banks. Towards the rear of the secondary hull above the hangar deck are two (BP2/30-2C) phaser banks. On the underside of the secondary hull are four additional (BP2/30-2C) phaser banks. To the rear of the primary hull are (IRF35E/4-AW) dual impulse units which are used for auxiliary power and sub-warp propulsion. The vessel's warp fields are generated by two (SW52/1-5NV) warp nacelles attached to the (SH131/SC-C5) secondary hull by (DU/35-6G) support pylons. The primary and secondary hulls are joined by the (DU/50-48D) connecting dorsal. Located through the centerline of the secondary hull are the two connected medium hangar decks. Running through the dorsal is the (MD25/14-2R) intermix chamber. Inside upper rear secondary hull, the (AM8/36-4C) matter/antimatter storage tanks are easily jettisoned in case of an emergency. At the base of the dorsal is a forward facing (PB2/25-10F) photon torpedo bay. In the event of an emergency the primary and secondary hulls can separate; each being able to carry the ships full complement. Once separated the primary hull can maneuver on impulse power for extended periods of time.

Class Emblem



Ship Silhouettes

Total Target Area 38430.12 m²

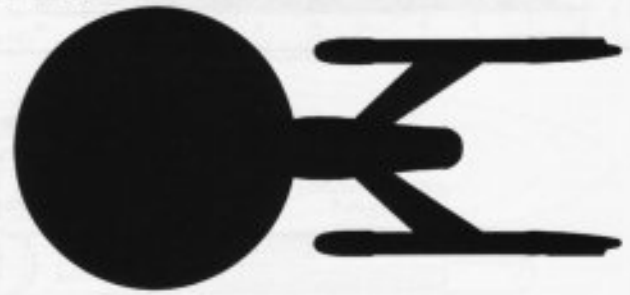

Top Silhouette
Area 25589.44 m²



Port Silhouette
Area 9218.24 m²



Front Silhouette
Area 3622.44 m²

FEDERATION VESSEL



THROUGH DECK CRUISER

ORISKANY CLASS

FEDERATION VESSEL

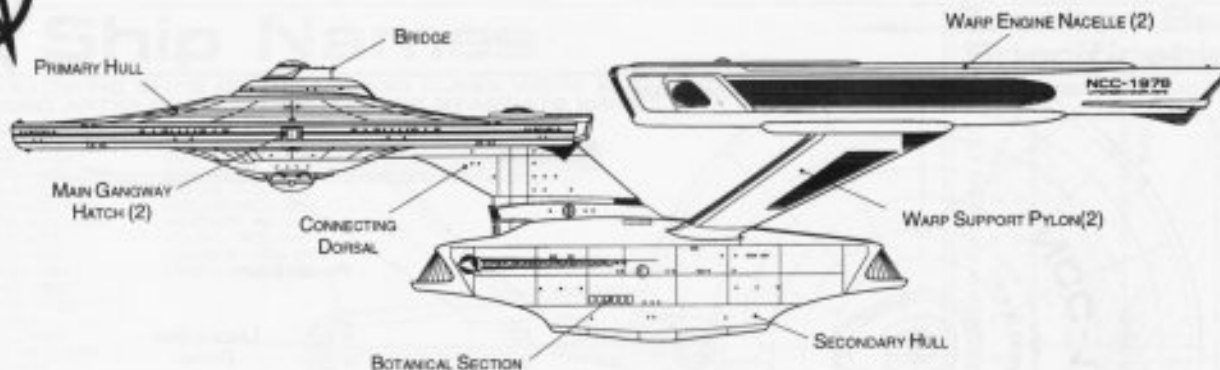

PORT PROFILE

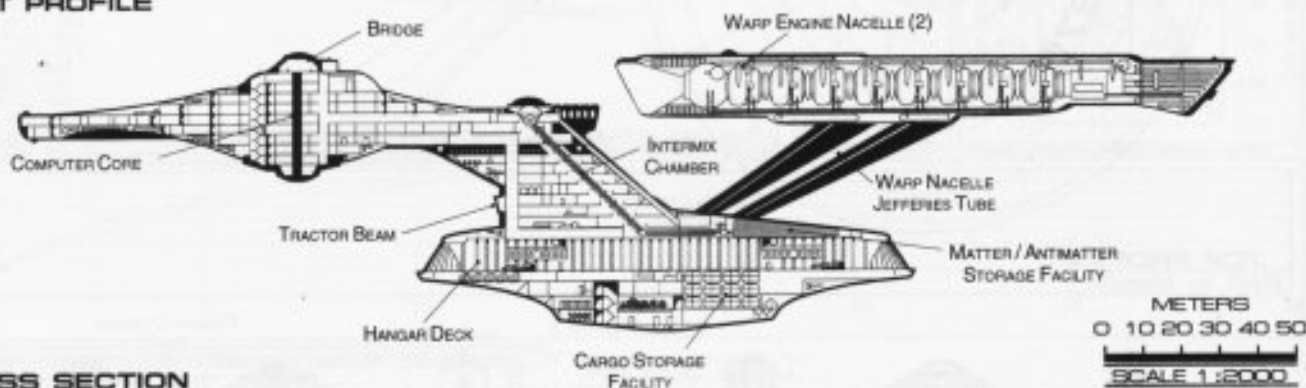

CROSS SECTION

Statistics

Classification: Through Deck Cruiser

Category: Carrier

Class: Oriskany

Type: Class 1

Model: MK-XXII

Naval Construction Contract: 1900

Number Proposed: 35

Number Constructed: 35

Number in Service: 34

Number Lost: 1

Dimensions:

Overall Dimensions (Meters)

Length: 304.80m

Width: 141.72m

Height: 70.47m

Primary Hull Dimensions (Meters)

Length: 146.31m

Width: 141.72m

Height: 32.94m

Secondary Hull Dimensions (Meters)

Length: 124.65m

Width: 31.21m

Height: 30.91m

Warp Unit Dimensions (Meters)

Length: 154.81m

Width: 12.63m

Height: 18.32m

Displacement (Metric Tons)

Light: 184,381mt

Standard: 197,543mt

Full Load: 220,521mt

Performance:

Impulse Units: Dual Unit (IRF35E/4-AW)

Impulse Engine Output: 7.8×10^{13} W

Impulse Power Index: 1.00

Max Cruising: C

Acceleration Rate:

0.00-0.25 Impulse: 0.200 sec.

0.25-0.50 Impulse: 0.300 sec.

0.50-0.75 Impulse: 0.400 sec.

0.75-Full Impulse: 0.500sec.

Warp Units: 2 Nacelle Units (SW52/1-5NV)

Warp Engine Output: 1.20×10^{15} W

Warp Power Index: 1.000

Optimum Speed: Warp 4

Max. Safe Cruising: Warp 6

Emergency Speed: Warp 8

Max. Speed: Warp 9.1

Destructive Speed: Warp 9.25

Acceleration Power: 3.0

Acceleration Times:

Warp 1 - Warp 2: 0.200 sec.

Warp 2 - Warp 3: 0.320 sec.

Warp 3 - Warp 4: 1.210 sec.

Warp 4 - Warp 5: 1.740 sec.

Warp 5 - Warp 6: 1.860 sec.

Warp 6 - Warp 7: 2.010 sec.

Warp 7 - Warp 8: 2.580 sec.

Warp 8 - Warp 9: 3.690 sec.

Warp 9 - Warp 9.5: 8.200 sec.

Warp 9.5 - Warp 9.75: 9.500 sec.

Warp 9.75 - Warp 9.9: 19.700 sec.

Duration (Years)

Standard: 5 Years

Maximum: 20 Years

Std. Ships Complement: 358

Officers: 56

Crew (Ensign Grade): 276

Troops: 26

Passengers: 50

Emergency condition: +486

Medical Facilities:

Doctors: 4

Nurses: 21

Operating Rooms: 3

Beds: 21

Laboratories: 8

Transporters Total: 9

1 Person: 0

2 Person: 0

6 Person: 3

12 Person: 0

22 Person: 3

Small Cargo: 2

Medium Cargo: 1

Large Cargo: 0

Super Cargo: 0

Brigs: 18

Replicators: 15

Tractor Beams: 1

Tow Capacity: 5.25×10^6 mt

Max Range: 1.15×10^5 km

Cargo Specification:

Standard Cargo Units: 376

Cargo Capacity: 18,800mt

Shuttlecraft Specifications:

Docking Ports: 3

Shuttlecraft Bays Total: 2

Small Bay: 0

Medium Bay: 2

Large Bay: 0

Super Bay: 0

Shuttlecraft Standard: 44

Work Bees: 3

Travel Pods: 2

Aquatic Shuttle: 2

Light Shuttle: 2

Standard Shuttle: 8

Heavy Shuttle: 2

Cargo Shuttle: 2

Assault Shuttle: 5

Killer Bees: 4

Fighter: 8

Heavy Fighter: 6

Lifeboats: 32

Turbolift (8 person): 16

Lifeboat (10 person): 11

Lifeboat (20 person): 4

Lifeboat (30 person): 1

Cloaking Devices: 0

Sensor Index Values:

Planetary Survey: 0.9670

Stellar Survey: 0.8608

Short Range: 0.934

Long Range: 0.8754

Navigation: 1.1198

Special: 1.9397

Computers: 2

Type: Daystrom Duotronic III:x

Type: Daystrom Duotronic II:b

ECM Index: 1.00

Shield Rating:

Shield Index: 0.98

Holdoff Power: 3.19×10^{12} W

Refresh Rate: 9.07×10^{11} W

Breakdown Rate: 1.09×10^{12} W

Shield Dimensions (Meters)

Length: 367.22m

Width: 177.01m

Height: 88.98m

Weapons:

Phaser Power Index: 0.78

Photon Power Index: 0.00

Vessel Power Index: 0.39

Weapon Placement:

Beam (Phasers) Total: 7 banks 2 each

Output: 5.0×10^{11} W / 2.5×10^{11} W

Range: 2.5×10^5 km

Rate of Fire: 30 ppm / Cont.

Forward Banks: 2

Rear Banks: 1

Port Banks: 2

Starboard Banks: 2

Upper Banks: 0

Lower Banks: 0

Beam (MegaPhasers) Total: 0

Output: N/A

Range: N/A

Rate of Fire: N/A

Forward/Rear Banks: 0

Port/Starboard Banks: 0

Upper/Lower Banks: 0

Torpedoes (Photon) Total: N/A

Stock: N/A

Range: N/A

Output: N/A

Rate of Fire: N/A

Forward Bay: 0

Rear Bay: 0

Port Bay: 0

Starboard Bay: 0

Upper Bay: 0

Lower Bay: 0

THROUGH DECK CRUISER



ORISKANY CLASS

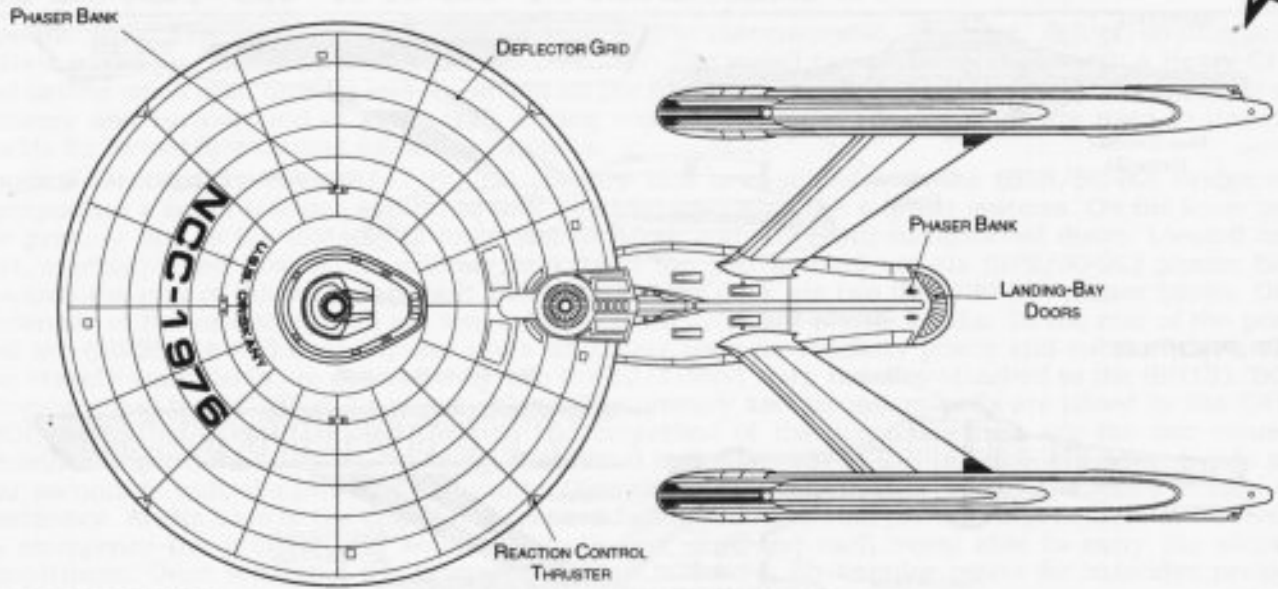

TOP PROFILE

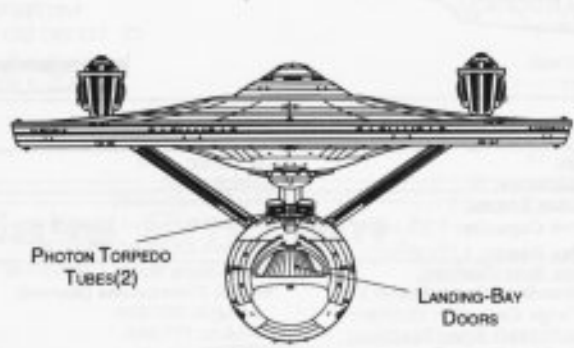

FRONT PROFILE

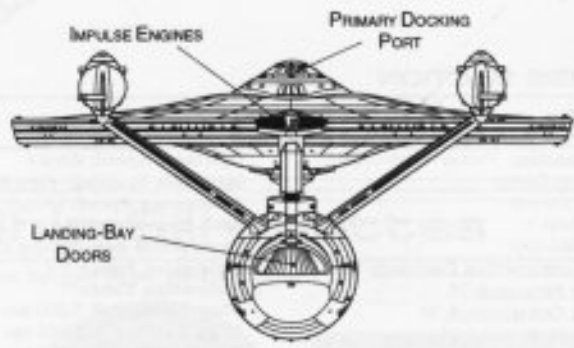

REAR PROFILE

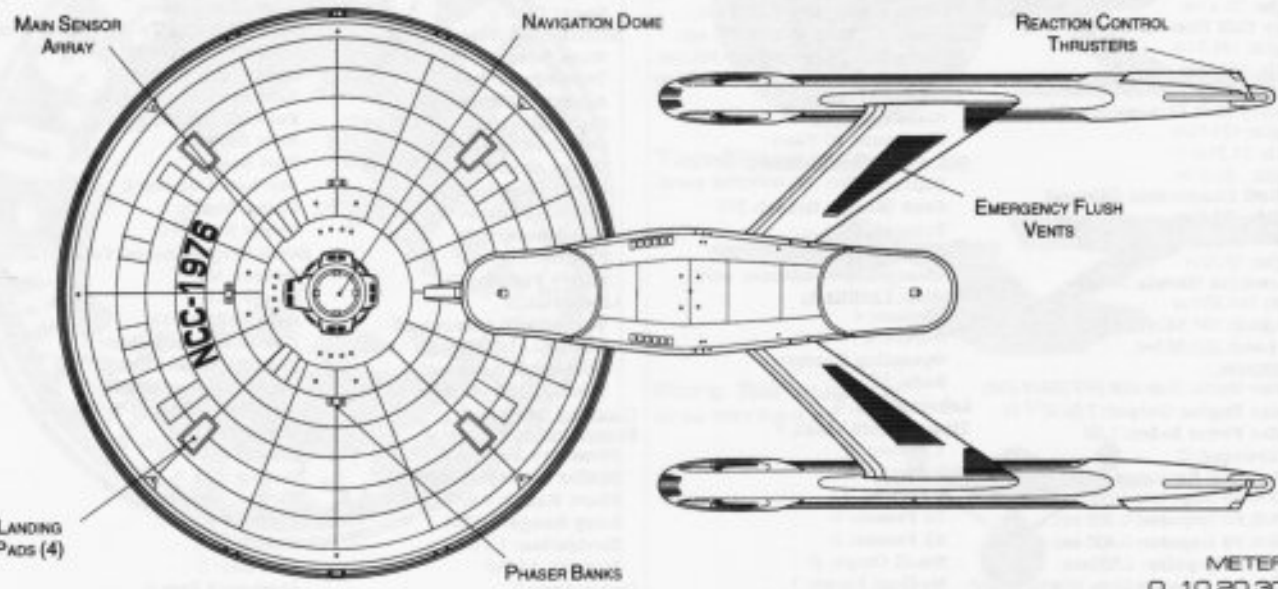

BOTTOM PROFILE



FEDERATION VESSEL



THROUGH DECK CRUISER

Ship Names

THE FOLLOWING SHIPS OF THE MK-XXII CLASS WERE AUTHORIZED BY THE AMENDED ARTICLES OF FEDERATION OF STARDATE 2268.11

BENNINGTON *NCC-1978	RUSSELL *NCC-1974
CARLAT *NCC-1971	SCETO *NCC-1955
CHELSEA *NCC-1969	SMARTT *NCC-1957
CLEMENCEAU *NCC-1977	SOLTER *NCC-1973
CORONADO *NCC-1975	TARINA *NCC-1983
DAUPHINAIS *NCC-1952	UELLEL *NCC-1984
DEVONSHIRE *NCC-1979	WINDSOR *NCC-1956
DRAGO *NCC-1970	YOUNG *NCC-1965
EBREW *NCC-1981	YOURICH *NCC-1959
ESCRIBA *NCC-1960	ZABELL *NCC-1958
FORBUS *NCC-1962**	
KATARINA *NCC-1953	
KIEV *NCC-1960	
KINCAID *NCC-1964	
KINNEBREW *NCC-1951	
KRILE *NCC-1972	
LABRYNTH *NCC-1968	
LAWTON *NCC-1951	
LECHNER *NCC-1963	
MUELLER *NCC-1954	
ORISKANY *NCC-1976*	
PHINAIS *NCC-1962	
PRUITT *NCC-1950	
QUINTEN *NCC-1957	
RITHMIRE *NCC-1966	

*CLASS SHIP, **LOST IN THE LINE OF DUTY, ***PROPOSED, ALL NAMES PRECEDED WITH "U.S.S."

Tractor Beam Specifications

Primary Tractor Beam Load Calculator

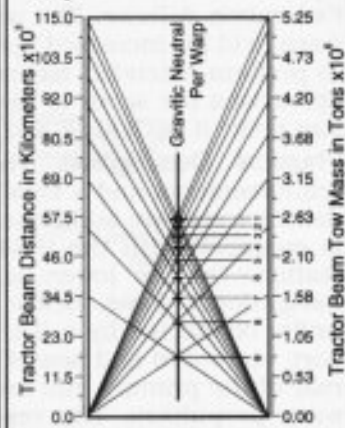

ORISKANY CLASS

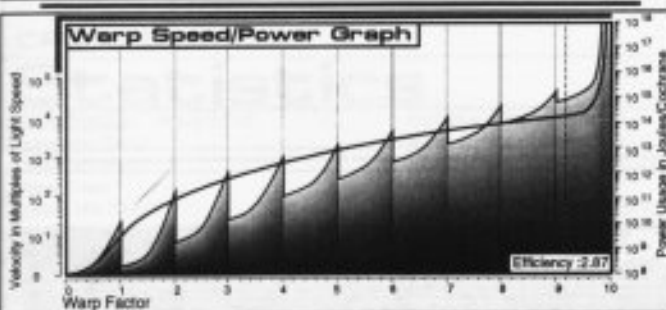
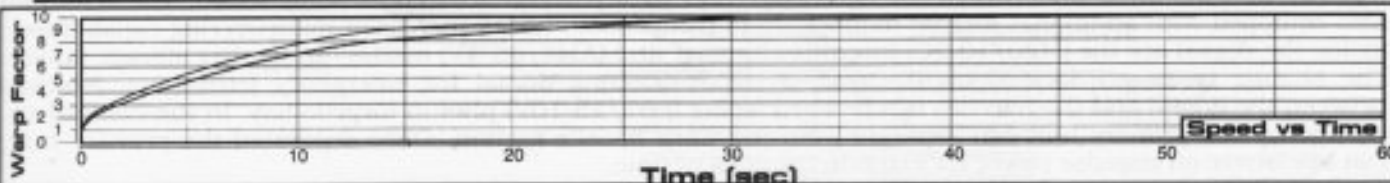

Field Length 828.7m
Field Width 230.8m
Field Height 112.8m

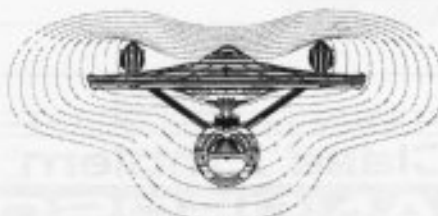

Front Warp Field Profile
Cross Section Area 18142.00 m²

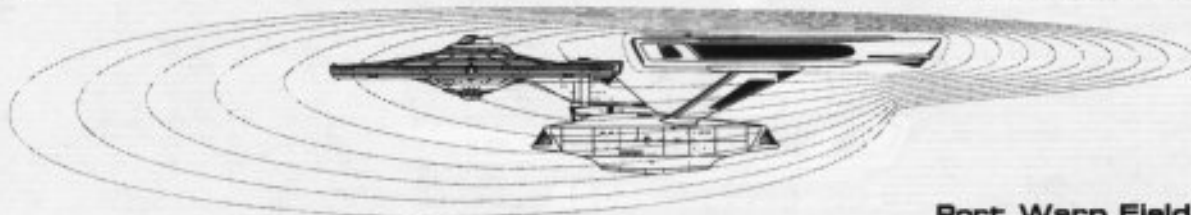

Port Warp Field Profile
Cross Section Area 48594.08 m²

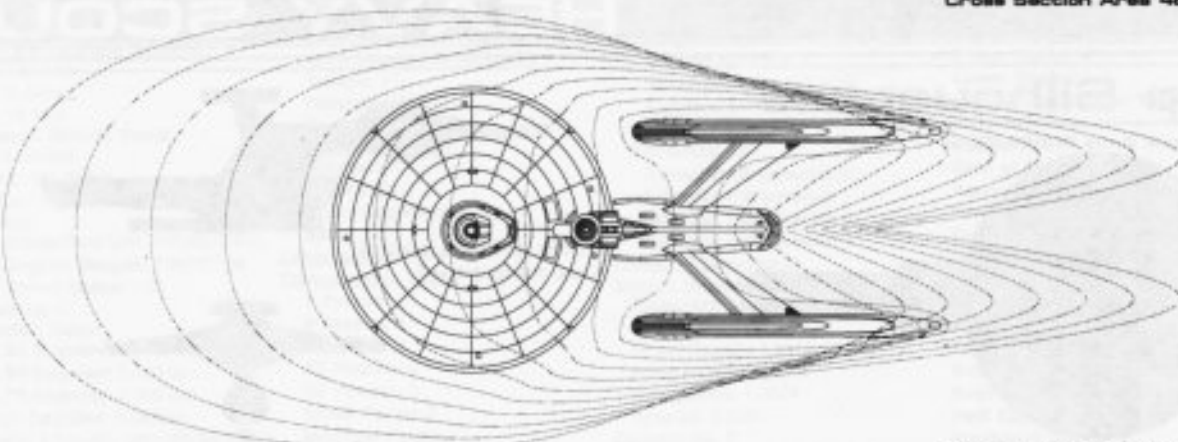

Top Warp Field Profile
Cross Section Area 100920.00 m²

FEDERATION VESSEL

WARP FIELDS

HEAVY SCOUT



ANDERSON CLASS

General Information

Specific Role: The Heavy Scout is an ultra fast, cost effective starship used for patrols, surveillance and Federation defense. The warp nacelles are located side by side which gives the heavy scout a long slender warp field for increased speed. The primary mission of the Scout, using extensive surveillance equipment, is to perform extended reconnaissance patrols into critical areas ahead of Federation vessels. During normal operations the scout is used for both surveillance and picket duty around capital ships. The vessel's small size make it both swift and difficult to target.

Physical Description: The (PH147/S-M3) primary hull is equipped with additional sensors, hull reinforcements and a small hangar deck (located on the upper starboard side). Integrated into the standard deflector grid are additional electronic counter-measures to make the vessel more stealthy. The primary hull is equipped with the (BS11/S-D2) bridge which incorporates the larger enhanced sensors and tracking station. On the lower part of the primary hull is the (SM49/7X) main sensor array and (DN1/5-A) navigational dome. Below the warp nacelles is the (SME978/2A) lower sensor array. Above the impulse units, connected by a (DU/20-5Y) support pylon, is the (SME856/1T) upper sensor array. Located on the port, starboard and bow of the primary hull (both top and bottom) are six (BP2/30-2C) phaser banks. To the rear of the primary hull are (IP186E/4-EG) dual impulse units which are used for auxiliary power and sub-warp propulsion. The vessel's warp fields are generated by two (SW52/1-4FB) warp nacelles siamesed together and mounted underneath the secondary hull by a (DU/60-50F) connecting dorsal. The vessel is also equipped with additional inertial dampeners to compensate for its increased maneuvering capabilities. Inside the dorsal are the (M20/10-2C) intermix chamber and (AM8/36-4V) matter/antimatter storage tanks. The storage tanks are located on the rear of the connecting dorsal for emergency jettisoning. Nestled between the dorsal and the nacelles is a forward facing (PB2/25-10V) photon torpedo bay. In the event of an emergency the primary hull can separate from the warp nacelle section. Once separated the primary hull can maneuver on impulse power for extended periods of time.

Class Emblem

ANDERSON CLASS



HEAVY SCOUT

FEDERATION VESSEL

Ship Silhouettes

Total Target Area 30989.58 m²



Top Silhouette
Area 20870.00 m²



Port Silhouette
Area 7245.64 m²



Front Silhouette
Area 2853.92 m²



HEAVY SCOUT

ANDERSON CLASS

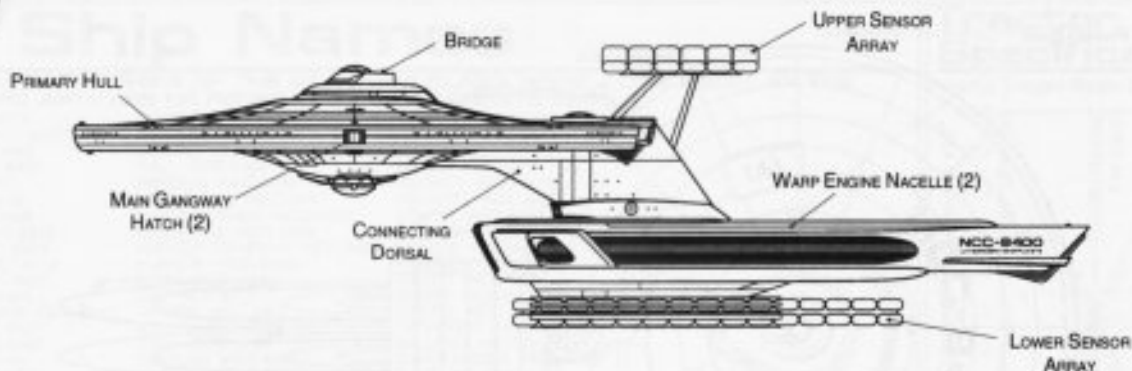

PORT PROFILE

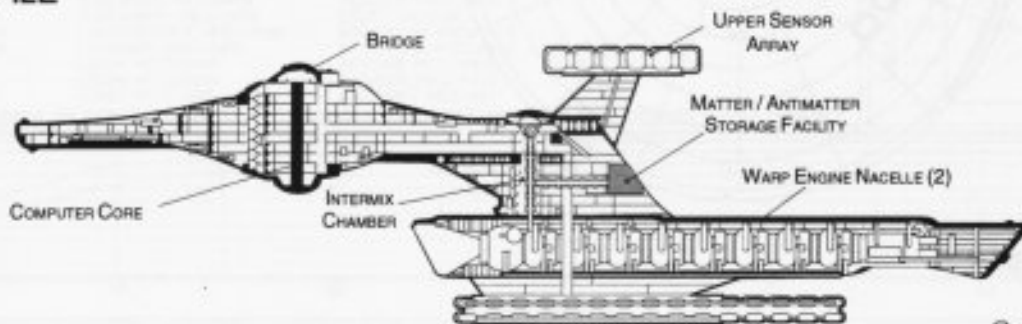

METERS
0 10 20 30 40 50
SCALE 1:2000

CROSS SECTION

Statistics

<p>Classification: Heavy Scout Category: Scout Class: Anderson Type: Class 1 Model: MK-XXXVI Naval Construction Contract: 8400 Number Proposed: 75 Number Constructed: 75 Number in Service: 75 Number Lost: 0 Dimensions: Overall Dimensions (Meters) Length: 255.65m Width: 141.72m Height: 70.42m Primary Hull Dimensions (Meters) Length: 146.31m Width: 141.72m Height: 32.94m Secondary Hull Dimensions (Meters) Length: N/A Width: N/A Height: N/A Warp Unit Dimensions (Meters) Length: 154.81m Width: 12.63m Height: 18.32m Displacement (Metric Tons) Light: 141,265mt Standard: 151,350mt Full Load: 168,955mt Performance: Impulse Units: Dual Unit (IRF35E/3-EG) Impulse Engine Output: 7.8x10¹³ W Impulse Power Index: 1.31 Max Cruising: C Acceleration Rate: 0.00-0.25 Impulse: 0.153 sec. 0.25-0.50 Impulse: 0.230 sec. 0.50-0.75 Impulse: 0.306 sec. 0.75-Full Impulse: 0.383sec. Warp Units: 2 Nacelle Units (SWS2/1-5FB) Warp Engine Output: 1.20x10¹⁵ W Warp Power Index: 1.31</p>	<p>Optimum Speed: Warp 6 Max. Safe Cruising: Warp 8 Emergency Speed: Warp 8.8 Max. Speed: Warp 9.3 Destructive Speed: Warp 9.5 Acceleration Power: 3.0 Acceleration Times: Warp 1 - Warp 2: 0.153 sec. Warp 2 - Warp 3: 0.245 sec. Warp 3 - Warp 4: 0.927 sec. Warp 4 - Warp 5: 1.333 sec. Warp 5 - Warp 6: 1.425 sec. Warp 6 - Warp 7: 1.540 sec. Warp 7 - Warp 8: 1.977 sec. Warp 8 - Warp 9: 2.827 sec. Warp 9 - Warp 9.5: 6.283 sec. Warp 9.5 - Warp 9.75: 7.279 sec. Warp 9.75 - Warp 9.9: 15.093 sec. Duration (Years) Standard: 6 Years Maximum: 24 Years Std. Ships Complement: 370 Officers: 61 Crew (Ensign Grade): 298 Troops: 11 Passengers: 38 Emergency condition: +505 Medical Facilities: Doctors: 4 Nurses: 21 Operating Rooms: 3 Beds: 21 Laboratories: 25 Transporters Total: 9 1 Person: 0 2 Person: 0 6 Person: 3 12 Person: 0 22 Person: 3 Small Cargo: 2 Medium Cargo: 1 Large Cargo: 0 Super Cargo: 0</p>	<p>Brigs: 9 Replicators: 16 Tractor Beams: 1 Tow Capacity: 4.57x10⁶mt Max Range: 1.03x10⁵km Cargo Specification: Standard Cargo Units: 292 Cargo Capacity: 14,600mt Shuttlecraft Specifications: Docking Ports: 3 Shuttlecraft Bays Total: 1 Small Bay: 1 Medium Bay: 0 Large Bay: 0 Super Bay: 0 Shuttlecraft Standard: 15 Work Bees: 1 Travel Pods: 1 Aquatic Shuttle: 0 Light Shuttle: 1 Standard Shuttle: 3 Heavy Shuttle: 1 Cargo Shuttle: 1 Assault Shuttle: 1 Killer Bees: 2 Fighter: 2 Heavy Fighter: 2 Lifeboats: 38 Turbolift (8 person): 23 Lifeboat (10 person): 11 Lifeboat (20 person): 3 Lifeboat (30 person): 1 Cloaking Devices: 0 Sensor Index Values: Planetary Survey: 2.2443 Stellar Survey: 2.2750 Short Range: 1.5412 Long Range: 1.5623 Navigation: 1.0874 Special: 2.5986 Computers: 2 Type: Daystrom Duotronic IIIa Type: Daystrom Duotronic IIw</p>	<p>ECM Index: 1.39 Shield Rating: Shield Index: 1.40 Holdoff Power: 3.47x10¹² W Refresh Rate: 9.85x10¹¹ W Breakdown Rate: 1.18x10¹² W Shield Dimensions (Meters) Length: 322.93m Width: 177.01m Height: 88.96m Weapons: Phaser Power Index: 0.87 Photon Power Index: 2.09 Vessel Power Index: 1.48 Weapon Placement: Beam (Phasers) Total: 6 banks 2 each Output: 5.0x10¹¹ W / 2.5x10¹¹ W Range: 2.5x 10⁵ km Rate of Fire: 30 ppm / Cont. Forward Banks: 2 Rear Banks: 0 Port Banks: 2 Starboard Banks: 2 Upper Banks: 0 Lower Banks: 0 Beam (MegaPhasers) Total: 0 Output: N/A Range: N/A Rate of Fire: N/A Forward/Rear Banks: 0 Port/Starboard Banks: 0 Upper/Lower Banks: 0 Torpedoes (Photon) Total: 1 Bay 2 each Stock: 40 Range: 2.0x 10⁵ km Output: 10-50 Megatons Rate of Fire: 10 spm Forward Bay: 1 Rear Bay: 0 Port Bay: 0 Starboard Bay: 0 Upper Bay: 0 Lower Bay: 0</p>
---	--	---	--

FEDERATION VESSEL

HEAVY SCOUT



ANDERSON CLASS

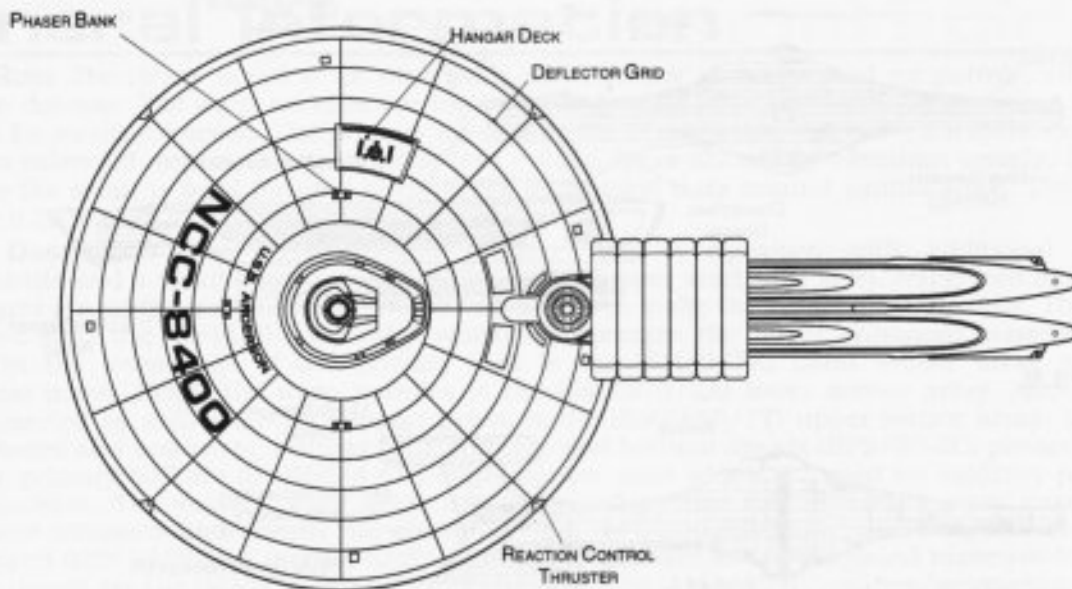

TOP PROFILE

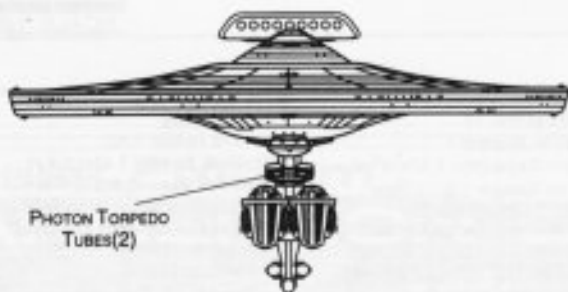

FRONT PROFILE

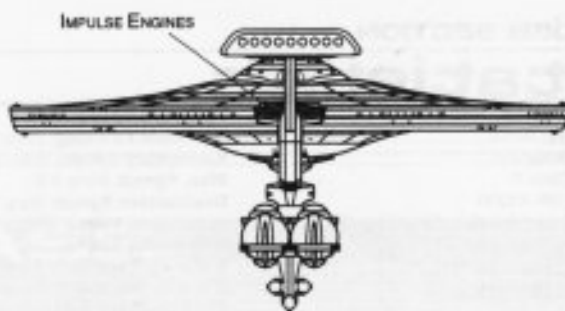

REAR PROFILE

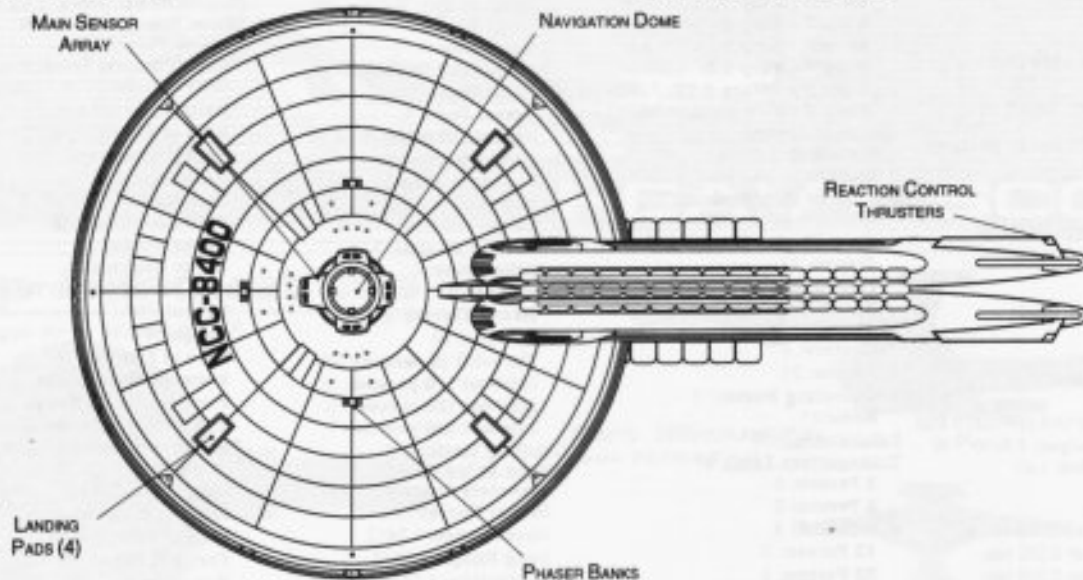

BOTTOM PROFILE

METERS
0 10 20 30 40 50
SCALE 1:2000

FEDERATION VESSEL



HEAVY SCOUT

Ship Names

THE FOLLOWING SHIPS OF THE MK-XXXVI CLASS WERE AUTHORIZED BY THE AMENDED ARTICLES OF FEDERATION OF STARDATE 2269.4

ABNEY *NCC-8474	GIDEON *NCC-8438	MAHAFFEY *NCC-8446
ANDERSON *NCC-8400*	GISONNO *NCC-8425	MASKEW *NCC-8443
ANGLIN *NCC-8455	GOMMORHEA *NCC-8431	MAXEY *NCC-8401
ANURAS *NCC-8452	HALL *NCC-8420	MILLER *NCC-8410
ARCE *NCC-8403	HAMBLIN *NCC-8430	NEIGHLY *NCC-8439
BEALL *NCC-8438	HARRELSON *NCC-8441	NEVAREZ *NCC-8435
BOGUE *NCC-8428	HIGGINBOTHAM *NCC-8450	OCHOA *NCC-8429
BRANDON *NCC-8419	HOLLERON *NCC-8456	OVERMAN *NCC-8437
CARRIOW *NCC-8406	HUDSON COMPANY *NCC-8461	PEARCE *NCC-8404
CHAUFANT *NCC-8414	HUNKER *NCC-8466	PEEPLER *NCC-8433
CLAUSEN *NCC-8423	IDOM *NCC-8468	PIEPER *NCC-8427
DABOV *NCC-8434	IGO *NCC-8473	RAMBY *NCC-8432
DENNISON-FLARE *NCC-8442	JAYROE *NCC-8471	RIVERS *NCC-8424
DOWELL *NCC-8447	JOPLIN *NCC-8469	RUTHARDT *NCC-8417
EBELING *NCC-8462	JUDD *NCC-8464	SALDINA *NCC-8426
EMBYR *NCC-8457	KECKLER *NCC-8460	SCHOENROCK *NCC-8422
ESTORGA *NCC-8470	KIMBLE *NCC-8463	STERLING *NCC-8418
FABELA *NCC-8472	KRAUSS *NCC-8458	TENNISON *NCC-8421
FALLON *NCC-8402	KRAUSS *NCC-8458	TILLMON *NCC-8416
FODOR *NCC-8467	KRISTINEK *NCC-8409	UTLEY *NCC-8415
FULBRIGHT *NCC-8459	KUHLMANN *NCC-8453	WALRAVEN *NCC-8408
FURGESON *NCC-8454	LABOURDETTE *NCC-8455	WILLIFORD *NCC-8412
GAASCH *NCC-8449	LEHAMAN *NCC-8451	WOLSKIE *NCC-8405
GAMBLE *NCC-8445	LEIGH *NCC-8407	YOAKUM *NCC-8413
GERMANY *NCC-8440	LICON *NCC-8448	ZALDIVAR *NCC-8411
	LOKEL *NCC-8444	

*CLASS SHIP. **LOST IN THE LINE OF DUTY. ***PROPOSED. ALL NAMES PRECEDED WITH "U.S.S."

Tractor Beam Specifications

Primary Tractor Beam Load Calculator

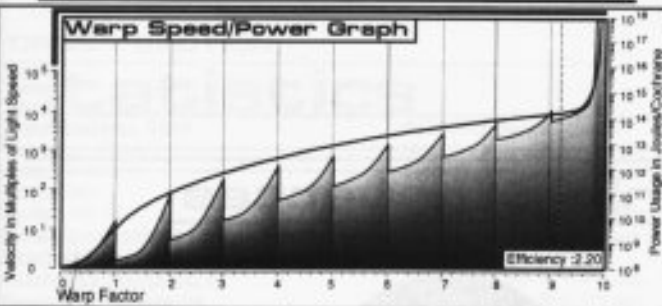
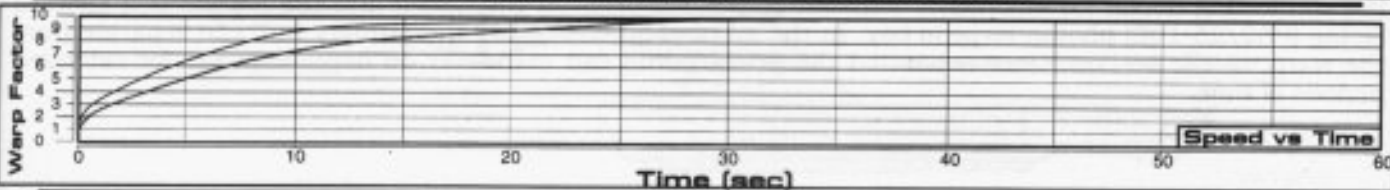
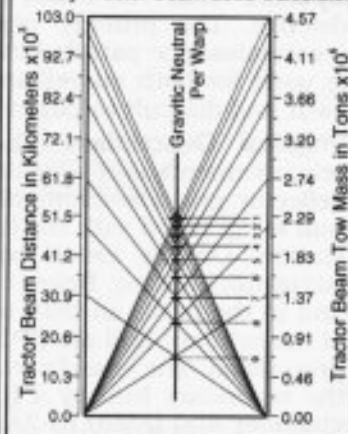

Field Length 824.50m
Field Width 175.70m
Field Height 84.70m



Front Warp Field Profile
Cross Section Area 11848.04 m²



Port Warp Field Profile
Cross Section Area 34895.88 m²

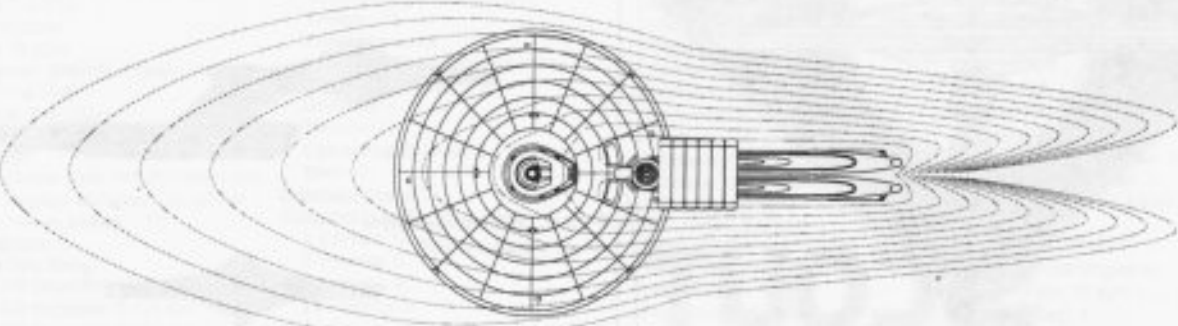

Top Warp Field Profile
Cross Section Area 73317.52 m²

WARP FIELDS

SRM2 04:04:01:04

STARFLEET REFERENCE MANUAL

ANDERSON CLASS

FEDERATION VESSEL

SCOUT



ANUBIS CLASS

General Information

Specific Role: The Scout is an fast, cost effective starship used for patrols, surveillance and Federation defense. The primary mission of the Scout, using surveillance equipment, is to perform extended reconnaissance patrols into critical areas ahead of Federation vessels. During normal operations the scout is used for both surveillance and picket duty around capital ships. The vessel's small size make it both swift and difficult to target.

Physical Description: The (PH147/S-M2) primary hull is equipped with additional sensors, hull reinforcements and a small hangar deck (located on the upper starboard side). Integrated into the standard deflector grid are additional electronic counter-measures to make the vessel more stealthy. The primary hull is equipped with the (BS11/S-D1) bridge which incorporates the larger enhanced sensors and tracking station. On the lower part of the primary hull is the (SM49/4H) main sensor array and (DN1/9-1) navigational dome. Below the warp nacelles is the (SME352/2A) lower sensor array. Located port, starboard and to the front, on both top and bottom of the primary hull are 6 (BP2/30-2C) phaser banks. To the rear of the primary hull are (IP186E/2-SB) dual impulse units which are used for auxiliary power and sub-warp propulsion. The vessel's warp fields are generated a single (SW52/1-5HI) warp nacelle mounted underneath the secondary hull by a (DU/50-48S) connecting dorsal. Inside the dorsal are the (M20/10-1E) intermix chamber and (AM8/18-2A) matter/antimatter storage tanks. The storage tanks are located on the rear of the connecting dorsal for emergency jettisoning. Nestled between the dorsal and the nacelle is a forward facing (PB2/25-10E) photon torpedo bay. In the event of an emergency the primary hull can separate from the warp nacelle section. Once separated the primary hull can maneuver on impulse power for extended periods of time.

Class Emblem

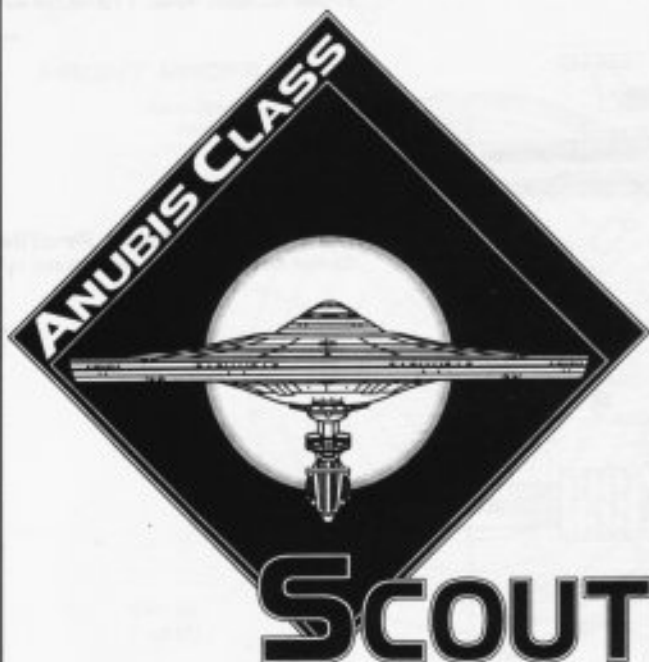

Ship Silhouettes

Total Target Area 27021.37 m²

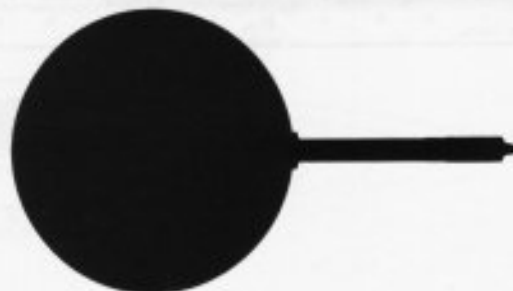

Top Silhouette
Area 18870.17 m²



Port Silhouette
Area 5806.24 m²



Front Silhouette
Area 2344.96 m²

FEDERATION VESSEL

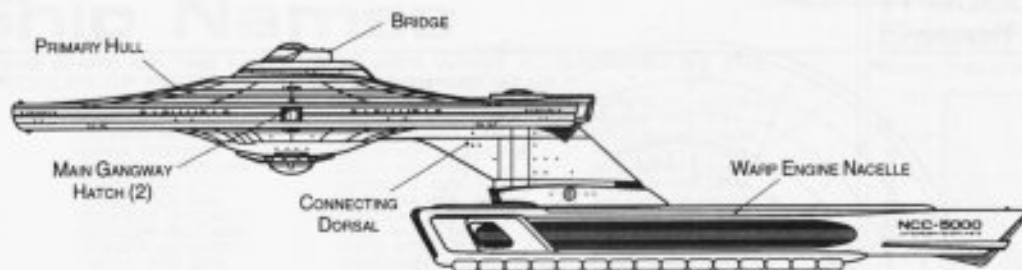

PORT PROFILE

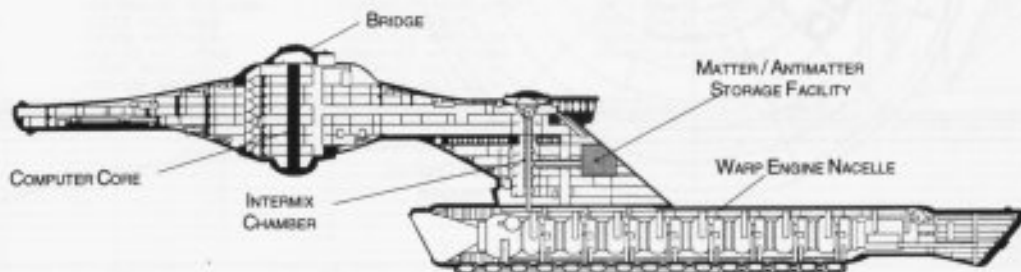

CROSS SECTION

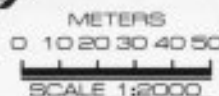

Statistics

Classification: Scout
Category: Scout
Class: Anderson
Type: Class 1
Model: MK-VII
Naval Construction Contract: 5000
Number Proposed: 98
Number Constructed: 98
Number in Service: 94
Number Lost: 4
Dimensions:
Overall Dimensions (Meters)
 Length: 255.65m
 Width: 141.72m
 Height: 58.17m
Primary Hull Dimensions (Meters)
 Length: 146.31m
 Width: 141.72m
 Height: 32.94m
Secondary Hull Dimensions (Meters)
 Length: N/A
 Width: N/A
 Height: N/A
Warp Unit Dimensions (Meters)
 Length: 154.81m
 Width: 12.63m
 Height: 18.32m
Displacement (Metric Tons)
 Light: 141,265mt
 Standard: 151,350mt
 Full Load: 168,955mt
Performance:
Impulse Units: Dual Unit (JRF35E/3-SB)
Impulse Engine Output: 7.8×10^{13} W
Impulse Power Index: 1.70
Max Cruising: C
Acceleration Rate:
 0.00-0.25 Impulse: 0.117 sec.
 0.25-0.50 Impulse: 0.176 sec.
 0.50-0.75 Impulse: 0.235 sec.
 0.75-Full Impulse: 0.294 sec.
Warp Units: 2 Nacelle Units (SW52/1-5HI)
Warp Engine Output: 1.20×10^{15} W
Warp Power Index: 0.85

Optimum Speed: Warp 4
Max. Safe Cruising: Warp 6
Emergency Speed: Warp 8.01
Max. Speed: Warp 9.11
Destructive Speed: Warp 9.26
Acceleration Power: 3.0
Acceleration Times:
 Warp 1 - Warp 2: 0.235 sec.
 Warp 2 - Warp 3: 0.376 sec.
 Warp 3 - Warp 4: 1.422 sec.
 Warp 4 - Warp 5: 2.044 sec.
 Warp 5 - Warp 6: 2.185 sec.
 Warp 6 - Warp 7: 2.361 sec.
 Warp 7 - Warp 8: 3.031 sec.
 Warp 8 - Warp 9: 4.335 sec.
 Warp 9 - Warp 9.5: 9.634 sec.
 Warp 9.5 - Warp 9.75: 11.161 sec.
 Warp 9.75 - Warp 9.9: 23.144 sec.
Duration (Years)
 Standard: 6 Years
 Maximum: 24 Years
Std. Ships Complement: 344
 Officers: 57
 Crew (Ensign Grade): 277
 Troops: 10
 Passengers: 29
 Emergency condition: +461
Medical Facilities:
 Doctors: 4
 Nurses: 21
 Operating Rooms: 3
 Beds: 21
Laboratories: 20
Transporters Total: 9
 1 Person: 0
 2 Person: 0
 6 Person: 3
 12 Person: 0
 22 Person: 3
 Small Cargo: 2
 Medium Cargo: 1
 Large Cargo: 0
 Super Cargo: 0

Brigs: 7
Replicators: 11
Tractor Beams: 1
 Tow Capacity: 2.61×10^6 mt
 Max Range: 7.43×10^4 km
Cargo Specification:
 Standard Cargo Units: 191
 Cargo Capacity: 9,500mt
Shuttlecraft Specifications:
 Docking Ports: 3
 Shuttlecraft Bays Total: 1
 Small Bay: 1
 Medium Bay: 0
 Large Bay: 0
 Super Bay: 0
 Shuttlecraft Standard: 15
 Work Bees: 1
 Travel Pods: 1
 Aquatic Shuttle: 0
 Light Shuttle: 1
 Standard Shuttle: 3
 Heavy Shuttle: 1
 Cargo Shuttle: 1
 Assault Shuttle: 1
 Killer Bees: 2
 Fighter: 2
 Heavy Fighter: 2
 Lifeboats: 38
 Turbolift (8 person): 23
 Lifeboat (10 person): 11
 Lifeboat (20 person): 3
 Lifeboat (30 person): 1
Cloaking Devices: 0
Sensor Index Values:
 Planetary Survey: 1.7144
 Stellar Survey: 1.7570
 Short Range: 1.2935
 Long Range: 1.3526
 Navigation: 0.9987
 Special: 1.8196
Computers: 2
 Type: Daystrom Duotronic III's
 Type: Daystrom Duotronic II's

ECM Index: 1.37
Shield Rating:
 Shield Index: 1.60
 Holdoff Power: 3.04×10^{12} W
 Refresh Rate: 8.64×10^{11} W
 Breakdown Rate: 1.04×10^{12} W
Shield Dimensions (Meters)
 Length: 322.93m
 Width: 177.01m
 Height: 73.48m
Weapons:
Phaser Power Index: 1.135
Photon Power Index: 2.04
Vessel Power Index: 1.59
Weapon Placement:
Beam (Phasers) Total: 6 banks 2 each
 Output: 5.0×10^{11} W / 2.5×10^{11} W
 Range: 2.5×10^5 km
 Rate of Fire: 30 ppm / Cont.
 Forward Banks: 2
 Rear Banks: 0
 Port Banks: 2
 Starboard Banks: 2
 Upper Banks: 0
 Lower Banks: 0
Beam (MegaPhasers) Total: 0
 Output: N/A
 Range: N/A
 Rate of Fire: N/A
 Forward/Rear Banks: 0
 Port/Starboard Banks: 0
 Upper/Lower Banks: 0
Torpedoes (Photon) Total: 1 Bay 2 each
 Stock: 30
 Range: 2.0×10^5 km
 Output: 10-50 Megatons
 Rate of Fire: 10 spm
 Forward Bay: 1
 Rear Bay: 0
 Port Bay: 0
 Starboard Bay: 0
 Upper Bay: 0
 Lower Bay: 0

SCOUT



ANUBUS CLASS

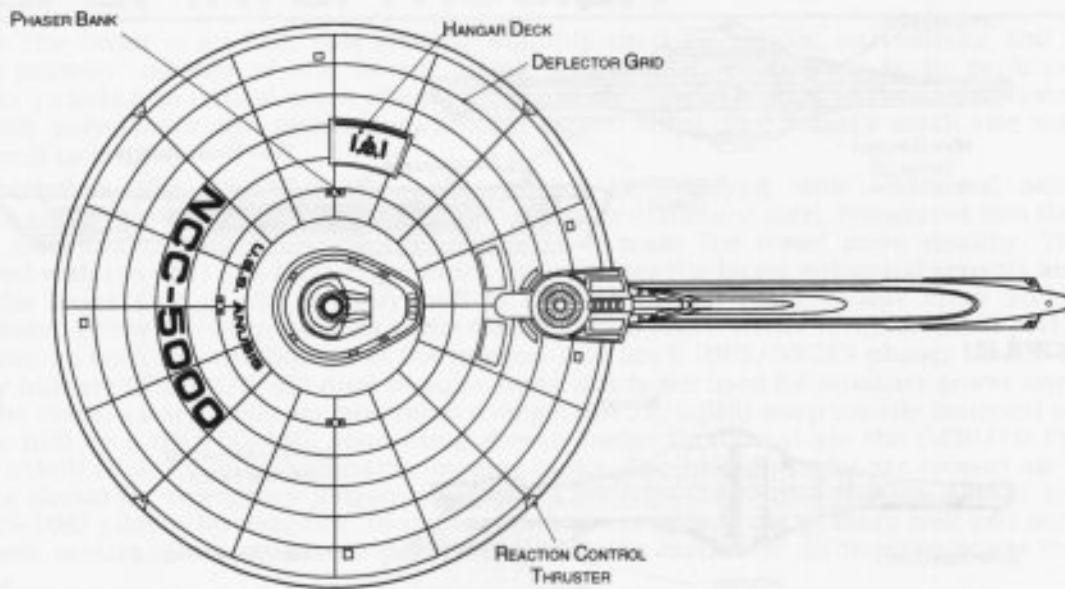

TOP PROFILE

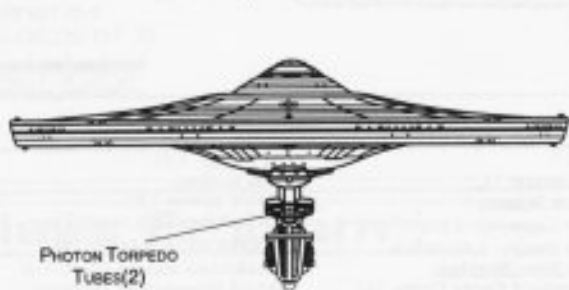

FRONT PROFILE

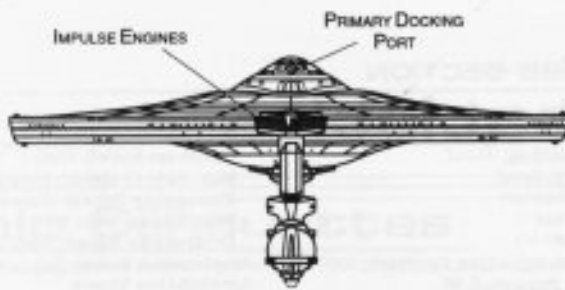

REAR PROFILE

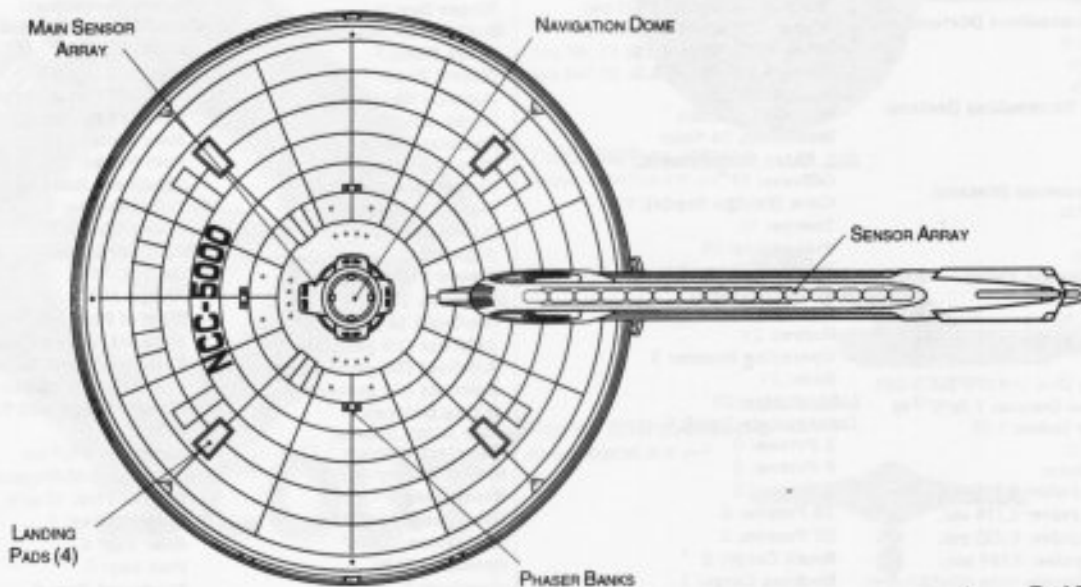

BOTTOM PROFILE

METERS
0 10 20 30 40 50
SCALE 1:2000

FEDERATION VESSEL



Ship Names

THE FOLLOWING SHIPS OF THE MK-XXX CLASS WERE AUTHORIZED BY THE AMENDED ARTICLES OF FEDERATION OF STARDATE 2269.3

AEOLUS *NCC-5002**	CYGNUS *NCC-5031	KILPATRICK *NCC-5065	QUINTILLUS *NCC-5004
ANUBUS *NCC-5000*	DABILLA *NCC-5069	LAGRONE *NCC-5081	RAMOS *NCC-5074
APPEL *NCC-5063	DEBNAM *NCC-5063	LEO *NCC-5021	REDWINE *NCC-5045
ARFUS *NCC-5032	DIANA *NCC-5003	LEO MINOR *NCC-5028	REVERE *NCC-5009
AQUILA *NCC-5037	DOWNING *NCC-5068	LEPUS *NCC-5024	RIEGER *NCC-5040
ARIES *NCC-5016	DYKES *NCC-5051	LEVERETT *NCC-5084	ROLLINS *NCC-5090
AVERRITT *NCC-5060	ECKEL *NCC-5042	LOHMANN *NCC-5088**	SACAJAWEA *NCC-5012
BAGGETT *NCC-5066	EQUULUS *NCC-5017	LUPUS *NCC-5018	SARTAIN *NCC-5068
BATIDOR *NCC-5007	ESCALON *NCC-5049	LYNX *NCC-5022	SELBY *NCC-5067**
BORSCH *NCC-5073	EVERITT *NCC-5071	MARR *NCC-5086	SNEED *NCC-5047
BOWIE *NCC-5011	FABILA *NCC-5078	MASERANG *NCC-5082	SPAKER *NCC-5010
BRIDGER *NCC-5065	FIEST *NCC-5083	MAXHEIMER *NCC-5075	TAULBEE *NCC-5061
BURTON *NCC-5080	FORBES *NCC-5089	MEURER *NCC-5077	TAURUS *NCC-5019
CAMELOPARDUS *NCC-5020	GILLMORE *NCC-5096	MONOCEROS *NCC-5015	THATCHER *NCC-5043
CANIS MAJOR *NCC-5025	GRADEL *NCC-5093	NAUSELY *NCC-5079	TIMMS *NCC-5062
CANIS MINOR *NCC-5029	GRUS *NCC-5038	NORTHCUTT *NCC-5064	TONTI *NCC-5013
CARSON *NCC-5066	HAIGHT *NCC-5067	ODELL *NCC-5041	TRICE *NCC-5057
CARSTEN *NCC-5065	HAMILTON *NCC-5092	OLIVAS *NCC-5044	TUCANA *NCC-5033
CLAUENCH *NCC-5091	HERMES *NCC-5001	PACE *NCC-5048	UPSHAW *NCC-5056
CODY *NCC-5008	HUSEMANN *NCC-5094	PARMELEY *NCC-5054**	URSA MAJOR *NCC-5023
COLUMBIA *NCC-5035	ICKES *NCC-5096	PAVO *NCC-5036	URSA MINOR *NCC-5030
CONRAD *NCC-5097	ISHAM *NCC-5090	PEGASUS *NCC-5026	VANN *NCC-5072
CORVUS *NCC-5034	JAEKEL *NCC-5048	PENNYER *NCC-5059	VULPECULA *NCC-5027
CROCKETT *NCC-5014	JURIK *NCC-5055	PHOENIX *NCC-5039	
CURRY *NCC-5076	KEEFER *NCC-5062	QUIJADA *NCC-5070	

*CLASS SHIP, **LOST IN THE LINE OF DUTY, ***PROPOSED, ALL NAMES PRECEDED WITH "U.S.S."

Tractor Beam Specifications

Primary Tractor Beam Load Calculator

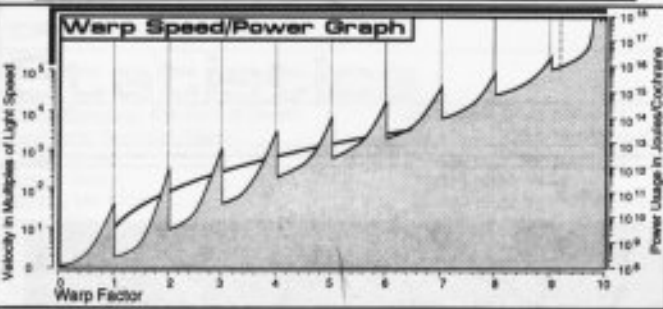
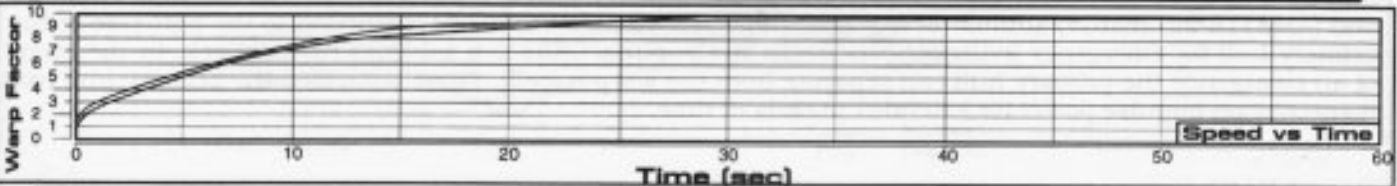
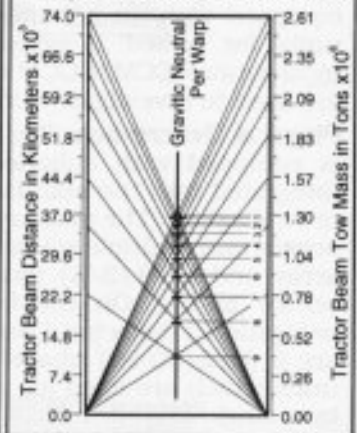

Field Length 548.28m
Field Width 173.44m
Field Height 71.15m



Front Warp Field Profile
Cross Section Area 11500.6 m²

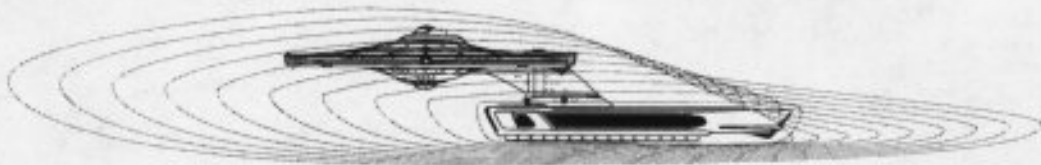

Port Warp Field Profile
Cross Section Area 29343.40 m²

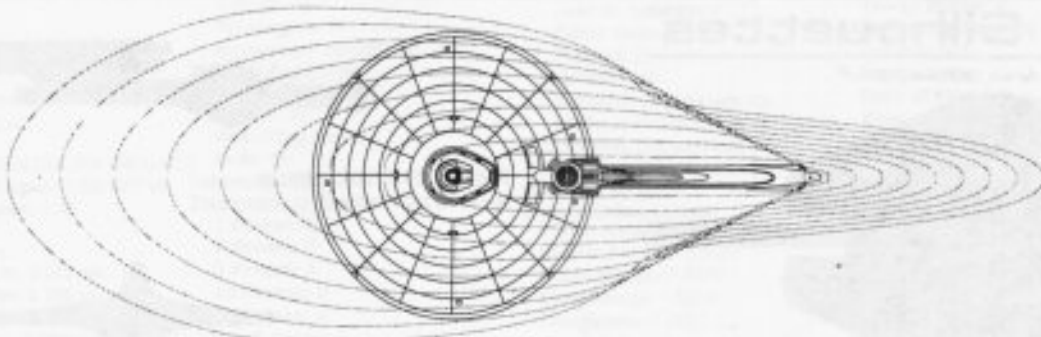

Top Warp Field Profile
Cross Section Area 58359.92 m²

WARP FIELDS

EXPLORATION CRUISER



GREGORY CLASS

General Information

Specific Role: The Exploration Cruiser is an extensive system charting and exploration vessel. The ship is equipped with an enhanced sensor arrays for extensive solar system exploration and two dual impulse units for added in-system maneuverability. In order to maintain the Prime Directive, the cruiser incorporates ECM/ECCM devices to reduce the risk of being detected by developing cultures. These vessels are used to investigate worlds for formal first contact.

Physical Description: The Exploratory Cruiser incorporates an extended (PHE147/F-M1) primary hull and is equipped with enhanced passive sensors, advanced research systems and additional laboratories. Integrated into the standard deflector grid are additional electronic counter-measures to make the vessel more stealthy. The primary hull is equipped with the (BS11/R-E2) bridge which incorporates the enhanced sensor and multiple scientific stations. On the lower part of the primary hull is the (SM49/7N) main sensor array and (DN1/3-W) navigational dome. Underneath the primary hull are three (SME142/2A) passive sensor arrays. On the front of the primary hull is an integrated (SMEN198/8N) sensor array and navigational deflector. Located port, starboard and to the front, on both top and bottom of the primary hull are 6 (BP2/30-2C) phaser banks. To the rear of the primary hull are two (IP186E/2-WD) dual impulse units which are used for auxiliary power and sub-warp propulsion. The vessel's warp fields are generated by a single (SW52/1-5EB) warp nacelle located above the primary hull. The warp nacelle is attached to the hull by a (DU/58-51F) connecting dorsal. Inside the primary hull are the (M20/10-1Q) intermix chamber and (AM8/18-2Z) matter/antimatter storage tanks. The storage tanks are positioned to the port side of the primary hull for emergency jettisoning. Between the impulse units is a medium hangar deck. In the event of an emergency the primary hull can separate from the warp nacelle. Once separated the primary hull can maneuver on impulse power for extended periods of time.

Class Emblem

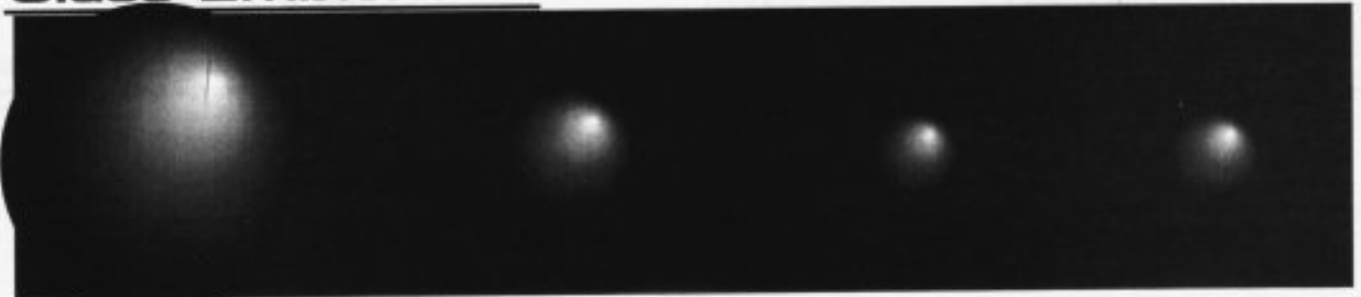

GREGORY CLASS EXPLORATION CRUISER

Ship Silhouettes

Total Target Area 30844.12 m²

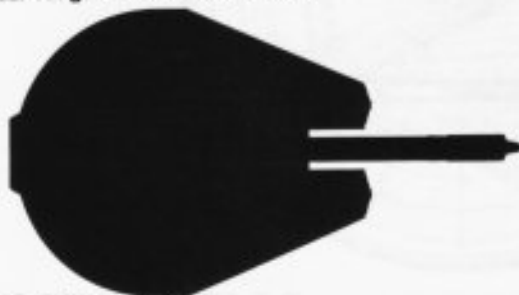

Top Silhouette
Area 22896.00 m²

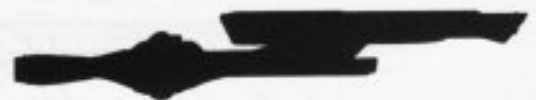

Port Silhouette
Area 5751.92 m²



Front Silhouette
Area 2196.20 m²

FEDERATION VESSEL



EXPLORATION CRUISER

GREGORY CLASS

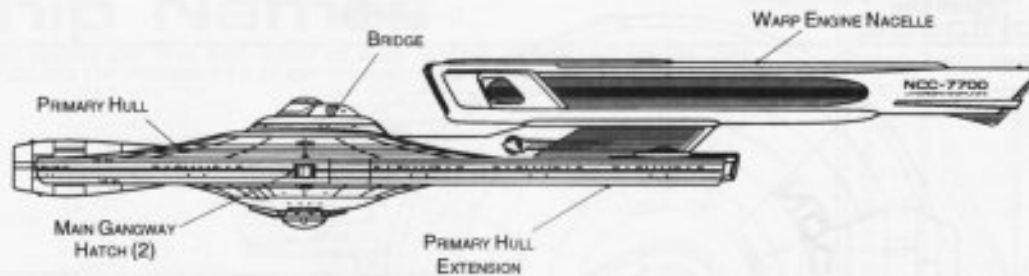

PORT PROFILE

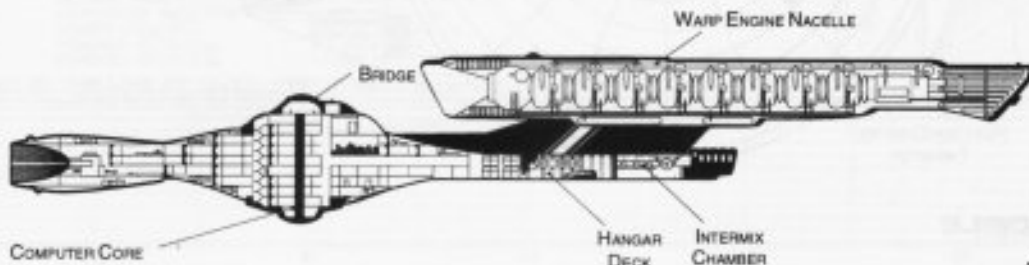

METERS
0 10 20 30 40 50
SCALE 1:2000

CROSS SECTION

Statistics

Classification: Exploration Cruiser

Category: Research Vessel

Class: Gregory

Type: Class 1

Model: MK-XXIV

Naval Construction Contract: 7700

Number Proposed: 83

Number Constructed: 83

Number in Service: 75

Number Lost: 8

Dimensions:

Overall Dimensions (Meters)

Length: 257.93m

Width: 141.72m

Height: 41.91m

Primary Hull Dimensions (Meters)

Length: 182.59m

Width: 141.72m

Height: 32.94m

Secondary Hull Dimensions (Meters)

Length: N/A

Width: N/A

Height: N/A

Warp Unit Dimensions (Meters)

Length: 154.81m

Width: 12.63m

Height: 18.32m

Displacement (Metric Tons)

Light: 132,499mt

Standard: 141,958mt

Full Load: 158,470mt

Performance:

Impulse Units: 2 Dual Unit (IRF35E/S-WD)

Impulse Engine Output: 1.56×10^{14} W

Impulse Power Index: 1.39

Max Cruising: C

Acceleration Rate:

0.00-0.25 Impulse: 0.072 sec.

0.25-0.50 Impulse: 0.106 sec.

0.50-0.75 Impulse: 0.144 sec.

0.75-Full Impulse: 0.180 sec.

Warp Units: 1 Nacelle Units (SW52/1-SEB)

Warp Engine Output: 6.00×10^{14} W

Warp Power Index: 0.70

Optimum Speed: Warp 4

Max. Safe Cruising: Warp 5

Emergency Speed: Warp 7

Max. Speed: Warp 8.2

Destructive Speed: Warp 8.4

Acceleration Power: 3.0

Acceleration Times:

Warp 1 - Warp 2: 0.287 sec.

Warp 2 - Warp 3: 0.460 sec.

Warp 3 - Warp 4: 1.739 sec.

Warp 4 - Warp 5: 2.501 sec.

Warp 5 - Warp 6: 2.673 sec.

Warp 6 - Warp 7: 2.889 sec.

Warp 7 - Warp 8: 3.708 sec.

Warp 8 - Warp 9: 5.303 sec.

Warp 9 - Warp 9.5: 11.785 sec.

Warp 9.5 - Warp 9.75: 13.654 sec.

Warp 9.75 - Warp 9.9: 28.313 sec.

Duration (Years)

Standard: 6 Years

Maximum: 24 Years

Std. Ships Complement: 443

Officers: 73

Crew (Ensign Grade): 357

Troops: 13

Passengers: 36

Emergency condition: +592

Medical Facilities:

Doctors: 3

Nurses: 16

Operating Rooms: 2

Beds: 16

Laboratories: 14

Transporters Total: 10

1 Person: 0

2 Person: 0

6 Person: 4

12 Person: 0

22 Person: 4

Small Cargo: 1

Medium Cargo: 1

Large Cargo: 0

Super Cargo: 0

Brigs: 9

Replicators: 14

Tractor Beams: 1

Tow Capacity: 1.46×10^6 mt

Max Range: 6.68×10^4 km

Cargo Specification:

Standard Cargo Units: 235

Cargo Capacity: 11,750mt

Shuttlecraft Specifications:

Docking Ports: 2

Shuttlecraft Bays Total: 1

Small Bay: 0

Medium Bay: 1

Large Bay: 0

Super Bay: 0

Shuttlecraft Standard: 26

Work Bees: 2

Travel Pods: 2

Aquatic Shuttle: 2

Light Shuttle: 1

Standard Shuttle: 6

Survey Shuttle: 6

Heavy Shuttle: 1

Cargo Shuttle: 1

Assault Shuttle: 1

Killer Bees: 2

Fighter: 2

Lifeboats: 45

Turbolift (8 person): 23

Lifeboat (10 person): 16

Lifeboat (20 person): 6

Lifeboat (30 person): 0

Cloaking Devices: 0

Sensor Index Values:

Planetary Survey: 1.7679

Stellar Survey: 2.0191

Short Range: 1.3339

Long Range: 1.5234

Navigation: 0.6992

Special: 1.1660

Computers: 2

Type: Daystrom Duotronic III:k

Type: Daystrom Duotronic II:n

ECM Index: 1.25

Shield Rating:

Shield Index: 1.19

Holdoff Power: 2.76×10^{12} W

Refresh Rate: 7.86×10^{11} W

Breakdown Rate: 9.43×10^{11} W

Shield Dimensions (Meters)

Length: 325.80m

Width: 177.01m

Height: 52.94m

Weapons:

Phaser Power Index: 1.135

Photon Power Index: 0.00

Vessel Power Index: 0.568

Weapon Placement:

Beam (Phasers) Total: 6 banks 2 each

Output: 5.0×10^{11} W / 2.5×10^{11} W

Range: 2.5×10^5 km

Rate of Fire: 30 ppm / Cont.

Forward Banks: 2

Rear Banks: 0

Port Banks: 2

Starboard Banks: 2

Upper Banks: 0

Lower Banks: 0

Beam (MegaPhasers) Total: 0

Output: N/A

Range: N/A

Rate of Fire: N/A

Forward/Rear Banks: 0

Port/Starboard Banks: 0

Upper/Lower Banks: 0

Torpedoes (Photon) Total: N/A

Stock: N/A

Range: N/A

Output: N/A

Rate of Fire: N/A

Forward Bay: 0

Rear Bay: 0

Port Bay: 0

Starboard Bay: 0

Upper Bay: 0

Lower Bay: 0

FEDERATION VESSEL

EXPLORATION CRUISER



GREGORY CLASS

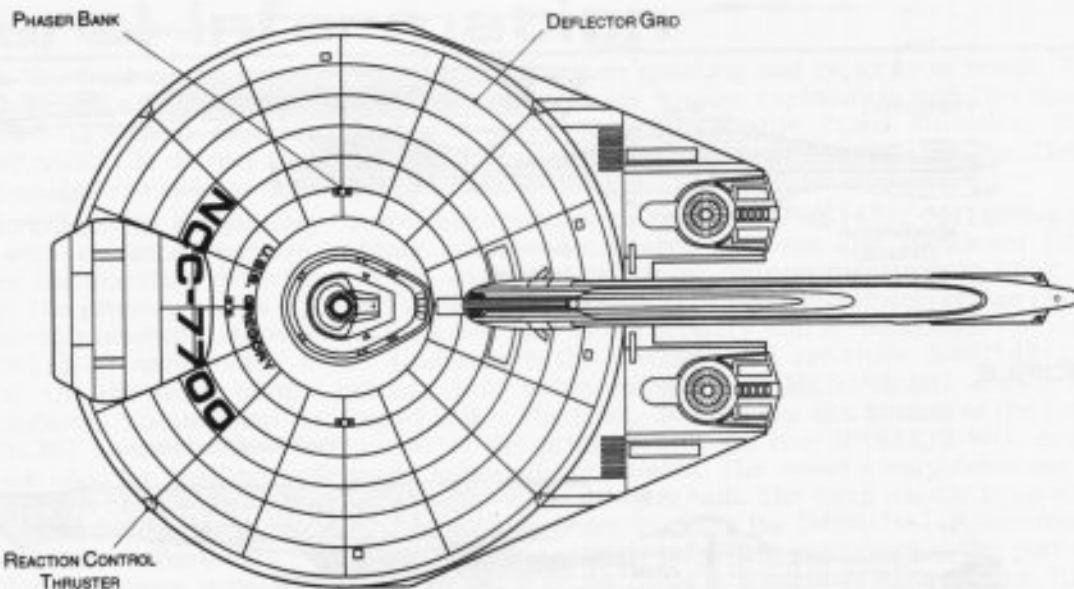

TOP PROFILE



FRONT PROFILE

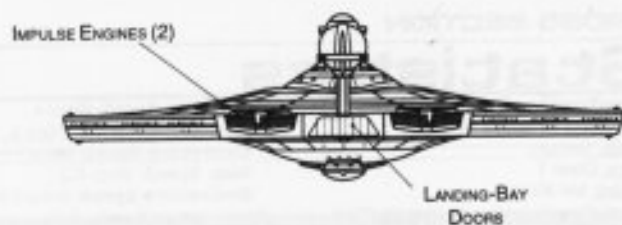

REAR PROFILE

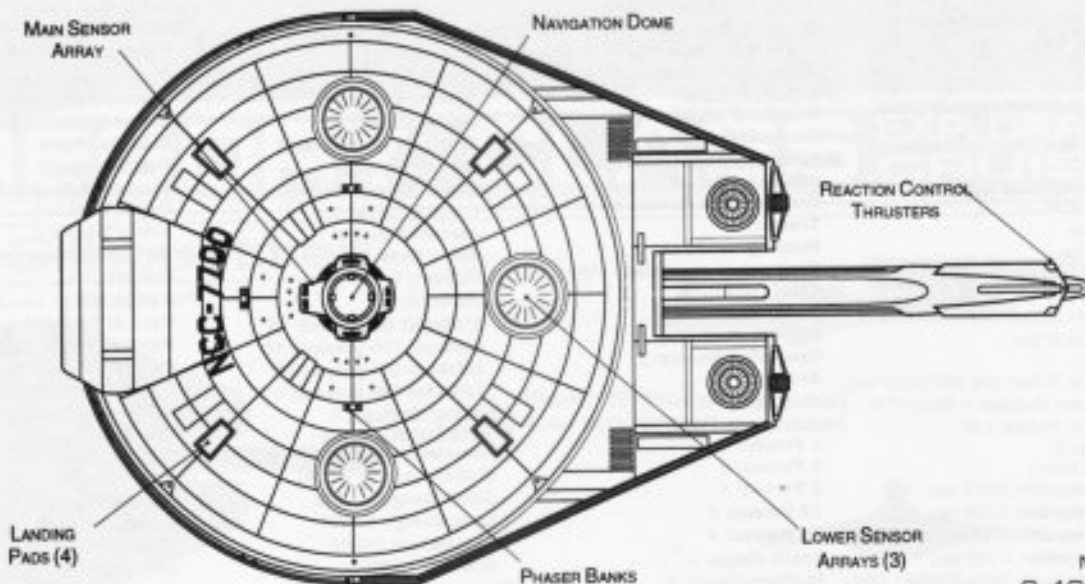

BOTTOM PROFILE

METERS
0 10 20 30 40 50
SCALE 1:2000

FEDERATION VESSEL



EXPLORATION CRUISER

Ship Names

THE FOLLOWING SHIPS OF THE MK-XXIV CLASS WERE AUTHORIZED BY THE AMENDED ARTICLES OF FEDERATION OF STARDATE 2270.11

ALESCH *NCC-7773	HAINES *NCC-7752	ODLE *NCC-7779	WALLIS *NCC-7776
ARANT *NCC-7708	HASELOFF *NCC-7717	PALMERO *NCC-7744	WARTON *NCC-7739
ARNOLD *NCC-7723	HEALD *NCC-7751	PEREZ *NCC-7724	WHITESIDE *NCC-7703
ARROYO *NCC-7718	IACUONE *NCC-7749	PEUGH *NCC-7747**	WIGGER *NCC-7780
BECKNER *NCC-7771	IBE *NCC-7720	PICKREL *NCC-7775	YAMAK *NCC-7781
BOTELER *NCC-7714	INMAN *NCC-7756	QUINONES *NCC-7719	YARINA *NCC-7734
BROOKER *NCC-7711**	JASO *NCC-7745	QUISENBERRY *NCC-7769	YESELL *NCC-7778
CAMPOSS *NCC-7768	JOLIVETTI *NCC-7760**	RACKLER *NCC-7716	ZIMBAL *NCC-7729
CHRISTOFFERSON *NCC-7706	JOSIE *NCC-7722	REDMAN *NCC-7763	
CHUNN *NCC-7721**	KEARBY *NCC-7742	ROMANE *NCC-7750	
DENNISSON *NCC-7726	KILLMER *NCC-7725	ROWEL *NCC-7754	
DIAMANT *NCC-7701	KLEPPER *NCC-7728	SADLER *NCC-7713	
DODKIN *NCC-7765	KNOBEL *NCC-7766	SAULK *NCC-7757	
DODSON *NCC-7705	LAMBERT *NCC-7741	SCHNIERS *NCC-7758**	
EAVES *NCC-7710	LAYNE *NCC-7731	SHEPPERD *NCC-7709	
ENLOE *NCC-7732	LESERVE *NCC-7772	SLEASER *NCC-7761	
ESCOBEDO *NCC-7762	LOGSDON *NCC-7735	STARKE *NCC-7707	
FOLTYN *NCC-7738	MAHURIN *NCC-7730	TEETERS *NCC-7704	
FONNER *NCC-7712**	MALDONADO *NCC-7777	TEMPLO *NCC-7753	
FRANKS *NCC-7759	MAUNUKSALA *NCC-7733	THEAMENS *NCC-7764	
GANDY *NCC-7755	McCANE *NCC-7727	TURNBOW *NCC-7767**	
GLENNGARY *NCC-7702	MONTROSS *NCC-7736	USRY *NCC-7748	
GONGORA *NCC-7715	NEMES *NCC-7737	VEITCH *NCC-7770	
GOODLOE *NCC-7745	NIEMANN *NCC-7782	VO *NCC-7774	
GREGORY *NCC-7700*	OAKELEY *NCC-7740	VRANA *NCC-7743	

*CLASS SHIP. **LOST IN THE LINE OF DUTY. ***PROPOSED. ALL NAMES PRECEDED WITH "U.S.S."

Tractor Beam Specifications

Primary Tractor Beam Load Calculator

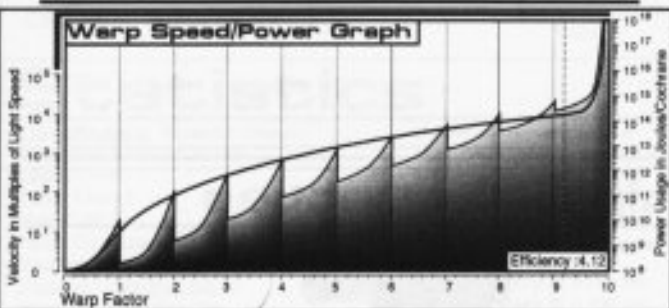
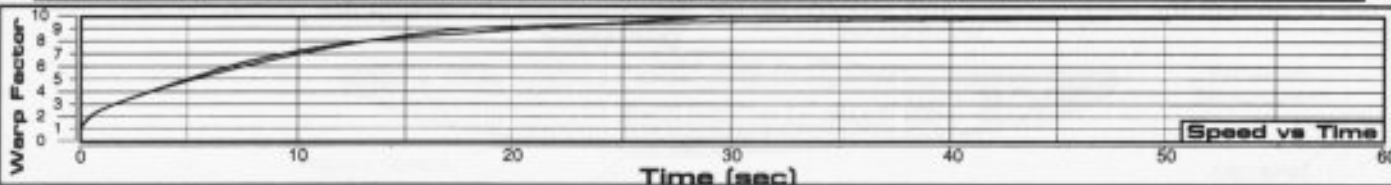
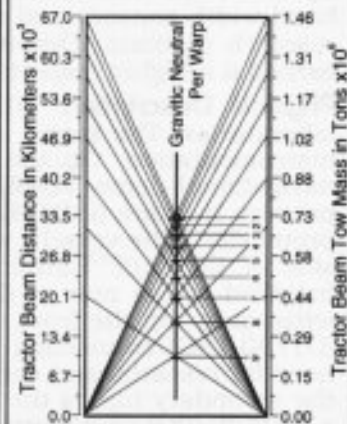

Field Length 832.95m
Field Width 93.18m
Field Height 82.56m



Front Warp Field Profile
Cross Section Area 12045.00 m²

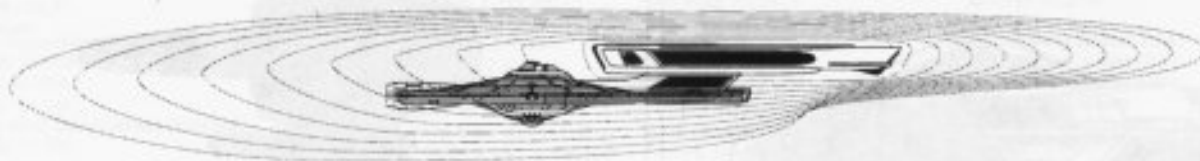

Port Warp Field Profile
Cross Section Area 36166.68 m²

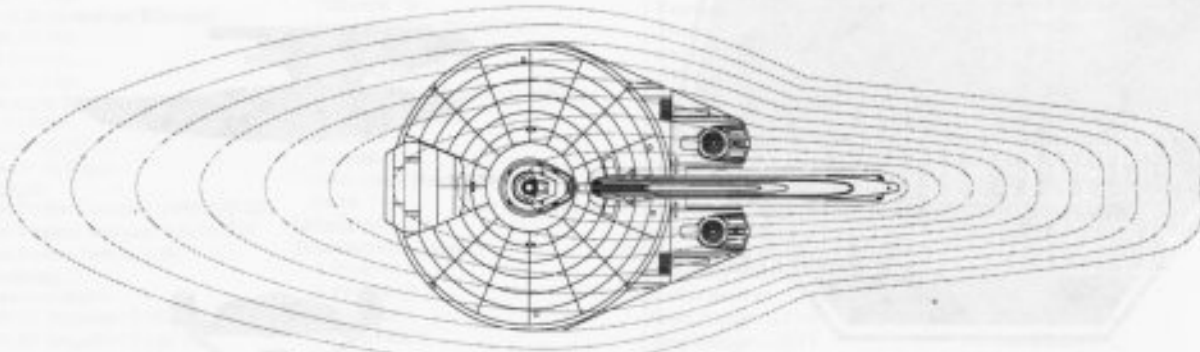

Top Warp Field Profile
Cross Section Area 79416.16 m²

WARP FIELDS

SRM2 04:05:01:04

STARFLEET REFERENCE MANUAL

GREGORY CLASS

FEDERATION VESSEL

RESEARCH VESSEL



OBERTH CLASS

General Information

Specific Role: The Research Vessel is a small efficient starship used for intensive research. Adjustable band-width sensors and extensive research laboratories throughout the vessel give it a comprehensive research platform. Despite this vessel's small size, its contributions to the research community have earned it a highly respectable reputation.

Physical Description: The (SH103/R-E4) ship is equipped with additional research systems and laboratories. The vessel is equipped with a (BF5/R-L5) bridge which incorporates additional research instrumentation. On the lower part of the hull is the (SM15/5T) main sensor array and (DN2/3D) navigational dome. Positioned forward of the bridge is a (BP2/30-2C) phaser bank. At the rear of the primary hull are (ISR10E/3-GF) dual impulse units which are used for auxiliary power and sub-warp propulsion. The vessel's warp fields are generated by two (SU38/1-2JL) warp nacelles attached to each side of the hull. Running horizontally between the nacelles is the (M20/1-2D) intermix chamber. Installed to the rear of the hull are the (AM3/15-2A) matter/antimatter storage tanks for emergency jettisoning. On the front of the hull is a small hangar deck. Slung underneath the primary hull by two (DT/30-15G) connecting dorsals is a (SH153/R-D2) secondary hull. The secondary hull is primarily used for research and contains most of the vessel's sensors and research facilities. On the lower front of the secondary hull is the (SME256/3D) primary sensor array. Facing rearward on the secondary hull is a (SME79/9Q) secondary sensor array. In the event of an emergency, the primary hull can separate from one or both of the warp nacelles and proceed on the remaining nacelle or impulse power.

Class Emblem



Ship Silhouettes

Total Target Area 13144.36 m²



Top Silhouette
Area 7753.18 m²



Port Silhouette
Area 3899.4 m²



Front Silhouette
Area 1491.80 m²

FEDERATION VESSEL



RESEARCH VESSEL

OBERTH CLASS

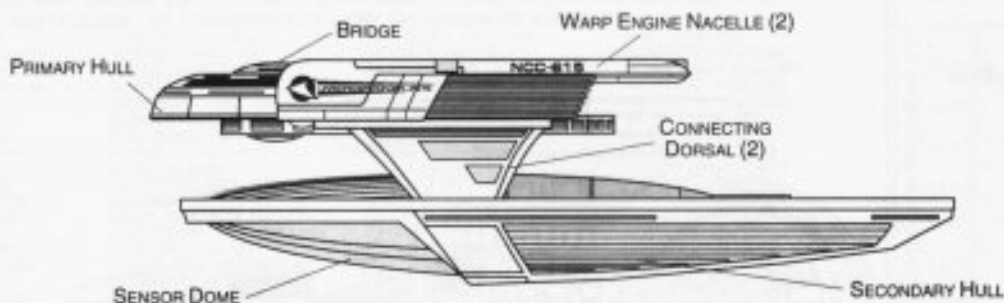

PORT PROFILE

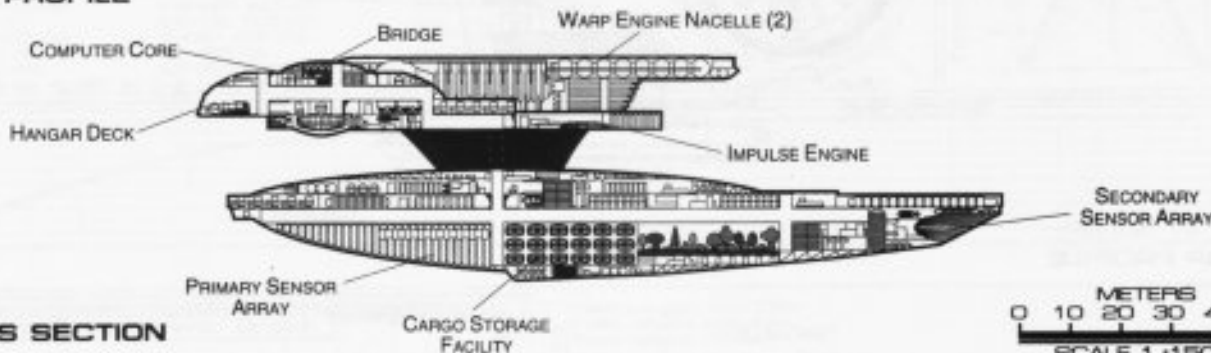

CROSS SECTION

Statistics

Classification: Research Vessel

Category: Research Vessel

Class: Oberth

Type: Class 2

Model: MK-V

Naval Construction Contract: 600

Number Proposed: 99

Number Constructed: 96

Number in Service: 94

Number Lost: 2

Dimensions:

Overall Dimensions (Meters)

Length: 159.83m

Width: 82.97m

Height: 44.34m

Primary Hull Dimensions (Meters)

Length: 92.73m

Width: 82.97m

Height: 15.22m

Secondary Hull Dimensions (Meters)

Length: 153.72m

Width: 21.94m

Height: 22.20m

Warp Unit Dimensions (Meters)

Length: 83.09m

Width: 10.85m

Height: 12.17m

Displacement (Metric Tons)

Light: 37,438mt

Standard: 40,111mt

Full Load: 44,776mt

Performance:

Impulse Units: Dual Unit (ISR10E/3-GF)

Impulse Engine Output: 6.0×10^{12} W

Impulse Power Index: 4.92

Max Cruising: C

Acceleration Rate:

0.00-0.25 Impulse: 0.162 sec.

0.25-0.50 Impulse: 0.244 sec.

0.50-0.75 Impulse: 0.325 sec.

0.75-Full Impulse: 0.406 sec.

Warp Units: 2 Nacelle Units (SU38/1-2JL)

Warp Engine Output: 1.92×10^{14} W

Warp Power Index: 0.79

Optimum Speed: Warp 4

Max. Safe Cruising: Warp 5

Emergency Speed: Warp 7

Max. Speed: Warp 8

Destructive Speed: Warp 8.5

Acceleration Power: 3.0

Acceleration Times:

Warp 1 - Warp 2: 0.254 sec.

Warp 2 - Warp 3: 0.406 sec.

Warp 3 - Warp 4: 1.529 sec.

Warp 4 - Warp 5: 2.208 sec.

Warp 5 - Warp 6: 2.360 sec.

Warp 6 - Warp 7: 2.551 sec.

Warp 7 - Warp 8: 3.274 sec.

Warp 8 - Warp 9: 4.683 sec.

Warp 9 - Warp 9.5: 10.406 sec.

Warp 9.5 - Warp 9.75: 12.056 sec.

Warp 9.75 - Warp 9.9: 25.000 sec.

Duration (Years)

Standard: 6 Years

Maximum: 24 Years

Std. Ships Complement: 111

Officers: 18

Crew (Ensign Grade): 90

Troops: 3

Passengers: 10

Emergency condition: +150

Medical Facilities:

Doctors: 2

Nurses: 11

Operating Rooms: 2

Beds: 11

Laboratories: 6

Transporters Total: 2

1 Person: 0

2 Person: 0

6 Person: 1

12 Person: 0

22 Person: 1

Small Cargo: 0

Medium Cargo: 0

Large Cargo: 0

Super Cargo: 0

Brigs: 2

Replicators: 3

Tractor Beams: 1

Tow Capacity: 8.83×10^5 mt

Max Range: 4.40×10^4 km

Cargo Specification:

Standard Cargo Units: 70

Cargo Capacity: 3,500mt

Shuttlecraft Specifications:

Docking Ports: 1

Shuttlecraft Bays Total: 1

Small Bay: 1

Medium Bay: 0

Large Bay: 0

Super Bay: 0

Shuttlecraft Standard: 15

Work Bees: 1

Travel Pods: 0

Aquatic Shuttle: 0

Light Shuttle: 1

Standard Shuttle: 3

Survey Shuttle: 3

Heavy Shuttle: 0

Cargo Shuttle: 1

Assault Shuttle: 4

Killer Bees: 1

Fighter: 0

Lifeboats: 11

Turbolift (8 person): 10

Lifeboat (10 person): 1

Lifeboat (20 person): 0

Lifeboat (30 person): 0

Cloaking Devices: 0

Sensor Index Values:

Planetary Survey: 0.8979

Stellar Survey: 1.5759

Short Range: 0.7147

Long Range: 1.2543

Navigation: 0.3980

Special: 0.3465

Computers: 2

Type: Daystrom Duotronic II:d

Type: Daystrom Duotronic II:c

ECM Index: 0.89

Shield Rating:

Shield Index: 3.57

Holdoff Power: 2.35×10^{12} W

Refresh Rate: 6.68×10^{11} W

Breakdown Rate: 8.01×10^{11} W

Shield Dimensions (Meters)

Length: 191.80m

Width: 99.56m

Height: 53.21m

Weapons:

Phaser Power Index: 0.547

Photon Power Index: 0.00

Vessel Power Index: 0.270

Weapon Placement:

Beam (Phasers) Total: 1 banks 2 each

Output: 5.0×10^{11} W / 2.5×10^{11} W

Range: 2.5×10^5 km

Rate of Fire: 30 ppm / Cont.

Forward Banks: 1

Rear Banks: 0

Port Banks: 0

Starboard Banks: 0

Upper Banks: 0

Lower Banks: 0

Beam (MegaPhasers) Total: 0

Output: N/A

Range: N/A

Rate of Fire: N/A

Forward/Rear Banks: 0

Port/Starboard Banks: 0

Upper/Lower Banks: 0

Torpedoes (Photon) Total: N/A

Stock: N/A

Range: N/A

Output: N/A

Rate of Fire: N/A

Forward Bay: 0

Rear Bay: 0

Port Bay: 0

Starboard Bay: 0

Upper Bay: 0

Lower Bay: 0

FEDERATION VESSEL

RESEARCH VESSEL



OBERTH CLASS

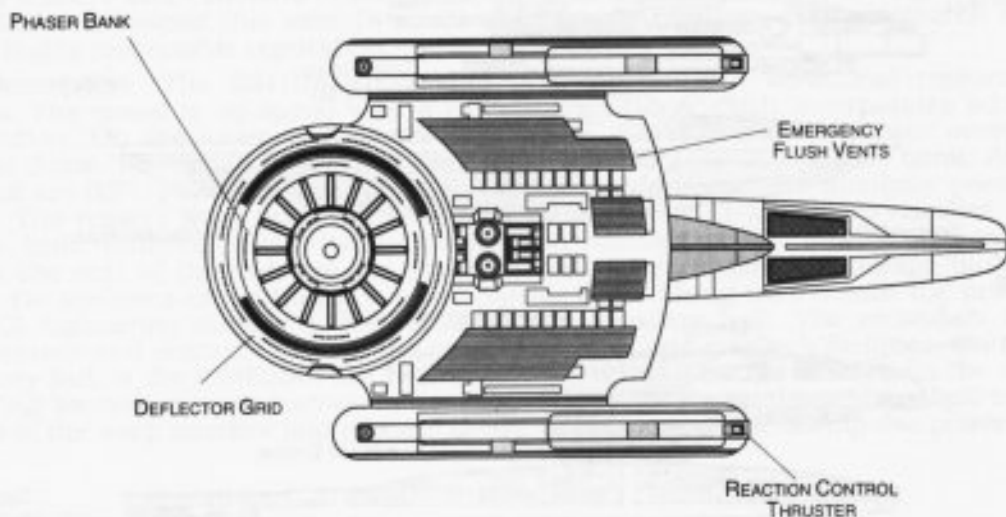

TOP PROFILE

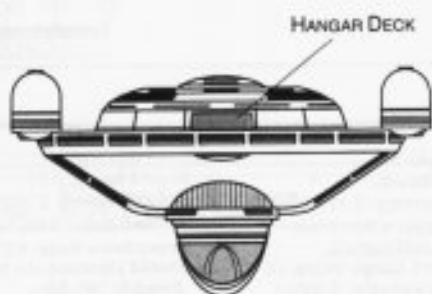

FRONT PROFILE

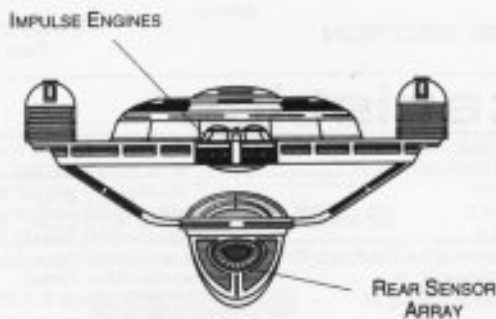

REAR PROFILE

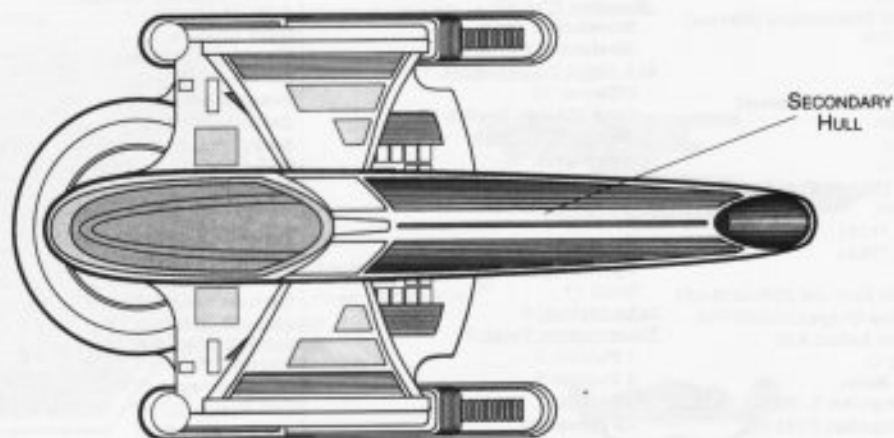

BOTTOM PROFILE

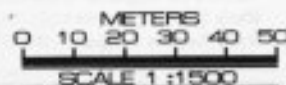

FEDERATION VESSEL

RESEARCH VESSEL



Ship Names

THE FOLLOWING SHIPS OF THE MK-V CLASS WERE AUTHORIZED BY THE AMENDED ARTICLES OF FEDERATION OF STARDATE 2266.2

CARPEN *NCC-633	JARAMILLO *NCC-671	NORVELLE *NCC-688	RIOZ *NCC-620
COCHRANE *NCC-59318	JEZESICK *NCC-687	NOWELL *NCC-643	ROBINETT *NCC-640
COOPER *NCC-635	KNODE *NCC-692	NUEGEBAUER *NCC-691	RONHAUSEN *NCC-655
COPERNICUS *NCC-623	KOPP *NCC-677	NZERE *NCC-685	ROTAURIS *NCC-682
EASTER *NCC-636	KRUSINSKY *NCC-645	OBERTH *NCC-615*	ROUSSEAU *NCC-670
ESPINOSA *NCC-611	KUBOTA *NCC-601	OLIPHANT *NCC-625	SAPIEN *NCC-663
FARRIER *NCC-622	KUO-CHING *NCC-667	OMOHUNDRO *NCC-676	SATO *NCC-680
FILLIPONE *NCC-616	KURATKO *NCC-619	ORUM *NCC-683	SCHIRRA *NCC-634
FIRSICK *NCC-604	KYRE *NCC-656	OTT *NCC-658	SCRIBNER *NCC-673
GAGARIN *NCC-630	LACROSSE *NCC-674	OWNYO *NCC-668	SHEPARD *NCC-631
GALLAWAY *NCC-628	LALONDE *NCC-662	OYEN *NCC-610	SPARLING *NCC-678
GARIBALDO *NCC-607	LIBBY *NCC-653	O'QUINN *NCC-689	STAFFORD *NCC-618
GLENN *NCC-632	LINDSTROM *NCC-603	PAIZ *NCC-617	STANDRIDGE *NCC-612
GRISSOM *NCC-638**	LINEUM *NCC-627	PARISI *NCC-606	STRAUB *NCC-614
HALVERSON *NCC-602	LIN-CHI-PAN *NCC-609	PARKHILL *NCC-624	TARKENTON *NCC-659
HAMPTON *NCC-613	LOCKHART *NCC-649	PARUCHURI *NCC-641	TERESHKOVA *NCC-637
HARDGRAVE *NCC-694***	LOWDERMILK *NCC-684	PATENTOTE *NCC-666	THAXTON *NCC-644
HARINDEN *NCC-626	LOX *NCC-693***	PAVELKA *NCC-608	TITOV *NCC-639
HARRINGER *NCC-681	MAGEE *NCC-690	PEACOCK *NCC-654	TOSCANO *NCC-650
HARTGRAVES *NCC-642	MAKEWICZ *NCC-669	PEIKERT *NCC-686	TSIOLKOVSKY *NCC-53911**
HARVISON *NCC-664	MANAHAN *NCC-657	PUTUMBAKA *NCC-621	VASEK *NCC-652
HASS *NCC-651	MARQUIS *NCC-605	QAZI *NCC-646	VICO *NAR-18834**
INGLESIA *NCC-629	McADEN *NCC-679	QUATTLEBAUM *NCC-672	VILLALOBOS *NCC-648
IRONS *NCC-647	NIX *NCC-695	QUINN *NCC-681	YOSEMITE *NCC-19002
JANOW *NCC-650	NONWEILER *NCC-675	REAGOR *NCC-600	

*CLASS SHIP, †LOST IN THE LINE OF DUTY, **PROPOSED, ALL NAMES PRECEDED WITH "U.S.S."

Tractor Beam Specifications

Primary Tractor Beam Load Calculator

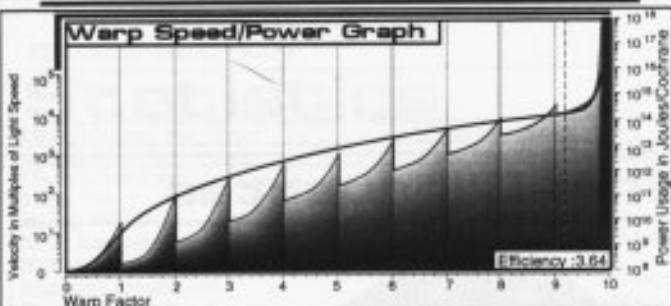
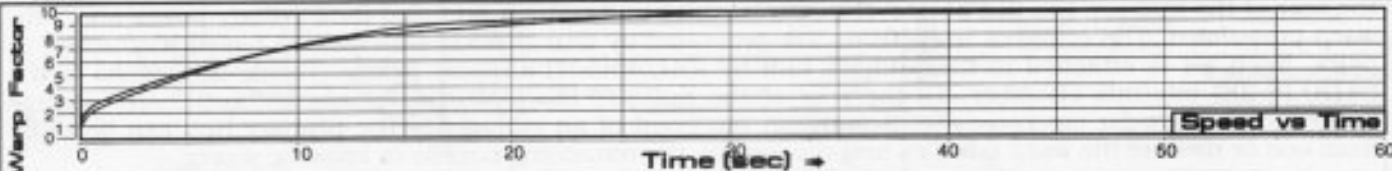
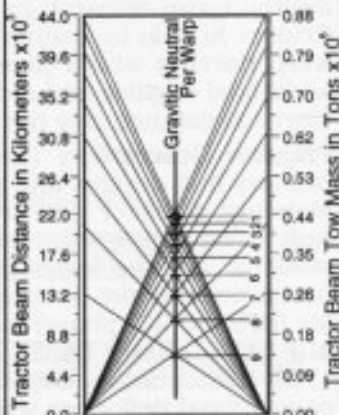

Field Length 495.37m
Field Width 116.43m
Field Height 79.44m

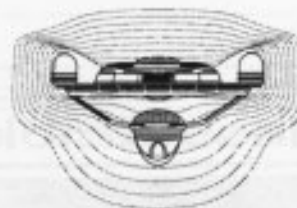

Front Warp Field Profile

Cross Section Area 7208.00 m²

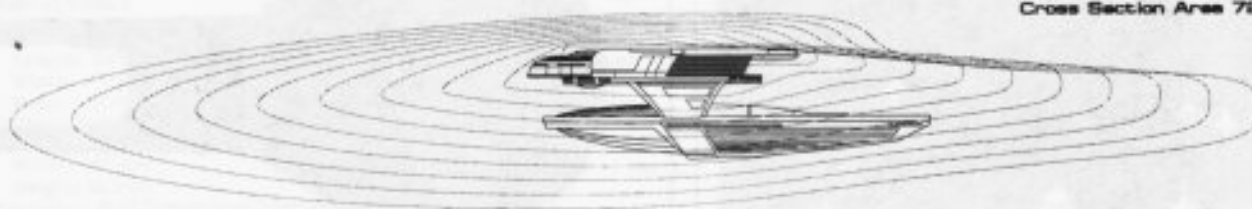

Port Warp Field Profile

Cross Section Area 28918.76 m²

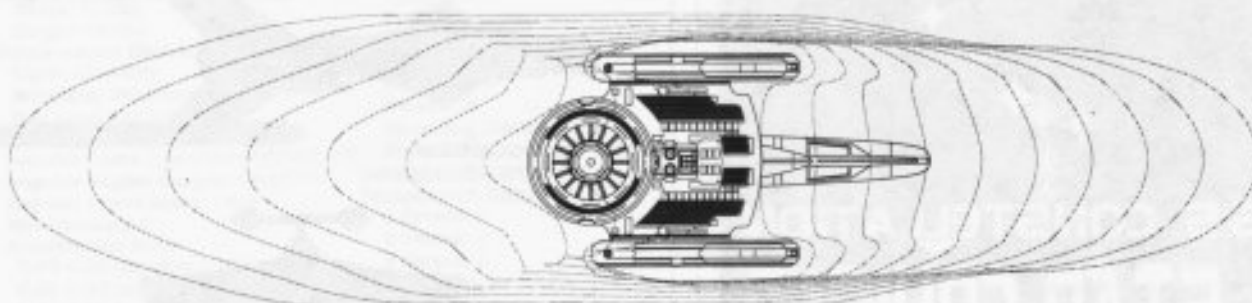

Top Warp Field Profile

Cross Section Area 46597.20 m²

WARP FIELDS

SRM2 04:05:02:04

STARFLEET REFERENCE MANUAL

OBERTH CLASS

FEDERATION VESSEL

STAR CRUISER



CONSTELLATION CLASS

General Information

Specific Role: The Star Cruiser is a long range exploration research vessel. This vessel is equipped with six multipurpose research bays that allow various experiments and sensors to be exposed to space. The Star Cruiser is able to maintain sustained warp speeds for extended periods of time through the use of four warp nacelles which phase-shift through alternating pairs to reduce the stress to any one engine. The additional engines and redundant equipment allow the cruiser to explore areas away from Federation space where assistance may not be immediately available.

Physical Description: The Star Cruiser's extra-thick (XTPH147/F-M1) hull uses elements from standard primary hull designs and is equipped with additional research systems and laboratories. Integrated into the standard deflector grid are additional electronic counter-measures to make the vessel more stealthy. The hull is equipped with the (BS11/S-D3) bridge which incorporates the enhanced sensor and scientific stations. On the lower part of the primary hull is the (SM54/9K) main sensor array and (DN6/1-V) navigational dome. Located on the port, starboard and bow of the primary hull (both top and bottom) are six (BP2/30-2C) phaser banks. To the front of the primary hull both port and starboard are two (HP2/22-2G) heavy phaser banks. Incorporated into the nacelle support pylons are forward and rear firing (PB1-1/50-10E) photon torpedo tubes. On the lower forward section of the primary hull are (DN6/A-9) navigational deflectors which assist the navigational shields in deflecting oncoming debris. To the front of the primary hull is a medium hangar deck. Around the primary hull are six multipurpose research bays. To the rear of the hull are two (IRF35E/5-TR) dual impulse units which are used for auxiliary power and sub-warp propulsion. The cruiser's warp fields are generated by four (SW52/1-5RT) warp nacelles attached in pairs. Each set is attached to the primary hull by (DU/40-30T) support pylons. Inside the pylons is the (M18/12-2E) intermix chamber. To the rear of the hull are the (AM8/58-7S) matter/antimatter storage tanks which allow for emergency jettisoning. In the event of an emergency the primary hull can separate from one or more of the warp nacelles and proceed on the remaining nacelle or impulse power.

Class Emblem



Ship Silhouettes

Total Target Area 48318.04 m²



Top Silhouette
Area 32031.58 m²



Port Silhouette
Area 11707.72 m²



Front Silhouette
Area 5578.76 m²

FEDERATION VESSEL



STAR CRUISER

CONSTELLATION CLASS

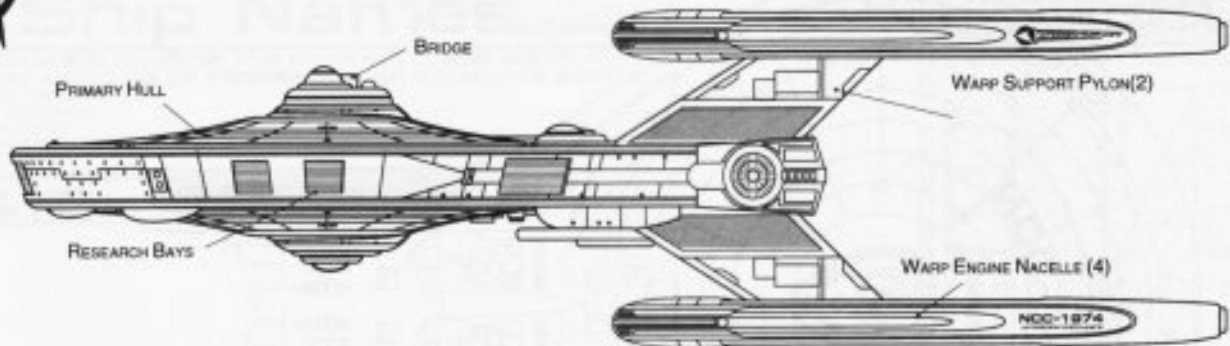

PORT PROFILE

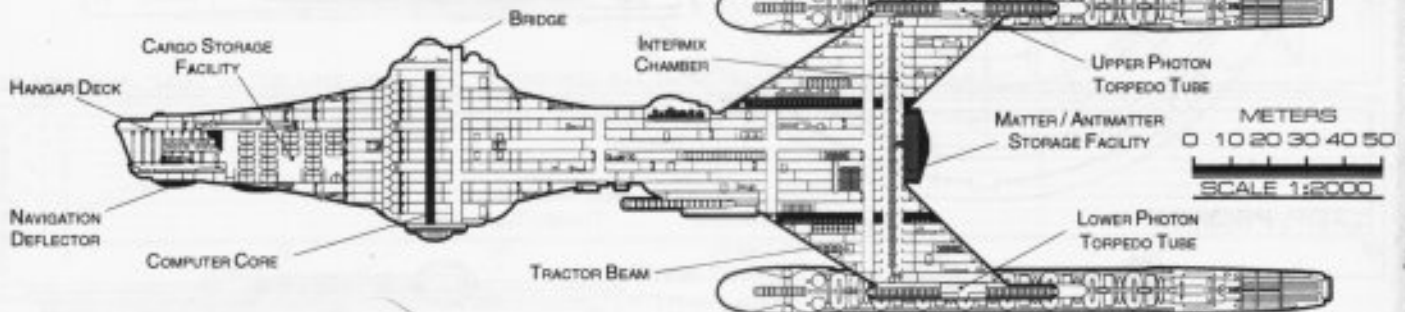

CROSS SECTION

Statistics

Classification: Star Cruiser
Category: Research Vessel
Class: Constellation
Type: Class 1
Model: MK-XXVI
Naval Construction Contract: 1974
Number Proposed: 9
Number Constructed: 9
Number in Service: 7
Number Lost: 2

Dimensions:
Overall Dimensions (Meters)
 Length: 305.97m
 Width: 161.89m
 Height: 84.50m
Primary Hull Dimensions (Meters)
 Length: 205.18m
 Width: 161.88m
 Height: 50.91m
Secondary Hull Dimensions (Meters)
 Length: N/A
 Width: N/A
 Height: N/A

Warp Unit Dimensions (Meters)
 Length: 155.59m
 Width: 12.63m
 Height: 18.32m
Displacement (Metric Tons)
 Light: 332,449mt
 Standard: 356,182mt
 Full Load: 397,613mt

Performance:
Impulse Units: 2 Dual Unit (IRF35E/5-TR)
Impulse Engine Output: 1.6×10^{14} W
Impulse Power Index: 1.034
Max Cruising: C
Acceleration Rate:
 0.00-0.25 Impulse: 0.180 sec.
 0.25-0.50 Impulse: 0.270 sec.
 0.50-0.75 Impulse: 0.361 sec.
 0.75-Full Impulse: 0.451 sec.
Warp Units: 4 Nacelle Units (SW54/1-SUI)
Warp Engine Output: 2.4×10^{15} W
Warp Power Index: 1.11

Optimum Speed: Warp 6
Max. Safe Cruising: Warp 8.1
Emergency Speed: Warp 9
Max. Speed: Warp 9.25
Destructive Speed: Warp 9.35
Acceleration Power: 3.0
Acceleration Times:
 Warp 1 - Warp 2: 0.180 sec.
 Warp 2 - Warp 3: 0.288 sec.
 Warp 3 - Warp 4: 1.091 sec.
 Warp 4 - Warp 5: 1.569 sec.
 Warp 5 - Warp 6: 1.677 sec.
 Warp 6 - Warp 7: 1.812 sec.
 Warp 7 - Warp 8: 2.326 sec.
 Warp 8 - Warp 9: 3.327 sec.
 Warp 9 - Warp 9.5: 7.393 sec.
 Warp 9.5 - Warp 9.75: 8.565 sec.
 Warp 9.75 - Warp 9.9: 17.760 sec.

Duration (Years)
 Standard: 7 Years
 Maximum: 28 Years
Std. Ships Complement: 532
 Officers: 85
 Crew (Ensign Grade): 416
 Troops: 31
 Passengers: 90
 Emergency condition: +500
Medical Facilities:
 Doctors: 5
 Nurses: 26
 Operating Rooms: 4
 Beds: 26

Laboratories: 23
Transporters Total: 12
 1 Person: 0
 2 Person: 0
 6 Person: 4
 12 Person: 0
 22 Person: 4
 Small Cargo: 2
 Medium Cargo: 2
 Large Cargo: 0
 Super Cargo: 0

Brigs: 22
Replicators: 27
Tractor Beams: 1
 Tow Capacity: 3.88×10^6 mt
 Max Range: 1.94×10^9 km
Cargo Specifications:
 Standard Cargo Units: 558
 Cargo Capacity: 27,900mt
Shuttlecraft Specifications:
 Docking Ports: 3
Shuttlecraft Bays Total: 1
 Small Bay: 0
 Medium Bay: 1
 Large Bay: 0
 Super Bay: 0
Shuttlecraft Standard: 31
 Work Bees: 2
 Travel Pods: 1
 Aquatic Shuttle: 3
 Light Shuttle: 3
 Standard Shuttle: 10
 Survey Shuttle: 10
 Heavy Shuttle: 0
 Cargo Shuttle: 1
 Assault Shuttle: 0
 Killer Bees: 0
 Fighter: 3
 Lifeboats: 35
 Turbolift (8 person): 24
 Lifeboat (10 person): 7
 Lifeboat (20 person): 3
 Lifeboat (30 person): 1
Cloaking Devices: 0
Sensor Index Values:
 Planetary Survey: 1.5679
 Stellar Survey: 1.5909
 Short Range: 1.3065
 Long Range: 1.3256
 Navigation: 1.1040
 Special: 1.7811
Computers: 2
 Type: Daystrom Duotronic IVa
 Type: Daystrom Duotronic IIIc

ECM Index: 1.25
Shield Rating:
 Shield Index: 0.62
 Holdoff Power: 3.60×10^{12} W
 Refresh Rate: 1.02×10^{12} W
 Breakdown Rate: 1.23×10^{12} W
Shield Dimensions (Meters)
 Length: 386.50m
 Width: 204.49m
 Height: 106.74m
Weapons:
Phaser Power Index: 1.43
Photon Power Index: 1.02
Vessel Power Index: 1.23
Weapon Placement:
Beam (Phasers) Total: 6 banks 2 each
 Output: 5.0×10^{11} W / 2.5×10^{11} W
 Range: 2.5×10^9 km
 Rate of Fire: 30 ppm / Cont.
 Forward Banks: 2
 Rear Banks: 0
 Port Banks: 2
 Starboard Banks: 2
 Upper Banks: 0
 Lower Banks: 1
Beam (HvyPhasers) Total: 2 banks 2 each
 Output: 1.3×10^{12} W / 6.5×10^{11} W
 Range: 8.9×10^9 km
 Rate of Fire: 10 ppm / Cont.
 Forward/Rear Banks: 0
 Port/Starboard Banks: 2
 Upper/Lower Banks: 0
Torpedoes (Photon) Total: 2 Bay 2 each
 Stock: 80
 Range: 2.0×10^5 km
 Output: 10-50 Megatons
 Rate of Fire: 10 spm
 Forward Bay: 2
 Rear Bay: 2
 Port Bay: 0
 Starboard Bay: 0
 Upper Bay: 0
 Lower Bay: 0

FEDERATION VESSEL

STAR CRUISER



CONSTELLATION CLASS

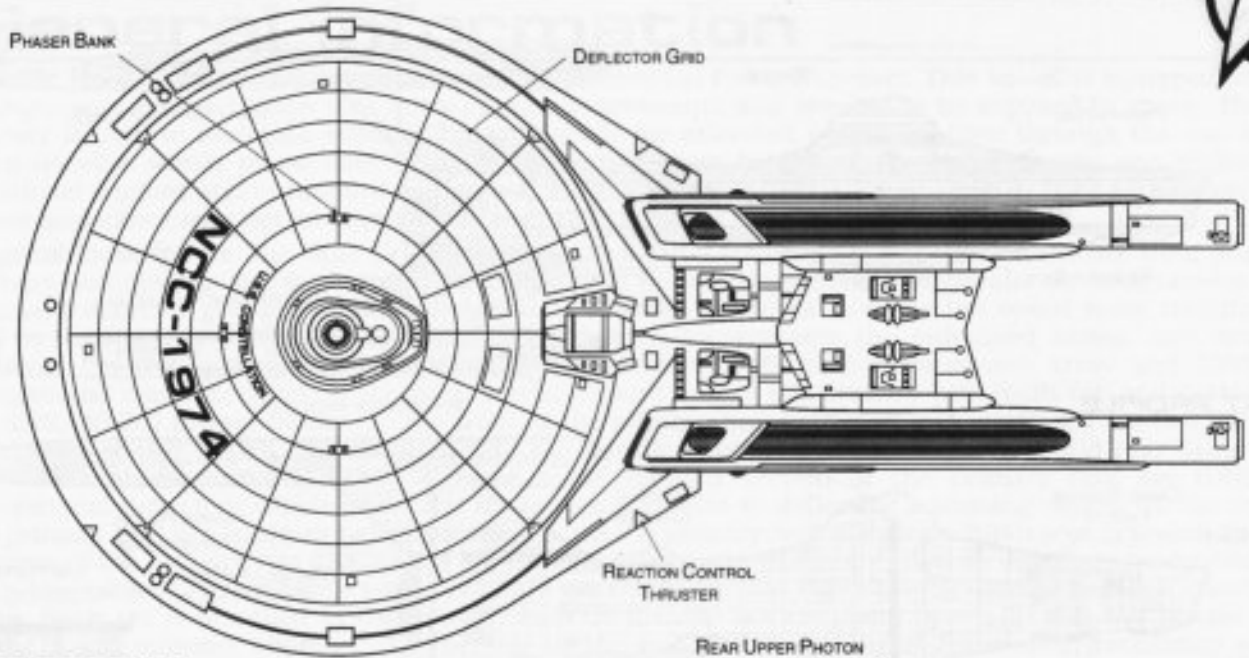

TOP PROFILE

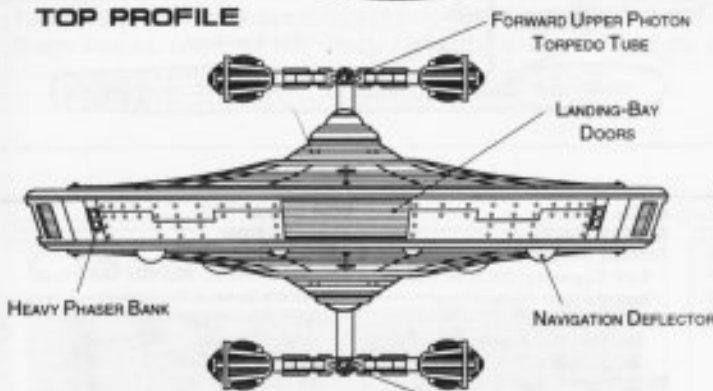

FRONT PROFILE

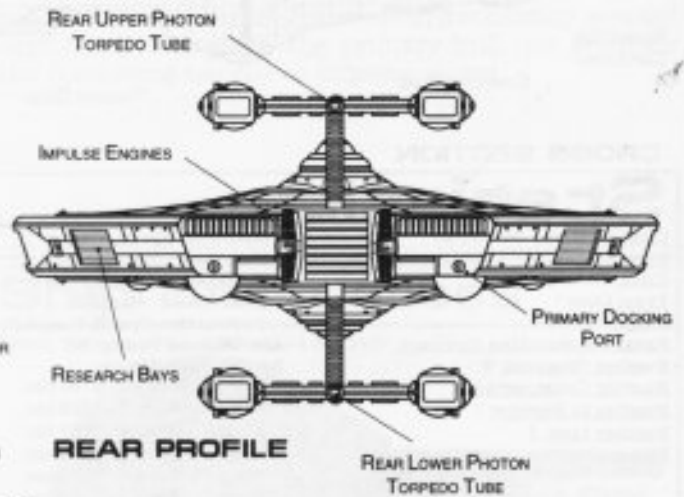

REAR PROFILE

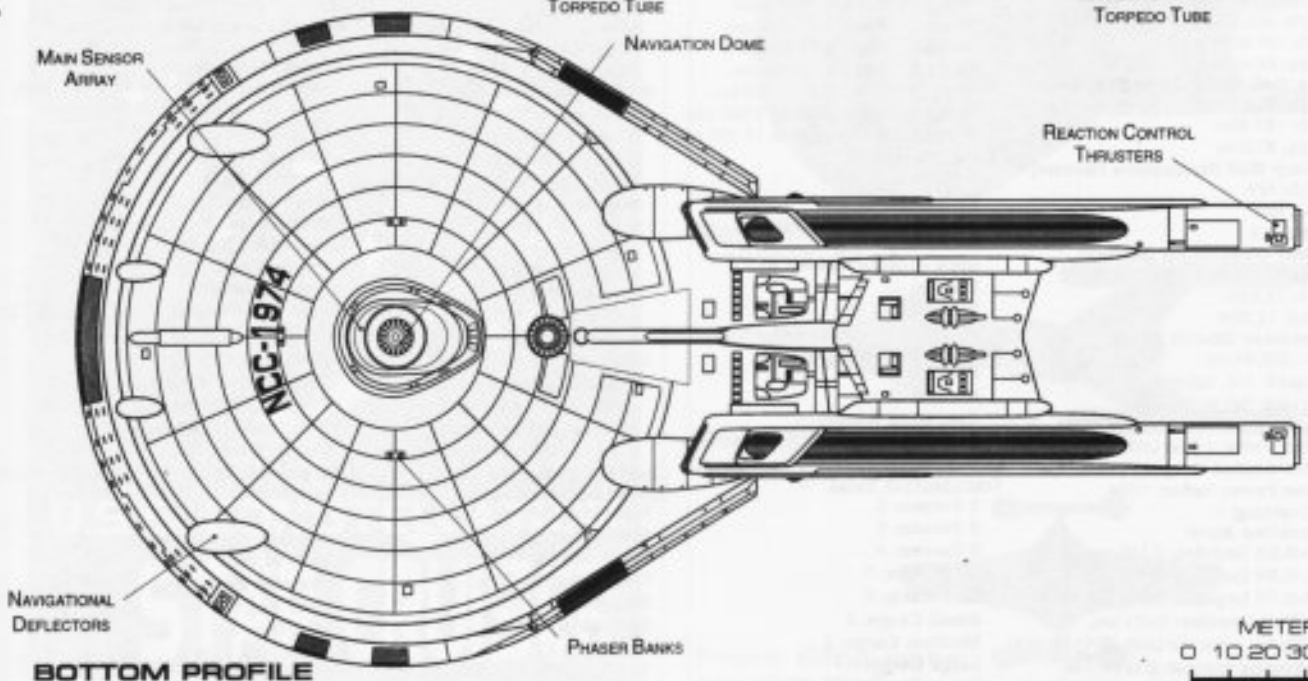

BOTTOM PROFILE

METERS
0 10 20 30 40 50
SCALE 1:2000

FEDERATION VESSEL



STAR CRUISER

Ship Names

THE FOLLOWING SHIPS OF THE MK-XXVI CLASS WERE AUTHORIZED BY THE AMENDED ARTICLES OF FEDERATION OF STARDATE 2285.1

- CONSTELLATION *NCC-1974*
- GETTYSBURG *NCC-38902
- HATHAWAY *NCC-2593
- LIENTORARY *NCC-5371
- NEBULARY *NCC-1442
- ODAY *NCC-28850
- STARGAZER *NCC-2893**
- STARQUEST *NCC-2894**
- VICTORY *NCC-9754

*CLASS SHIP. **LOST IN THE LINE OF DUTY. ***PROPOSED. ALL NAMES PRECEDED WITH "U.S.S."

Tractor Beam Specifications

Primary Tractor Beam Load Calculator

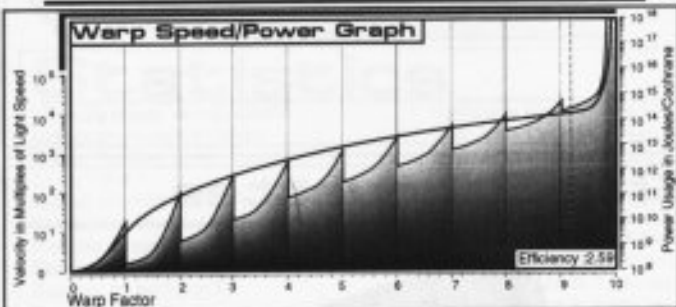
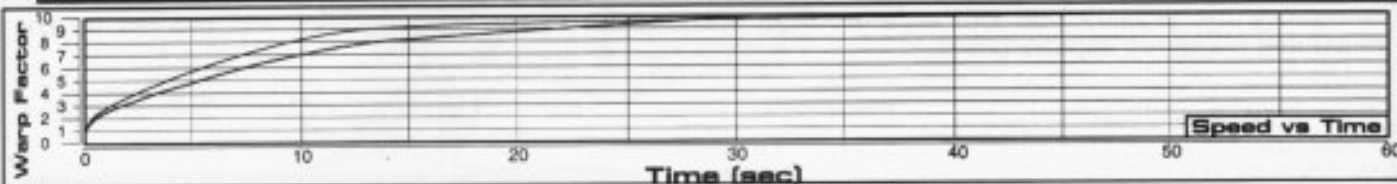
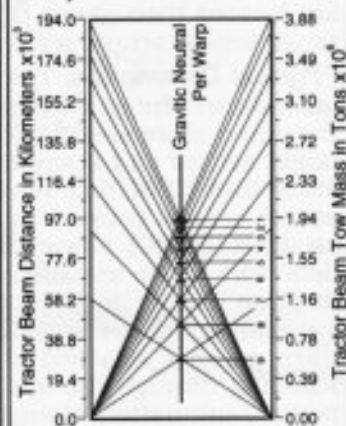

Field Length 737.74m
 Field Width 220.48m
 Field Height 117.49m

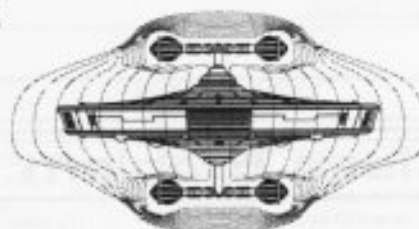

Front Warp Field Profile
 Cross Section Area 17949.52 m²

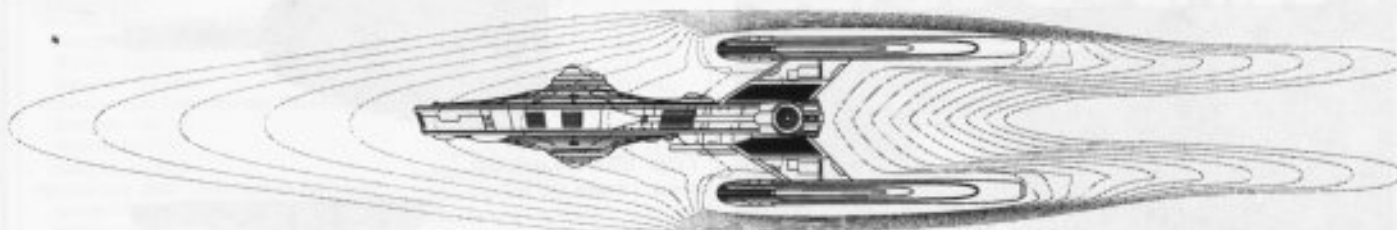

Port Warp Field Profile
 Cross Section Area 58473.36 m²

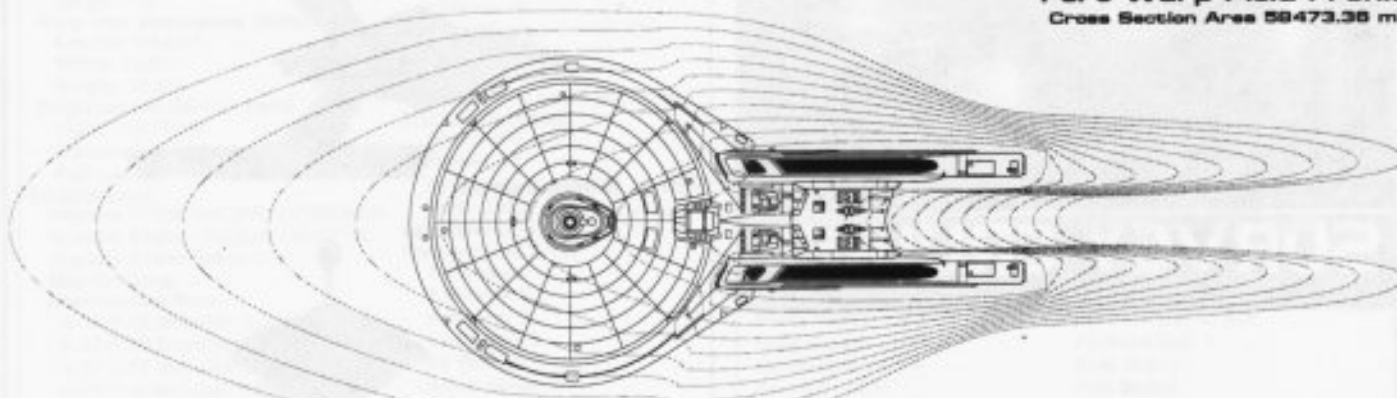

Top Warp Field Profile
 Cross Section Area 105548.56 m²

WARP FIELDS

SURVEY CRUISER



PLEIADES CLASS

General Information

Specific Role: The Survey Cruiser is designed to explore and study stellar anomalies. Extensive laboratories are located throughout the vessel which gives it a large research base. The vessel is equipped with long-range sensor arrays designed for stellar exploration and deep space charting.

Physical Description: The (PHB143/R-E6) primary hull is equipped with additional research systems and laboratories. Integrated into the standard deflector grid are additional electronic counter-measures to make the vessel more stealthy. The primary hull is equipped with the (BS12/R-E1) bridge which incorporates the larger sensor and scientific stations. On the lower part of the primary hull is the (SM49/8K) main sensor array and (DN4/5-L) navigational dome. On the bottom of the primary hull is the (SME222/3F) lower sensor arrays. Located on the port, starboard, bow and stern of the primary hull (both top and bottom) are six (BP2/30-2C) phaser banks. On the lower front of the primary hull are the (DN1/F-4) navigational deflectors which assist the navigational shields in deflecting oncoming debris. On each side of the hull is a medium hangar deck. To the rear of the primary hull are (IP186E/5-DF) dual impulse units which are used for auxiliary power and sub-warp propulsion. The vessel's warp fields are generated by two (SW52/1-5GG) warp nacelles attached to the upper and lower side of the primary hull by (DU/38-34F) support pylons. Running through the hull and connecting dorsals is the (M30/4-4F) intermix chamber. The (AM8/36-3G) matter/antimatter storage tanks are located below the impulse engines for emergency jettisoning. Positioned between the navigational deflectors is a (PB2/25-10G) photon torpedo bay. In the event of an emergency the primary hull can separate from one or both of the warp nacelles and proceed on the remaining nacelle or impulse power.

Class Emblem

PLEIADES CLASS



SURVEY CRUISER

Ship Silhouettes

Total Target Area 28685.36 m²



Top Silhouette
Area 13484.00 m²



Port Silhouette
Area 11278.20 m²



Front Silhouette
Area 3925.16 m²

FEDERATION VESSEL



SURVEY CRUISER

PLEIADES CLASS

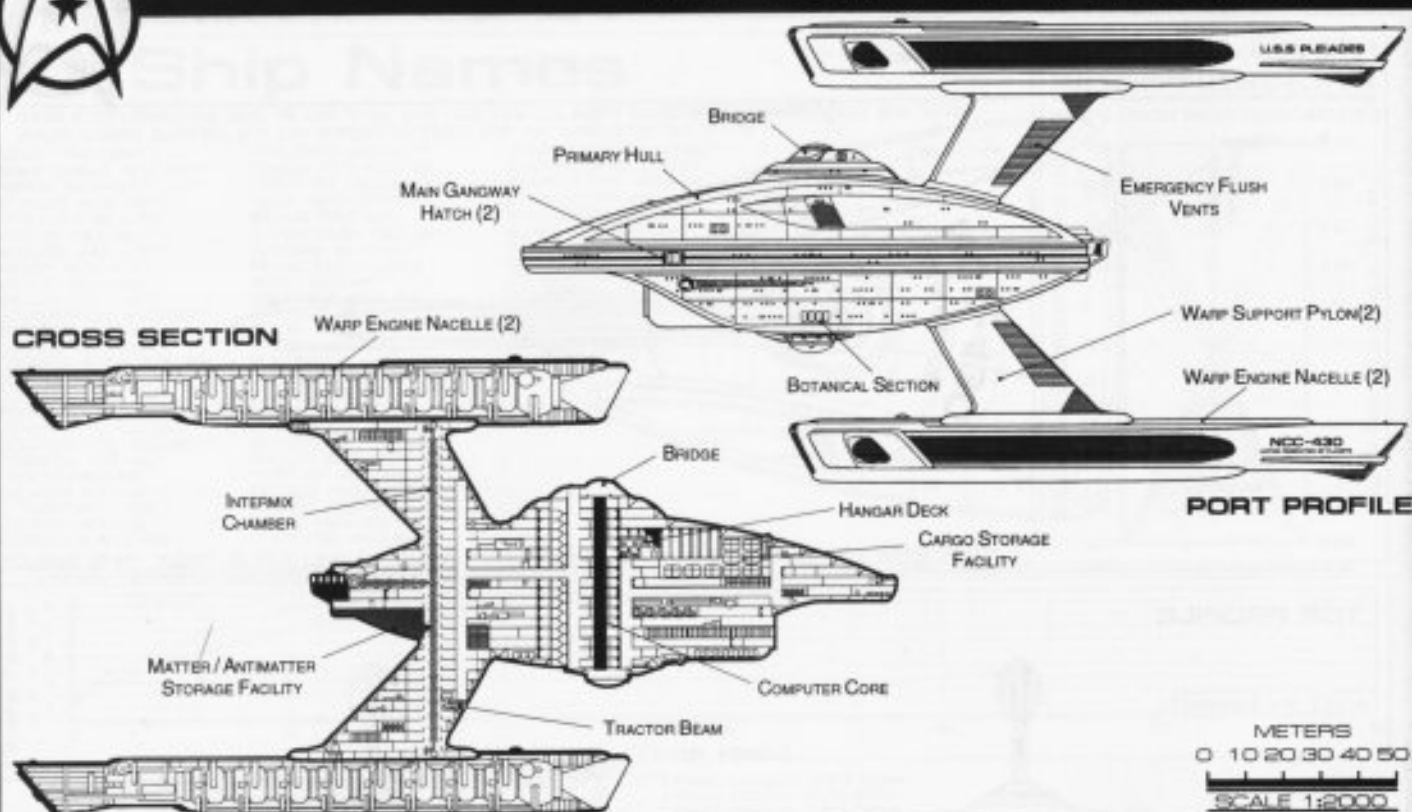

Statistics

Classification: Survey Cruiser

Category: Research Vessel

Class: Pleiades

Type: Class 1

Model: MK-XXXIV

Naval Construction Contract: 430

Number Proposed: 63

Number Constructed: 31

Number in Service: 25

Number Lost: 6

Dimensions:

Overall Dimensions (Meters)

Length: 215.00m

Width: 92.30m

Height: 112.80m

Primary Hull Dimensions (Meters)

Length: 143.10m

Width: 92.30m

Height: 51.50m

Secondary Hull Dimensions (Meters)

Length: N/A

Width: N/A

Height: N/A

Warp Unit Dimensions (Meters)

Length: 154.81m

Width: 12.63m

Height: 18.32m

Displacement (Metric Tons)

Light: 143,772mt

Standard: 154,036mt

Full Load: 171,953mt

Performance:

Impulse Units: Dual Unit (IRF35E/5-DF)

Impulse Engine Output: 7.8×10^{13} W

Impulse Power Index: 1.28

Max Cruising: C

Acceleration Rate:

0.00-0.25 Impulse: 0.156 sec.

0.25-0.50 Impulse: 0.234 sec.

0.50-0.75 Impulse: 0.312 sec.

0.75-Full Impulse: 0.390 sec.

Warp Units: 2 Nacelle Units (SE52/1-5GG)

Warp Engine Output: 1.2×10^{15} W

Warp Power Index: 1.28

Optimum Speed: Warp 4

Max. Safe Cruising: Warp 6

Emergency Speed: Warp 8

Max. Speed: Warp 9.1

Destructive Speed: Warp 9.25

Acceleration Power: 3.0

Acceleration Times:

Warp 1 - Warp 2: 0.156 sec.

Warp 2 - Warp 3: 0.250 sec.

Warp 3 - Warp 4: 0.944 sec.

Warp 4 - Warp 5: 1.357 sec.

Warp 5 - Warp 6: 1.450 sec.

Warp 6 - Warp 7: 1.567 sec.

Warp 7 - Warp 8: 2.012 sec.

Warp 8 - Warp 9: 2.877 sec.

Warp 9 - Warp 9.5: 6.394 sec.

Warp 9.5 - Warp 9.75: 7.408 sec.

Warp 9.75 - Warp 9.9: 15.361 sec.

Duration (Years)

Standard: 5 Years

Maximum: 20 Years

Std. Ships Complement: 275

Officers: 35

Crew (Ensign Grade): 228

Troops: 12

Passengers: 53

Emergency condition: +369

Medical Facilities:

Doctors: 5

Nurses: 26

Operating Rooms: 4

Beds: 26

Laboratories: 8

Transporters Total: 9

1 Person: 0

2 Person: 0

6 Person: 3

12 Person: 0

22 Person: 3

Small Cargo: 2

Medium Cargo: 1

Large Cargo: 0

Super Cargo: 0

Brigs: 9

Replicators: 12

Tractor Beams: 1

Tow Capacity: 3.14×10^6 mt

Max Range: 1.12×10^4 km

Cargo Specification:

Standard Cargo Units: 211

Cargo Capacity: 10,550mt

Shuttlecraft Specifications:

Docking Ports: 2

Shuttlecraft Bays Total: 2

Small Bay: 0

Medium Bay: 2

Large Bay: 0

Super Bay: 0

Shuttlecraft Standard: 34

Work Bees: 2

Travel Pods: 1

Aquatic Shuttle: 2

Light Shuttle: 3

Standard Shuttle: 10

Survey Shuttle: 10

Heavy Shuttle: 0

Cargo Shuttle: 1

Assault Shuttle: 0

Killer Bees: 3

Fighter: 2

Lifeboats: 25

Turbolift (8 person): 15

Lifeboat (10 person): 7

Lifeboat (20 person): 3

Lifeboat (30 person): 0

Cloaking Devices: 1

Sensor Index Values:

Planetary Survey: 1.0788

Stellar Survey: 1.2599

Short Range: 1.0761

Long Range: 1.2568

Navigation: 0.8429

Special: 0.6604

Computers: 2

Type: Daystrom Duotronic III:r

Type: Daystrom Duotronic III:k

ECM Index: 1.04/2.7

Shield Rating:

Shield Index: 1.18

Holdoff Power: 2.98×10^{12} W

Refresh Rate: 8.47×10^{11} W

Breakdown Rate: 1.02×10^{12} W

Shield Dimensions (Meters)

Length: 258.00m

Width: 110.76m

Height: 135.36m

Weapons:

Phaser Power Index: 0.99

Photon Power Index: 1.54

Vessel Power Index: 1.27

Weapon Placement:

Beam (Phasers) Total: 6 banks 2 each

Output: 5.0×10^{11} W / 2.5×10^{11} W

Range: 2.5×10^5 km

Rate of Fire: 30 ppm / Cont.

Forward Banks: 1

Rear Banks: 0

Port Banks: 2

Starboard Banks: 2

Upper Banks: 0

Lower Banks: 1

Beam (MegaPhasers) Total: 0

Output: N/A

Range: N/A

Rate of Fire: N/A

Forward/Rear Banks: 0

Port/Starboard Banks: 0

Upper/Lower Banks: 0

Torpedoes (Photon) Total: 1 Bay 2 each

Stock: 30

Range: 2.0×10^5 km

Output: 10-50 Megatons

Rate of Fire: 10 ppm

Forward Bay: 1

Rear Bay: 0

Port Bay: 0

Starboard Bay: 0

Upper Bay: 0

Lower Bay: 0

FEDERATION VESSEL

SURVEY CRUISER



PLEIADES CLASS

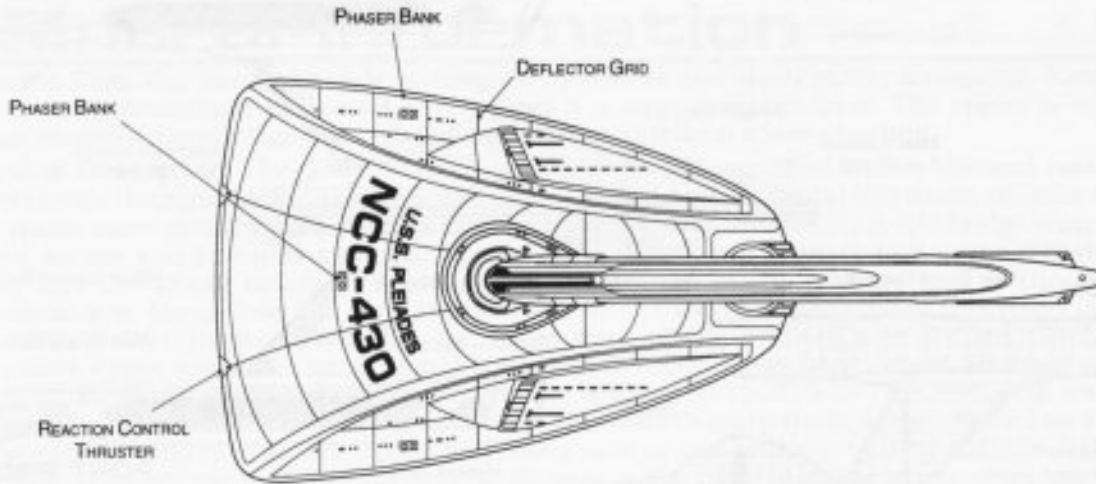

TOP PROFILE

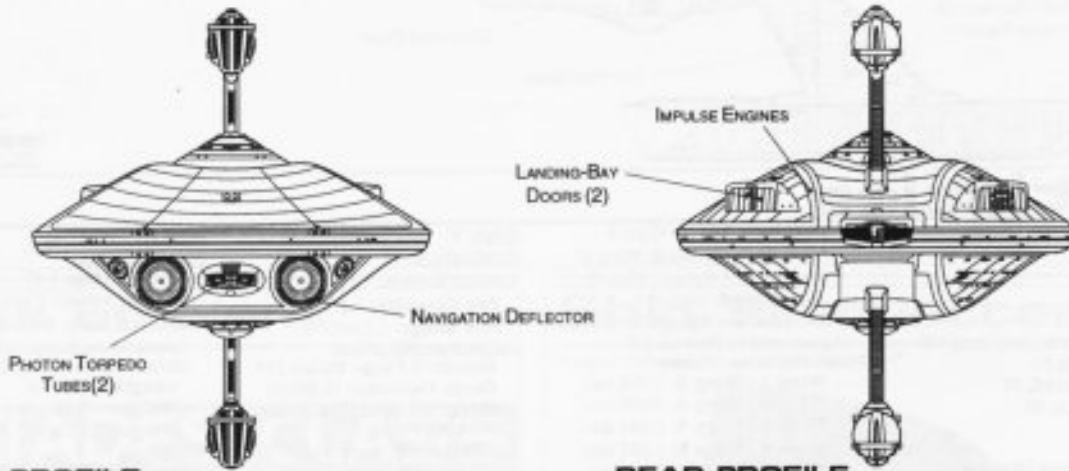

FRONT PROFILE

REAR PROFILE

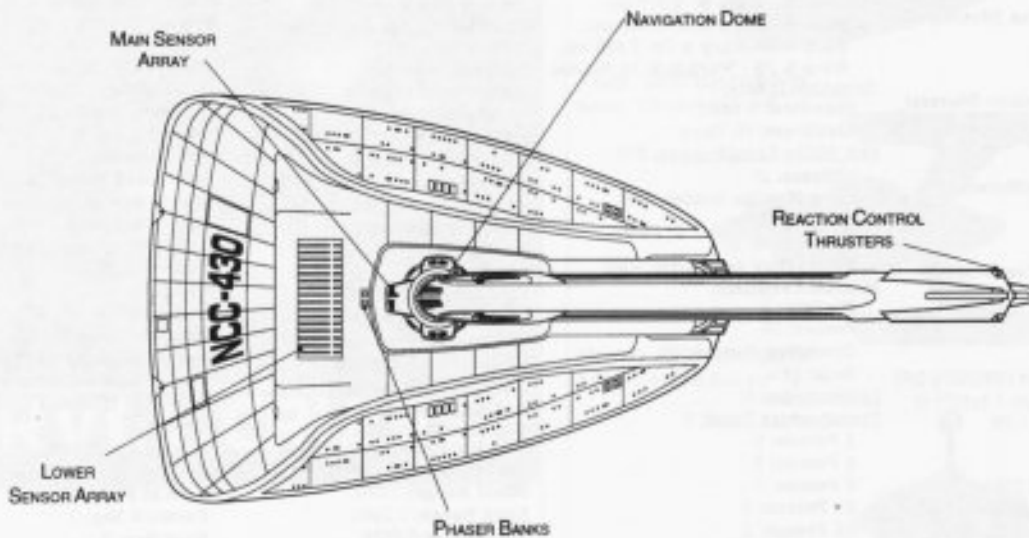

BOTTOM PROFILE

METERS
0 10 20 30 40 50
SCALE 1:2000

FEDERATION VESSEL



SURVEY CRUISER

Ship Names

THE FOLLOWING SHIPS OF THE MK-XXXIV CLASS WERE AUTHORIZED BY THE AMENDED ARTICLES OF FEDERATION OF STARDATE 2278.3

ABILITY *NCC-480***	EXPLORER *NCC-471***	SPACECLIPPER *NCC-465***
ACHIEVEMENT *NCC-486***	FOUNDATION *NCC-453	STARGAZER *NCC-473***
AMROK *NCC-483***	FREEMPORT *NCC-484***	STARPLOTTER *NCC-432
APOLLUS *NCC-431***	HASA *NCC-466***	STARRANGER *NCC-436
APOLLUS II *NCC-461***	IDUNUS *NCC-440	STARROVER *NCC-450**
ARAYUS *NCC-433	JOURNEYMAN *NCC-481***	SURVEYER *NCC-464***
ARECIBO *NCC-476***	LOOSTRA *NCC-489***	TILAKA *NCC-478***
ARGON *NCC-474***	MEDALLION *NCC-459	TRAUDNESS *NCC-482***
ASHNAR *NCC-445	MIYAT *NCC-457***	TROBRANUR *NCC-437
BALBOA *NCC-469***	OBSERVER *NCC-460	VENTURER *NCC-472***
BONDERFONN *NCC-475***	ODYSSEY *NCC-454	VIKING *NCC-456
BRAUDOS *NCC-444	ORION *NCC-451	VORTEX *NCC-442**
COBRUS *NCC-441**	PILGRIM *NCC-458	VORTEX II *NCC-462***
COMMENDATION *NCC-446	PLAIDERDUS *NCC-477***	
COMPLETION *NCC-447	PLEIADES *NCC-430*	
CONCERN *NCC-449**	PLOCYONUS *NCC-434**	
CONDERSA *NCC-465***	PROFLY *NCC-479***	
CONVENTION *NCC-483***	PROMINENCE *NCC-438	
COORDINATOR *NCC-485***	PROVIDENCE *NCC-490***	
CORDOVA *NCC-452	PULSAR *NCC-470***	
CREEETA *NCC-457	QUESTAR *NCC-435	
DALAREN *NCC-491***	REJOICE *NCC-487***	
DYNAMIC *NCC-482***	RHEESA *NCC-455	
ECLIPSE *NCC-439	RITUAL *NCC-488***	
EURANDUS *NCC-443	SEARCHER *NCC-448	

*CLASS SHIP. **LOST IN THE LINE OF DUTY. ***PROPOSED. ALL NAMES PRECEDED WITH "U.S.S."

Tractor Beam Specifications

Primary Tractor Beam Load Calculator

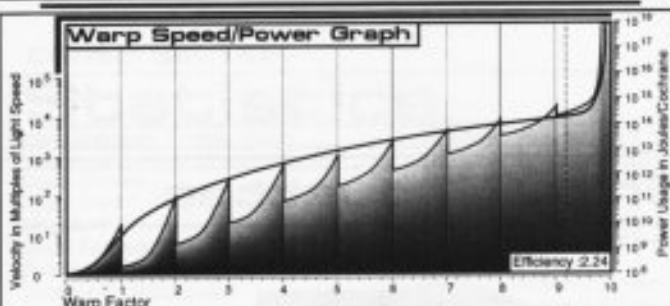
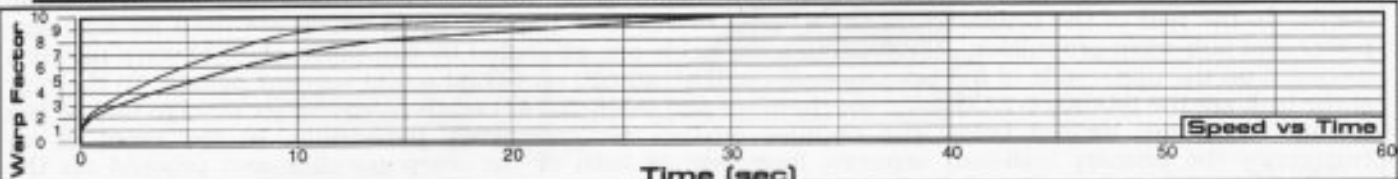
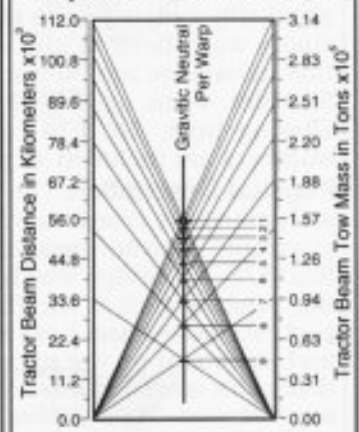

Field Length 684.80m
Field Width 175.87m
Field Height 183.00m

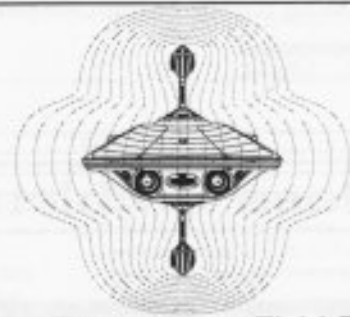

Front Warp Field Profile
Cross Section Area 19814.56 m²

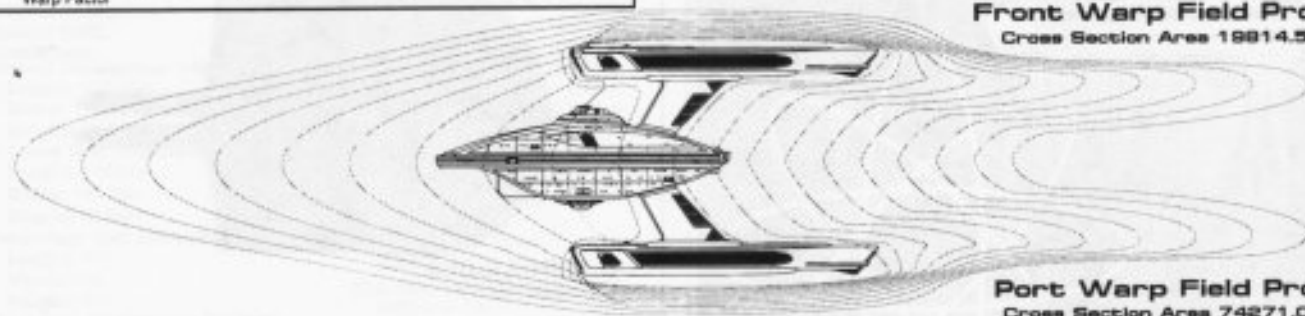

Port Warp Field Profile
Cross Section Area 74271.04 m²

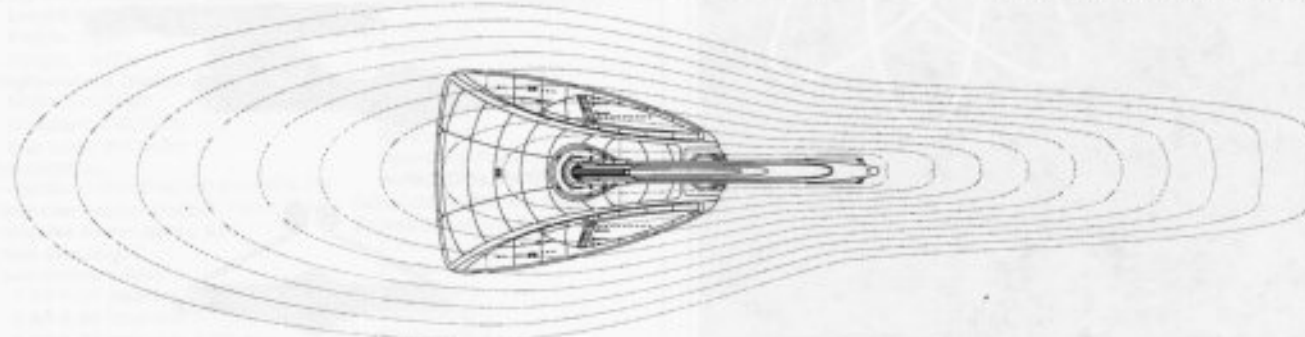

Top Warp Field Profile
Cross Section Area 80625.84 m²

WARP FIELDS

TIMESLIP CRUISER



EINSTEIN CLASS

General Information

Specific Role: The Timeslip Cruiser is a space/time exploration vessel. The cruiser is equipped with two physically isolated warp nacelles, this isolation causes a ripple (an extremely unstable warp field inside of a stable warp field) in the space/time continuum. With precise calculations the cruiser is able to regulate this imbalance and slip into another time frame. The existence of a time traveling vessel is held secret by Starfleet, while used for research, many feel that the knowledge gained does not out-weigh the dangers of altering time. To help conceal the existence of the Timeslip Cruiser, the naval construction contract numbers are included as part of the Anderson Class Heavy Scout NCC listings.

Physical Description: The Timeslip Cruiser uses an extended (PHE147/R-M1) primary hull and is equipped with extensive research systems and laboratories. Integrated into the standard deflector grid are additional electronic counter-measures to make the vessel more stealthy. The primary hull is equipped with a (BS15/R-T1) bridge which contains special space/time manipulation instrumentation. On the lower part of the primary hull is the (SM49/6J) main sensor array and (DN4/1-G) navigational dome. Located on the port, starboard and bow of the primary hull (both top and bottom) are six (BP2/30-2C) phaser banks. Port and starboard on the upper primary hull, forward of the raised extension, are the (DN2/G-4.2) navigational deflectors used to assist the navigational shields in deflecting oncoming debris. Two medium hangar decks are installed, starboard of the impulse engines, in the rear of the primary hull. Port of the impulse engines is a sensitive (CA4/RC-180W) neutrino communications array for communication with research away teams. To the rear of the primary hull are (IT186E/4-FS) dual impulse units which are used for auxiliary power and sub-warp propulsion. The vessel's warp fields are generated by two (SE52/1-5EL) warp nacelles mounted on the upper side of the primary hull by (IDU/40-6E) non-conducting support pylons. To the rear of the hull are the (MX30/4-2ZX) intermix chamber and (AM8/52-4T) matter/antimatter storage tanks. The storage tanks are located below the impulse engines for emergency jettisoning. In the event of an emergency the primary hull can separate from one or both of the warp nacelles and proceed on the remaining nacelle or impulse power.

Class Emblem

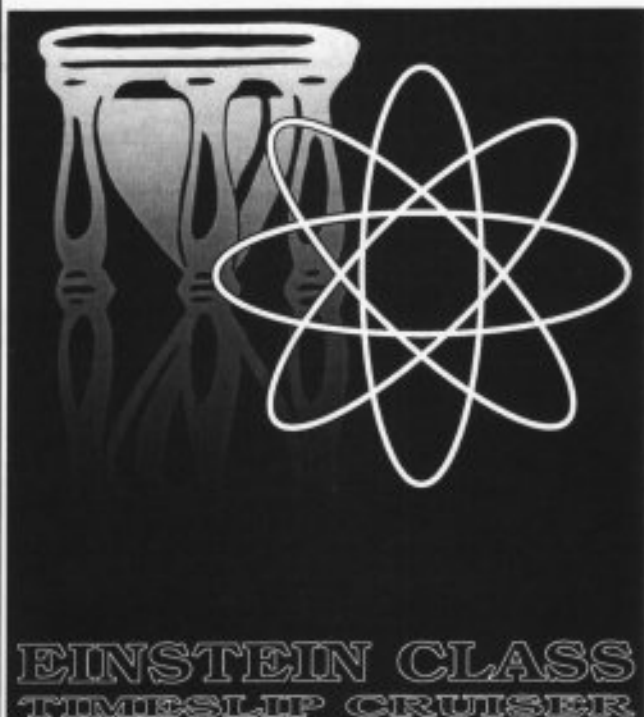

Ship Silhouettes

Total Target Area 35487.40 m²



Top Silhouette
Area 25289.72 m²



Port Silhouette
Area 8925.88 m²



Front Silhouette
Area 3271.80 m²

FEDERATION VESSEL



TIMESLIP CRUISER

EINSTEIN CLASS

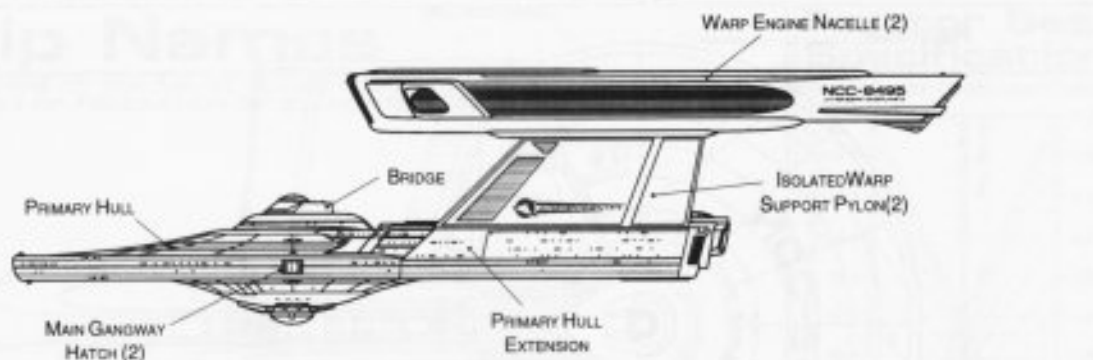

PORT PROFILE

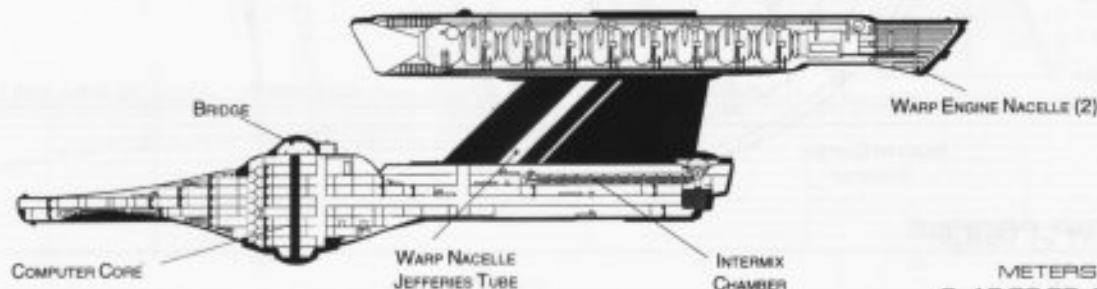

METERS
0 10 20 30 40 50
SCALE 1:2000

CROSS SECTION

Statistics

Classification: Timeslip Cruiser
Category: Research Vessel
Class: Einstein
Type: Class 2
Model: MK-VII
Naval Construction Contract: 8495
Number Proposed: 5
Number Constructed: 5
Number in Service: 4
Number Lost: 1
Dimensions:
Overall Dimensions (Meters)
 Length: 239.57m
 Width: 141.72m
 Height: 63.28m
Primary Hull Dimensions (Meters)
 Length: 146.31m
 Width: 141.72m
 Height: 32.94m
Secondary Hull Dimensions (Meters)
 Length: N/A
 Width: N/A
 Height: N/A
Warp Unit Dimensions (Meters)
 Length: 154.81m
 Width: 12.63m
 Height: 18.32m
Displacement (Metric Tons)
 Light: 196,109mt
 Standard: 210,109mt
 Full Load: 234,548mt
Performance:
Impulse Units: Dual Unit (IT186E/4-F5)
Impulse Engine Output: 7.8×10^{13} W
Impulse Power Index: 0.94
Max Cruising: C
Acceleration Rate:
 0.00-0.25 Impulse: 0.213 sec.
 0.25-0.50 Impulse: 0.319 sec.
 0.50-0.75 Impulse: 0.425 sec.
 0.75-Full Impulse: 0.532 sec.
Warp Units: 2 Nacelle Units (SE52/1-5EL)
Warp Engine Output: 1.2×10^{15} W
Warp Power Index: 0.94

Optimum Speed: Warp 4
Max. Safe Cruising: Warp 5
Emergency Speed: Warp 7
Max. Speed: Warp 9.21
Destructive Speed: Warp 9.42
Acceleration Power: 3.0
Acceleration Times:
 Warp 1 - Warp 2: 0.213 sec.
 Warp 2 - Warp 3: 0.340 sec.
 Warp 3 - Warp 4: 1.267 sec.
 Warp 4 - Warp 5: 1.851 sec.
 Warp 5 - Warp 6: 1.978 sec.
 Warp 6 - Warp 7: 2.138 sec.
 Warp 7 - Warp 8: 2.744 sec.
 Warp 8 - Warp 9: 3.925 sec.
 Warp 9 - Warp 9.5: 8.722 sec.
 Warp 9.5 - Warp 9.75: 10.104 sec.
 Warp 9.75 - Warp 9.9: 20.953 sec.
Duration (Years)
 Standard: 4 Years
 Maximum: 16 Years
Std. Ships Complement: 605
Officers: 100
Crew (Ensign Grade): 487
Troops: 18
Passengers: 53
Emergency condition: +813
Medical Facilities:
 Doctors: 6
 Nurses: 32
 Operating Rooms: 5
 Beds: 32
Laboratories: 25
Transporters Total: 17
 1 Person: 0
 2 Person: 0
 6 Person: 6
 12 Person: 0
 22 Person: 6
 Small Cargo: 3
 Medium Cargo: 2
 Large Cargo: 0
 Super Cargo: 0

Brigs: 13
Replicators: 23
Tractor Beams: 1
 Tow Capacity: 3.29×10^6 mt
 Max Range: 1.64×10^6 km
Cargo Specification:
 Standard Cargo Units: 404
 Cargo Capacity: 20,200mt
Shuttlecraft Specifications:
 Docking Ports: 1
 Shuttlecraft Bays Total: 2
 Small Bay: 0
 Medium Bay: 2
 Large Bay: 0
 Super Bay: 0
 Shuttlecraft Standard: 34
 Work Bees: 2
 Travel Pods: 1
 Aquatic Shuttle: 2
 Light Shuttle: 3
 Standard Shuttle: 10
 Survey Shuttle: 10
 Heavy Shuttle: 0
 Cargo Shuttle: 1
 Assault Shuttle: 0
 Killer Bees: 3
 Fighter: 2
 Lifeboats: 48
 Turbolift (8 person): 21
 Lifeboat (10 person): 22
 Lifeboat (20 person): 4
 Lifeboat (30 person): 1
Cloaking Devices: 1
Sensor Index Values:
 Planetary Survey: 1.1687
 Stellar Survey: 1.7228
 Short Range: 0.8818
 Long Range: 1.2998
 Navigation: 0.5587
 Special: 1.2430
Computers: 2
 Type: Daystrom Duotronic III:fx
 Type: Daystrom Duotronic III:ci

ECM Index: 1.35/3.4
Shield Rating:
 Shield Index: 0.98
 Holdoff Power: 3.39×10^{12} W
 Refresh Rate: 9.63×10^{11} W
 Breakdown Rate: 1.16×10^{12} W
Shield Dimensions (Meters)
 Length: 302.62m
 Width: 177.01m
 Height: 79.93m
WEAPONS:
Phaser Power Index: 0.627
Photon Power Index: 0.00
Vessel Power Index: 0.31
Weapon Placement:
Beam (Phasers) Total: 6 banks 2 each
 Output: 5.0×10^{11} W / 2.5×10^{11} W
 Range: 2.5×10^6 km
 Rate of Fire: 30 ppm / Cont.
 Forward Banks: 2
 Rear Banks: 0
 Port Banks: 2
 Starboard Banks: 2
 Upper Banks: 0
 Lower Banks: 0
Beam (MegaPhasers) Total: 0
 Output: N/A
 Range: N/A
 Rate of Fire: N/A
 Forward/Rear Banks: 0
 Port/Starboard Banks: 0
 Upper/Lower Banks: 0
Torpedoes (Photon) Total: N/A
 Stock: N/A
 Range: N/A
 Output: N/A
 Rate of Fire: N/A
 Forward Bay: 0
 Rear Bay: 0
 Port Bay: 0
 Starboard Bay: 0
 Upper Bay: 0
 Lower Bay: 0

FEDERATION VESSEL

TIMESLIP CRUISER



EINSTEIN CLASS

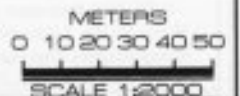
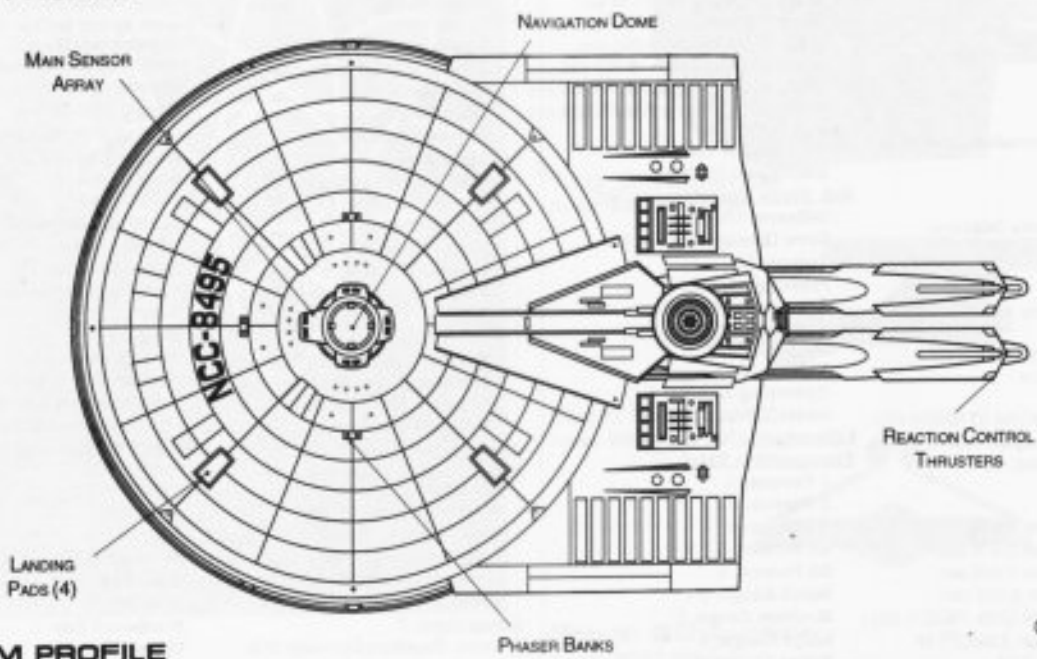
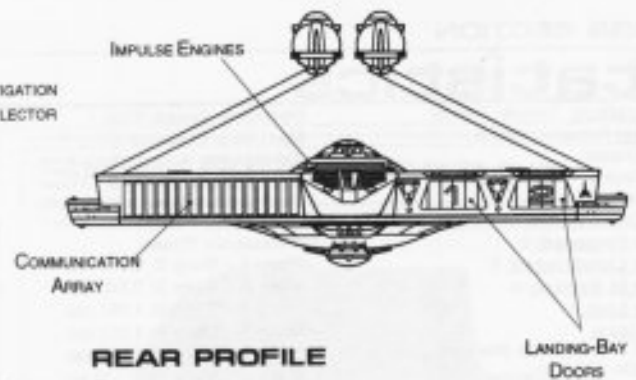
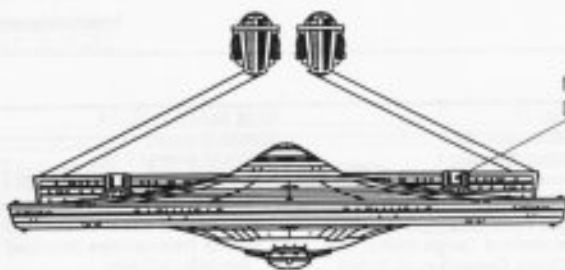
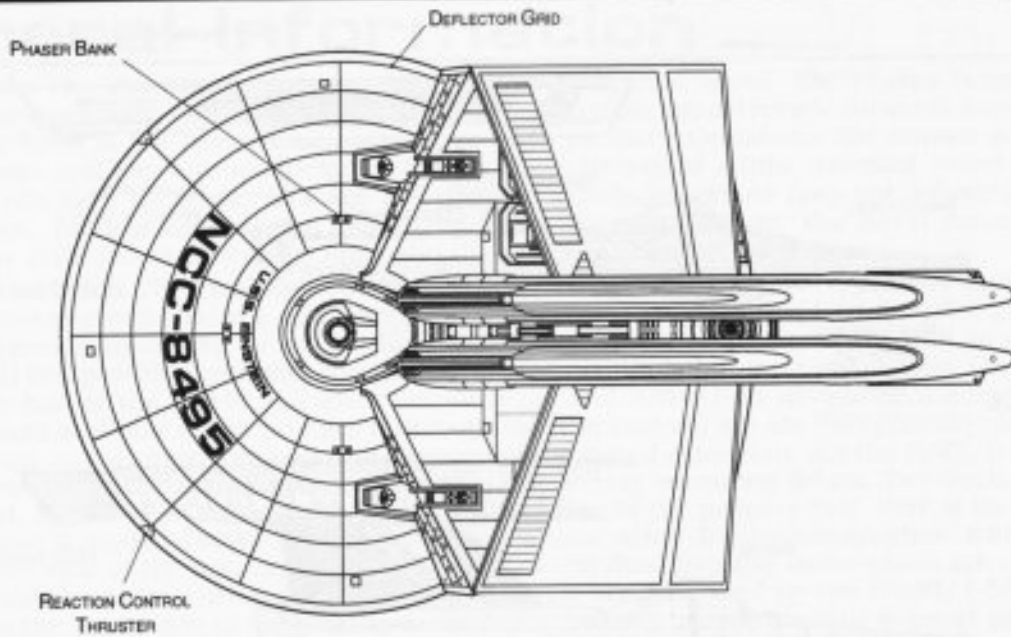

FEDERATION VESSEL



TIMESLIP CRUISER

Ship Names

THE FOLLOWING SHIPS OF THE MK-VII CLASS WERE AUTHORIZED BY THE AMENDED ARTICLES OF FEDERATION OF STARDATE 2275.2

- EINSTEIN *NCC-8495*
- GALILEO *NCC-8498
- HAWKING *NCC-8499
- LAPLACE *NCC-8496
- NEWTON *NCC-8497*

Tractor Beam Specifications

Primary Tractor Beam Load Calculator

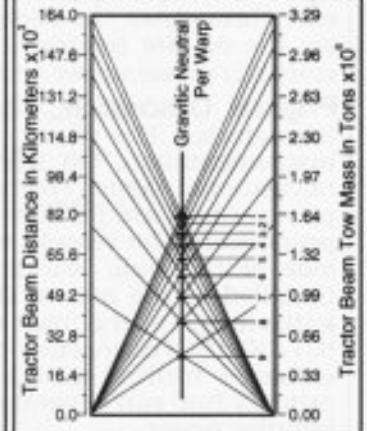

*CLASS SHIP, *LOST IN THE LINE OF DUTY, **PROPOSED, ALL NAMES PRECEDED WITH "U.S.S."

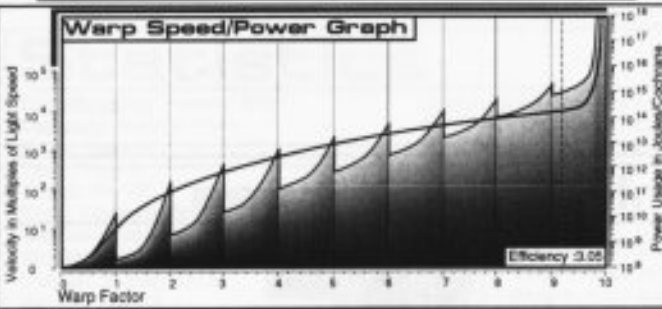
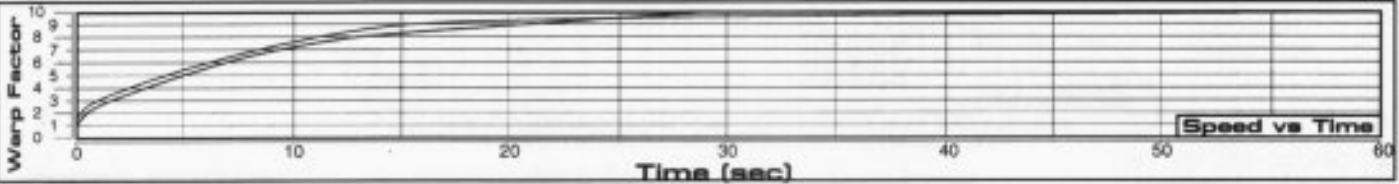

Field Length 509.11m
 Field Width 229.69m
 Field Height 100.15m

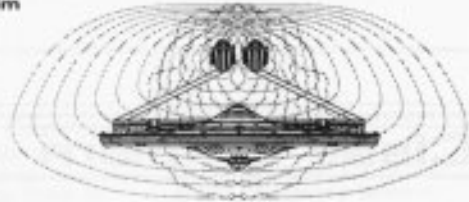

Front Warp Field Profile
 Cross Section Area 17923.84 m²

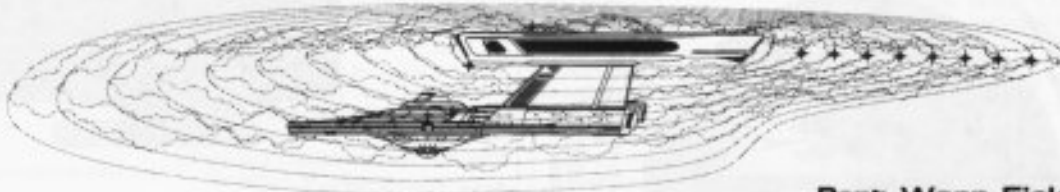

Port Warp Field Profile
 Cross Section Area 37192.04 m²

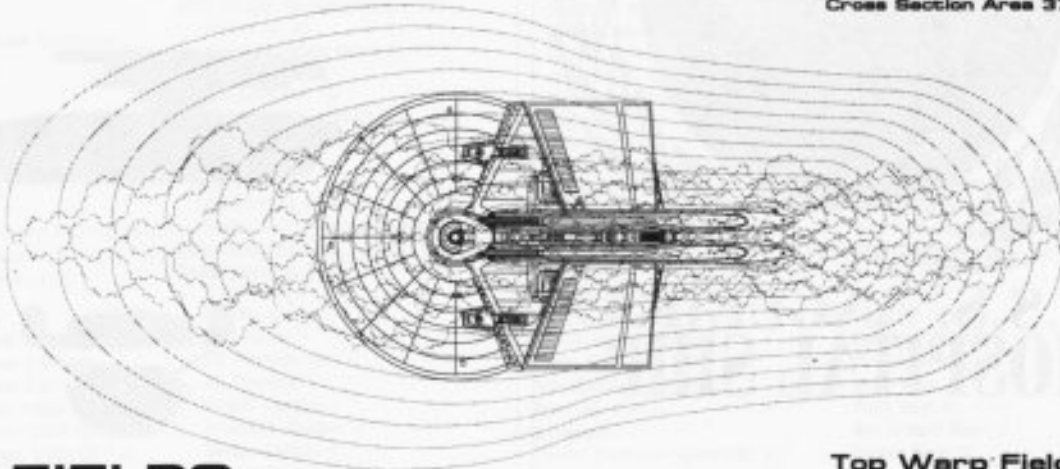

Top Warp Field Profile
 Cross Section Area 85806.18 m²

WARP FIELDS

HOSPITAL SHIP



ANGUEIRA CLASS

General Information

Specific Role: The Hospital Ship is a mobile medical facility providing support and emergency medical care throughout the Federation. The Ship is equipped with extensive laboratories and medical facilities for the on-site treatment of patients. As a cost saving measure the hull is a modified Oberth Class research vessel upper section.

Physical Description: The (SH103/M-E4) ship is equipped with additional research systems and laboratories. The vessel is equipped with a (BF5/M-L5) bridge which incorporates additional research instrumentation. On the lower part of the hull is the (SM15/5T) main sensor array and (DN2/3D) navigational dome. Positioned forward of the bridge is a (BP2/30-2C) phaser bank. At the rear of the primary hull are (ISR10E/3-ED) dual impulse units which are used for auxiliary power and sub-warp propulsion. The vessel's warp fields are generated by two (SU38/1-2AJ) warp nacelles attached to each side of the hull. Running horizontally between the nacelles is the (M20/1-2T) intermix chamber. Installed to the rear of the hull are the (AM3/15-2H) matter/antimatter storage tanks for emergency jettisoning. On the front of the hull is a small hangar deck. Slung underneath the primary hull by two (DT/30-15G) connecting dorsals is a (SH168/M-D2) secondary hull. The secondary hull is equipped with extensive medical facilities and a rear-facing medium hanger deck. In the event of an emergency, the primary hull can separate from one or both of the warp nacelles and proceed on the remaining nacelle or impulse power.

Class Emblem



**U.S.S. ANGUEIRA
HOSPITAL SHIP**

Ship Silhouettes

Total Target Area 18045.28 m²



Top Silhouette
Area 10418.08 m²



Port Silhouette
Area 5518.84 m²



FEDERATION VESSEL



HOSPITAL SHIP

ANGUEIRA CLASS

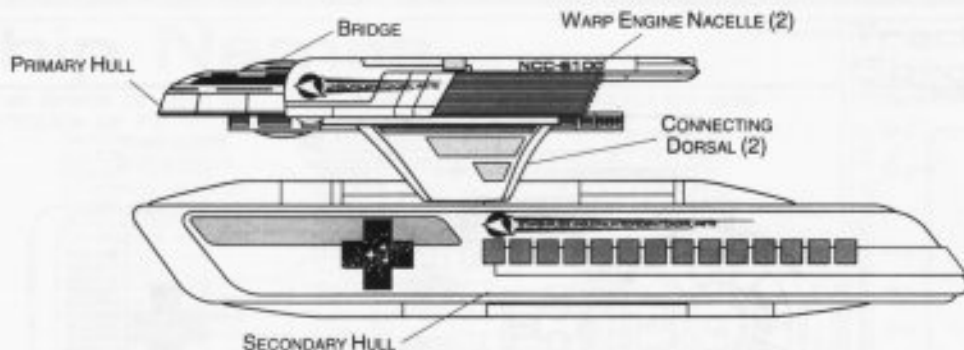

PORT PROFILE

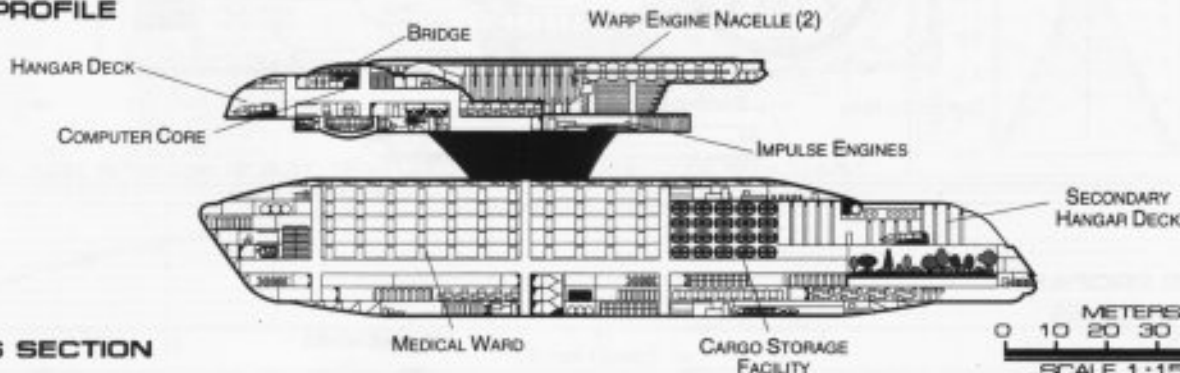

CROSS SECTION

Statistics

Classification: Hospital Ship
Category: Medical Ship
Class: Angueira
Type: Class 2
Model: MK-VIII
Naval Construction Contract: 6100
Number Proposed: 97
Number Constructed: 97
Number in Service: 91
Number Lost: 6
Dimensions:
Overall Dimensions (Meters)
 Length: 165.91m
 Width: 82.97m
 Height: 51.15m
Primary Hull Dimensions (Meters)
 Length: 92.73m
 Width: 82.97m
 Height: 15.22m
Secondary Hull Dimensions (Meters)
 Length: 165.91m
 Width: 47.63m
 Height: 28.99m
Warp Unit Dimensions (Meters)
 Length: 83.09m
 Width: 10.85m
 Height: 12.17m
Displacement (Metric Tons)
 Light: 42,775mt
 Standard: 45,829mt
 Full Load: 51,159mt
Performance:
Impulse Units: Dual Unit (ISR10E/3-ED)
Impulse Engine Output: 6.0×10^{12} W
Impulse Power Index: 4.31
Max Cruising: C
Acceleration Rate:
 0.00-0.25 Impulse: 0.186 sec.
 0.25-0.50 Impulse: 0.278 sec.
 0.50-0.75 Impulse: 0.371 sec.
 0.75-Full Impulse: 0.464 sec.
Warp Units: 2 Nacelle Units (SU38/1-2AJ)
Warp Engine Output: 1.92×10^{14} W
Warp Power Index: 0.69

Optimum Speed: Warp 4
Max. Safe Cruising: Warp 5
Emergency Speed: Warp 7
Max. Speed: Warp 8
Destructive Speed: Warp 8.58
Acceleration Power: 3.0
Acceleration Times:
 Warp 1 - Warp 2: 0.290 sec.
 Warp 2 - Warp 3: 0.464 sec.
 Warp 3 - Warp 4: 1.754 sec.
 Warp 4 - Warp 5: 2.523 sec.
 Warp 5 - Warp 6: 2.697 sec.
 Warp 6 - Warp 7: 2.914 sec.
 Warp 7 - Warp 8: 3.741 sec.
 Warp 8 - Warp 9: 5.350 sec.
 Warp 9 - Warp 9.5: 11.890 sec.
 Warp 9.5 - Warp 9.75: 13.775 sec.
 Warp 9.75 - Warp 9.9: 28.564 sec.
Duration (Years)
 Standard: 5 Years
 Maximum: 20 Years
Std. Ships Complement: 122
Officers: 20
Crew (Ensign Grade): 98
Troops: 4
Passengers: 12
Emergency condition: +200
Medical Facilities:
 Doctors: 13
 Nurses: 68
 Operating Rooms: 10
 Beds: 120
Laboratories: 2
Transporters Total: 4
 1 Person: 0
 2 Person: 0
 6 Person: 2
 12 Person: 0
 22 Person: 1
 Small Cargo: 1
 Medium Cargo: 0
 Large Cargo: 0
 Super Cargo: 0

Brigs: 3
Replicators: 3
Tractor Beams: 1
 Tow Capacity: 1.54×10^5 mt
 Max Range: 6.38×10^4 km
Cargo Specification:
 Standard Cargo Units: 93
 Cargo Capacity: 4,650mt
Shuttlecraft Specifications:
Docking Ports: 1
Shuttlecraft Bays Total: 2
 Small Bay: 1
 Medium Bay: 1
 Large Bay: 0
 Super Bay: 0
Shuttlecraft Standard: 18
 Work Bees: 1
 Travel Pods: 1
 Aquatic Shuttle: 1
 Light Shuttle: 2
 Standard Shuttle: 4
 Medical Shuttle: 8
 Heavy Shuttle: 0
 Cargo Shuttle: 1
 Assault Shuttle: 0
 Killer Bees: 0
 Fighter: 0
 Lifeboats: 15
 Turbolift (8 person): 12
 Lifeboat (10 person): 2
 Lifeboat (20 person): 1
 Lifeboat (30 person): 0
Cloaking Devices: 0
Sensor Index Values:
 Planetary Survey: 0.5042
 Stellar Survey: 0.7772
 Short Range: 0.3804
 Long Range: 0.5864
 Navigation: 0.3755
 Special: 0.3451
Computers: 2
 Type: Daystrom Duotronic II:y
 Type: Daystrom Duotronic II:h

ECM Index: 0.88
Shield Rating:
 Shield Index: 2.22
 Holdoff Power: 1.67×10^{12} W
 Refresh Rate: 4.75×10^{11} W
 Breakdown Rate: 5.70×10^{11} W
Shield Dimensions (Meters)
 Length: 199.09m
 Width: 99.56m
 Height: 61.38m
Weapons:
Phaser Power Index: 0.479
Photon Power Index: 0.00
Vessel Power Index: 0.240
Weapon Placement:
Beam (Phasers) Total: 1 banks 2 each
 Output: 5.0×10^{11} W / 2.5×10^{11} W
 Range: 2.5×10^5 km
 Rate of Fire: 30 ppm / Cont.
 Forward Banks: 1
 Rear Banks: 0
 Port Banks: 0
 Starboard Banks: 0
 Upper Banks: 0
 Lower Banks: 0
Beam (MegaPhasers) Total: 0
 Output: N/A
 Range: N/A
 Rate of Fire: N/A
 Forward/Rear Banks: 0
 Port/Starboard Banks: 0
 Upper/Lower Banks: 0
Torpedoes (Photon) Total: N/A
 Stock: N/A
 Range: N/A
 Output: N/A
 Rate of Fire: N/A
 Forward Bay: 0
 Rear Bay: 0
 Port Bay: 0
 Starboard Bay: 0
 Upper Bay: 0
 Lower Bay: 0

FEDERATION VESSEL

HOSPITAL SHIP



ANGUEIRA CLASS

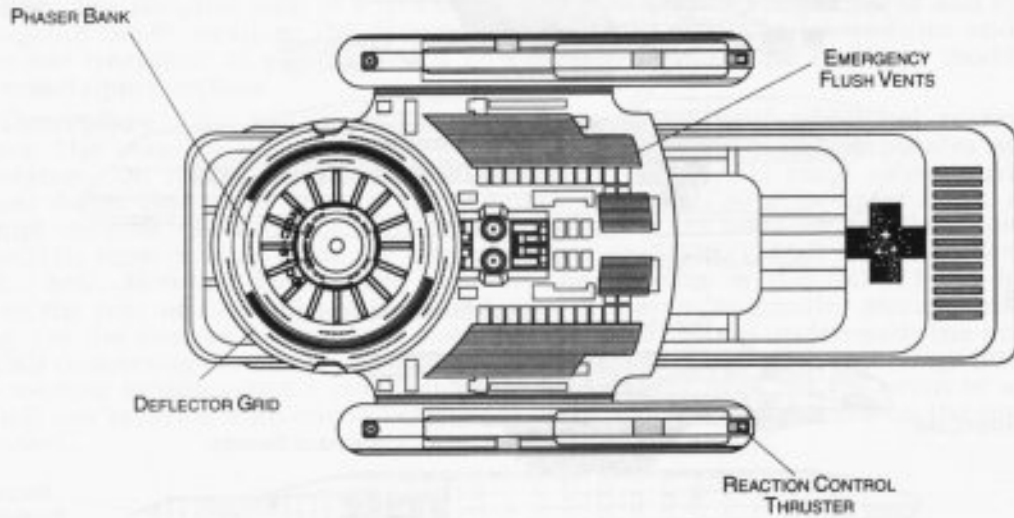

TOP PROFILE

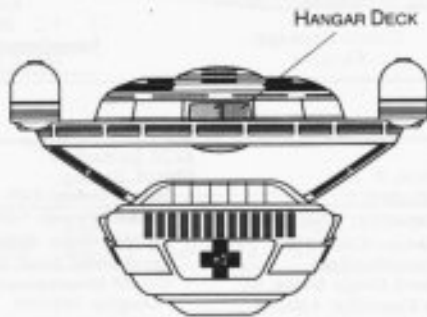

FRONT PROFILE

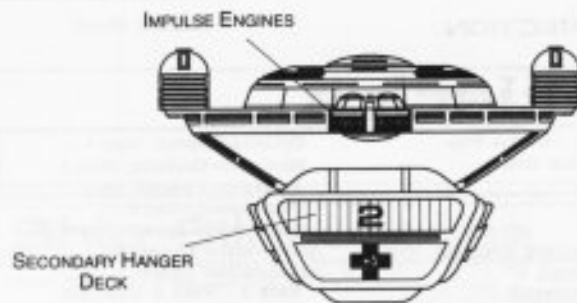

REAR PROFILE

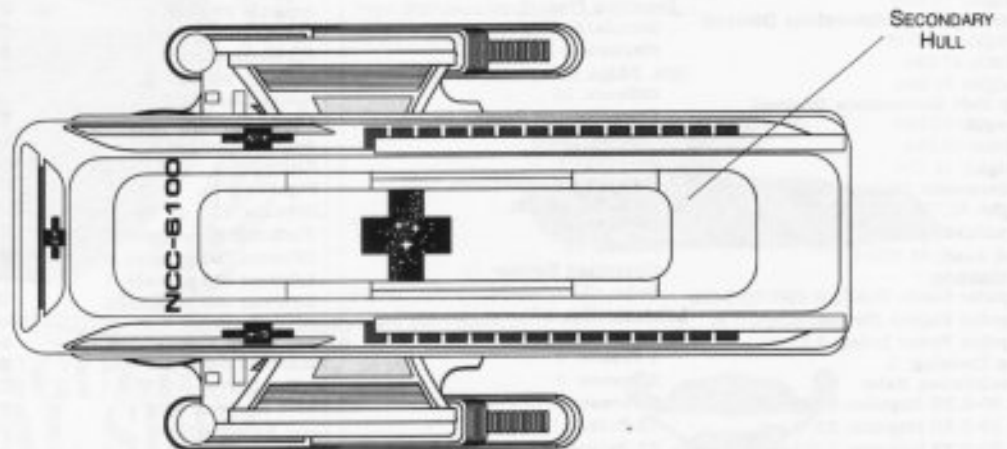

BOTTOM PROFILE



FEDERATION VESSEL



HOSPITAL SHIP

Ship Names

THE FOLLOWING SHIPS OF THE MK-VIII CLASS WERE AUTHORIZED BY THE AMENDED ARTICLES OF FEDERATION OF STARDATE 2266.3

ASERNATHY *NCC-6196
 ALDACKO *NCC-6162
 ANGUIERA *NCC-6100*
 ASHLEY *NCC-6147
 AUSTIN *NCC-6312
 AVERY *NCC-6106
 AYCOCK *NCC-6117
 BAKER *NCC-6172
 BALKO *NCC-6184
 BARTLEY *NCC-6112**
 BIRDWELL *NCC-6103
 BLAKE *NCC-6124
 BORST *NCC-6140
 BRANTE *NCC-6156
 BURCH *NCC-6179
 CABANAS *NCC-6170
 CALFIN *NCC-6150
 CARROLL *NCC-6133
 CAULEY *NCC-6101
 CLARDY *NCC-6115
 CONNER *NCC-6127
 COTTRELL *NCC-6164
 CRIBBS *NCC-6178
 CULP *NCC-6190
 CUNNINGHAM *NCC-6194

DAFFERN *NCC-6110
 DALTON *NCC-6120
 DEAVER *NCC-6130
 DICKERSON *NCC-6104
 DUGAN *NCC-6137
 DURRINGTON *NCC-6176
 DWORACZYK *NCC-6193
 DYCHE *NCC-6154
 EADE *NCC-6143
 EARSLEY *NCC-6128
 EDMONSON *NCC-6108
 EFFENFELD *NCC-6122
 ELLISSON *NCC-6102
 ELMS *NCC-6135
 ERWIN *NCC-6163
 ESTRADA *NCC-6185
 EVERETT *NCC-6195
 EZELL *NCC-6171
 FALKENBERG *NCC-6191
 FARLEY *NCC-6192
 FARLEY *NCC-6181
 FEATHERSTON *NCC-6167
 FERIS *NCC-6187
 FISK *NCC-6129
 FLINN *NCC-6111

FOGERTON *NCC-6131
 GALLIMORE *NCC-6155
 GARRETT *NCC-6160
 GIDDENS *NCC-6136
 GONZALES *NCC-6148
 GRAVES *NCC-6177
 GREGSON *NCC-6186
 GUSTAVES *NCC-6168
 HACKETT *NCC-6141**
 HAGSTROM *NCC-6116
 HANNABAS *NCC-6113
 HARKRIDER *NCC-6134
 HENEGAR *NCC-6166
 HOFFMAN *NCC-6189
 HUNZEKER *NCC-6174
 ISACCS *NCC-6165
 IVEY *NCC-6180
 JACOBS *NCC-6188**
 JAMERSON *NCC-6182
 JUAREZ *NCC-6105
 JUNG *NCC-6169**
 KAGELER *NCC-6121
 KARR *NCC-6107
 KEESSE *NCC-6144
 KENNELEY *NCC-6157**

KETRON *NCC-6175
 KIDDER *NCC-6183**
 KNARR *NCC-6161
 LAQUEY *NCC-6173
 LEACH *NCC-6142
 LOGI *NCC-6158
 MATTHEWS *NCC-6123
 McALLISTER *NCC-6109
 NAZWORTH *NCC-6139
 NEWBRO *NCC-6114
 OBIALO *NCC-6152
 PALOMO *NCC-6138
 POPNOE *NCC-6159
 REDINGER *NCC-6118
 SCOGGIN *NCC-6145
 SHAFER *NCC-6153
 TAYLOR *NCC-6146
 UTTERBACK *NCC-6126
 VERETTO *NCC-6119
 WALSTON *NCC-6151
 WEATHERBY *NCC-6125
 WETSEL *NCC-6149

*CLASS SHIP, *LOST IN THE LINE OF DUTY, **PROPOSED. ALL NAMES PRECEDED WITH "U.S.S."

Tractor Beam Specifications

Primary Tractor Beam Load Calculator

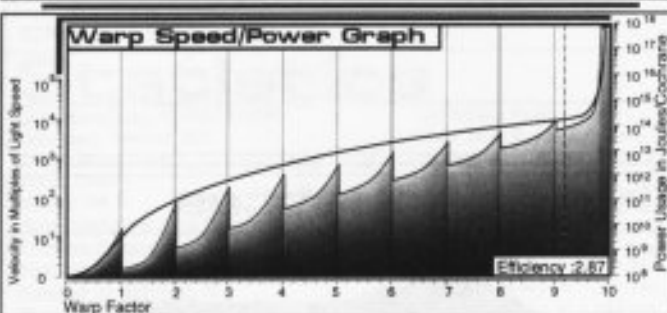
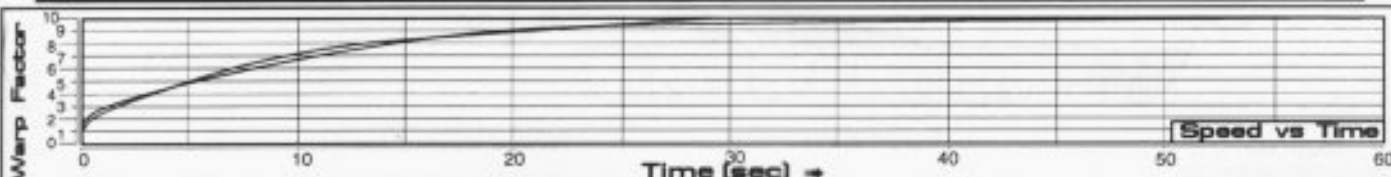
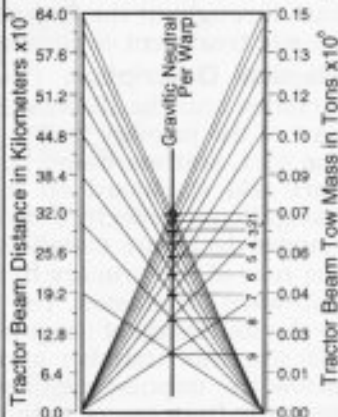

Field Length 495.37m
 Field Width 116.43m
 Field Height 79.44m

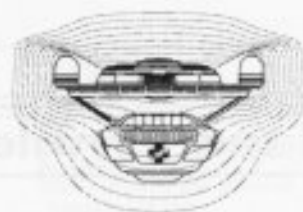

Front Warp Field Profile
 Cross Section Area 7206.00 m²

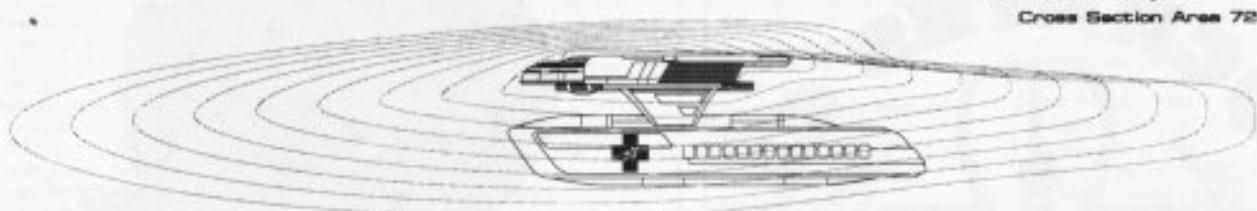

Port Warp Field Profile
 Cross Section Area 26918.78 m²

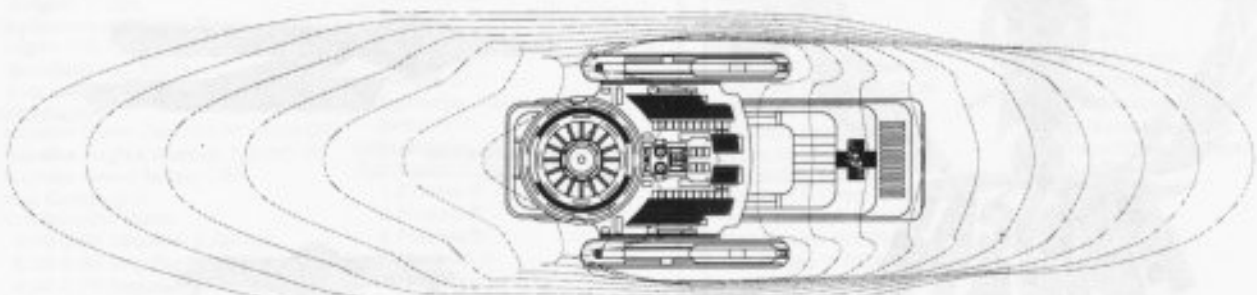

Top Warp Field Profile
 Cross Section Area 46597.20 m²

WARP FIELDS

MEDICAL FRIGATE



HIPPOCRATES CLASS

General Information

Specific Role: The Medical Frigate is a mobile medical facility providing support and emergency medical care throughout the Federation. The frigate is equipped with extensive laboratories and medical facilities for on-site treatment of patients.

Physical Description: The extended (PHE234/M-E2) primary hull is outfitted with extensive medical facilities and the (BS9/M-E6) bridge incorporates a larger tracking and surveillance station. On the lower part of the primary hull is the (SM49/3Y) main sensor array and (DN4/3-J) navigational dome. Located on the port, starboard and bow of the primary hull (both top and bottom) are six (BP2/30-2C) phaser banks. Port and starboard on the upper primary hull forward of the raised extension, are the (DN2/G-4.2) navigational deflectors used to assist the navigational shields in deflecting oncoming debris. Two medium hangar decks are installed, one on either side of the impulse engines, in the rear of the hull extension. To the rear of the primary hull are (IP186E/5-QD) dual impulse units which are used for auxiliary power and sub-warp propulsion. The frigate's warp fields are generated by two (SW52/1-5KY) warp nacelles attached to the underside of the primary hull by (DU/25-6S) support pylons. Inside the primary hull are the (M28/4-2B) intermix chamber and (AM8/36-4E) matter/antimatter storage tanks. The storage tanks are located below the impulse engines for emergency jettisoning. In the event of an emergency the primary hull can separate from one or both of the warp nacelles and proceed on the remaining nacelle or impulse power.

Class Emblem



Ship Silhouettes

Total Target Area 39234.24 m²



Top Silhouette
Area 29318.52 m²



Port Silhouette
Area 8917.00 m²



Front Silhouette
Area 2998.72 m²

FEDERATION VESSEL



MEDICAL FRIGATE

HIPPOCRATES CLASS

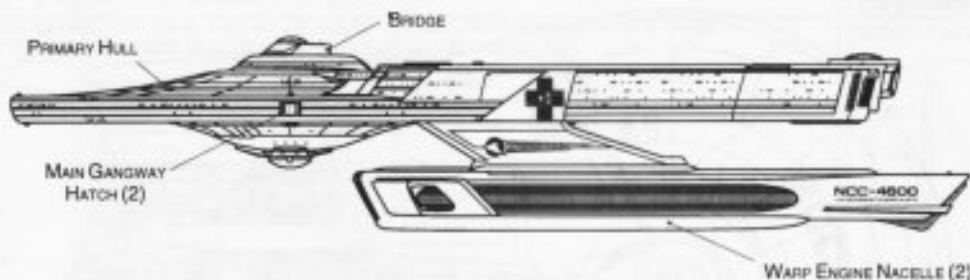

PORT PROFILE

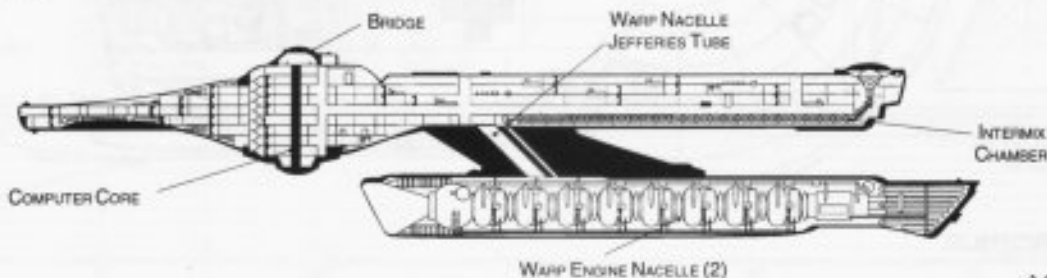

CROSS SECTION

Statistics

Classification: Medical Frigate

Category: Medical Ship

Class: Hippocrates

Type: Class 2

Model: MK-III

Naval Construction Contract: 4600

Number Proposed: 74

Number Constructed: 74

Number in Service: 72

Number Lost: 2

Dimensions:

Overall Dimensions (Meters)

Length: 241.38m

Width: 141.72m

Height: 48.53m

Primary Hull Dimensions (Meters)

Length: 222.52m

Width: 141.72m

Height: 32.94m

Secondary Hull Dimensions (Meters)

Length: N/A

Width: N/A

Height: N/A

Warp Unit Dimensions (Meters)

Length: 154.81m

Width: 12.63m

Height: 18.32m

Displacement (Metric Tons)

Light: 206,124mt

Standard: 220,838mt

Full Load: 246,526mt

Performance:

Impulse Units: Dual Unit (IP186E/5-QD)

Impulse Engine Output: 7.8x10¹³ W

Impulse Power Index: 0.89

Max Cruising: C

Acceleration Rate:

0.00-0.25 Impulse: 0.224 sec.

0.25-0.50 Impulse: 0.335 sec.

0.50-0.75 Impulse: 0.447 sec.

0.75-Full Impulse: 0.559 sec.

Warp Units: 2 Nacelle Units (SWS2/1-5KY)

Warp Engine Output: 1.2x10¹⁵ W

Warp Power Index: 0.89

Optimum Speed: Warp 4

Max. Safe Cruising: Warp 6.2

Emergency Speed: Warp 8.4

Max. Speed: Warp 9.2

Destructive Speed: Warp 9.3

Acceleration Power: 3.0

Acceleration Times:

Warp 1 - Warp 2: 0.224 sec.

Warp 2 - Warp 3: 0.358 sec.

Warp 3 - Warp 4: 1.353 sec.

Warp 4 - Warp 5: 1.945 sec.

Warp 5 - Warp 6: 2.079 sec.

Warp 6 - Warp 7: 2.247 sec.

Warp 7 - Warp 8: 2.884 sec.

Warp 8 - Warp 9: 4.125 sec.

Warp 9 - Warp 9.5: 9.167 sec.

Warp 9.5 - Warp 9.75: 10.620 sec.

Warp 9.75 - Warp 9.9: 22.023 sec.

Duration (Years)

Standard: 5 Years

Maximum: 20 Years

Std. Ships Complement: 655

Officers: 108

Crew (Ensign Grade): 527

Troops: 20

Passengers: 56

Emergency condition: +878

Medical Facilities:

Doctors: 50

Nurses: 263

Operating Rooms: 42

Beds: 1000

Laboratories: 10

Transporters Total: 21

1 Person: 0

2 Person: 0

6 Person: 9

12 Person: 0

22 Person: 9

Small Cargo: 2

Medium Cargo: 1

Large Cargo: 0

Super Cargo: 0

Brigs: 13

Replicators: 17

Tractor Beams: 1

Tow Capacity: 2.82x10⁶mt

Max Range: 7.81x10⁴km

Cargo Specification:

Standard Cargo Units: 306

Cargo Capacity: 15,300mt

Shuttlecraft Specifications:

Docking Ports: 3

Shuttlecraft Bays Total: 2

Small Bay: 0

Medium Bay: 2

Large Bay: 0

Super Bay: 0

Shuttlecraft Standard: 28

Work Bees: 2

Travel Pods: 1

Aquatic Shuttle: 1

Light Shuttle: 3

Standard Shuttle: 5

Medical Shuttle: 15

Heavy Shuttle: 0

Cargo Shuttle: 1

Assault Shuttle: 0

Killer Bees: 0

Fighter: 0

Lifeboats: 61

Turbolift (8 person): 23

Lifeboat (10 person): 26

Lifeboat (20 person): 11

Lifeboat (30 person): 1

Cloaking Devices: 0

Sensor Index Values:

Planetary Survey: 0.3804

Stellar Survey: 1.0410

Short Range: 0.2670

Long Range: 0.7854

Navigation: 0.3009

Special: 0.4764

Computers: 2

Type: Daystrom Duotronic III:b

Type: Daystrom Duotronic II:a

ECM Index: 0.94

Shield Rating:

Shield Index: 0.48

Holdoff Power: 1.74x10¹² W

Refresh Rate: 4.94x10¹¹ W

Breakdown Rate: 5.92x10¹¹ W

Shield Dimensions (Meters)

Length: 304.91m

Width: 177.01m

Height: 61.31m

Weapons:

Phaser Power Index: 0.59

Photon Power Index: 0.00

Vessel Power Index: 0.30

Weapon Placement:

Beam (Phasers) Total: 6 banks 2 each

Output: 5.0x10¹¹ W / 2.5x10¹¹ W

Range: 2.5x 10⁵ km

Rate of Fire: 30 ppm / Cont.

Forward Banks: 2

Rear Banks: 0

Port Banks: 2

Starboard Banks: 2

Upper Banks: 0

Lower Banks: 0

Beam (MegaPhasers) Total: 0

Output: N/A

Range: N/A

Rate of Fire: N/A

Forward/Rear Banks: 0

Port/Starboard Banks: 0

Upper/Lower Banks: 0

Torpedoes (Photon) Total: N/A

Stock: N/A

Range: N/A

Output: N/A

Rate of Fire: N/A

Forward Bay: 0

Rear Bay: 0

Port Bay: 0

Starboard Bay: 0

Upper Bay: 0

Lower Bay: 0

FEDERATION VESSEL

MEDICAL FRIGATE



HIPPOCRATES CLASS

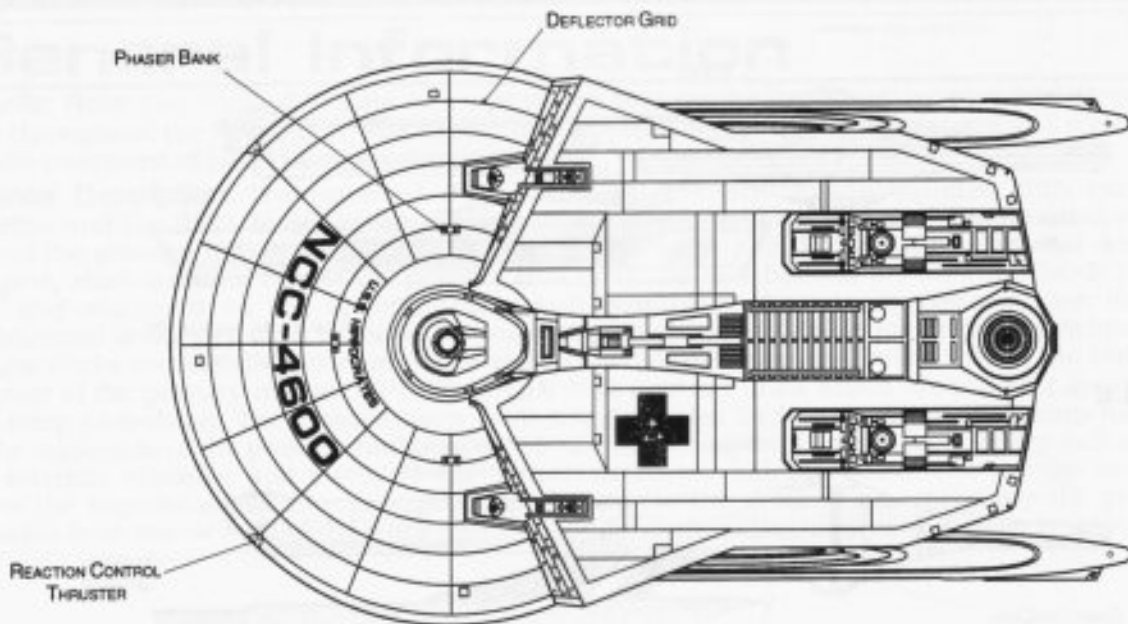

TOP PROFILE

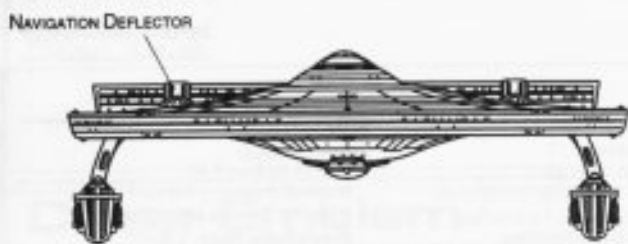

FRONT PROFILE

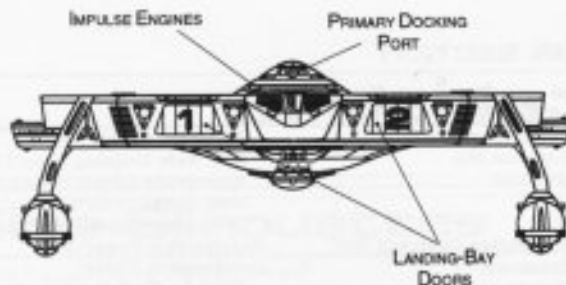

REAR PROFILE

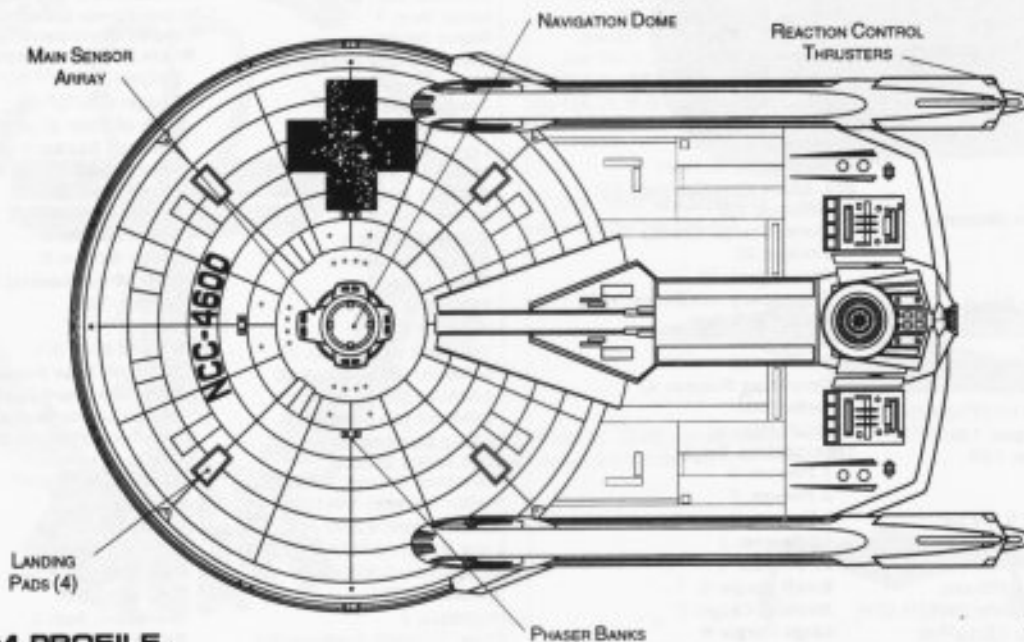

BOTTOM PROFILE



FEDERATION VESSEL



MEDICAL FRIGATE

Ship Names

THE FOLLOWING SHIPS OF THE MK-III CLASS WERE AUTHORIZED BY THE AMENDED ARTICLES OF FEDERATION OF STARDATE 2268.4

ABBOTT *NCC-4673	GARTH *NCC-4618	MABBIT *NCC-4609
ACOSTA *NCC-4682	GORDON *NCC-4601	MEADOWS *NCC-4602
ASHBROOK *NCC-4646	GRACIE *NCC-4627	MENTOR *NCC-4624
ATKINSON *NCC-4633	HAMERSLEY *NCC-4610	NIELSON *NCC-4644
BAGWELL *NCC-4614	HELMBRECHT *NCC-4623	NIPPER *NCC-4657
BAIN *NCC-4620	HERNDON *NCC-4645	OLIVER *NCC-4655
BARNETT *NCC-4604	HINKLEY *NCC-4668	PABAST *NCC-4658
BEADLESS *NCC-4608	HIPPOCRATES *NCC-4600*	PICTUM *NCC-4648
BIRDSALL *NCC-4640	HOEFLER *NCC-4670	QUINCY *NCC-4660
BLACKWOOD *NCC-4650	IDALOU *NCC-4628	RICHMOND *NCC-4613
CABALLERO *NCC-4655	ISLER *NCC-4607	ROOMAN *NCC-4631
CAMPSEY *NCC-4643	JACINTO *NCC-4603	SCHULTZ *NCC-4611
CASTLEBERRY *NCC-4663	JOSEPHSON *NCC-4661	SEARLS *NCC-4619*
CLAMPITT *NCC-4669	JULIAN *NCC-4666	SLAUGHTER *NCC-4638
DARSEY *NCC-4625	KAMALPOOR *NCC-4605	TILGER *NCC-4652
DAVILLA *NCC-4649	KEELING *NCC-4616	TRIMBLE *NCC-4647
DOWDY *NCC-4672	KILDARE *NCC-4642	URRIVE *NCC-4651*
DUVAK *NCC-4656	KIRBY *NCC-4639	VARELA *NCC-4626
ECKHOFF *NCC-4606	KURTH *NCC-4653	VOIGT *NCC-4634
ELDEREDGE *NCC-4612	LABOMBARD *NCC-4667	WALTERS *NCC-4619
ETTER *NCC-4629	LAMBERTH *NCC-4659	WARNOCK *NCC-4632
FAIRBANKS *NCC-4637	LAWSON *NCC-4641	WEXLER *NCC-4622
FAULKENBERRY *NCC-4617	LONGORIA *NCC-4654	YODER *NCC-4630
FOERSTER *NCC-4671	LORAN *NCC-4664	ZARATE *NCC-4621
GABRIEL *NCC-4635	LYNSKEY *NCC-4636	

*CLASS SHIP, **LOST IN THE LINE OF DUTY, ***PROPOSED. ALL NAMES PRECEDED WITH "U.S.S."

Tractor Beam Specifications

Primary Tractor Beam Load Calculator

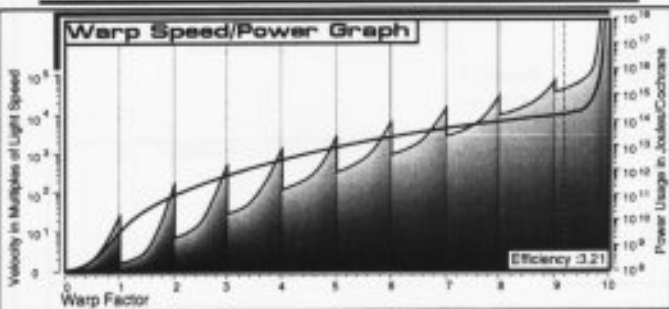
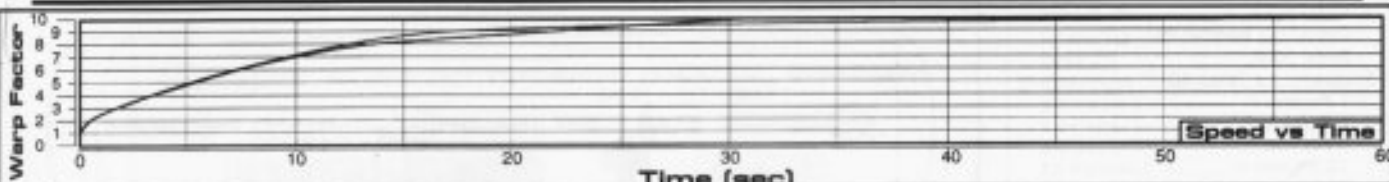
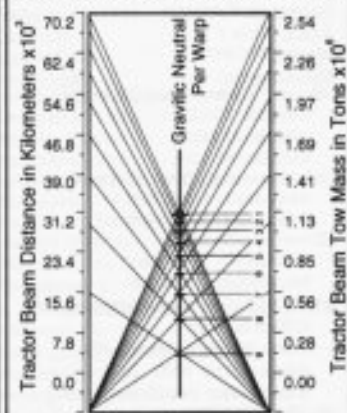

Field Length 521.82m
Field Width 230.74m
Field Height 102.71m

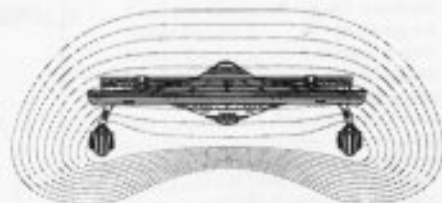

Front Warp Field Profile
Cross Section Area 18944.96 m²

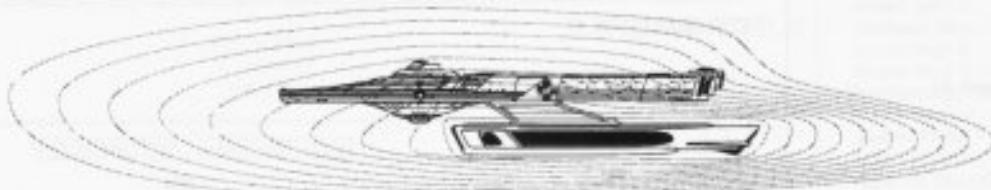

Port Warp Field Profile
Cross Section Area 39205.96 m²

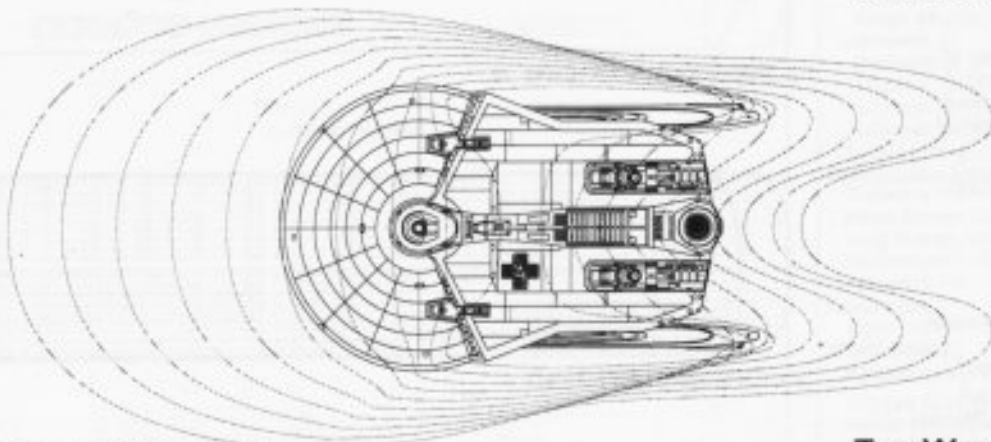

Top Warp Field Profile
Cross Section Area 90273.04 m²

WARP FIELDS

SRM2 04:06:02:04

STARFLEET REFERENCE MANUAL

HIPPOCRATES CLASS

FEDERATION VESSEL

MEDICAL CONTAINER



Statistics

Classification: Medical Container

Category: Container

Type: Class 7

Model: MK-XIII

Dimensions:

Overall Dimensions (Meters)

Length: 235.05m

Width: 48.00m

Height: 48.00m

Displacement (Metric Tons)

Standard: 115,938mt

Full Load: 342,814mt

Duration (Years)

Standard: 15 Years

Maximum: 20 Years

Std. Container Complement: 550

Officers: 100

Crew (Ensign Grade): 450

Passengers: 1000

Emergency condition: +1000

Medical Facilities:

Doctors: 100

Nurses: 500

Operating Rooms: 80

Beds: 3000

Transporters Total: 16

1 Person: 0

2 Person: 0

6 Person: 8

12 Person: 0

22 Person: 4

Small Cargo: 4

Medium Cargo: 0

Large Cargo: 0

Super Cargo: 0

Mega Cargo: 0

TraCTOR Beams: 0

Tow Capacity: N/A

Max. Range: N/A

Cargo Specification:

Standard Cargo Units: 187

Cargo Capacity: 9,350mt

Deck Height: 2.4m

Shuttlecraft Specifications:

Shuttlecraft Bays Total: 12

Small Bay: 12

Medium Bay: 0

Large Bay: 0

Super Bay: 0

Shuttlecraft Standard: 15

Work Bees: 0

Travel Pods: 0

Light Shuttle: 8

Aquatic Shuttle: 0

Shuttle Standard: 5

Heavy Shuttle: 0

Medical Shuttle: 10

Heavy Fighter: 0

Lifeboats: 35

Turbolift (8 person): 15

Lifeboat (10 person): 0

Lifeboat (20 person): 0

Lifeboat (30 person): 20

Docking Rings: 2

Sensor Input Values:

Planetary Survey: 0.020

Short Range: 0.020

Long Range: 0.020

Navigation: 0.020

Special: 0.020

Computers: 1

Type: Daystrom Duotronic IIX

Shield Rating:

Holdoff Power: 3.24×10^8

Refresh Rate: 9.21×10^7

Shield Dimensions (Meters)

Length: 282.01m

Width: 57.6m

Height: 57.6m

General Information

The Medical Container is an independent mobile medical facility providing support and emergency medical care throughout the Federation. The container is also equipped with a twelve-bay hangar deck used for patient transfer.

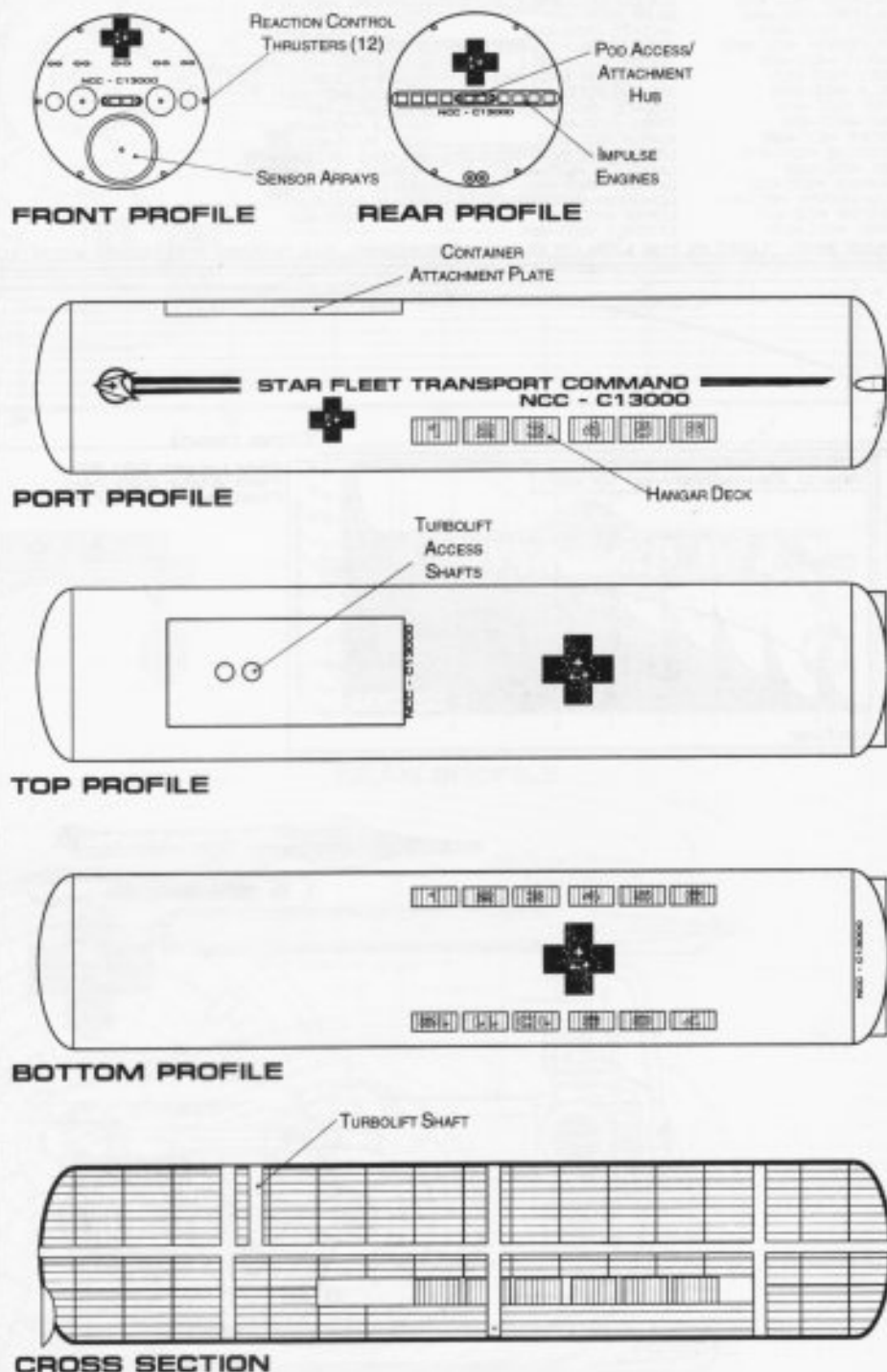

METERS
0 10 20 30 40 50
SCALE 1:2000

STATION CONTAINER

General Information

The Station Container is a hub for the attachment of various containers. The container is equipped with extensive support equipment and auxiliary power. The container is also equipped with a six-bay hangar deck used for auxiliary hangar space.

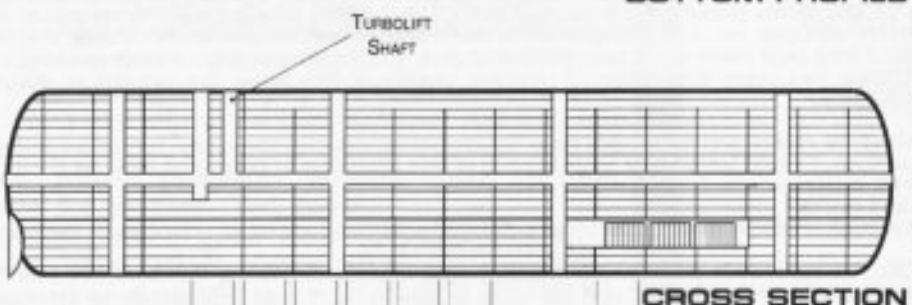
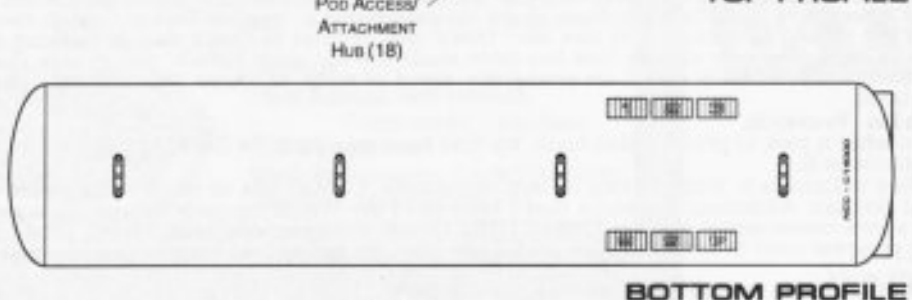
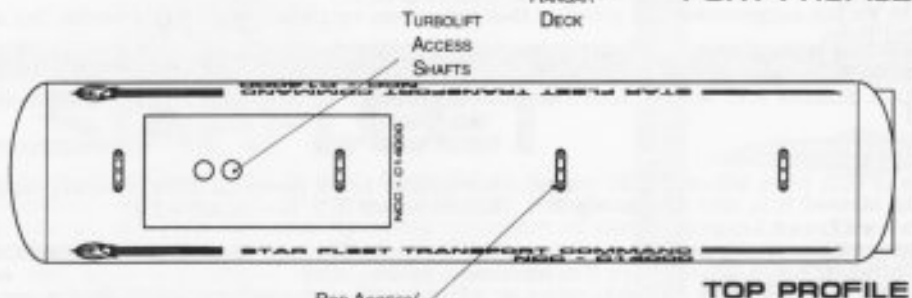
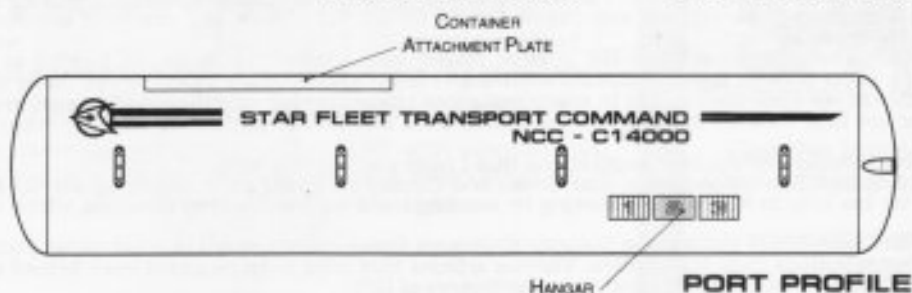
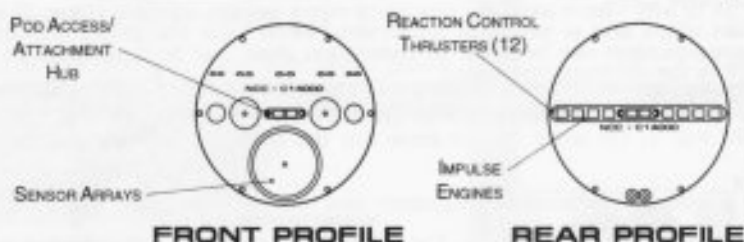

METERS
0 10 20 30 40 50
SCALE 1:2000



Statistics

Classification: Station Container
Category: Container
Type: Class 7
Model: MK-XIV
Dimensions:
Overall Dimensions (Meters)
Length: 235.05m
Width: 48.00m
Height: 48.00m
Displacement (Metric Tons)
Standard: 116,914mt
Full Load: 348,742mt
Duration (Years)
Standard: 15 Years
Maximum: 20 Years
Std. Container Complement: 156
Officers: 26
Crew (Ensign Grade): 130
Passengers: 200
Emergency condition: +200
Medical Facilities:
Doctors: 4
Nurses: 20
Operating Rooms: 3
Beds: 20
Transporters Total: 24
1 Person: 0
2 Person: 0
6 Person: 8
12 Person: 0
22 Person: 8
Small Cargo: 4
Medium Cargo: 4
Large Cargo: 0
Super Cargo: 0
Mega Cargo: 0
Tractor Beams: 1
Tow Capacity: 4.57×10^6 mt
Max Range: 1.03×10^8 km
Cargo Specification:
Standard Cargo Units: 187
Cargo Capacity: 9,350mt
Deck Height: 2.4m
Shuttlecraft Specifications:
Shuttlecraft Bays Total: 6
Small Bay: 6
Medium Bay: 0
Large Bay: 0
Super Bay: 0
Shuttlecraft Standard: 31
Work Bees: 4
Travel Pods: 4
Light Shuttle: 4
Aquatic Shuttle: 2
Shuttle Standard: 8
Heavy Shuttle: 3
Medical Shuttle: 2
Cargo Shuttle: 4
Lifeboats: 50
Turbolift (8 person): 20
Lifeboat (10 person): 5
Lifeboat (20 person): 5
Lifeboat (30 person): 20
Docking Rings: 2
Sensor Input Values:
Planetary Survey: 0.020
Short Range: 0.020
Long Range: 0.020
Navigation: 0.020
Special: 0.020
Computers: 1
Type: Daystrom Duotronic IIX
Shield Rating:
Holdoff Power: 3.24×10^8
Refresh Rate: 9.21×10^7
Shield Dimensions (Meters)
Length: 282.01m
Width: 57.6m
Height: 57.6m

DELIVERANCE CLASS

FEDERATION CONTAINER

CLOSING



Closing Information

Closing

First off I would like to express my thanks to you for purchasing this book. I have tried to give the most information that I can for each ship without reducing the number of ships described. This in turn has lead to small print. I hope that this is not an inconvenience to anyone and if it is, I would like to express my deepest apology.

Stardate Errata

In place of the stardates, I have used the actual YEAR.MONTH due to the fact that I can not get an accurate stardate, as every group has a stardate system that while close do not all match (Some systems differ by as much as 50 years). To achieve the stardate you need just use the date given and apply it to the stardate system you are acquainted with.

Warspeed Errata

I have had a number of people inquire as to why I have used the new warp curve system on older ships. The thing to understand here is that this curve also fits the older ships and is simply a conversion; when I get around to drawing the new ships the statistics will match and a ship to ship comparison can be made. A conversion chart has been included at the beginning of the ship section so that you can convert back to the old warp numbers.

Dimension Corrections

Due to a corrupted computer program many of the dimensions in my second book were off by 4.3% to 5.7%. This has been fixed in this book and in the reprints of SRM Vol. 1. I'm sorry for the error but the book was already printed before the error was noticed.

Acknowledgements

I would like to acknowledge the many people, places, movies, magazines and reference materials that I have use to get the most accurate information for my work.

I would like to thank the following magazines: Starlog, Future, Fantastic Films, Challenge, Stardate, Cinefex, Science Fiction Modeling, Fine Scale Modeler, Galactic Engineers Concordance and Digest Group for all the photos and excellent articles and insight that these magazines have given me in my research.

I would also like to thank all the people who were involved in the original stories and artwork creations. By looking at their models, photos, sketches and story lines I was able to draw additional craft that I hope still retained much of the flavor of the original story. I am sorry that I am not able to list their names, but in many instances I have no idea who these individuals are.

Special thanks to my wife RoseAnna for her help with the naming of ships in this book and for her putting up with my crazy work hours to finish it, thanks honey again.

And special thanks to Joshua and Michael Babunovic for their suggestions that I have used in this book.

Thanks going to Sid Deavours and his side-kick Steve Woodard at Star Books and Comics for giving me a supply for my Sci-Fi flux.

I would like to thank Alex Rosenzweig for his help in the NCC numbering by sending me a copy of his ship database which saved me a large amount of time.

I would also like to make note of Roy Firestone for his publication Galactic Engineers Concordance which is a non profit Techzine that he publishes which is made up of contributions from his readers. Various articles that have been included have helped in my train of thought for creating my starship designs. Thanks to Roy and the contributors of GEC.

I would like to thank Paul Hollingsworth for his suggestions and proofing that helped me catch two very stupid errors that might have slipped through if he had not spotted them.

Special thanks go out to Chris Hatfield, and Bill Howe for spending nights and nights and nights helping to flesh out the text (going blind as Chris puts it) giving the ships more life.

I would like to give special thanks Don Shanks and Magne Kristiansen for their proof reading and editing of my text and drawings.

And finally, Tiny I'm still not worthy.

Jackill's Engineers

Chris Hatfield (C1), Dr. Eugenio Angueta III (E3), Mark Wilson (E2:3), Shane Johnson (E2), Roger Sørensen (E1:2), Michael Alexander (E1), Scott Bell (E1+), Don Corson (E1), Cliff Maxwell (E1), Alex Rosenzweig (E1), Thomas Sasser (E1), Don Shanks (E1).

Thanks for the contributions

I would like to thank Dr. Eugenio Angueta III for the drawings he sent me that led to the Through Deck Cruiser, Escort Cruiser and Timeslip Cruiser and for suggestions that he made to help make this book more professional.

I would also like to thank Cliff Maxwell for the drawings he sent that with just a few modifications became the Strike Cruiser.

And finally I would like to thank Don Corson, who I had to track down to get his permission to use his Survey Cruiser that has appeared in various publications and I felt should be included in this one. Don's only request is that I change nothing of his original design. If I have, this was done in error. The only change that has been made are the warp speeds, please note that the creator feels that the cruiser has a cruising speed of warp 8 and an emergency speed of warp 12, these were the only changes made to have the ship fit the rest of the book.

What it took for this book

I want to include a little information on what it took to produce this book. My first book was Jackill's Guide to Light Attack Craft (Volume 1) which was produced using MacDraw II.

For my second and third book I switched to Canvas 3. While having its own drawbacks, Canvas has so much more power that I am able to produce a more professional product. Additional programs that I have used are WingZ (spreadsheet program used to calculate the ship statistics and warp speed conversions); Cricket Graph, Delta Graph Pro (graphing programs to produce the graphs); MacWrite Pro (word processing program used to write the text); and a few other programs that have helped in small ways but are too numerous to list.

This book took up over 46.5 Meg (my first book was around 6 Meg and my second around 32 Meg) with each individual file taking up over 1 Meg each. The book contains 27,993 words (which works out to 134,373 characters, just in case you wanted to know) and 252,533 drawing elements (lines, circles, squares, etc.). The largest file is the WorkBee section that is over 8 meg, the second is the Communication Station that is over 3 meg (and made up of over 9000 triangles, *what a pain to draw*, which was required to produce the most accurate drawing). I hope you enjoy the improved printing quality of this book, it's printed at 600dpi as compared to the last that was printed at 300dpi.

Gripe

To anyone out their who is stupid enough to create and knowingly pass on computer viruses, you came very close to hurting yourself. If I wasn't an avid believer in backups, I could have lost a large section of this book due to corrupted files. So if you think viruses can only hurt other people, *think again*.

Warnings & Disclaimers

HANDLE WITH EXTREME CARE: This book contains minute electrically charged particles moving at velocities in excess of five hundred million miles per hour**

COMPONENT EQUIVALENCY NOTICE: The subatomic particles (electrons, protons, etc.) comprising this book are exactly the same in every measurable respect as those used in other books, and no claim to the contrary may legitimately be expressed or implied**

IMPORTANT NOTICE: The entire physical universe, including this book, may one day collapse back into a infinitesimally small space. Should another universe subsequently re-emerge, the existence of this book in that universe cannot be guaranteed**

NOTE: Any reference to any lifeform living, dead or hallucinatory is purely coincidental.*

Jackill's
STAR FLEET REFERENCE MANUAL
Ships of the Fleet
Volume II



2