

FIRST REVISED EDITION  
PRIME ONE TIMELINE  
[MODIFIED GRAHAM/MANDEL]

9



# FEDERATION SPACEFLIGHT CHRONOLOGY

TERRAN ORIENTATION

TERRANOLO LANGUAGE EDITION



**AUTHORIZED  
PERSONNEL ONLY**  
SECURITY LEVEL TWO

---

Original texts and manuscript concept copyright © 2007 by Richard E. Mandel

*STAR TREK*, its on-screen derivatives, and all associated materials are the property of Paramount Pictures Corporation. Multiple references in this document are given under the terms of fair use with regard to international copyright and trademark law. This is a scholarly reference work intended to explain the background and historical aspects of *STAR TREK* and its spacecraft technology and is not sponsored, approved, or authorized by Paramount Pictures and its affiliated licensees.

All visual materials included herein is protected by either implied or statutory copyright and are reproduced either with the permission of the copyright holder or under the terms of fair use as defined under current international copyright law.

All visual materials used in this work without clearance were obtained from public sources through public means and were believed to be in the public domain or available for inclusion via the fair use doctrine at the time of printing.

Cover art by SciFi Meshes and Starship Modeler

This work is dedicated to Geoffery Mandel, who started it for all of us.

Memory Alpha and SFHQ/Mastercom cataloging data:  
UFP/SFD DTA HR:217622

# PART NINE

## 2190-2220: A NEW DIRECTION

### OVERVIEW

### CHRONOLOGY/TIMELINE

### STAR FLEET STARSHIPS:

**MANIN** CLASS CRUISER

**RICKENBACKER** CLASS TRANSPORT

**U.S.S. SIGMA** PROTOTYPE BATTLECRUISER

**ILLUSTRIOUS** CLASS SHUTTLECARRIER

**LOWELL** CLASS SCOUT

**CR594** MOBILE CONSTRUCTION RIG

**BERING** CLASS AUTOMATED TANKER

**BATON ROUGE** CLASS HEAVY CRUISER

**RANGER** CLASS SURVEY CRUISER

**CONSTANT WARWICK** CLASS LIGHT CRUISER

**HALE** CLASS SCOUT

**COVENTRY** CLASS CRUISER

**BODE** CLASS SCOUT

**DETROYAT** CLASS HEAVY DESTROYER

**NORDENSKJOLD** CLASS CRUISER

**DRAKE** CLASS DESTROYER AND **COOK**

CLASS SCOUT

**INVINCIBLE** CLASS DREADNOUGHT

### CIVILIAN STARSHIPS:

**PROVIDER** CLASS TUG

**HUNTER** CLASS CORVETTE

**MASTERS** CLASS TUG

**HERCULES** CLASS TRANSPORT

**CABOT** CLASS TRAWLER

### TERRAN EXPLORATIONS:

**HYDRA II**

### HISTORICAL ARTICLES:

**NEW STARSHIP EXCEEDS WARP 4**

**BACK-TO-EARTH MOVEMENT PROCLAIMED**

**BIRTH OF THE SUPERCONVOY**

**LARGEST SPACELIFT IN HISTORY**

**DEATH OF A LEGEND**

**BATON ROUGE MARKS NEW STARSHIP ERA**

**FIRST MATERIALIZER TEST SUCCESSFUL**

**A NEW TYPE OF TORPEDO**

**THE CLASS I PROGRAM**

### ACKNOWLEDGEMENTS



*U.S.S. Endurance (NCC-451)*

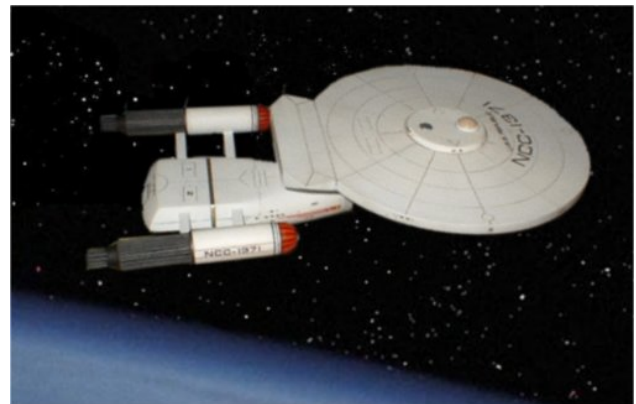

*U.S.S. Republic (NCC-1371)*



Automated surveybots on Lalande VIII (c.2205)

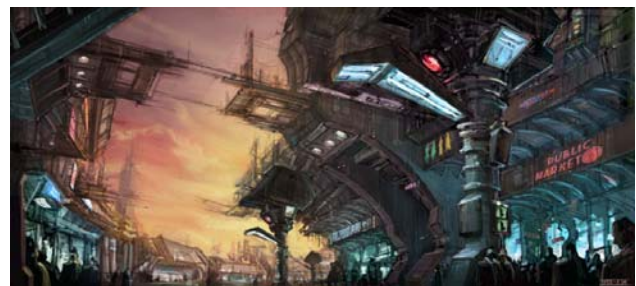

A typical day at the Orion colonies (c.2210)

# **23<sup>rd</sup> CENTURY**

---

**The Age of Advancement  
(2191-2295)**

# 2191-2220: A New Direction

---



By the beginning of the 23<sup>rd</sup> century Star Fleet knew where it needed to go in with its next generation of starships. All of the experimentation over the past 25 years had paid off in the form of a series of design specifications that, once combined, would produce the ideal starship. These were a flattened, preferably thin disc-shaped primary hull; a streamlined “Block IV” style secondary hull, and twin warp engines on booms mounted up and away from the secondary hull.

There were two more hurdles Star Fleet had to jump before it could start work in earnest on its next generation of starships. The first was the obvious cost. The recent funding cuts made in Star Fleet’s appropriations from the Federation Council limited just how “modern” an all-new build program could be. In order to be cost-effective this new program would have to be a mix of both old and new: just enough old in the right places to keep the budget down while as new as possible everywhere else. The second was limited yard space. Star Fleet still had several ship classes building, both from older programs and from many side projects (such as science and survey vessels) mandated by the Federation Council. In addition, many civilian spaceyards that had once catered exclusively to Star Fleet now had slipways full of civilian spacecraft of all kinds, with more on order for this ever-expanding market. Vickers Shipbuilding was the one spaceyard with space available (saved, in fact) for a new starship program. The new ships that Star Fleet was proposing, though, could not be built by Vickers alone. It simply didn’t have the capacity to fabricate all of the major components and control systems by itself. Many of these would be brand new

and had never been incorporated into a single Star Fleet vessel before. A solution would have to be found to all of these issues before Star Fleet could proceed with its next generation starship program.

The famed Terran scientist Thomas Alva Edison once said that “necessity is the mother of invention.” So it was that Mark Chausser of Chiokis Starship Design, the lead engineer for Star Fleet’s next generation starship program, proposed a innovative (and rather radical) solution in early 2201. Instead of awarding a full naval construction contract to a single contractor, multiple contracts would be awarded for individual components – such as what Star Fleet was already doing with its warp engines. One major contractor (in this case Vickers Shipbuilding) would be in charge of the hulls and frames, while Star Fleet itself coordinated the work of component contractors and supervised final starship assembly. The finished starship could then be launched in considerably less time than it would take to have one contractor do everything for Star Fleet. The potential savings in administrative costs alone were significant. This method would also free up more yard space for additional construction, since less dock time would be required for a given build class under this scheme. Construction of individual components would take place in parallel in smaller facilities. Only when the time came for final free-space assembly of the frame and all of its components would a starship-sized spacedock be required. An obvious side benefit of such a program would be standardized starship components. These could then be interchanged across vessels in the same class, starship classes using similar components, or even arranged in different configurations for new starship classes. It seems so obvious today but at the time it was a major breakthrough in starship design philosophy. Chausser called this the *modular component procurement program*. Star Fleet’s Starship Design Bureau called it a godsend. This program was first implemented with the *Baton Rouge* and *Ranger* class

cruisers program in 2205. It has remained the standard for Star Fleet starship design ever since.

---

As part of its move to keep the costs down on its next generation of starships, Star Fleet switched warp engine suppliers for the first time in its history. There was no question that the Cochrane Dynamics PB-18 series was going to be one of the best warp engines of its generation, given its maker. Unfortunately, Cochrane was still having problems working out technical glitches with the energy regulation systems of the PB-18, meaning it would not be ready in time for the new starship program. Facing a looming production deadline and the potential for rising development costs, Star Fleet had no choice but switch suppliers and go with the VX-28 “Pegasys” warp engine from Kloratis Drive Systems. This was an opportunity heaven-sent for this Tellarite firm, which had already proven its capabilities twice before with the *Baikonur* class cruisers and the revamping of the *Tritium* class battlecruisers during Star Fleet’s experimental period (2166-2190). The new VX-28 had already been suggested for the *Mann* class survey cruisers but had been passed over due to mount incompatibilities with the *Mann* hull design. Their overall similarities to Cochrane’s Perth PB-series, however, made them an excellent substitute for the problem-plagued PB-18. They would perform exceptionally well with the Jeffries-type hull configuration being adopted for Star Fleet’s next generation starship program. The Kloratis VX-28 “Pegasys” warp engine was one of the best designs of its generation. It would also become the visible trademark of all *Baton Rouge* generation starships.

Star Fleet would eventually adopt Cochrane-derived warp engines again in a few short years for other starship classes. Nevertheless, Star Fleet engineers would always have a special place in their hearts for their “odd child,” as they lovingly called the VX-28 “Pegasys.” Although somewhat less powerful than Cochrane’s original PB-18 design, the VX-28 was easier to operate and required minimal maintenance

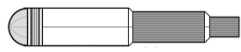

in comparison. It was the first modularized Star Fleet warp engine that was rated for a cruising speed above Warp 4. It was also the last operational Star Fleet warp engine produced before the dawn of dilithium-regulated designs. It is interesting to note that even today Star Fleet has yet to completely abandon the venerable VX-28 despite its “odd child” status. One can still find several of them at every starbase and major port facility, ostensibly for the few *Baton Rouge* era starships still in fleet service. There is a method to this seeming madness, however. It was not unheard of during the Four Years War for a damaged Class I starship with warp engines beyond repair to be temporarily fitted with VX-28s in order to get it operational again. Such seems to be part of the reasoning behind Star Fleet’s continued maintenance of its remaining VX-28 inventories around the Federation. Its excellent operational record, despite its age, has no doubt ensured that Star Fleet will keep the VX-28 around, even if only as a quick-fit “fill-in” engine, for years to come.

---

The use of the Kloratis VX-28 “Pegasys” warp engine was not the only compromise Star Fleet had to make with the *Baton Rouge* generation. The secondary hull for the program was nothing close to what had originally been planned. That too was a necessary, cost-savings compromise. In order to gain support for the *Baton Rouge* generation Star Fleet had to court some of its fiercest political foes, ones who had long been advocates of the old Terran “slab hull” designs. It didn’t matter that this particular design philosophy had reached a dead end. What was needed were construction funds and political support in the Federation Council if Star Fleet was going to get all the ships that it wanted. Both Mark Chausser and his assistant Franz Joseph IV were upset when they heard about this. They understood, though, that insofar as this generation of Star Fleet vessels were concerned they couldn’t have their cake and eat it, too. The most important thing, as Star Fleet liaison

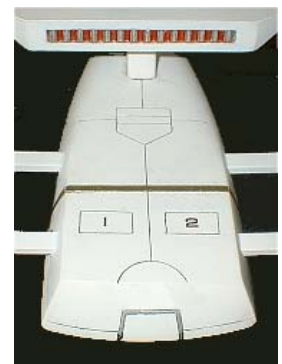

Captain William van Anling pointed out, was to get them to accept the new primary hull saucer. Once that was in place then the rest of the Jeffries Project concept would follow. It was a natural, given what was already happening with the experimental *Mann* class cruisers. Of all the parts of the *Baton Rouge* design that were required, the secondary hull was the only one left that could be compromised. The real next generation design – “Project Starship,” as some jokingly called it – would have to wait a few more years until Star Fleet could be confident of Federation Council approval. Chausser and Joseph grudgingly agreed to incorporate a redesigned “slab hull” type secondary hull into the *Baton Rouge* program as close to Jeffries Project specs as this antiquated philosophy permitted. In the meantime, though, Chausser kept himself busy working up a “real” secondary hull once the time was right to for it to be accepted. He never got the chance to see it become reality.

Mark Chausser, the genius behind the *Baton Rouge* generation of starships, the creator of the Star Fleet primary hull saucer, and the man who almost single-handedly changed the direction of Star Fleet starship design, was tragically killed in a shuttlecar accident in 2204. He was on his way to a meeting of the Procurement Sub-Committee of the Federation Council when he was hit head-on by a drunk driver. Chausser was killed instantly. He never got to see the new generation of starships that he helped bring about come to life. Franz Joseph IV, his protégé, who was only twenty-nine at the time, succeeded him as chief starship designer of Chiokis. It would be up to Joseph to oversee his mentor’s dream as it became reality ... and to make sure that no compromises were made once it came time for Project Starship’s turn at the docks.

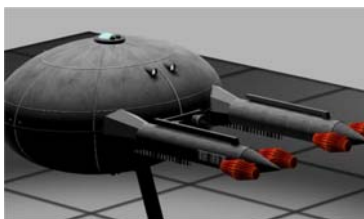

For all that it was about to do for Star Fleet and the Federation, there was one honor that would forever be

denied the *USS Baton Rouge*. On 27 May 2192, the new survey cruiser *USS Mann* officially broke the legendary Warp 4 barrier. It achieved and maintained a cruising speed of Warp 4.2 for three hours without any signs of stress to its hull or frame. Later space trials would push the cruising speed limit up to Warp 4.5 as far as the *Mann* and the rest of its class was concerned. The event was hailed in the press of the day as the most significant in the history of warp drive since its invention by Zefram Cochrane. To be more accurate, though, it proved Mark Chausser’s theory that the use of a trititanium frame would remove all known limits on starship design. Warp engine upgrades would allow the similarly equipped, older *Horizon* and *Archon* class cruisers to also exceed Warp 4 by the time the *Baton Rouge* neared completion. The *Baton Rouge* class and its derivatives, the first with all-trititanium hulls and frames, would be the first to exceed Warp 5. The situation that had so plagued starship designers in the 21<sup>st</sup> and 22<sup>nd</sup> centuries was now effectively reversed. From this point forward it would be the warp engines, not the hull or space frame, which would effectively limit just how fast a properly designed 23<sup>rd</sup> century starship could go.

During the past decade all research on the *materializer*, the ancestor of the modern transporter, had come to a virtual standstill. The issue of its use with living organic matter, such as an intelligent lifeform, had been bogged down in Federation courts due to ethical concerns. The key question at the heart of the matter was this: did a being put through a materializer “die” in the process? In other words, was the lifeform that came out the other side the same one that had gone in? The case eventually worked its way up to the Federation Worlds Court, which made its landmark ruling on the subject in 2200. Its summation reads as follows:



As has been demonstrated to the satisfaction of this Court, the essence of Materializer operation is the total conversion of a living being from a matter state to a pure energy state, transporting that energy over a distance while maintaining its cohesion, then

reversing the process and totally converting said energy back to a matter state identical to its previous form with the use of a previously stored pattern. As the conversion from matter to energy is total and complete, as cohesiveness is maintained in transit, and as reconversion is in effect a successful total reversion of said process, then there is no chance for the quality known as life to be lost through the use of a Materializer save for problems with the equipment or a premeditated act. This is in effect the same guiding principle as for any other tool, instrument, or system with the potential to cause harm to or take the life from any being. To this end this court sees no ethical issues associated with the use of the Materializer on a living being so long as the proper safety precautions are taken with regards to operating procedures and the equipment involved. This court rules in favor of the Defendant.

With those words the Federation Worlds Court cleared the last remaining hurdle in the development of what we know today as transporter technology. Star Fleet, realizing its implications, promptly threw its backing behind the efforts of the renewed research effort at the Deneva Research Station. In 2206 the first successful transport of a living being with a materializer was conducted at the Deneva Research Station. In 2208 the *Baton Rouge* class starships *USS Moscow* and *USS Tehran* participated in the first successful shipboard test of materializer technology. Within a few years they would become a standard part of shipboard systems aboard all Star Fleet starships. Materializers would never completely replace short-range shuttlecraft and warp shuttles for various reasons (such as energy field interferences); however, within the century they would become the preferred method of transit for all Star Fleet landing party teams and Star Fleet Marine insertion/extraction operations.



It is a fact of technology that one important breakthrough inevitably leads to another. William Abramson's development of the theory of transtator physics led to the invention of the transtator by Vukovic and Govindarajan. This is



the fundamental building block on which all of modern Federation computer and electronics technology is based. The development of the transtator in turn enabled Dr. Richard Daystrom, one of the Federation's most pre-eminent computer scientists, to bring to life a theory he had been developing since his teenage years. There is not space enough in this document to describe how he took his dream and



made it reality. Suffice it to say that when he was done, his *duotronic computer system* revolutionized the industry. It changed the face of applied Federation computer technology as thoroughly as did the introduction of the first personal computers in Terra's late 20<sup>th</sup> century. Once again, the power and processing capabilities of systems that had once filled rooms and even whole buildings became available in small and compact form. The impact on the starship industry alone was enormous. Duotronic-based ship's computers, among the largest such systems of their day, were capable of controlling and



regulating every single major function of a starship with only routine crew maintenance. This alone freed up manpower previously needed for starship operations, which resulted in less deck and more science personnel being assigned to Star Fleet vessels. The most important asset of a duotronic ship's computer, though, was its split-second ability to dynamically control and adjust a starship's warp field. This allowed Star Fleet designers to not only break the old "Roddenberry Twin-Nacelle Rule" but to solve all the problems associated with the old tri-nacelle configuration in one stroke. Single-nacelle starships would be the first such previously "impossible" designs to enter service with the *Drake* and *Cooke* class starships. Limited funding and Council indifference, though, did not permit Arbing and Lidde's initial proposal for a *Baton Rouge* era triple-engine dreadnought to become reality at this time. That development would have to wait several more decades and another interstellar war before it too would come to life – an "impossibility" made possible by the duotronics breakthrough.



As has been mentioned before, the energy regulation issues that plagued Cochrane Warp Dynamic's new PB-18 warp engines prevented their acceptance by Star Fleet for several years. It even caused Cochrane to lose the warp engine contracts for the entire *Baton Rouge* generation of starships. The fact of the matter was that current warp engine designs had reached their limits, yielding a designed cruising speed in the Warp 4 to 4.5 range and a designed emergency "burst" speed of Warp 6. Beyond those limits, regulating the required energy flow was practically impossible for the warp engine technology of the day to handle. The next major breakthrough in this field would be accomplished by chance. When the rubidium focusing crystal of a mining laser was broken at the Lalande VIII mining complex in 2208, a quick-thinking local engineer quickly fabbed a new crystal from a nearby dilithium deposit. The first time the rebuilt laser was tried, it had suddenly gained four times as much power despite having the same fusion generator as before. Word soon spread, with mining engineers all over the sector making the same adaptations to their equipment. It was inevitable that Star Fleet would learn of this discovery and pass it on. As the reader might have guessed, this discovery would eventually lead to the development of phaser technology some four decades later. More important for its time, however, the unusual energy moderating properties of dilithium crystals proved the solution to the problems plaguing Cochrane's PB-18 warp engine.



Dilithium-moderated PB-18s first saw service in 2209 with their successful refitting to several *Horizon* class cruisers. All of the *Horizon* and *Archer* class cruisers would receive the PB-18 by 2220. An improved design, the PB-20, was first tested with the cruisers *Constellation* and *Republic* in 2214. It was not that much of an improvement, though, given its high cost, and overall performance was essentially the same as the



older PB-18. This would cause Star Fleet to revert to the PB-18 as a cost-savings measure once it came time for the Class I Program to get underway.

It was a good thing that the modernization of Star Fleet was no longer being neglected. A new threat to the *Pax Federationis*, as some called the long peace that followed the Romulan War, was making itself felt on the Federation border beyond the Rigel sector. As in the days before the Romulan War, Federation starships were disappearing or being attacked by a mysterious foe. The Orions obviously knew who they were; however, the Orions weren't talking. A chance encounter by Federation trader E.A. Jacoby would not be realized for the significant event that it was and his first contact report subsequently lost in bureaucratic red tape. The attack on the transport *Millie Sue* and the subsequent attack on the Star Fleet vessel *Sentry* proved to all concerned the overt belligerency of the "newly discovered" Klingon Empire. Unlike the Romulans, though, the Klingons were openly aggressive and showed no fear of Star Fleet's current border forces. The *Baton Rouge* and her sister ships were subsequently rushed to the border as fast as they could be completed, where their sudden appearance had the desired effect. The number of Klingon border incidents went on a marked decline, with only the occasional incursion or ambush taking place for the next few decades. War with the Klingon Empire seemed a certainty in the near future given its bellicose nature. Even so, the introduction of the *Baton Rouge* generation of starships is credited by many with delaying the start of that war for decades.



# MAJOR EVENTS

## 2191

- The *Kepler* series space probes enter service.
- The first of several sightings of unknown, manta-shaped alien craft begin on the edges of Federation space beyond the Rigel star system.

## 2192

- The *Mann* class survey cruisers enter service. These are the first starship class in Federation history that can maintain a cruising speed of Warp 4, thanks largely to their trititanium frames.
- The last of the original, pre-war *Horizon* class starships is retired (its class name already reassigned to the 2190 survey cruisers of the same name). All of these will be sold off to eager civilian buyers and enjoy extended lifespans as civilian transports.



## 2193

- All starships in the *Tritium* class are withdrawn from service. This is due both to the emergence of the *Horizon* and *Mann* class starships and to continued safety concerns about their flawed design. The lead ship, *USS Tritium*, will be donated to the Star Fleet Museum at Memory Alpha while the rest are scrapped.
- The *Orpheus* space probe is the first to apparently survive descent into a black hole. Its last recorded transmission happens a fraction of a second after it passes the black hole's event horizon, after which it is never heard from again. The data suggests that the old theories about black holes being gateways into other dimensions might be true after all.
- The *Provider* class space tug enters service.
- Birth of Sarah Anne Poole, future wife of Robert April and future first chief medical officer of the starship *Enterprise*.

## 2194

- The *Castor* class cruisers are withdrawn from service.
- The Back-to-Earth Movement is founded at the Benecia Colony.
- The *Rickenbacker* class "Flying Fortress" enters service.

## 2195

- For the next two years, Star Fleet will experiment with a new prototype battlecruiser based on the *Horizon* class starships. The *USS Sigma* itself will never enter service; however, many of its advances will make their way into future Star Fleet starship designs.

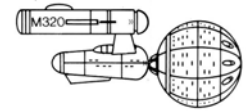

## 2196

- The last of the *Daedalus* class starships is decommissioned. Eleven are kept in the Star Fleet Reserve (including the *USS Lowell*) while the rest are scrapped.
- The first of several mysterious disappearances of Federation civilian craft begin to occur in the border space beyond the Rigel sector. Locals quickly tie the incidents to the alien, manta-shaped craft that have recently been spotted in the area.

## 2198

- For the next two years Star Fleet will evaluate the prototype for its first shuttlecarrier. While the *Illustrious* herself will only see limited service, lessons learned from it will make their way into the design for the secondary hull of the *Baton Rouge* class cruisers.
- The *Lowell* class scout enters service.
- The Back-to-Earth movement continues to gain momentum within the United Earth Government and its former colony worlds, creating heated debate on both sides of the issue.

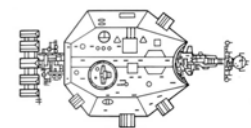

## 2199

- A new series of high-speed interstellar pleasure craft enter the civilian starship market. As one wag put it, "If you have to ask the price then you can't afford them."

## 2200

- The *Archon* class heavy cruisers enter service.
- The *Ariadne* class clipper enters service.
- The *Byrne* class hospital ships are withdrawn from service.
- The *Tetsujin* class ringship is withdrawn from service.

- The largest spacelift in Federation history finishes evacuating all 10 million inhabitants of Bayard's Planet shortly before the shockwave from the Phi Puma supernova washes across the system.
- The Federation Space Marines, which up until now had been an independent organization, are brought under the aegis of Star Fleet and reorganized as the Star Fleet Marines.
- The Federation Worlds Court issues its landmark ruling regarding materializer research. It finds no moral, ethical, or legal objections to the dematerialization and rematerialization of organic matter. In short, all that is involved is the conversion of living matter to a state of pure energy and then back again without loss of life. So long as there is "lossless" conversion (via a transporter matrix) then the materializer (transporter) is incapable of taking life away from organic matter without a deliberate, pre-meditated act – the same as for any other tool or device. This clears the last major legal hurdle for Dr. Janet Hester's Materializer Research Project.

---

**NOTE:** The Federation Worlds Court's approval of the use of materializers on living matter cleared the way for the development of transporter technology as we know it today.

---

- Legal hurdles now cleared and with new Star Fleet backing, the Deneva Research Station resumes its research into making materializers safe for the transport of organic matter, including living beings.

## 2201

- The *Hunter* class corvette enters service.
- The United Federation of Planets now has over 500 members and affiliated systems. It has become so large that only major grievances can be dealt with in the Federation Council. This is a growing source of concern among many.
- The Federation Council finally grants its approval for Star Fleet to begin building its next generation of starships. Upgrades to suitable older starship designs will be performed on an as-needed basis.
- Star Fleet Division is founded under the aegis of Star Fleet's Starship Design Bureau to oversee all new Star Fleet shipbuilding efforts. Its first major task will be to gather materials, issue contracts, and secure yard space for Star Fleet's new shipbuilding program.



## 2202

- The *Boyden* class transports are withdrawn from service.
- Production ends on the Stellarford Shuttleplane.
- Hydra II is discovered by the *USS Poseidon*. It is the first pelagic planet (waterworld) ever found by a Federation starship. This the first (and last) time that Hydra will not be beset by scores of Federation tourists or groups of Star Fleet personnel on shore leave.
- The Galactic Cultural Exchange Program puts on a Federation-wide fair that will be the stuff of legend among scholars and liberal-minded Federation citizens in later years.



## 2203

- The *Cahuya* class survey cruiser enters service.
- Star Fleet's massive CR594 mobile construction rig enters service.
- The lead vessels in the *Baton Rouge* and *Ranger* class starships begin simultaneous construction under the supervision of Star Fleet Division at the San Francisco Navy Yards (*Baton Rouge*) and the Vickers Shipbuilding Spacedocks (*Ranger*) in orbit above Terra. These will be the first starship classes in Federation history with full tritanium hulls and frames and are designed with Warp 6 operations in mind. They will also be the first Star Fleet vessels to utilize a modular component construction system for easier maintenance and upgrades. Both spaceyards are soon racing each other as much as safety procedures allow in order to see who finishes their new starship first.
- Star Fleet encounters the Klingons in battle for the first time in the *Millie Sue* Incident, although their identity is unknown at the time.
- The Richter Scale of Planetary Culture is published by academician Alonzo Richter.
- Kelvar Garth, the greatest starship commander of his generation, is born on the planet Izar.



## 2204

- The *Bering* class automated tanker enters service.
- Amanda Grayson, future second wife of Sarek of Vulcan, is born.
- Mark Chausser, father of the *Baton Rouge* generation of starships, is tragically killed in a shuttlecar accident outside of Paris, France. His young assistant Franz Joseph IV succeeds him as head of the program.

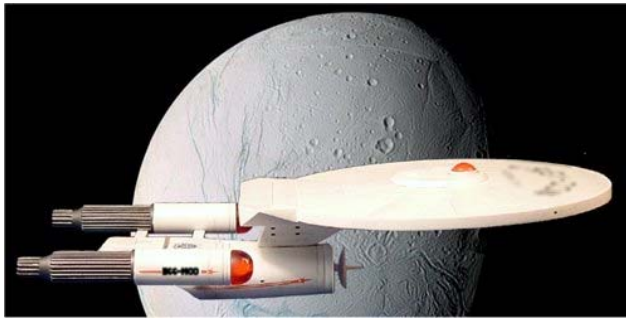

## 2205

- The new heavy cruiser *USS Baton Rouge* is launched a mere 7 hours, 12 minutes, and 3 seconds ahead of its dockyard competitor, the survey cruiser *USS Ranger*. It will become the namesake of its generation of Star Fleet starships.
- The starships *Baton Rouge* and *Ranger* are commissioned into Star Fleet and promptly undergo their initial shakedown cruises. Their revolutionary new design, incredible performance, and ease of operation cause a sensation both with Star Fleet personnel and with the general public.
- Birth of Matthew Decker, future Star Fleet commodore.

## 2206

- Dr. Richard Daystrom makes his initial breakthrough in the development of duotronic computer technology. His invention will forever change the Federation computer industry.



**NOTE:** Duotronic computers were the first with enough sophistication to handle “on-the-fly” manipulation of a starship’s warp field. Their invention made possible starship designs outside the standard twin-nacelle configuration and added greatly to a starship’s performance at warp speed.

## 2207

- Growing dissatisfaction with the new, centralized Federation government brings about increasingly strident calls to dispense with the Federation Charter and revert to the more decentralized government of the old Articles of Federation. The Back-to-Earth Movement uses this dissent to increase its membership.

## 2208

- The *Watt* class cargo tugs are retired from service.
- The last of the *Tritium*’s personnel shuttles are retired from service.

- The *Masters* class interstellar tug enters service.
- A chance discovery on the Lalande VIII mining colony reveals the unusual energy-moderating properties of dilithium crystals. Its implications in the field of warp engine technology are immediately obvious to all.
- Federation museums and private gemstone collectors reap enormous profits from the stores of dilithium crystals they have kept for years, unaware of their true nature or value.

**NOTE:** The discovery of dilithium’s energy moderating properties allowed Cochrane Warp Dynamics to solve the problems it was having with its PB-18 warp engines. The final production version of the PB-18 would be the first dilithium-moderated warp engine to ever see service with Star Fleet. Dilithium moderation has been a standard feature of all Star Fleet approved warp engine designs ever since.

- The first Star Fleet approved duotronic computers are installed on the *Baton Rouge* and *Ranger* class starships currently under construction. They will be quickly back-fitted onto vessels already in service.
- The first successful “transport” of a humanoid with a materializer (transporter) takes place between the *Baton Rouge* class starships *Moscow* and *Tehran*. Within the year materializers are being back-fitted onto all Star Fleet starships, with the *Baton Rouge* and *Ranger* classes having top priority, as fast as they can be built.

• Perceptive minds at Star Fleet’s Starship Design Bureau see in the “doodles” of Chiokis lead designer Franz Joseph IV the inspiration for the generation of starships that will follow in the *Baton Rouge*’s groundbreaking footsteps. They begin working with Joseph to turn his “doodles” into a buildable starship design. This is the origin of the legendary Class I Program of starships, the successors of the *Baton Rouge* program and the foundation for today’s Star Fleet.

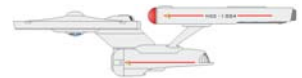

## 2209

- The *Constant Warwick* class light cruiser enters service.
- A number of terrorist strikes by dissidents upset with the “totalitarian” Federation government threaten its interstellar economy. The Federation Council has no choice but to enact harsh security measures in order to bring the terrorist to heel. This move stops the terrorism but only adds fuel to the fires of dissent building within the Federation.

- The first documented case of *transporter psychosis* occurs during its early use aboard Star Fleet starships.

## 2210

- The *Hale* class scout enters service
- The *Hercules* class transport enters service
- The *Anton* class cruiser enters service.



CONSTELLATION in 2211

- With approval from Star Fleet, the *Horizon* class heavy cruiser *Constellation* (known affectionately as "*Connie*" to her crew) is taken to the San Francisco Navy Yards for fitting with a new version of the Chiokis thin-disc primary hull saucer. This configuration is intended to test the possibilities of the 2208 Joseph concept. The yard will also have to rework the *Connie's* secondary hull so that the new saucer can clear the engine booms. This conversion will take just under nine months to complete.



REPUBLIC in 2211

- About the same time, the *Baton Rouge* class cruiser *Republic* is withdrawn from service and also taken to the San Francisco Navy Yards for a slightly different conversion. It will be testing a new secondary hull design and is also reconfigured according to the 2208 Joseph concept. This conversion will take just over a year, since the *Republic's* basic frame has to be altered for the conversion.

## 2211

- The *Cabot* class trawler enters service.
- The Star Fleet Association is formed to look after all Star Fleet vessels that have been retired and converted into museum ships.

## 2212

- The photon torpedo is developed.
- The *Kepler* class deep space stations enter service, not to be confused with the *Kepler* space probes (or later *Kepler* class transport/tug).

## 2213

- The Perth PB-20 "Ajax" warp engine is developed.
- The *Bode* class scout enters service.



CONSTELLATION in 2214

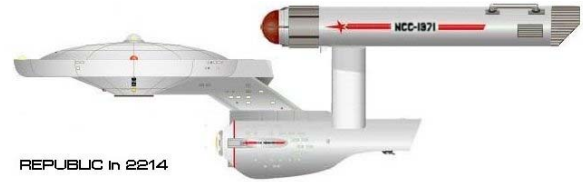

REPUBLIC in 2214

## 2214

- Dilithium-moderated PB-20 warp engines are fitted to both Joseph prototypes (replacing the *Connie's* PB-17s and the *Republic's* VX-25s) to evaluate their potential with the program.
- The starship *Valiant* is lost in the line of duty.
- The *Detroyat* class heavy destroyer enters service. It is the first Star Fleet starship with photon torpedoes.
- Christopher Pike is born 11 April in Mohave on Terra.

## 2215

- The *McCormick* class factory ships are withdrawn from service.
- The Federation Council authorizes another production block of *Baton Rouge* class heavy cruisers reconfigured for the multi-mission role. This will form the *Nardenskjold* sub-class.
- Based on testing data so far on both Joseph Program prototypes, the *Constellation* is fitted with a modified version of the *Republic's* new secondary hull. This is because the *Connie* has been the better performer of the two prototypes during testing. This will be the final design change made to the program prototypes.



CONSTELLATION in 2215

---

**NOTE:** By this point in time, as one can see, the modified *Constellation* is for all intents and purposes a Class I heavy cruiser. Because of this it is regarded by some starship historians as the first Class I starship, preceding the *Constitution* by seven years. It will serve as the basis for that program and later be upgraded to match the other ships in the class. Its origins as a *Horizon* class heavy cruiser, though, will leave it with slight variances in its design that only a trained eye will be able to spot.

---

## 2216

- The *USS Dewey* is decommissioned.
- Based on the test results from the *Constellation* and *Republic*, the Starship Design Bureau lays out its final specifications for the next wave of starship classes that will follow the *Baton Rouge* generation. The first design in the new Class I Program will be a heavy cruiser patterned after the *Constellation* prototype. This will be a multi-mission starship, suitable for both military and survey roles, replacing both the *Baton Rouge* and *Ranger* class programs. The second design is for a single-nacelle starship suited for the destroyer and scout roles. These will replace both the *Drake* and *Cook* class starships, and they will be cancelled in favor of their successors. The third is for a Class I transport/tug with a new and larger container pod system, replacing the one originally developed for the *Watt* class transport.
- The decision is also made to go with the older (and less expensive) PB-18 warp engine for the new Class I Program instead of the newer (and more expensive) PB-20. This is a throwaway move intended to help gain approval for the Class I Program from the Federation Council. Star Fleet plans to upgrade all Class I starships with the PB-20 or its successor once the necessary funding becomes available.

## 2217

- The *Patton* class destroyers are withdrawn from service.
- Star Fleet's submission for its new Class I Program of starships is flatly rejected by the Federation Council. The reason given is that there is no need for such an expansive program given the already expensive outlays for the various *Baton Rouge* related programs.

## 2218

- The *Nordenskjold* class survey cruiser enters service.
- The *Drake* class destroyer enters service.
- The *Cook* class scout enters service.
- The *Sentry* Incident ignites hostilities with the Klingon Empire.
- Leonard Horatio McCoy, future chief medical officer of the starship *Enterprise*, is born 20 January on Terra in the American state of Georgia.
- The reconfigured starships *Constellation* and *Republic* rejoin the fleet. According to certain starship historians this event marks the "real" beginning of the Class I Era.



## 2219

- The possibility of the first interstellar war in six decades causes a split Federation Council to approve funding for Star Fleet's new Class I Program of starships.
- The keel of the heavy cruiser *Constitution* is laid down in spacedock at the San Francisco Navy Yards at Terra. Officially, it will be the first starship in the Class I Program.

## 2220

- The *Palomar* class starships are withdrawn from service.
- The keel of the heavy cruiser *Enterprise*, the second starship in the Class I Program and destined to become the most famous starship in Federation history, is laid down in spacedock at the San Francisco Navy Yards at Terra.



Star Fleet Marine anti-terrorist operations (c.2210)

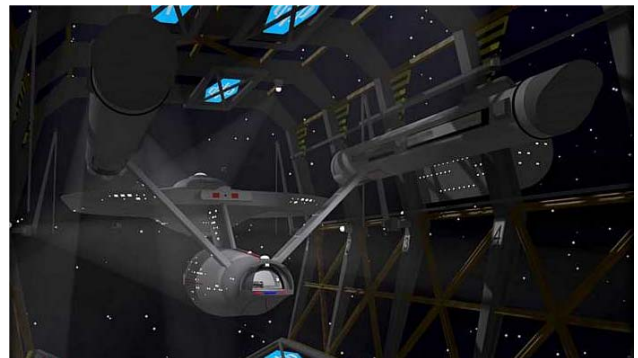

*Constellation* during her final prototype retrofit (2215)

# STAR FLEET STARSHIPS

## ***MANN* CLASS SURVEY CRUISER**

**SERVICE ENTRY DATE (OLD CALENDAR): 2192**



The *Mann* class was named for Captain Stuart Mann, the late commander of the *USS Horizon* and one of the true pioneering starship captains of the *Pax Federationis*. These were built by Chiokis Starship Design under the pretense of being scientific and exploratory vessels; in effect, less expensive stablemates to the *Horizon* class starships. The real purpose of the *Mann* class, however was to break the legendary Warp 4 barrier. To that end the secondary hull was sacrificed and all ship's functions concentrated within a "bloated disc" primary hull, with its twin warp nacelles mounted directly on its backside. The limits of its internal volume obviously limited its mission profiles, a fact which the Federation Council either did not notice or chose to ignore when they authorized 12 ships in the class for construction. The custom-built Vickers J27-A warp engines (licensed from an experimental Cochrane design) and Chiokis-designed trititanium frame allowed the *USS Mann* (NCC-750) to hit and maintain a Warp 4 cruising speed on its very first space trial. The *Mann* and its siblings would go on to carve their own niche in Federation spacecraft history despite their "little brother" status to the mighty *Horizon* class.

Starships of the *Mann* class seemed to be everywhere during this part of the *Pax Federationis* (2163-2245). In 2198 the *USS Leonidas* (NCC-752), under the command of Captain Pyotr Mirabella, was successful in locating and securing a "Flying Fortress" that had been spacejacked by pirates and was about to be liberated of its cargo (an experimental improved Star Fleet deflector system). In 2200 the *USS Endurance* (NCC-757), under the command of Admiral Okuru Nelson, oversaw the final stages of the evacuation of all 10 million inhabitants of Bayard's Planet before its surface was ravaged by the radiation-soaked shockwave from the Phi Puma supernova. Also in 2200, the

*USS Sagan* (NCC-758) became the first Star Fleet vessel in history to have an all-Andorian crew. In 2202, the *USS Poseidon* (NCC-755), under the command of Captain Marvin D. Goodwell, entered orbit around the planet Hydra II and thus discovered the first pelagic planet in the history of Federation space exploration.

The very design that had enabled the *Mann* to become the fastest starship of its day ultimately proved to be its undoing. Its restrictive internal hull volume, comparable to that of a *Horizon* class starship's secondary hull, severely limited the amount and types of upgrades it could receive. The class was eventually retired from Star Fleet service in favor of the *Ranger* class, its *Baton Rouge* era successor, in the early 2220s.

### **SPECIFICATIONS:**

Length .....	185 m
Beam .....	101.7 m
Draft .....	40 m
Mass .....	54,000 DWT
Crew .....	294
Range .....	8 years at L.Y.V.
Armament .....	6 laser banks 2 fusion torpedo tubes

Cruising speed: .....	warp 4.0
Maximum speed: .....	warp 4.5

#### Innovations:

- First Star Fleet starship capable of maintaining a Warp 4 cruising speed
- First starship in Federation history to achieve a 1:1 matter/antimatter intermix ratio with its warp engines
- First Star Fleet starship to be fitted with a dual purpose sensor/deflector grid system on its hull.

### **SCHEMATIC:**

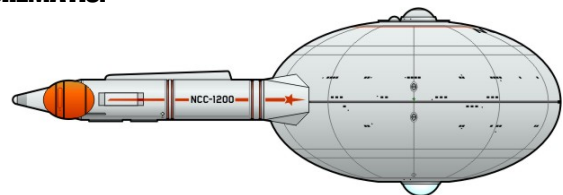

**MANV DESIGN BY RICK STERNBACH  
SCHEMATIC BY HARRY DODDEMA**

# RICKENBACKER CLASS

## “FLYING FORTRESS” TRANSPORT

**SERVICE ENTRY DATE (OLD CALENDAR): 2194**

The “Flying Fortress” was specifically designed to provide the most secure means possible of transporting extremely valuable cargoes across Federation space. To that end the *Rickenbacker* class transport carries cruiser firepower in addition to double shielding, old-style ablative armor, and triple-layer armored cargo holds with a fully armed security detail on board (or Marines, if in Star Fleet use) for extra protection. Its cargoes have covered the full range of Federation valuables, from a single bottle of Saurian brandy of rare vintage to holds full of pressed latinum bars for interstellar commerce. Only once in its official service history has a “Flying Fortress” been successfully attacked and disabled, but even then its badly mauled hijackers were unable to penetrate the multiple layers of its armored holds in time before Star Fleet arrived on the scene and finished them off. These vessels have since been replaced in mainstream commerce by more modern designs; however, one can still occasionally encounter a “Flying Fortress” operating in the outer sectors of Federation space.

### SPECIFICATIONS:

Length: .....	310 m
Beam: .....	195 m
Draft: .....	185 m
Mass: .....	190,000 DWT
Crew .....	422 (not including security/Marine detail)
Armament .....	20 laser banks 12 fusion missile tubes (later converted to phasers & photon torpedos)
Cruising speed: .....	warp 4.0
Maximum speed: .....	warp 4.5

### SCHEMATIC:

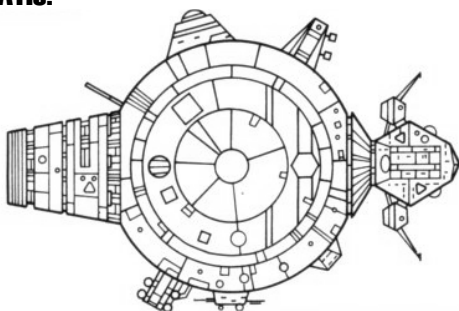

RICKENBACKER DESIGN BY RICK STERNBACH

# USS SIGMA

## PROTOTYPE BATTLECRUISER

**SERVICE ENTRY DATE (OLD CALENDAR): N/A**

The prototype *Sigma* was a one-shot design developed to see how well a *Horizon* class hull could perform in the battlecruiser role. It was inspired by the success of the smaller *Baikonur* in 2183. That had pushed the original *Daedalus* design to its limits in terms of military applications. This upsized version featured no less than 16 lasers in dual turret mounts and 12 fusion torpedo tubes. 10 of these were concentrated on the forward part of the primary hull. This was one of the first Star Fleet vessels to embody the “massed forward firepower” concept since the *Marshall* class destroyer of the Romulan War. The theory behind this was simple and proven: if all you can get is the first strike, make sure that it is a devastating one.

The *Sigma* was thoroughly evaluated at the Arcturus Test Range from 2195 to 2197. Although the design itself never entered production, many of its system advances found their way onto the *Baton Rouge* generation of starships. The “massed forward firepower” concept would eventually return to Star Fleet, though – first with the *Marklin* class destroyers, and more recently with the *Abbe* class torpedo destroyers.

### SPECIFICATIONS:

Length: .....	225.1 m
Beam: .....	117.0 m
Draft: .....	45.5 m
Mass: .....	24,500 DWT
Crew .....	157
Armament .....	16 laser banks (8 dual turret mounts) 12 fusion torpedo tubes
Cruising speed: .....	warp 3.6
Maximum speed: .....	warp 4.8

### SCHEMATIC:

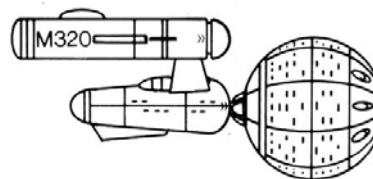

SIGMA DESIGN BY RICK STERNBACH  
AS MODIFIED BY LAWRENCE MILLER



# ILLUSTRIOUS CLASS SHUTTLECARRIER

**SERVICE ENTRY DATE (OLD CALENDAR): 2198**

This behemoth starship, the largest yet ever operated by Star Fleet in any form, has its origins in the "flying base" concept from the Romulan War (2156-2160). The success of the *Hopkins* class hospital ship and the subsequent *Byrne* class caused many within Star Fleet to wonder what might be accomplished with a purely military design. To that end they took the largely incomplete shell of what would have been Starbase 18, a victim of Council-mandated budget cuts, and converted it into a starship using whatever spare parts and components scavenged from other unfinished or cancelled starship programs it could find. The result was a 2 million metric ton flying monster with no clear purpose other than to ponder through space like some giant "death star," looking for action it was destined never to find. The ample space within its incomplete hull naturally suggested hangar bay conversion, which in turn led to the first shuttlecarrier in Star Fleet history. It formally entered service as the *USS Illustrious* in 2198, serving no fleet role other than to serve as a mobile base for shuttle pilot training. It did this for over six decades until the *Coronado* class through-deck cruiser came along after the Four Years War. It was scrapped soon afterward.

## SPECIFICATIONS:

Length:	1200 m
Beam:	515 m
Draft:	138 m
Mass:	1,989,000 DWT
Crew	600
Armament	16 laser banks 6 fusion torpedo banks
Cruising speed:	warp 3.0
Maximum speed:	warp 3.5

## SCHEMATIC:

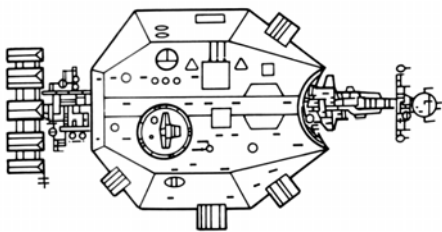

RICKENBACKER DESIGN BY RICK STERNBACH

# LOWELL CLASS SCOUT

**SERVICE ENTRY DATE (OLD CALENDAR): 2198**

This is the second of three starship classes in the so-called "Mann generation" recognized by some starship historians. It is nothing more than a scaled-down *Mann* with pylon mounted warp engines for easier upgrading and maintenance. The use of the *Mann* design as its basis all but ensured Warp 4 performance. At half the size of its inspiration, though, its interior spaces as designed were extremely cramped and reminded some grizzled Star Fleet veterans of the pre-war *Cavalry* class destroyers. In order to alleviate this situation most of the sensor suite was removed and mounted on external pods fitted amidships so as to cause minimal impact on the ship's warp field. In addition, a "drag pod" with special sensors could be deployed from a housing mounted aft, between the dual warp engine pylons.

The *Lowell* class starships were designed as high-speed scouts, capable of moving in and out of sensitive areas as fast as possible while taking as many sensor and scanner readings in the process. Its one flaw was the lack of a torpedo tube. Although not seen as an oversight at the time, the subsequent development of self-propelled sensor probes (an adaptation of torpedo technology) guaranteed the obsolescence of the class. The last *Lowell* class scout was retired in 2222.

## SPECIFICATIONS:

Length:	74 m
Beam:	28.8 m
Draft:	23.7 m
Mass:	26,000 DWT
Crew	130
Armament	
Cruising speed:	warp 4.0
Maximum speed:	warp 4.7

## SCHEMATIC:

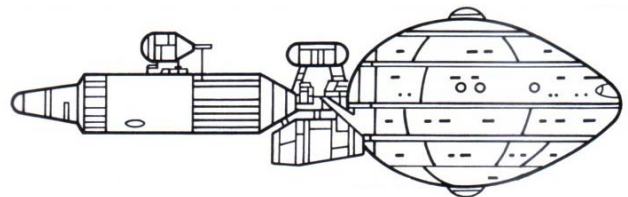

LOWELL DESIGN BY RICK STERNBACH

# CR594 MOBILE CONSTRUCTION RIG

**SERVICE ENTRY DATE (OLD CALENDAR): 2203**

These were the first rapid-deployment space docks in Star Fleet history. The intention the CR594 was to have the capability of deploying a full-fledged construction and repair facility in the field as quickly as possible whenever such was required. Warp tugs did the actual deployment, with the CR594 itself having only ion-powered station keeping thrusters for limited propulsion. In the absence of a fleet tug a special gravitic impeller drive, courtesy of Utopia Planitia Shipyards, could be fitted for transport. This was rarely used, though, limited as it was to Warp 2 due to the CR594's sheer mass. Within its frame were all the facilities and equipment necessary to build, repair, or upgrade all of Star Fleet's current and next-generation starships given proper materials. The only exception was the one-of-a-kind shuttlecarrier *Illustrious*, which was as big as the CR594 itself. The last officially left fleet service in 2253; however, most are still in operation with new civilian owners and now service Federation civilian shipping instead.

The CR594 is the direct ancestor of the "classical" series of spacedocks (*Maya*, *Roman*, etc.) in use by Star Fleet today.

## SPECIFICATIONS:

Length (with impeller): ..... 1600m  
Beam: ..... 275 m  
Draft: ..... 238 m  
Mass: ..... 2,875,000 DWT  
Crew ..... 750  
Armament ..... none

Cruising speed (impeller-equipped): ..... warp 2.0  
Maximum speed (impeller-equipped): ..... warp 2.2

## SCHEMATIC:

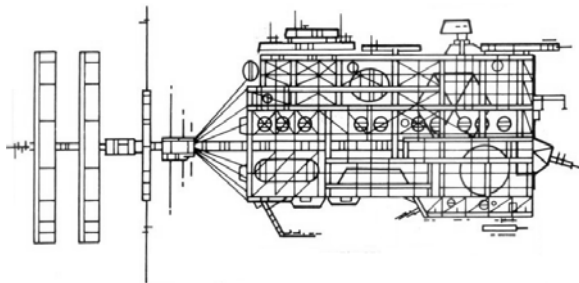

CR594 with optional gravitic impeller drive attached

CR-594 DESIGN BY RICK STERNBACH

# CAHUYA CLASS SURVEY CRUISER

**SERVICE ENTRY DATE (OLD CALENDAR): 2203**

The five ships of the *Cahuya* class represented something of a throwback insofar as starship design philosophy was concerned. Their boat-like hulls evoke images of the old Terran "slab-hull" school of design. It actually served two purposes: first, to facilitate a planetary aquatic landing; second, to maximize room for its intended suite of science labs and interstellar research facilities. The *Cahuya* class was one of only two Star Fleet starships at the time that could perform a planetary landing, however limited (the *Texas* class light cruiser being the other).

The *Cahuya* class was in almost constant deployment from the moment the first ship launched, relieving the *Horizon* class of duty as the Federation's primary deep space survey and exploration vessels. They themselves would be supplanted and then eventually replaced by the *Ranger* class in the same role within two decades. They would continue, however, for several more decades (with periodic component and engine upgrades) operating within Federation space on various and sundry science missions. The last *Cahuya* class starship was retired in 2273.

## SPECIFICATIONS:

Length: ..... 201.2 m  
Beam: ..... 119.4 m  
Draft: ..... 42.7 m  
Mass: ..... 49,200 DWT  
Crew ..... 290  
Armament ..... 6 laser banks  
1 fusion torpedo tube

Cruising speed: ..... warp 3.0  
Maximum speed: ..... warp 4.8

## SCHEMATIC:

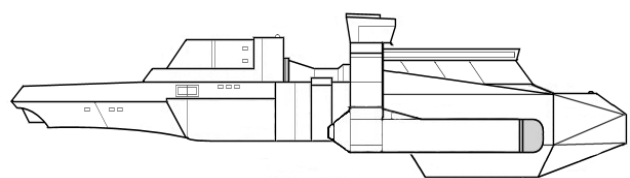

CAHUYA DESIGN BY TODD GUENTHER  
SCHEMATIC BY NEALE DAVIDSON  
AS MODIFIED BY RICHARD E. MANDEL

# ***BERING* CLASS**

## **AUTOMATED TANKER**

**SERVICE ENTRY DATE (OLD CALENDAR): 2204**

These vessels were procured for Star Fleet Transport Command for the bulk transport of liquids, slushes, and gaseous materials. The actual “ship” as such consisted of the warp engine, an interconnecting dorsal, a control deck (normally automated with provisions for a small crew as required), and container interlock modules. These interlocks allowed as many containers as needed to be attached up to the load required or the limits of the engine. The illustration below shows a fairly common three-container configuration. Configurations of six, eight, or even twelve containers were not unheard of, though, and on at least one occasion a *Bering* was configured to haul fourteen containers.

The *Bering* class remained in service with Star Fleet, with numerous system and engine upgrades, up through the Four Years War (2246-2250). They were relegated to the Star Fleet Reserve in the mid-2260s. They were finally sent to the boneyards in the late 2270s, with the last *Bering* class starship being scrapped in 2281.

### **SPECIFICATIONS (AS ILLUSTRATED):**

Length: ..... 204.1 m  
 Beam: ..... 54.4 m  
 Draft: ..... 115.5 m  
 Mass: .....173,900 DWT  
 Crew ..... none  
 Armament ..... none

Cruising speed (unladen): ..... warp 5.0  
 Towing speed (laden): .....warp 3.0

### **SCHEMATIC:**

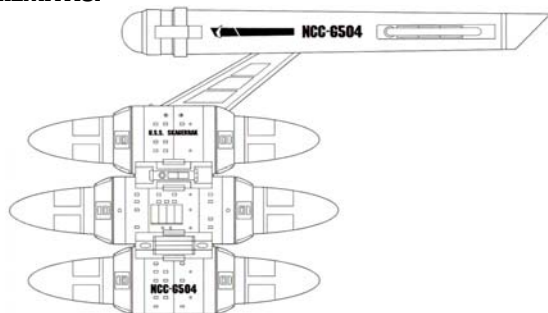

*USS Skagerrak* – as found in the Delta Triangle (2264)



A typical Federation deep space station (c.2200)



Bayard's Planet after the Phi Puma shockwave (2202)



The *SS MacArthur*, a former DY-X military cruiser that served as the testbed for the VX-28 “Pegasys” warp engine (c.2205)

*BERING* DESIGN BY DON CHRISTANSON  
 SCHEMATIC COURTESY OF FEDERATION FRONTIERS

# BATON ROUGE CLASS

## HEAVY CRUISER

SERVICE ENTRY DATE (OLD CALENDAR): 2205



*U.S.S. Moscow* (NCC-1357), Star Fleet Museum

The *Baton Rouge* class starships represented the penultimate configuration of a quarter-century worth of efforts by both the Starship Design Bureau and Chiokis Starship Design of Andor in order to come up with the best starship design for general fleet use. It was the first starship class fitted with transporter technology and the last without dilithium-moderated warp engines. It also has the distinction of being the first starship class ever built under Star Fleet's modular component program.

The visual likeness to the original Jeffries Program prototype of 2155 is striking. The main differences are due to both design and budget considerations. The all-tritanium Chiokis-style "thin saucer" was a first in Federation starship construction. An oversized "slab type" tritanium secondary hull, fitted in standard configuration under and behind the primary hull, provided additional room for survey and exploration facilities as well as one of the largest starship shuttlecraft hangers at the time. An "underslung" engine configuration had to be employed instead of the favored "overhull" one in order to offset the warp field drag of the oversized impulse deck. This had the side benefit of making the new vessel more maneuverable in warp, albeit sacrificing some speed and acceleration in the process. The Kloratis VX-28 "Pegasys" warp engines were the first time that Star Fleet had ever contracted outside of Cochrane Warp Dynamics for a major starship class. They would go on to become one of the visual hallmarks of the *Baton Rouge* generation.

An interesting experiment at the time was the use of two small warp engine support pylons per side instead of one large one. It was hoped that this would give the design more stability and allow for higher warp speeds. In reality the advantages gained

by the "thin twin boom" concept were minimal at best. The *Nordenskjold* class, the final *Baton Rouge* build group and often considered its own class due to several significant design changes, would revert back to a single support pylon system.

The use of modular construction techniques in the building of the *Baton Rouge* class, plus the push to get it into service as quickly as possible, made it one of the fastest built starship classes in Federation history. Almost every ship in the class went from base assembly of major components to final fitting of interior systems within ten months and commissioning within sixteen. The *USS Baton Rouge* (NCC-1300) beat the lead ship of the similar *Ranger* class survey cruisers out of the yard by mere hours, thus becoming the first of its generation and lending its name to this era in Federation spacecraft history.

As predicted the *Baton Rouge* modular construction program spurred the development of multiple side starship classes based on *Baton Rouge* components. Fifteen different derivative designs were planned at one time, with six actually put into production. These were the *Ranger* class survey cruiser, the *Constant Warwick* class light cruiser, the *Drake* class destroyer, the *Cook* class scout, the *Anton* class cruiser, and the *Detroyat* class heavy destroyer. A seventh, the *Marklin* class destroyer, was converted to the Class I Program just as it was about to begin construction. All of the *Baton Rouge* era designs would be incorporated into the subsequent Class I Program. This resulted in all of the older *Baton Rouge* era starship classes being cancelled, many while ships were still under construction. This explains why there are obvious gaps in starship classes when comparing the Class I and *Baton Rouge* generations, as well as the shortage of vessels in certain *Baton Rouge* era designs. The leftover *Baton Rouge* era components would be used to keep their generation in service or for experimental designs (such as the *Kearsage* class light cruiser).

A total of 25 *Baton Rouge* class starships were built between 2205 and 2212. This was the largest build class of a new Star Fleet ship-of-the-line since the Romulan War. They quickly gained a reputation as one of the best combat starships of its day. In 2219 a task force consisting of four *Baton Rouge* class cruisers successfully engaged and routed a Tzenkethi battle fleet on its way into Federation space. All of the Tzenkethi vessels were either destroyed or damaged beyond repair, with the Federation fleet suffering only minor damage in return. They would again prove their effectiveness during the early days of the Four Years War (2246-2250), holding their own against the deadly Klingon D-6 battlecruiser in the few and often lopsided encounters between the two.

In 2208 the *Baton Rouge* class starships *Moscow* (NCC-1357) and *Tehran* (NCC-1308) participated in the first successful test of starship transporter technology. Subsequent ships in the class were built with them preinstalled and the technology back-fitted into all older ships in the class. All were also upgraded with Daystrom Duotronic Mark I computers as soon as these became available. During the Four Years War all but eight *Baton*

*Rouge* class cruisers had their original Pegasys VX-28 warp engines replaced with the more powerful Cochrane Dynamics PB-32 "Titiac." All received phaser upgrades, with some having two additional single phaser banks mounted to the rear of their secondary hulls (one to each side of the hangar bay) per the *Nordenskjold* configuration. These wartime refits were expensive given the age of the class and not continued once the war was over, leaving eight unmodified *Baton Rouge* cruisers in their original configuration. These were retired as soon as post-war build strength permitted, while the remaining upgraded vessels continued to serve Star Fleet well into the Class I era.

All remaining active duty *Baton Rouge* class cruisers were decommissioned in 2263, although several still remain in the Star Fleet Reserve. The *U.S.S. Moscow* (NCC-1357), one of the two that was part of the first successful starship transporter test, and one of the few that still retains its original Pegasys VX-28 warp engines, was donated to the Star Fleet Museum at Memory Alpha and restored for public display. The *U.S.S. San Diego* (NCC-1438) is preserved as a museum ship at the Star Fleet Division Orbital Shipyards at Luna by the Starfleet Association.

The *Baton Rouge's* success as Star Fleet's premiere starship of the day is without question. Even so, certain aspects of the design continued to vex Star Fleet. The oversized impulse deck and slab-like secondary hull were design concerns that had been "allowed" to happen. This was for the simple reason that Star Fleet needed the *Baton Rouge* immediately to replace its rapidly aging Romulan War era capital ships. Both of these had also necessitated the move of the warp engines to their "underslung" arrangement, something that Star Fleet designers knew full well was not the best configuration for an optimum starship warp field. That is why, when the next generation of Star Fleet vessels went to the drawing boards, they would go back to the Jeffries Prototype one last time before deciding the future of Star Fleet starship design.

**VISUAL:**



**SPECIFICATIONS:**

Length: ..... 245 m  
 Beam: ..... 153 m  
 Draft: ..... 64.6 m  
 Mass: ..... 92,500 DWT  
 Crew ..... 344  
 Armament ..... 4 phaser banks (6 in 4YW refit)  
 ..... 2 photon torpedo tubes

Cruising speed: ..... warp 4.5  
 Maximum speed: ..... warp 5.2  
 (warp 6 after PB-32 upgrade)

Innovations:

- First large Star Fleet starship program in over two decades (31 vessels in 3 build groups, counting the *Nordenskjold* sub-class)
- First Star Fleet starship class since the *Bonnie Chance* to have a "thin disc" primary hull
- First Star Fleet starship class with an all-trititanium hull and frame
- First Star Fleet starship class built using the modular component construction system
- First Star Fleet starship class with transporter technology and duotronic computer systems

**SCHEMATICS:**

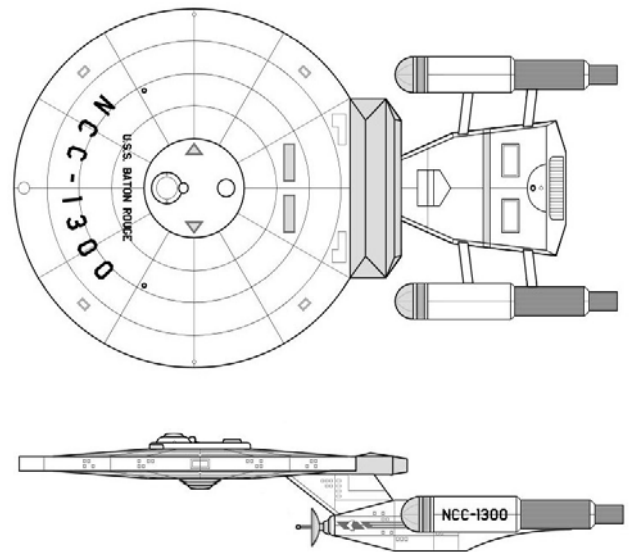

**BATON ROUGE** DESIGN BY RICK STERNBACH  
 SCHEMATICS BY NEALE DAVIDSON  
 MODEL SHOTS COURTESY OF LAUREN OLIVER AND STARSHIP MODELER

# **RANGER CLASS SURVEY CRUISER**

**SERVICE ENTRY DATE (OLD CALENDAR): 2205**

The *Ranger* class was a variation of the *Baton Rouge* concept intended to replace the *Mann* class in the survey cruiser role. For this purpose the secondary hull was moved up on top of the primary hull and the engines mounted underneath. This gave the *Ranger* the capability to change out its secondary hull as needed for special assignments, something that no other *Baton Rouge* era starship could do. This rarely happened because the science and survey facilities of a *Ranger* were usually more than adequate for the task. The idea would stick around, though, eventually leading to the development of the underslung container arrangement for the *Ptolemy* class transport/tug of the Class I Program.

The *Ranger* was one of only two *Baton Rouge* era starships classes that would be converted for the Class I Program. They saw service during the Four Years War and continued in the science and survey role for six more decades. For more information please consult *Federation Spaceflight Chronology Volume 10: The Class I Era*.

## **SPECIFICATIONS:**

- Length: ..... x m
- Beam: ..... x m
- Draft: ..... x m
- Mass: ..... X DWT
- Crew ..... 185
- Armament ..... 4 laser banks  
1 fusion torpedo tube
- Cruising speed: ..... Warp 4.5
- Maximum speed: ..... Warp 5.1

## **SCHEMATICS:**

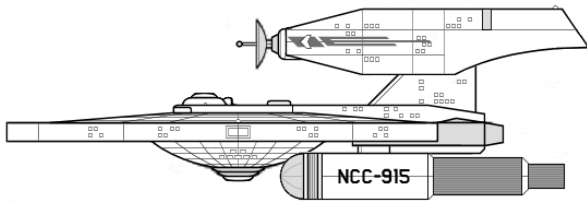

ORIGINAL *RANGER* DESIGN BY WALTER M. JEFFRIES  
*BATON ROUGE* GENERATION CONCEPT AND SCHEMATIC BY NEALE DAVIDSON

# **CONSTANT WARWICK CLASS LIGHT CRUISER**

**SERVICE ENTRY DATE (OLD CALENDAR): 2209**

*“Baton Rouge light”* is the best way to describe the *Constant Warwick* class. These had the same range as the *Baton Rouge* class and the same twin-engine configuration. The secondary hull, however, was replaced by an underslung “stump” housing its shuttle bay and other essential auxiliary systems. The intention for the *“Warwick”* class was to police Federation borders, thus relieving the *Baton Rouge* and other “heavy” Federation starship classes in this regard. A planned redesign to enlarge its secondary hull eventually evolved into the *Detroyat* class heavy destroyer. Only seven were built, with the remaining ships of the *Constant Warwick* class cancelled once the *Detroyat* class began construction.

The *Constant Warwick* has proven to be one of the most influential “light ship-of-the-line” designs of its generation. It directly inspired the *Detroyat* and *Marklin* class heavy destroyers, as well as the *Kearsarge* class light cruiser. Its “lines” can also be seen in the *Loknar* class frigate, the *Pompey* class destroyer, the uprated *Monoceros* class scout, and today’s perimeter action ship program (*Alert*, *Akyazi*, etc.).

## **SPECIFICATIONS:**

- Length: ..... x m
- Beam: ..... x m
- Draft: ..... x m
- Mass: ..... X DWT
- Crew ..... X
- Armament ..... 4 laser banks  
1 fusion torpedo tube
- Cruising speed: ..... Warp 4.5
- Maximum speed: ..... Warp 5.1

## **SCHEMATICS:**

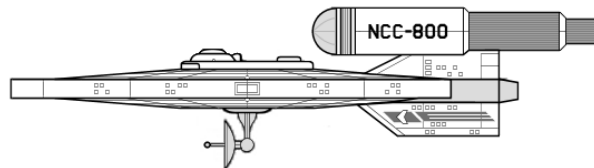

ORIGINAL *BATON ROUGE* DESIGN BY RICK STERNBACH  
*CONSTANT WARWICK* VARIATION BY NEALE DAVIDSON

# HALE CLASS SCOUT

**SERVICE ENTRY DATE (OLD CALENDAR): 2210**

The limitations of the *Lowell* design saw this produced as a quick-to-build stopgap scout until the *Cook* class could be approved for construction. Its small size and stealthy construction stood in stark contrast to the bloated, *Mann*-derived *Lowell*. In fact, it was so small that it could carry only a single, limited-range shuttlecraft with minimal repair and maintenance facilities.

The main advantage that the *Hale* had over the *Lowell*, apart from its size, was its fusion torpedo tube. This was never intended to launch torpedoes; instead, it was used for the firing of the new "probe missile." Based on converted fusion torpedo technology, probes were designed for stand-off survey, thus lessening the risk to any starship investigating an unusual event or phenomena. The *Hale* class scout was the first to use them in service. Within a few years room would be made in the torpedo magazines of all Star Fleet vessels for an array of probes for a variety of mission profiles.

All 25 vessels in the *Hale* class were decommissioned *en masse* in 2231 as part of Star Fleet's changeover to the Class I Program. Most were sold off for use in local system defense fleets.

## SPECIFICATIONS:

Length: .....	120 m
Beam: .....	114 m
Draft: .....	34.5 m
Mass: .....	9,000 DWT
Crew .....	65
Armament .....	1 laser bank
	1 fusion torpedo tube

Cruising speed: .....	warp 4.0
Maximum speed: .....	warp 5.0

Innovations:

- First Federation scout designed for the use of probes

## SCHEMATICS:

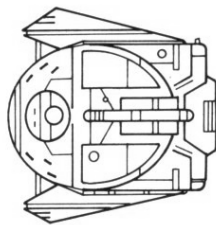

HALE DESIGN BY RICK STERNBACH

# ANTON CLASS CRUISER

**SERVICE ENTRY DATE (OLD CALENDAR): 2210**

The *Anton* represented an experiment in producing a "single hull" starship with all the performance and versatility of a Jeffries-derived design. This was accomplished by replacing the back half of a *Baton Rouge* saucer with a custom "modularized hull." An *Anton* could be reconfigured for a special role simply by putting it into dock, pulling the aft hull plates, then removing and adding modularized deck sections as needed. Its oversize dual shuttle bays could handle either specialty science craft or two full squadron of fighter shuttles, plus spares to boot. This gave the *Anton* the most mission potential of any design in its era.

The complexities involved in fabricating the *Anton's* special hull significantly delayed its entry into service. It was the largest of the *Baton Rouge* era starships, and the resources required to build it were considerable. In 2218 Star Fleet temporarily halted the program after the completion of only six ships due to a myriad of reasons, most particularly stress problems that had developed with its "splayed" angled warp engine pylons. In 2220 it ordered that the remaining twelve ships be built to a modified Class I design to resolve this and other related issues. This design would eventually evolve into the *Coventry* class frigate (and its counterpart, the *Miranda* class cruiser). All of the *Antons* that were already built were eventually returned to the yard and uprated to Class I specifications.

## SPECIFICATIONS:

Length: .....	185 m
Beam: .....	142 m
Draft: .....	48 m
Mass: .....	146,500 DWT
Crew .....	290
Armament .....	4 laser banks
	1 fusion torpedo tube

Cruising speed: .....	Warp 4.4
Maximum speed: .....	Warp 4.8

Innovations:

- First of the "modularized hull" Star Fleet starships

## SCHEMATICS:

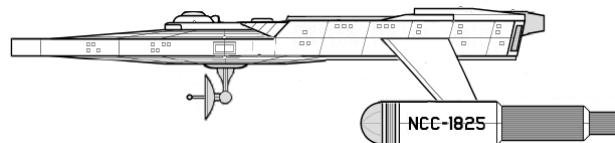

ORIGINAL ANTON DESIGN BY DANA KNUTSON  
BATON ROUGE GENERATION CONCEPT & SCHEMATIC BY RICHARD E. MANDEL

# BODE CLASS SCOUT

SERVICE ENTRY DATE (OLD CALENDAR): 2213

The *Bode* (considered by some as the “fourth” member of the “*Mann* generation”) was another attempt to overcome the design limitations of the *Lowell* class scout, but this time on a reconfigured hull. The overall design was the same; however, the *Bode* eschewed the elliptical disc of the *Lowell* in favor of a more utilitarian approach. Crew complement was also reduced, thanks largely to the installation of duotronic systems, in order to make way for a torpedo launch system. This gave the *Bode* class the probe-launching ability that the older *Lowell* lacked. Unique to the design was a special protective system fitted to the front of the warp engines. This helped to shield the delicate instrumentation of the *Bode’s* sensor suite from the effects of its own warp field.



All five ships in the *Bode* class were called out of retirement to serve during the Four Years War (2246-2250). During the war (and largely due to heavy Star Fleet losses) they were updated with modern systems and warp engines. The last of the rebuilt *Bode* class was not retired until 2254, once Star Fleet had enough new-build scouts so that its services were no longer required. None survived the scrapper’s torch.

### SPECIFICATIONS (2213):

Length:	191 m
Beam:	78.7 m
Draft:	31.0 m
Mass:	47,000 DWT
Crew	73
Armament	2 laser banks 1 fusion torpedo tube
Cruising speed:	Warp 4.0
Maximum speed:	Warp 4.9

### SCHEMATICS:

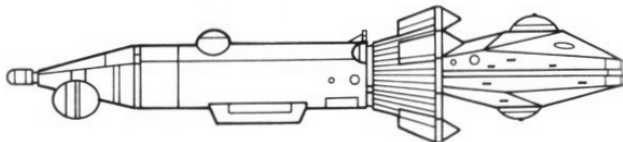

BODE DESIGN BY RICK STERNBACH  
VISUAL BY STEVE BARON

# DEROYAT CLASS HEAVY DESTROYER

SERVICE ENTRY DATE (OLD CALENDAR): 2214

The *Detroyat* was the last original design of the *Baton Rouge* generation to enter production. It started out as an attempt to address the operational deficiencies of the *Constant Warwick* class light cruiser. By the time the *Detroyat* began construction it had become something else: a fleet “superheavy” designed for military superiority and nothing else.

In today’s terminology the *Detroyat* would have been classified as a battlecruiser. The “heavy destroyer” label was cooked up in order to hide the true purpose of the class from the Federation Council. Many of its members were still leery of a starship designed for the sole purpose of battlefield performance. Their minds would change within a few short years once the Klingons made themselves known to the Federation.

Like the *Anton* class cruiser, the *Detroyat* class was halted in mid-production for conversion to Class I Program specifications. The process was actually easier for the existing *Detroyat* class starships than it was for the *Anton* class, since substantially less hull and frame conversion was required.

### SPECIFICATIONS:

Length:	x m
Beam:	x m
Draft:	x m
Mass:	X DWT
Crew	x
Armament	x
Cruising speed:	Warp 4.5
Maximum speed:	Warp 5.1

### SCHEMATIC:

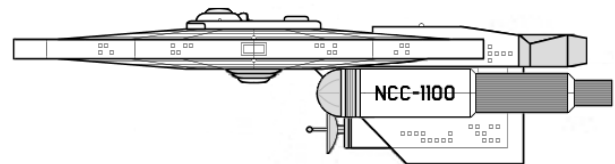

ORIGINAL DETROYAT DESIGN BY MICHAEL MORISSETTE  
BATON ROUGE GENERATION CONCEPT AND SCHEMATIC BY NEALE DAVIDSON



# NORDENSKJOLD CLASS EXPLORATORY CRUISER

**SERVICE ENTRY DATE (OLD CALENDAR): 2218**

The “*Old Norge*,” as her crews came to know her, was the first starship in the last and final build group of the original *Baton Rouge* class cruiser program. She and her five sister ships have a somewhat different configuration than do the earlier ships in the *Baton Rouge* class. Nevertheless, the six ships of the *Nordenskjold* class are often lumped in together with the *Baton Rouge* class in most fleet and historical discussions.

The design is essentially a *Baton Rouge* modified for the long-range surveyor role. For this purpose it was fitted with the same extensive “Zenith” sensor suite as the *Ranger* class. The torpedo tube was moved from the primary hull and mounted within the dorsal itself (a first for a Star Fleet design) so that the class would not lose the ability to operate probes. This necessitated a lengthening of the primary hull dorsal in order to provide the necessary clearance for the torpedo tube. Also, single engine pylons replaced the experimental “thin twin booms” of the *Baton Rouge*, which had proven in practice not to be as much of an advantage as had been hoped.

The *Nordenskjold* class all saw service as exploratory cruisers, supplementing the *Ranger* class. All saw service during the Four Years War (2246-2250). During the peace that followed, they would log more star hours than any other Star Fleet starship class of the period. Four survived the mass decommissioning of the *Baton Rouge* class in 2260 and played a major fleet support role in the short-lived Organian Incident of 2261. An attempt to convert two for use as auxiliary command cruisers had mixed results, and by 2280 all were more or less “fixed” at major fleet bases as flagships (in a reserve duty, albeit commissioned, status). Save for the odd emergency or two they would remain in this state until their final retirement in 2290.

The “*Old Norge*” is the only member of its class still in its original configuration that has yet to be sent to a Star Fleet storage depot or boneyard. It still remains in its berth at Starbase 1, which has been its home for the past 26 years. Efforts are underway to preserve her as museum ship but Star Fleet has yet to render a final decision on the matter.

**VISUAL:**

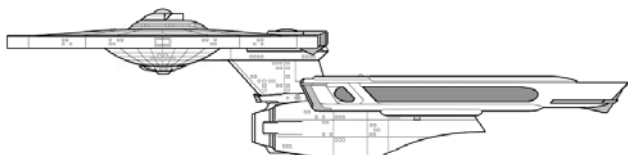

*USS Diaz* – command cruiser configuration (2290)

**SPECIFICATIONS (2218):**

Length: ..... 225.1 m  
 Beam: ..... 99.1 m  
 Draft: ..... 54.8 m  
 Mass: ..... 115,000 DWT  
 Crew ..... 280  
 Armament ..... 6 laser banks

Cruising speed: ..... warp 4.5  
 Maximum speed: ..... warp 5.1

**Innovations:**

- First Star Fleet starship class with a dorsal-mounted torpedo tube

**SCHEMATICS:**

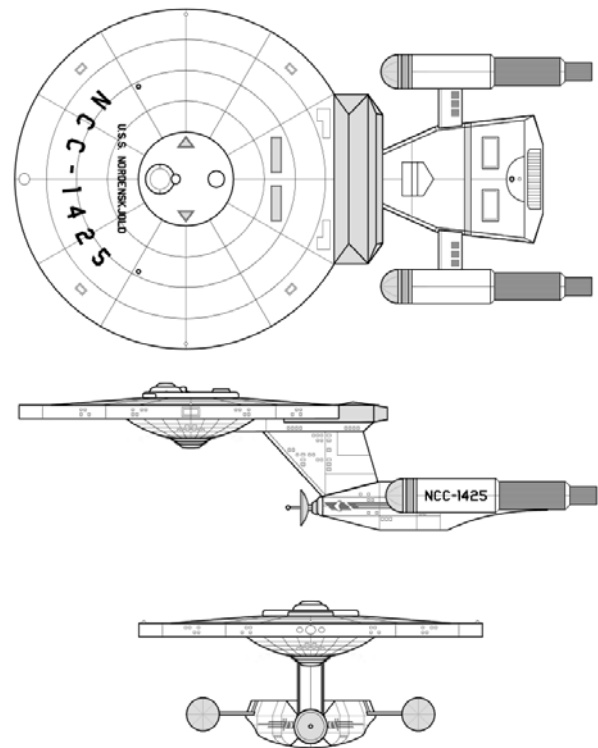

ORIGINAL *BATON ROUGE* DESIGN BY RICK STERNBACH  
*NORDENSKJOLD* VARIATION BY ARIDAS SOFIA  
 SCHEMATICS BY NEALE DAVIDSON

TMP-ERA COMMAND CRUISER VARIATION BY RICHARD E. MANDEL  
 BASED ON THE ARTWORK OF ARIDAS SOFIA  
 AND THE NOTES OF TIMO SALONIEMI  
 SCHEMATIC BY RICHARD E. MANDEL  
 DERIVED FROM THE WORK OF NEALE DAVIDSON

# DRAKE CLASS DESTROYER & COOK CLASS SCOUT

SERVICE ENTRY DATE (OLD CALENDAR): 2218

The *Drake* and *Cook* class starships were the forerunners of the *Saladin* and *Hermes* class starships of the Class I Program and shared identical roles. Their design configuration would have been deemed impossible mere decades before had it not been for the introduction of duotronic computer control systems. The “hijacking” of the design by the Class I Program ensured that only five of each were built before both classes were cancelled in 2225. One each of the *Drake* and *Cook* classes was relegated to the training role, while the others served as backup for regular Class I destroyers and scouts in the field. Both classes were retired in 2250 following the end of the Four Years War.

## SPECIFICATIONS:

- Length: ..... x m
- Beam: ..... x m
- Draft: ..... x m
- Mass: ..... X DWT
- Crew ..... 120
- Armament (*Cook*): ..... 1 laser banks
- Armament (*Drake*): ..... 4 laser banks  
1 fusion torpedo tube
- Cruising speed: ..... Warp 4.0
- Maximum speed: ..... Warp 4.8

## SCHEMATIC:

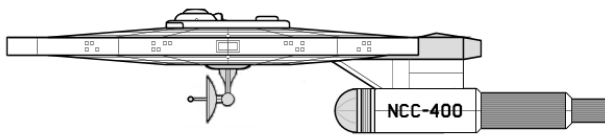

ORIGINAL *BATON ROUGE* DESIGN BY RICK STERNBACH  
DRAKE AND COOK VARIATIONS BY NEALE DAVIDSON

# INVINCIBLE CLASS DREADNOUGHT

SERVICE ENTRY DATE (OLD CALENDAR): N/A

This proposal, first submitted in 2217, was one of nine *Baton Rouge* era designs that were never built. It is included to demonstrate the origin of the dreadnought design. Its triple-engine configuration had been made possible by the duotronic revolution. Its purpose as a military superiority design is evident in its armament – nine FH-2 advanced laser banks (six on the saucer top and bottom, one on each side of the shuttle bay, and one “belly” mount on the secondary hull bottom) as well as dual forward-mounted fusion torpedo tubes.

The *Invincible* would have been the most powerful Star Fleet vessel of its era had it been approved. Instead, the design was passed on for several years and eventually put off for consideration with the later Class I Program. The first dreadnought would not enter service until after the Four Years War, over three decades after the design for the *Invincible* was submitted. One can only speculate how Star Fleet might have fared during the Four Years War had the *Invincible* and its brethren been available for the fight.

## SCHEMATIC:

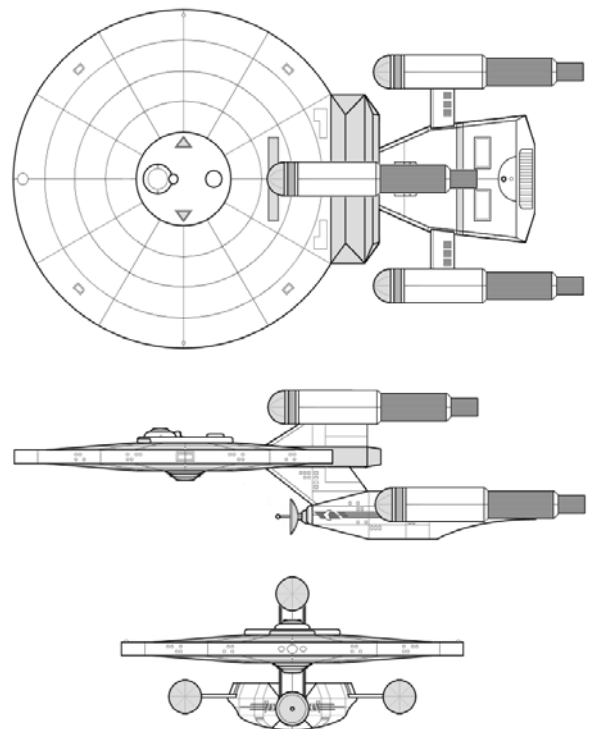

ORIGINAL *BATON ROUGE* DESIGN BY RICK STERNBACH  
BATON ROUGE GENERATION CONCEPT AND SCHEMATIC BY RICHARD E. MANDEL  
BASED ON THE WORK OF NEALE DAVIDSON

# CIVILIAN STARSHIPS

## ***PROVIDER* CLASS TUG**

**SERVICE ENTRY DATE (OLD CALENDAR): 2193**

The *Provider* class tug will forever be associated to students of Federation spacecraft history with the massive, 100-kilometer long warp superconvoys that became a common sight in the Federation during the early years of the 23<sup>rd</sup> century. In this time, before the capability for bulk mass transport of goods via special transporter beam conduits through space, these massive superconvoys were the primary means for transporting millions of metric tons in processed goods from one Federation system to another. Each superconvoy had eight *Provider* class tugs in an octagonal arrangement at its head, interlinking and synchronizing their warp fields in order to both pull and steer the superconvoy. "Booster squares" of four tugs staged between every 10-container segment assisted in this process. The superconvoy has since gone the way of the proverbial dinosaur; however, plenty of *Provider* class tugs still provide towing services in the civilian sector even today.

### **SPECIFICATIONS:**

Length: ..... 225 m  
Beam: ..... 220 m  
Draft: ..... 45.6 m  
Mass: ..... 72,500 DWT  
Crew ..... 66  
Armament ..... 4 laser banks

Towing speed (laden): .....warp 2.0  
Cruising speed (unladen): .....warp 3.5

### **VISUAL:**

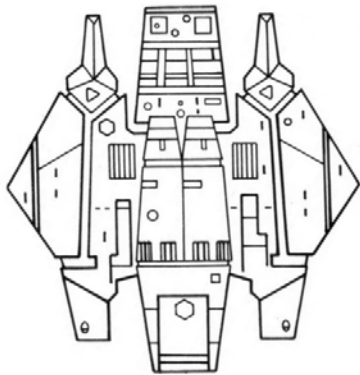

*PROVIDER* DESIGN BY RICK STERNBACH

## ***HUNTER* CLASS CORVETTE**

**SERVICE ENTRY DATE (OLD CALENDAR): 2201**

Entering service at the turn of the 23<sup>rd</sup> century, the *Hunter* class corvette was best known for its long association with Federation intersystem police forces. It was based on a military patrol ship design that had ultimately been rejected for the usual budgetary reasons. Overall, the *Hunter* class enjoyed an excellent reputation with its crews. It was unmatched in its class against all but dedicated military designs and Orion pirate vessels. The last *Hunter* was retired from police service in 2225; however, many can still be seen in use under private ownership.

### **SPECIFICATIONS:**

Length: ..... 85 m  
Beam: ..... 38 m  
Draft: ..... 43 m  
Mass: ..... 4125 DWT  
Crew ..... 6  
Armament ..... 4 laser banks

Cruising speed: .....warp 3.6  
Maximum speed: .....warp 4.8

### **VISUAL:**

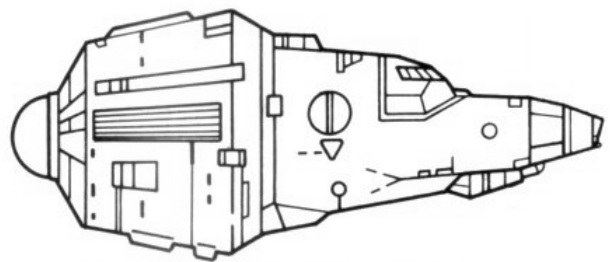

*HUNTER* DESIGN BY RICK STERNBACH

# MASTERS CLASS TUG

**SERVICE ENTRY DATE (OLD CALENDAR): 2208**

These were the standard civilian space tugs of the *Baton Rouge* era. They could be found everywhere, in every port of call, towing every conceivable kind of vessel or cargo.

The schematic shown here is the standard factory configuration. Most of their owners would customize them to suit their particular needs or tastes.

## SPECIFICATIONS:

Length: ..... 145 m  
Beam: ..... 118 m  
Draft: ..... 43 m  
Mass: ..... 22,000 DWT  
Crew ..... 20  
Armament ..... none

Towing speed (laden): ..... warp 2.5  
Cruising speed (unladen): ..... warp 3.8

## VISUAL:

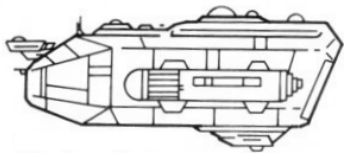

MASTERS DESIGN BY RICK STERNBACH

# CABOT CLASS TRAWLER

**SERVICE ENTRY DATE (OLD CALENDAR): 2211**

For almost three decades these were a common sight to remote Federation outposts and border stations. They were fast, had exceptional maneuverability, and were well armed for civilian vessels of the day. This was necessary for any starship operating near unexplored regions of space where hostiles might be lurking, such as the Romulan Neutral Zone or the unexplored regions beyond the Rigel sector. Many were lost supplying the Federation lines during Four Years War with the Klingon Empire (2246-2250). While the class officially ceased production in 2234, the surviving vessels continue to operate much as they always have in the far regions of Federation space.

## SPECIFICATIONS:

Length: ..... 161 m  
Beam: ..... 36 m  
Draft: ..... 28 m  
Mass: ..... 38,000 DWT  
Crew ..... 28  
Armament ..... 4 laser banks

Towing speed (laden): ..... warp 3.2  
Cruising speed (unladen): ..... warp 3.8

## VISUAL:

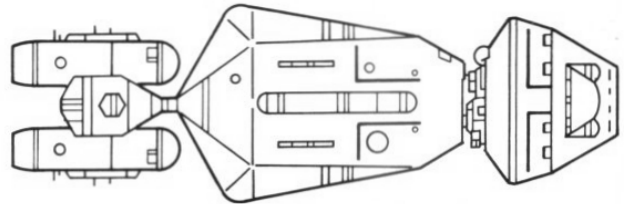

CABOT DESIGN BY RICK STERNBACH

# HERCULES CLASS TRANSPORT

SERVICE ENTRY DATE (OLD CALENDAR): 2210

The *Hercules* was the third design in the so-called “*Mann* generation” of starships. It is derived from the *Swiftsure* proposal, submitted by Star Fleet to the Federation Council in 2195 for a high-speed, single-nacelle, Warp 4 capable fleet transport/tug. Lack of funding plus an abundance of existing fleet transports caused the Council to refuse Star Fleet’s request for the class. Rather than let such a good design go to waste, however, Chiokis Starship Design used it for their effort in breaching the waters of the civilian starship market several years later. All of the features of its original Star Fleet proposal were present, plus the ability to handle a wide variety of civilian cargo containers in addition to Star Fleet standard *Watt*-type models. The fact that it was the first Warp 4 transport available on the market made it a quick seller, thus firmly establishing the beachhead Chiokis had sought in the civilian sector. Between 2210 and 2245 there were 153 *Hercules* class transports in five different configurations built for the civilian market. Almost all remain in service today.

## VISUAL:

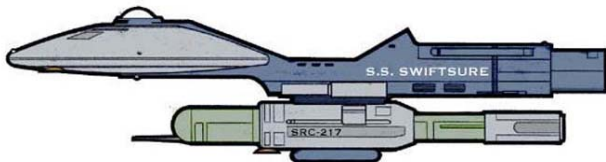

Original *Swiftsure* proposal (2195)

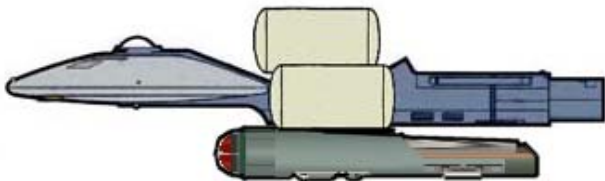

The civilian *Hercules* model (2210)

SWIFTSURE DESIGN BY PAUL ALEXANDER  
ORIGINAL SCHEMATIC BY WARPED9



*Baton Rouge* era Class J cargo ship



The *Vanguard* Project – a unbuilt *Baton Rouge* era design proposal based on the 2150s era NX-Project

The complete list of starships classes that were authorized for the *Baton Rouge* generation of starships is as follows:

- Baton Rouge* class heavy cruiser
- Ranger* class survey cruiser
- Constant Warwick* class light cruiser
- Anton* class cruiser
- Drake* class destroyer
- Cook* class scout
- Detroyat* class heavy destroyer

(*Nordenskjold* is considered part of the *Baton Rouge* class for purposes of this list)

Authorized designs reallocated to the Class I Program include:

- Marklin* class heavy destroyer

Unauthorized but proposed designs include:

- Invincible* class dreadnought
- Liberty* class transport/tug
- Titan* class shuttlecarrier
- Vanguard* class frigate
- Carolina* class frigate (a *Vanguard* competitor)
- Hdeljas* class assault ship
- Valley Forge* class battle cruiser

# TERRAN EXPLORATIONS

## HYDRA II

Hydra II (UFC 82943 III) is a relatively young planet, cosmically speaking. It is estimated to be only 3 billion or so years old on the cosmic scale. It is also the first of only two pelagic planets ever discovered within Federation space. Hydra II was the first in 2202, and Argo was the second in 2264.

Hydra II is actually the third of three planets orbiting a single G-type star. It was named Hydra II by early Terran astronomers because their instruments could only detect the two outermost planets in the system at the time planets were first detected. The innermost planet UFC 82943 I, orbits so close to its parent star that it is almost within range of being engulfed by Hydra. There is evidence within Hydra's spectral readings that the system originally contained more planets and that the star engulfed them as it expanded. Hydra apparently ended its expansion just over a million years ago, leaving only three planets in its solar system. Its expansion put the outermost planet with its new habitable zone, setting in motion the chain of events that made Hydra II the planet it is today.

The native intelligent lifeforms are known as the Hydrans. They were the first aquatic humanoids ever encountered by the Federation. They are naturally very friendly and inquisitive, and first contact for both Hydrans and humans was a pleasant experience. Special equipment is required to descend to their home, the great Coral Castles at the bottom of Hydra's oceans, but the trip is well worth the price. Both the Coral Castles and the spectacle of the sacred Hydran Water Ballet (a ritual they permit visitors to witness) are sights almost beyond compare for both their beauty and elegance.

Visitors to Hydra are strongly advised to keep to those few areas where a Federation presence is established for their own safety, such as the Lonely Isles. It is easy for casual tourists or inexperienced navigators to get lost in Hydra's endless oceans. What Hydra does have is an abundance of water, both on its surface and in its atmosphere. It has so much water that in certain areas of the planet it is hard to find the horizon due to the presence of abundant ocean fogs. The Lonely Isles are a group of seven islands that are also the major surface port-of-call. They are one of the few land masses that rise above Hydra's vast oceans; hence the rather romantic name. It should be noted that the closest landform to the Lonely Isles is Poseidia, a solitary island where the first landing party from the *USS Poseidon* set down back in 2202. In straight-line travel it is approximately 4300 kilometers from the Lonely Isles.



### SPECIFICATIONS:

System star: UFC 82943 (*Hydra*)

Distance from system star ..... 348 million km  
Period of revolution (Terran measure) ..... 28.6 hours  
Period of orbit (Terran measure) ..... 444.6 days  
Mass .....  $x \times 10^{24}$  kg  
Diameter ..... x km  
Axial inclination ..... 24.6°  
Average surface temperature ..... 19° C

Satellites ..... none  
Planetary classification ..... N  
Richter Scale cultural rating ..... C-

Indigenous culture ..... humanoid  
*(homo aquan hydrus)*  
Additional cultures ..... humanoid

#### Major surface features:

The Lonely Isles (main Federation surface port)  
Poseidia  
The Popcorn Archipelago  
Roger's Rock  
The Duggan Sea Ranches  
The Coral Castles of Hydra

# HISTORICAL ARTICLES

---

## NEW STARSHIP EXCEEDS WARP 4

SIR REGINALD BARCLAY, GUEST COMMENTATOR  
*JAYNZ DEFENSE WEEKLY* – 27 MAY 2192

---

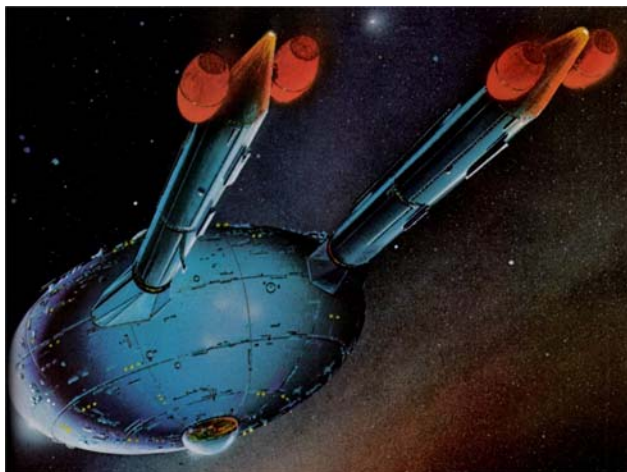

The future of Star Fleet appears to lie in one of the oddest-looking craft ever to sail out of spacedock. The *Mann*, the latest in a series of general-purpose survey cruisers mandated by the Federation Council, has seemingly done the impossible. It has sustained a speed of Warp 4 without going to pieces. Not only has it done this once, it has done it repeatedly. And how, may you ask, that a starship that looks like it would be more at home wallowing in a mudbath accomplish such an amazing feat? By its frame, we're told, made from a new wonder metal they call trititanium. One can only hope that the minds behind this breakthrough can find a way to work this metal into a more aesthetically pleasing shape. Otherwise, the very look of our starships will frighten away any potential threats to Federation peace.

## BACK-TO-EARTH MOVEMENT PROCLAIMED

*BENECIA HERALD* – 16 AUGUST 2194

---



Benecia Colony

A dissident group calling itself the Back-to-Earth Movement held its first public meeting today at the Benecia Community Hall. Thirty-nine beings were in attendance. Dr. Raleigh Mitnick of the space city *Tsiolkovskygrad* and Symmetrist Stlak of Vulcan were the guest speakers. The group calls for the dissolution of “the imperialist Federation government.” Although primarily Terro-centric, the group also encourages beings of other worlds to leave the Federation and resume management of their own affairs, forming common ground between Back-to-Earth and the Vulcan Symmetrist Party. The meeting was carried out in a peaceable manner despite protests from local pro-Federation activists.

# BIRTH OF THE SUPERCONVOY

UFP INFONET – 15 MAY 2197

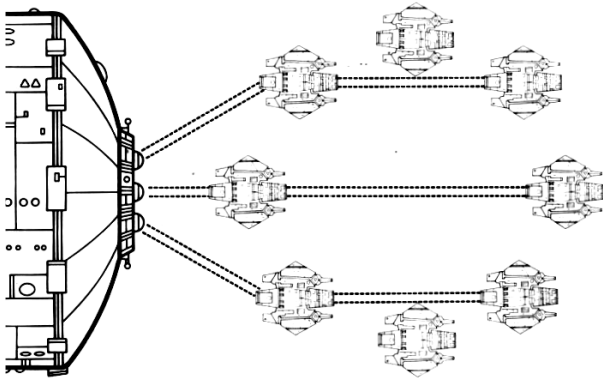

What to some is impossible is to this man a challenge waiting to be solved. His name is Alberto Sabella, chief engineer of the space tug *Muletrain*, who is the genius behind the new superconvoy concept.

“They need to move lotsa goods real fast, they say. Only problem? No way to pull it. You canna build a space tug big enough to pull a cargo can the size of a colony. So me, I look at the problem. I think of my little space tug, my *Muletrain*, my tiny bambino, and it hits me. If we canna pull it with *one* mule, then why not a *pack* of mules? Just like they did in the old days. Spread the load and pull more. If a mule could do it, then my *Muletrain* and his brothers, they can do it, too.”

# LARGEST SPACELIFT IN HISTORY

FEDERATION NEWSFLASH – 4 DECEMBER 2200



This is Gina Jameson for *Federation Newsflash*. I'm standing in the shuttle bay of the Star Fleet cruiser *USS Endurance*, looking out at the view behind the ship. Below us recedes the surface of Bayard's Planet, from which every single person, pet, or other living being has been removed. Too close for comfort is an angry wave of gas and light that has just passed the system star and is on its way towards us. The *Endurance* can outrun it and is even now getting up to warp speed so it can jump away. Still, this is as close as I ever want to come to death. It's hard to believe that something so beautiful as the Phi Puma shockwave could be so deadly.

Most other worlds in the Federation are capable of dealing with this shockwave by virtue of their natural radiation belts and proper precautions by their residents. Bayard's Planet has no such belt, leaving it wide open to the devastating effects of the shockwave's intense energy and radiation. Admiral Nelson, commander of the *Endurance* and overall leader of the evacuation effort, is to be commended for making sure that no stone was left unturned in the total evacuation of Bayard's Planet. This is a feat that will go down in the history books, thanks to his dedication and leadership.



## DEATH OF A LEGEND

UFP INFONET – 17 SEPTEMBER 2204

---



Earlier today, Chiokis starship designer Mark Chausser was killed in a shuttlecar accident just outside of Paris, France. Chausser was hit head-on by a drunken driver and died instantly.

"It's a tragic loss," said Franz Joseph IV, Chausser's second at Chiokis. "He was a visionary ahead of his time. He saw the path that starships needed to go and fought with all his skill to make them go there. I know that I and everybody at both Chiokis and Star Fleet are going to miss him."

The son of an itinerant trader, Chausser was raised on at least a dozen different worlds. As a youth, he got to see more of the Federation than most beings do in their lifetime. Eschewing his father's profession, he settled down in the Earth colony at Tellar and quickly made a name for himself in the planetary shipyards. By his late twenties he had earned a nomination to the University of Oreas on Alpha Centauri, where he graduated *summa cum laude*. Upon graduation he was drafted by Chiokis Starship Design of Andor, for whom he would work the rest of his life.

Chausser's main claim to fame was in reviving the works of starship design pioneer W. M. Jeffries, the genius behind the rebuilding of the *Bonaventure*. Chausser staunchly argued that the technology had finally caught up with the vision of Jeffries and did all that he could to move Star Fleet in that direction. His two main contributions were in pioneering the use of trititanium for starship construction and in producing the first workable "thin disk" primary hull saucer for Federation starships. These and other Chausser design concepts are embodied in the *Baton Rouge* and *Ranger* class starships, which will be joining the fleet next year.

Chausser is survived by a younger brother, Gregory Chausser, and a younger sister, the lady Anne of Tellar. His body is being returned to the family home on Tellar for services and burial.

## BATON ROUGE MARKS

## NEW STARSHIP ERA

UFP INFONET – 21 JUNE 2205

---



The *USS Baton Rouge* (NCC-1300) leaving drydock

One of the most emotionally charged construction "races" of modern times ended today with Star Fleet's newest cruiser, the *USS Baton Rouge* being launched just over seven hours ahead of the survey cruiser *USS Ranger*. As such the *Baton Rouge* is officially the first vessel in Star Fleet's newest generation of starships to join the fleet.

"This ... this is an incredible moment," said Franz Joseph IV, senior Chiokis engineer and one of the minds behind these new vessels. "I just wish Mark were here to see this. It was his baby. It was so beautiful, watching it slowly slip out of drydock like a baby chick coming out of its shell. *Ranger* will be joining her in a few hours, and I'm not going to miss that launch, either. It's the dawn of a new starship age, folks."

Joseph was referring to his late mentor Mark Chausser, the man who invented the trititanium starship frame and the lead designer of both the *Baton Rouge* and *Ranger*. Chausser was tragically killed in a shuttlecar accident last year. The starships that he brought to life are perhaps the greatest tribute in his behalf.

The *USS Baton Rouge*, under the command of Captain William van Anling, will be undergoing a shakedown cruise to Tau Ceti. From there the new starship will proceed to Andor for additional evaluation and check-out at Chiokis company headquarters. The *USS Ranger*, under the command of Captain Maximillian Reinhardt, will be taking its shakedown cruise to Vulcan once it launches.

# FIRST MATERIALIZER TEST SUCCESSFUL

UFP INFONET – 07 JULY 2208



“Let’s beam over.” Those words will soon become part of lexicon of Federation citizens everywhere. Today, high in orbit above Terra, the final verification test of the materializer was successfully completed. Science Officer Jordan Winslow of the *USS Moscow* beamed over from his own ship to the nearby *USS Tehran* without loss of life and with all of his body parts and organs 100% intact. Materializers will now be added to Star Fleet’s formidable repertoire of starship support systems, as well as promising to change travels in civilian life.

“This could be the most significant breakthrough for the travel industry since the invention of warp drive,” noted Dr. Fredrick Ravishol, UFP Infonet science adviser. “No more mucking about in sublight shuttlecraft, or magtrams, or aircars or such. Once materializers are in place you can just beam from one place to another in a fraction of a second. Look at what materializers are doing already for the transport of bulk goods. It’s driving down the cost of goods and services, since they’re cheaper to beam than to ship. Imagine going from Terra to Vulcan for the price of a magtram ride to San Francisco. It could very well happen within our lifetime.”

As optimistic as Dr. Ravishol’s predictions may be, however, materializers still have a long way to go in order to win public acceptance. The recent court battle over the ethics involved in converting a being from matter to energy and back again has caused heated debate within Federation religious and political movements. Many believe that the soul is lost at the moment of transit and thus have come out with statements advocating their followers not to use materializers. “Oh, that’s poppycock,” Dr. Ravishol retorts. “Idiots choosing superstition over reality. They said the same thing about cameras back in the 19<sup>th</sup> century and it isn’t any more true than it is now. Materializers are perfectly safe. I haven’t seen any lost souls drifting around yet.”

# A NEW TYPE OF TORPEDO

STAR FLEET NEWS – 06 MARCH 2212



Say goodbye to fusion torpedoes. A new secondary weapons system, the photon torpedo, promises to provide even more “bang for the buck” than Star Fleet’s old standby.

The basis for the two systems is the same: an unstable mixture of elements held at just below critical mass until it impacts its target. The force of the impact combines the mixture, resulting in the explosion. The material uses to make the “bang,” however, is quite different. Fusion torpedos are in essence a rocket-propelled, multimegaton thermonuclear warhead. A photon torpedo derives its explosion from a matter-antimatter mixture. Loraxial Corporation of Andor, the inventors of the fusion torpedo, are also the ones behind the development of the photon torpedo.

“The biggest problem we had was in developing a warhead-sized, low-power containment field,” notes Priscilla Fredric. She is the genius behind Star Fleet’s new weapon. “We obviously couldn’t use a standard warp engine containment bottle because that was too big. This is the first time we’ve been able to make one small enough for warhead use.” Fredric was quick to point out that the potential works both ways. “This isn’t just limited to weapons development, you know. Within a few decades you’re going to start seeing warp engines with matter-antimatter containment bottles the size of, say, a large drink dispenser.”

Both Star Fleet and Loraxial are in the final round of testing for the new weapon. A Star Fleet spokesman says that Star Fleet Command is looking forward to seeing photon torpedoes enter service within the next five years.

# THE CLASS I PROGRAM

*THE ALAN RIDDICK SHOW*

TERRAN UNITED NEWS NETWORK – 4 JULY 2218

---



*USS Constellation (NCC-1017)*

RIDDICK: Today we're taking a look at one of the most expensive starships ever built to join Star Fleet – or rejoin, to be more accurate. At one time she was the *Constellation*, a *Horizon* class heavy cruiser and the last of her class to be built. Today, though, she's something else – a vessel the likes of which not even the mighty new *Baton Rouges* can touch. She looks like nothing else in the fleet ... and, hopefully, to some, she's only the beginning. The *Constellation* returns to active duty today along with the similarly refitted *Republic* in a publicity move Star Fleet hopes will gain popular and political support for its new Class I Starship Program.

With us today is Franz Joseph IV, the young protégé of the late starship designer Mark Chausser and now head of Chiokis Starship Design. Joseph is the man responsible for the *Constellation* and chief designer for the Class I Program. I want to thank Mr. Joseph for being willing to walk into the lion's den with us, as it were, and come on the show today. He is quite passionate about Project Starship, which is the reason why I wanted him here. Welcome to the show, Mr. Joseph.

JOSEPH: My pleasure.

RIDDICK: I'm going to cut right to the chase. What are we doing spending money for yet another new starship program when we've already got one underway?

JOSEPH: Have you been to the Rigel sector lately?

RIDDICK: I'm the host, I ask the questions.

JOSEPH: That's my answer.

RIDDICK: That's a question, not an answer.

JOSEPH: If you're aware of what's been happening in the Rigel sector the past few years then you should know why we've been pushing the Class I Program.

RIDDICK: But surely Star Fleet has enough starships already! I mean – come on, you've had almost two dozen different new classes in the past quarter-century.

JOSEPH: Not all of which worked out---

RIDDICK: --and that's my point. Why are we wasting citizen's credits again? I thought these new *Baton Rouge* starships were supposed to fix all of Star Fleet's problems.

JOSEPH: They're doing quite an excellent job as we speak—

RIDDICK: --which again leads me back to my point: why are we wasting money on new starships we don't need?

JOSEPH: Are you ever going to let me finish a sentence?

RIDDICK: I'm sorry. What was it you wanted to say?

JOSEPH: (sigh) We had to make certain compromises with the *Baton Rouge* in order to win Federation Council support. In short, we didn't get the starship we wanted.

RIDDICK: Seems to be doing pretty good for something that's not perfect. That's what you said, isn't it?

JOSEPH: Even so, it could have been better. We had to cut corners on the secondary hull design, on the impulse deck---

RIDDICK: Are you saying that we've got another *Tritium* on our hands?

JOSEPH: That was uncalled for, sir. *Constellation* is *no Tritium*. *Tritium* failed its first space trial.

RIDDICK: In a rather spectacular fashion, as I recall.

JOSEPH: The *Baton Rouge*, *Ranger*, and the rest of the new classes have all passed their space trials with flying colors.

RIDDICK: So if you had to cut corners and wound up with a less-than-perfect batch of starships, then why are they doing so well?

JOSEPH: Lots of reasons. The new trititanium frames are the chief reason. We couldn't go Warp 4 without them.

RIDDICK: That I'll grant you.

JOSEPH: Thank you. Adopting the Jeffries design philosophy, with the saucer-and-nacelle approach, has dramatically improved warp performance as—

RIDDICK: Whoa, whoa, whoa, you're starting to use those ten-credit words on me. I'm not a starship designer and neither is my audience.

JOSEPH: It's not built like a flying box, like past starships, so it moves faster and takes corners better.

RIDDICK: I see. What about the new weapons the *Constellation* is carrying?

JOSEPH: The new warp engines that Star Fleet is using have a lot more power than the old ones. The laser banks we've installed on the *Constellation* are the same that Star Fleet was putting on its starbases just five years ago.

RIDDICK: That's a helluva lot of juice. I'd hate to be the space pirate to tangle with a ship like that.

JOSEPH: And that's not all. She's got twin photon torpedo tubes, too, and I'm sure you aware of what those can do.

RIDDICK: Well, I'm no military expert, but I hear those things are pretty powerful.

JOSEPH: Which brings *me* to *my* point. The generation of starships that's following the *Baton Rouge* are as big a jump above them as they were over everything that was built after the Romulan War. When you look at the *Constellation* you're looking at the future of Star Fleet.

RIDDICK: So we're going back to a purely military Star Fleet, then, I take it? I thought the Federation Council outlawed that.

JOSEPH: (sigh) *Constellation* is not just a warship.

RIDDICK: I wouldn't have guessed, based on the way you were talking, but go ahead.

JOSEPH: With the new design we've been able to significantly increase *Constellation's* science and survey capability. She's not just a fighter, Alan. She's also an explorer. She's got at least the same science capability as a *Ranger* class survey cruiser, and that's a lot. She's got heavy cruiser firepower, yes, but its there only if it's needed.

RIDDICK: Well, I know some Star Fleet captains with some pretty itchy trigger fingers. Just ask the Klingons.

JOSEPH: Ah, so you *do* know what's happening out beyond Rigel.

RIDDICK: Whether I do or not makes no difference. Looks to me like you've built a warship, not a deep space explorer. We're in a time of *peace*, Mr. Joseph. The last thing we need is a warp-powered battlestation to fight another war.

JOSEPH: As I recall, we're not the ones who picked a fight with the Klingons, but that's not why—

RIDDICK: --oh?! That's not what they say.

JOSEPH: (sigh) As I was saying, I'm not here to discuss the Klingons. I'm here to discuss the Class I Program.

RIDDICK: But isn't that what the Class I Program is all about? Build a better warship and the Klingons will come knocking at your door?

JOSEPH: I'm a starship designer, not a soldier. I think Star Fleet can answer that question for you.

RIDDICK: Well, tell me this. With all of this weaponry at its disposal, do you think there's anything the Klingons have that could take out the *Constellation*?

JOSEPH: I honestly can't say. I can tell you this, though. It's going to take a lot to knock out the *Constellation* and her crew. Star Fleet will do what they can to avoid that fight, like it always does, but if it comes right down to it, she'll go down fighting with every inch of life left in her frame. *That* is something you can count on, Mr. Riddick.

RIDDICK: I can't argue with that. Thank you for your time, Mr. Joseph.

**to be continued ...**

# ACKNOWLEDGEMENTS

## VOLUME 09: 2190-2220

### AUTHOR'S COMMENTS:

---

Please note that starting with this volume there will be no separate Schematics section. That's because pictures and stats for *all* starships from the timeline are covered in the Starships section. Besides, there's SO MANY in this issue! Seems like I'm getting more and more significant starship classes the closer we get to "our" time ....

---

One of the first things that *FSC* readers will notice is that my interpretation of data from the old *SFC* in the Prime One timeline happens a lot faster than it does in Prime Zero (Dixon's Fandom Timeline). That's because the date's are off, and Dixon talks about this problem at length in his work. Based on what I've been able to deduce, his resynching of the *SFC* dates would work given an *Enterprise* launch date of 2245. There's just one problem with that assumption. It's wrong, and just about everyone who's reading this knows why. If you don't, go read my post in the FRS Forums about "That dratted *Enterprise* launch date ...." I have accordingly resynched the *SFC* data from Prime Zero in order to adjust for a corrected "early" *Enterprise* launch date of 2223. If you still think I'm off my nut then you need to get the *Star Trek Animated* series and watch "The Counter-Clock Incident" sometime. You'll get your answers within the first five minutes of the episode.

---

My apologies to both Aridas Sofia and Neale Davidson for my editing efforts in combining your differing views on this key period in Federation spacecraft history. This was based solely on my interpretation of Star Fleet hull number sequences (the NCCs) given my military experience and my understanding of U.S. Navy hull number assignments over the years. The decision I had to make was to either "short" the *Archon* class (Sofia) by several ships per Timo's notes, thus freeing up the *Republic* to be a *Ranger* class starship per its hull number (Davidson), or eliminate the *Archon* class entirely. I didn't want to do that because I already owe Aridas way too much for letting me use his materials and kitbashing his schematics. Aridas is going to pretty much get his way in the next volume, though, insofar as the timeline and the development of the Class I Program starships go. Fans of Aridas might have already guessed this from the revised *Baton Rouge* era timeline presented here. Those of you interested in finding out exactly why should visit the Timeline Talk Forum at the Federation Reference Series Online and look for the topic, "That dratted *Enterprise* launch date ...."

---

Yes, I KNOW that the picture of the "prototype" *Connie* in drydock is actually that of the TOS-era *Enterprise*! To be honest, though, I couldn't find a picture of the pilot (pre-TOS) *Enterprise* in drydock, else I would have used that instead. If anybody knows where I can find one, I'll gladly correct this known error on my part.

---

My apologies to Aridas Sofia in particular for kitbashing his beautiful *Horizon* and *Nordenskjold* drawings to show the evolution of the *Constellation*. I had already done something similar in the FRS forums trying to see how one might arrive at Class I heavy cruiser from the *Horizon*. I've since revised my concepts a bit and they show in the kitbashed drawings in this volume. Hopefully I'm not too far off from the "truth" --- provided he can forgive me for changing to which starship class the *Republic* belongs. The only reason I did this is because of the use of a *Baton Rouge* era *Republic* in a licensed work (however inaccurate the story might have been). It also gave me a chance to play a *Baton Rouge* derived Class I prototype (Sternbach - *Republic*) against a *Horizon* derived Class I prototype (Sofia - *Constellation*). Of course, we *know* whose design won, don't we? (grin) There are those "old school" fans who are not overly fond of the *Baton Rouge*, so this is my way of vicariously duking it out between the two for these folks.

---

I took the liberty of retconning Michael Morissette's *Detroyat* class heavy destroyer per the suggestions of Neale Davidson in order that it become part of the *Baton Rouge* generation of starships. The same goes for Dana Knutson's *Anton* class cruiser, again per Davidson's suggestions. I agree with Davidson in that these were both probably older designs that were upgraded once the Class I program came into being. This actually makes sense for the *Detroyat* given the way it was designed by Morissette. The angular lines of its secondary hull compare nicely to those of the *Baton Rouge*'s own, and an error in Morissette's dating obscured the fact that he intended the *Detroyat* to be launched during this era. That's the main reason why the adjusted build date is so late for a *Baton Rouge* era vessel. This way, the bulk of the class can be upgraded to Class I while they're still under construction. Including the *Anton* at this point also helps smooth out the development timeline of the starship *Reliant* (*STAR TREK II: The Wrath of Khan*). Paramount apparently decided to ignore FASA's *Anton* in authorizing a TOS-era *Miranda* precursor a while back, which has since popped up in several officially licensed works. I didn't want to lose the *Anton* because, to be honest, it was published long before they started using the term "*Miranda* class" on screen in TNG. This

seemed as good a way of keeping the *Anton* in the starship development timeline as any.

---

Having three different space “objects,” each of which is the *Kepler*/*Kepler* class, can be rather confusing. I know it confused some of my reviewers. In this case my sources are the guilty culprits. The *Kepler* class space probes come from Goldstein and Sternbach’s old *Space Flight Chronology*. The *Kepler* class deep space station comes from *Jaynz’ Starfleet Reference Series #2*. The *Kepler* class transport/tug (in Volume 10) comes from Franz Joseph Schnaubelt’s *Star Fleet Technical Manual*. Confused enough? Let me assure you, based on my own personal USNA experience, that this is the sort of thing upperclassmen love to use in trying to trip up plebes as part of their training. Trust me. That’s why I let it ride instead of trying to find some way to fix the names to make more sense. Kinda like naming both submarines and battleships after states in our time. We’ll see this problem again with the *Ranger* in future volujmes.

---

The *Drake* class destroyer is the *Baton Rouge* equivalent of the Class I *Saladin*, just as Neale’s *Cook* class scout is the predecessor of the Class I *Hermes*. The lead ship is named for English sea warrior Sir Francis Drake.

---

My apologies for *still* not having stats for many of the ships in the *Baton Rouge* generation. I intend to fix this in the next major revision once I find the time.

---

The *Hercules (Swiftsure)* class transport comes from the cover art of the later books in *The Best of Trek* paperback series by Walter Irwin and G.B. Love. The starship in question is taken from the actual cover art from *TBoT #10* by Paul Alexander. The lines of the *Hercules* saucer both as drawn in the schematic and in the original artwork suggest a correlation to the “*Mann* generation” of starships. The only liberty I took with Warped9’s original schematic was to “fit” it with a single “surplus” PB-17 engine. These were ostensibly left over from the later *Horizon* program and hopefully brings it closer to the *TREK* norm.

Regards,

-- Richard

---

Not too many in-jokes and asides this time, but here they are:

- 1) The image of starship designer Mark Chausser is that of Professor E. J. Parsafoot (Charlie Dell) from the old Saturday morning sci-fi serial *Jason of Star Command*. Filmation did both *Jason* and the animated *Star Trek*, with the music of the latter being recycled for the former. Besides, as cheesy as it was it’s still a personal favorite of mine ... and I always did like the Starfire.
- 2) The “Roddenberry Twin-Nacelle Rule” was cooked up by the Great Bird himself as a slap in the face to Franz Joseph Schnaubelt and the old *Star Fleet Technical Manual*. I never really figured out why, after its “canonization” on screen in the first three *TREK* feature films, the Great Bird suddenly decided it wasn’t canon and that starships always had to have two engines. Probably something to do with the *Star Fleet Battles* license, no doubt. Of course, we *know* how long that imperial edict lasted (cough-*Deep Space Nine* -cough-cough). It’s my way of poking fun at a spiteful little “rule” that never should have existed in the first place.
- 3) Franz Joseph IV’s “doodle” that leads to the development of the Class I heavy cruiser is in fact a profile view of Bernd Schneider’s *Asia* class survey cruiser. It’s one of my favorite fandom designs, and Schneider’s Ex Astris Scienta website has been a big help in developing the FSC. I couldn’t include the *Asia* outright due to class conflicts and permission issues, but I slipped this little aside in anyway as my way of saying, “Thanks.”
- 4) “Captain Maximillian Reinhardt” is a reference to the Walt Disney sci-feature film *The Black Hole*.
- 5) “Dr. Fredrick Ravishol” is a rather blatant reference to Dr. Ravishol from the classic *Battlestar Galactica* episode, “Gun on Ice Planet Zero.”

## SPECIAL THANKS TO:

---

Jason Bogguss (Star Fleet Network)  
Stan and Fred Goldstein  
Bernard Guignard  
Neale Davidson (Pixel Sagas)  
Steve Miller  
Masao Ozazaki (Star Fleet Museum)  
Timo Saloniemi  
Aridas Sofia (Federation Reference Series Online)  
Rick Sternbach

## IMAGE SOURCES:

---

3D Gladiators  
Randy Asplund  
Atolm  
Steve Baron (Vintage Starships)  
Battleclinic.com  
Don Christansen  
Neale Davidson (Pixel Sagas)  
Harry Doddema (Titan Fleet Yards)  
Federation Frontiers  
Lawrence Miller  
Michael Newlyn  
Lauren Oliver (Starship Modeler)  
Bernd Schneider (Ex Astris Scienta)  
Aridas Sofia (Federation Reference Series Online)  
Starship Art  
The TrekBBS  
Wikipedia

## YOUR HELP IS NEEDED!

---

I'm looking for some schematic and 3D/mesh artists to do spacecraft for future issues of the *Federation Spaceflight Chronology*. Want to contribute? Then drop me a line!

[rtroudede@cox.net](mailto:rtroudede@cox.net)

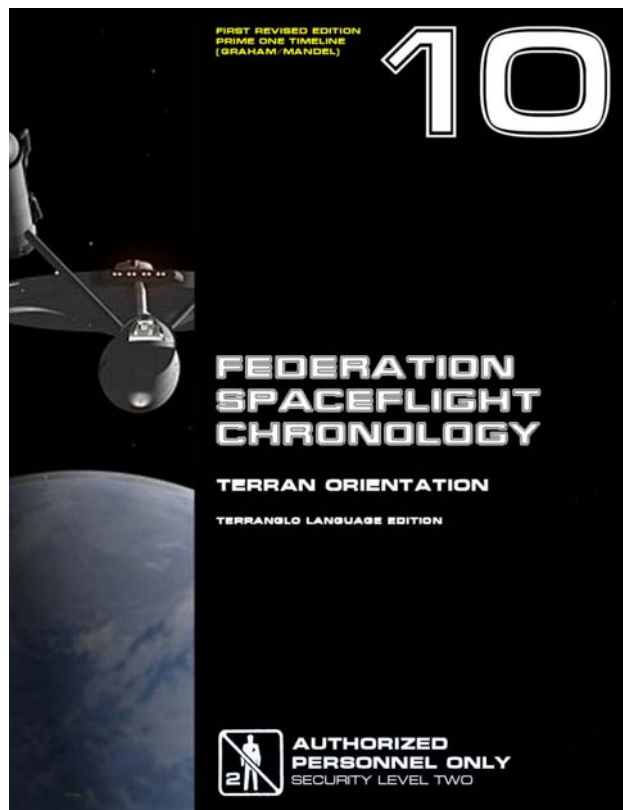

coming soon

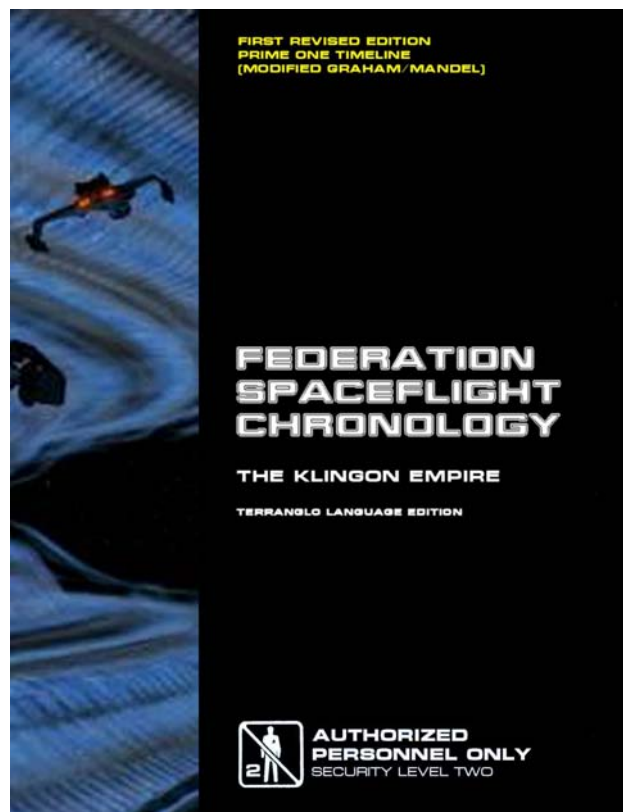

also available



