

**FIRST REVISED EDITION
PRIME ONE TIMELINE
[MODIFIED GRAHAM/MANDEL]**

8

FEDERATION SPACEFLIGHT CHRONOLOGY

TERRAN ORIENTATION

TERRANGOLO LANGUAGE EDITION



**AUTHORIZED
PERSONNEL ONLY**
SECURITY LEVEL TWO

Original texts and manuscript concept copyright © 2007 by Richard E. Mandel

STAR TREK, its on-screen derivatives, and all associated materials are the property of Paramount Pictures Corporation. Multiple references in this document are given under the terms of fair use with regard to international copyright and trademark law. This is a scholarly reference work intended to explain the background and historical aspects of *STAR TREK* and its spacecraft technology and is not sponsored, approved, or authorized by Paramount Pictures and its affiliated licensees.

All visual materials included herein is protected by either implied or statutory copyright and are reproduced either with the permission of the copyright holder or under the terms of fair use as defined under current international copyright law.

All visual materials used in this work without clearance were obtained from public sources through public means and were believed to be in the public domain or available for inclusion via the fair use doctrine at the time of printing.

Cover art courtesy of SciFi Meshes and Starship Modeler

This work is dedicated to Geoffery Mandel, who started it for all of us.

Memory Alpha and SFHQ/Mastercom cataloging data:
UFP/SFD DTA HR:217622

PART EIGHT

2166-2190: THE DIFFICULT DAYS

OVERVIEW

TIMELINE OF EVENTS

STAR FLEET STARSHIPS

GOLIATH CLASS BATTLECRUISER
BYRNE CLASS HOSPITAL SHIP
TEXAS CLASS LIGHT CRUISER
BOYDEN CLASS AUTOMATED TRANSPORT
WATT CLASS TRANSPORT
BAKINOUR CLASS CRUISER
TRITIUM CLASS BATTLE CRUISER
CARACAL CLASS HEAVY CRUISER
PATTON CLASS DESTROYER
HORIZON CLASS SURVEY CRUISER

CIVILIAN STARSHIPS

ATLAS CLASS SPACE TUG
AURORA CLASS SPACE CRUISER
MURMANSK CLASS TRANSPORT
TETSUJIN CLASS RINGSHIP
RESEARCH SHIP *DEWEY*
MCCORMICK CLASS TRANSPORT
PALOMAR CLASS RESEARCH SHIP
SPACE REFINERY
COSTELLO CLASS SPACE TUG
STELLARFORD CLASS STARLINER

TERRAN EXPLORATIONS:

PYRIMIS A AND B
ALPHA VIRGINIS II

HISTORICAL ARTICLES:

STAR FLEET MUSEUM FOUNDED
GALAXY'S BIGGEST SUPERNOVA EXPLODES
THE FUTURE OF STAR FLEET
MATERIALIZER RESEARCH STOPPED BY COURT
TRANSTATOR INVENTED
FIRST VIOLATION OF PRIME DIRECTIVE
WORLDS IN EVOLUTION ON TOUR
TRITIUM TANKS IN TESTS

SCHEMATICS

ACKNOWLEDGEMENTS



Hell's Gate, portal to the New Territories (c. 2260)



The stricken *Tritium* (NCC-670) drifts helplessly near Luna after its first space trial (2286)



The *Horizon* class survey cruiser *U.S.S. Bach* (c.2190)

2166-2190: The Difficult Days



Those were difficult days. I remember as a junior officer getting bumped from one kind of ship to another. Never the same class twice. I was posted to six different starships in six different classes within ten years I was green then, mind you, and I've learned a lot about what was happening since then. It was as hard on the senior officers as it was for us. If only the damn politicians had left Star Fleet alone, then maybe we wouldn't have gotten in the mess we did. Then again, maybe we would have anyway.

William van Anling
Admiral, Star Fleet (ret.)
(2147-2251)

The period of time from the end of the Romulan War until just before the turn of the 22nd century is known in Star Fleet lore as “the Difficult Days.” It was during these years that Star Fleet seemed to lose its way. The reasons are obvious: hamstrung by a sharply reduced budget, forcibly re-tracked from a purely military organization into a “peaceful exploration force,” and constantly criticized for every misstep no matter how large or small. It was as if the rug of Federation faith upon which Star Fleet had once stood was suddenly yanked from beneath its feet. It stumbled, and continued to stumble for the next few decades, trying to regain a sense of purpose and dedication while fighting off the meddling of Federation politicians all the way.

The end of the Romulan War had brought the first major peace dividend to the Federation. Aside from

the brief police action of fighting the M'dok and the occasional terrorist threat, there would be no major conflicts in Federation space for decades. It is understandable what happened next. History repeated itself, regardless of culture or species or world. The citizens of the Federation grew content and even self-indulgent, quickly forgetting the horrors of the Romulan War in order to resume sedately peaceful lives. The politicians and bureaucrats within the newly re-organized Federation government greedily eyed the large outlays for Star Fleet spending and snatched all that they could. After all, who needed a large military during a time of peace? There was plenty of leftover hardware from the war. Why buy more? So, the funding that would have gone to keep Star Fleet in its prime went instead for public projects such as the Galactic Cultural Exchange, for Federation interstellar fairs, and so on. Only a fraction of its former budget now went to maintain the organization that had fought so hard to bring this peace dividend to life. Only a handful of supporters rose up to defend Star Fleet's development budget in the Federation Council. They were lone voices in the wilderness. Only the renewed possibility of war with the Romulans would finally bring the Council back to its senses. By that time, however, it was too late and the damage had already been done. Star Fleet would have to develop a whole new generation of starships from scratch before it could regain something of its former strength and glory of old.

The drastic reductions in Star Fleet spending in the late 2160s meant that it could no longer order production blocks



of 30, 40, or an “unreasonable” 50 starships at a time. Even an order for as few as 10 was often deemed “a needless waste of public funds.” Star Fleet had to limit its new military starship orders to three, four, maybe as many as a half-dozen vessels in a given class if they were lucky ... but only if they

were warships. Science vessels and transports were seemingly immune to the budgetary axe because they could be used "... for peaceful purposes, which is what the new Star Fleet is supposed to be all about." So the pundits of the day said, and so the politicians believed. Star Fleet Command had no choice but to grit its teeth and humbly accept the new role that was being defined for it: a semi-military enforcer of the peace for who violence was used only as a weapon of last resort. It hid what new builds it could under the guise of "research cruisers" and "science ships" while doing its best to maintain its rapidly aging fleet. Many veterans of the Romulan War could not accept this situation and left the service as quickly as possible, crippling Star Fleet even more. The Federation Council refused to stop this bleeding of talent because former Star Fleet veterans were proving themselves useful in the rapidly growing civilian shipping sector. This loss of a valuable talent and experience pool would hurt Star Fleet tremendously in the years to come.

Councilor T'Mek of Vulcan was typical of the political thinking of the time. She was the ranking member of the Procurement Sub-Committee, and it was she who repeatedly block additional funding for new Star Fleet starship classes.

I fail to see the logic in the outlay of funds for a class of starships with definite military connotations when there exists no clear need for such vessels. There are at present no pressing dangers from species beyond Federation space. What dangers that exist within our borders, such as the occasional terrorist act, have proven to be well within the current operational capacities of Star Fleet. Additional funding for a series of starships intended for wartime activities, which would be operating within a time of peace such as ours, is most illogical.

How far Vulcan had fallen from the days of the Earth-Kzin Wars, when the ability of Star Fleet's Terran ancestor to make war was a subject of praise on Vulcan, not scorn! It proved that even the Vulcans were not immune to the perils of peaceful times.



It is small wonder, then, that the quality of new Star Fleet vessels began to slip as the years rolled by. Despite the best efforts of some within the Starship Design Bureau, the rather unorthodox methods used by some to escape Council limitations coupled with fanaticism towards design preferences of the past would push Star Fleet to the brink of collapse. The highly publicized mess that was the *Tritium* Debacle involved failure at almost every level of the starship design and procurement process. It involved under-the-table deals on a heretofore unprecedented scale in order to build a class of starships that would obviously never work as designed to anyone with decent engineering sense. The end result was a starship that went out of control on its first major space trial, almost killing its crew and coming close to destroying several nearby space stations in the process before its wild tumbling could be stopped. The ensuing scandal would eventually break Cosmodyne Corporation, the main contractor for the *Tritium* program, as evidence of its kickbacks and bribes to cover shoddy contractor work came to light. Most of its senior executive officers would be imprisoned for crimes against the Federation by the mid-2190s, with many a former Star Fleet officer from the Starship Design Bureau sharing their cells with them. With the dissolution of Cosmodyne also came the death of the old Terran "slab hull" starship design philosophy. The *Tritium* Debacle had, more or less, put the final nail in the coffin of a design philosophy that should have been abandoned decades before.

With Star Fleet caught at the literal crossroads by forces without and within, it fell to its remaining civilian allies to take up the slack. Their names are familiar to students of Federation starship history. Cochrane Warp Dynamics of Alpha Centauri, the leader in the field of starship warp engines, along with their “friendly” new rival Kloratis Drive Systems of Tellar ... Chiokis Starship Design of Andor, staunch champions of the old Jeffries Project proposal, who were ready to take it to new and dizzying heights ... Vickers Shipbuilding of Terra, one of its oldest firms and subcontractor of many a Star Fleet design ... the new Deneva Research Station, whose research into microelectronics and materializer theory were about to bear fruit ... and more. Parallel breakthrough developments in many fields were unflinchingly pointing towards a whole new generation of Federation starships the likes of which even the legendary W. M. Jeffries had never dreamed. Only three things were missing from this slow-cooking stew that would make it ready: a new construction material capable of withstanding Warp 4 stress loads, a new starship design that could handle Warp 4 without tearing itself apart, and a new series of starship engines that could push a starship’s cruising speed past Warp 4 and beyond.

The first issue, a new construction material for starship hulls, unexpectedly proved to be the quickest to resolve. Trititanium (also known as *tritanium*) was discovered on the mining planet Motherlode in 2184. Once its elemental properties were determined and analyzed, it soon became clear that it was a natural for use in starship construction. It was as malleable as duraluminium but 21.4 times stronger than diamond. Laboratory tests indicated that a starship built with a trititanium hull could withstand theoretical stresses of Warp 20, five times more than the so-called “Warp 4 barrier” limiting duraluminium hulls. That was the nasty secret behind this legendary speed barrier. It was not that the warp engines of the day were not capable of exceeding Warp 4. It was that the starship frames



being built couldn’t stand the stress. There was no Warp 4 barrier, given the right building materials. Building a starship out of trititanium was an obvious solution to this problem. Its subsequent use on the base frame for the *Horizon*, *Archon*, and later *Mann* classes would prove once and for all that the Warp 4 barrier was nothing more than the myth it had always been.

The second issue, a new starship design, had already been addressed. The pre-war Jeffries Project prototype had clearly shown the direction that future Star Fleet starships needed to take. The rebuilt *Bonaventure* (now lost) and its lone sister ship, the *Bonnie Chance*, were visible proof of the concept. Only the aftereffects of the Romulan War, the technology of the day, the construction limitations of the time, and the severe budget limitations imposed on Star Fleet by the Federation Council had prevented the Jeffries Project from yielding more fruit than it should have. The Federation Council couldn’t see this, though, caught up in post-war politics and more concerned with maintaining the present peace than planning for a future war. They took the excellent performance of the *Daedalus* class cruisers for granted without really knowing, or for that matter caring, what had enabled that excellence in the first place. They repeatedly denied Star Fleet’s requests for more starships of the rebuilt *Bonaventure* configuration until, as they had hoped, Star Fleet finally quit asking.



Fortunately for Star Fleet, its civilian contractors did not have to worry about interference from the Federation Council. They pressed ahead with refining the concepts embodied in the work of Jeffries and

bringing them into the present. Chief among these was Chiokis Starship Design of Andor, one of the strongest backers of Star Fleet in the Federation starship industry. It was they who had helped Star Fleet sneak the *Balkinour* class cruisers past Federation Council limitations, not revealing their military nature until the nearly complete hulls were ready for weapons fitting. In return, a grateful Star Fleet “loaned” the advanced starship *Bonnie Chance* to Chiokis for what they claimed was “routine in-service maintenance.” It was nothing of the sort.

Chiokis engineers were allowed to put the *Bonnie Chance* through every space test they could devise, evaluating its performance under



every conceivable condition as only trained starship engineers could do. The results further augmented the data Star Fleet had already made available to Chiokis from the trial runs of both the rebuilt *Bonaventure* and the original Jeffries Prototype. Chiokis now had all the data it needed to design new types of primary and secondary hulls for the next generation of Star Fleet vessels. The discovery of trititanium shortly thereafter was a literal godsend for this effort. While they waited for enough of this new material to begin construction on a new prototype, Chiokis senior engineer Mark Chausser and his assistant Franz Joseph IV began to work on a new design for a Star Fleet starship. That effort, with additional modifications, would forever revolutionize the Federation starship industry.

Meanwhile, two of Star Fleet’s other primary civilian contractors were hard at work resolving the third issue that blocked development of the next generation of Star Fleet vessels. Cochrane Warp Dynamics had already seen the first production versions of its “Perth” PB-series circumferential warp engines, the PB-2, enjoy great success during the Romulan War.



Their design was proven and reliable, easy to service and maintain, and open to quick upgrade due to the use of boom mounts as opposed to in-hull mounting. Cochrane was as

ready as Chiokis and other Star Fleet contractors for the next generation of starships, and was as equally frustrated when the Federation Council repeatedly refused to grant the necessary funding. Nevertheless, it soldiered on with its own research and development, doing its best to improve upon the promise shown by its postwar PB-6 “Quantum II” warp engine.

The PB-6 was the first Federation warp engine ever designed that could exceed Warp 4. It had proven itself with its exceptional performance on the rebuilt *Bonaventure* and the *Bonnie Chance*. It would have replaced the venerable war-era PB-2 “Quantum I” as Star Fleet’s standard warp engine had not budget cuts imposed by the Federation Council dictated



otherwise. Cochrane almost lost its monopoly on Star Fleet warp engine contracts for the simple reason that the PB-6 was, to quote the Council, “too expensive.” Its next engine would somehow have to be both inexpensive and an excellent performer.

The PB-8 “Quantum III” was little more than a retooled and

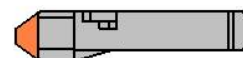

simplified PB-7, with every possible corner cut that would both reduce cost and maintain operational safety. Its main claim to fame was its use on the failed *Goliath* battlecruiser project of 2165. All involved were quick to point out that the engines themselves were not the reason for the *Goliath*’s failure. The engines themselves had performed admirably. The main problem was that they had been attached to a starship that was simply too big and had too many systems for them to handle. Star Fleet was able to salvage Cochrane’s reputation despite the failure by backing them before a hearing of an investigatory subcommittee of the Federation Council. The low-cost PB-8 would become Star Fleet’s favorite “second-tier” engine in subsequent years, often finding its way into fleet upgrade programs, with the last such being the *Marshall-C* refits of the late 2180s.

It was fortunate that newer warp engines from Cochrane were not used on the ill-fated *Tritium*.

Cosmadyne had cut costs by electing to go with modified PB-8s, which was already available in quantity from Star Fleet stores. It was not allowed to cut corners this way with the *Caracal* contract, however. New Cochrane-type circumferential warp engines were mandated (and, surprisingly, approved by the Council) as part of the design. Cochrane was already waiting in the wings with its PB-14 "Pollux." This design had tested at Warp 6 in simulation, although the limitations of the *Caracal* frame would not allow such high speeds. Unofficially, however, one *Caracal* class captain reported making an emergency burst of Warp 5.2 while battling Orion pirates in the Rigel sector. This validated Cochrane's development efforts within the limits of the *Caracal* design, further fueling efforts at developing a more powerful successor. There was no question now that Cochrane Warp Dynamics would have a new generation of warp engines ready for Star Fleet's newest starship ... provided, of course, that the ever-present design and funding obstacles were overcome first.



While Cochrane was absolved of its involvement in the failure of the *Goliath* Program, the fact that the program was a failure gave elements within the Council all the ammunition they needed to open Star Fleet's previously closed procurement process. Star Fleet now had to accept competing bids for its starship systems, with the low bidder (not necessarily the best design) getting the contract. This was the break for which the newly founded Kloratis Drive Systems was looking. It had been continually stymied in its efforts to win a prestigious military contract and boost the new company's reputation. The Council-mandated changes in the Star Fleet procurement process gave it its chance. Its first successful contract was to provide the warp engines for the *Bakinour* sub-class of survey cruisers ... or so Star Fleet said. What Kloratis did not know was that it would be providing the engines for Star Fleet's first military cruiser class since the end of the Romulan War. Truth be told, Cochrane was glad to let them have it ... just in case they were caught in yet another procurement debacle.

The VX-10 "Harpie" was introduced in 2183 as part of the *Bakinour* program. The Kloratis design represented quite a different approach to warp power than the Cochrane norm. For the first time since the war, part of the engine converter assembly was deliberately exposed to open space. Kowloon-Andjong, the precursor to Kloratis, had done the same thing with the war-era *Claudius Ptolemaeus* class starships. This accounted for the VX-10's unusual "crunched cowl" aft section. Improvements in warp engine technology over the past two decades had practically eliminated the high maintenance issues associated with such a design. In operation, the *Bakinour* enjoyed almost the same maneuverability as had the *Claudius Ptolemaeus* without the worry of its engines breaking down at any time without notice. This arrangement gave the *Bakinour*'s VX-10 engines what appeared to be an unearthly glow around their exposed back halves when at warp speed. What mattered more, though, was the savings in power consumption by using the relative vacuum of space for matter/antimatter conversion rather than maintaining a self-contained artificial vacuum.* This largely successful experiment would gain Kloratis its second major contract to procure new engines for the *Tritium* class, resulting in the improved VX-12. It would also be followed upon in other subsequent designs by Kloratis, Cochrane, and other warp engine manufacturers of the era.



(*) The initial startup of a Kloratis VX-10 warp engine was always accompanied by a peculiar "screaming" sound as the matter/antimatter containment field was engaged. This was what earned the design its nickname of "Harpie," evoking the Terro-Centaurean myth of old. The reason for this sound remains a mystery to this day and it gradually went away with more refined Kloratis successor designs.

While these years were a difficult time for the advancement of Star Fleet, they were boom years as far as the civilian



starship industry was concerned. Freed from wartime restraints, armed with the latest technological advances, and enjoying a boom in surplus hulls and parts, civilian starship development in the Federation underwent a virtual explosion following the Romulan War. No less than ten different major civilian starship classes were introduced to Federation service between 2166 and 2190 – all of which were civilian craft. Those were just the significant ones. There were at least twice as many lesser designs, as well as *almost a hundred* different type of the new “personal starships.” These were small, family-sized craft, akin to Terran automobiles of the 20th century or what had been intended with the Cochrane Interstellar Express in 2074. The CIE-07 had been a century too early, however. The post-war boom in the Federation economy, coupled with the relative low cost of late 22nd century starships, finally made personal starflight within the financial reach of all but the poorest Federation citizen. It was a new market waiting to be tapped and Federation businessmen would tap it with a vengeance. The personal starship market would prove so successful that by the end of the century over 20% of Federation families would own their own starship ... and more than one enterprising businessman would make multimillion credit fortunes in the process.

Civilian starship designers of the late 22nd century soon learned that their new customers expected no less of their craft than had Star Fleet or the interstellar trading conglomerates. Most wanted top performance at affordable cost, with travel in relative comfort and provisions for all of the normal amenities of life while enroute. Others wanted vessels tailored to their particular needs or tastes. A dedicated few, the “classic starship” pioneers of this new market, wanted easier access to surplus or decommissioned Star Fleet hulls for restoration or customization. Many companies soon emerged that could address

the needs of all of these. The “classic starship” market had always been there, and always would be, but enjoyed a



newfound popularity as the UESPA Foundation (and later the Star Fleet Association) gave their backing to the business. The “personal luxury” and “high-performance” civilian markets came into being around this time, with each catering to a specific niche of the market. Finally, there was enough business in the Warp 2 “family” market for anyone who could maintain their profit margins without going broke in the process. One of the most surprising players of all in this “new” arena was the mighty Cochrane Warp Dynamics, which could no longer ignore the very industry it had helped to create and subsequently abandoned almost a century before.

Thus it was that while Star Fleet languished and the Federation Council fought over every last credit that it would be appropriated for new builds, the space lanes were teeming with thousands civilian starships of every shape, size, and description. All too soon, civilian designs would be competing with the best of Star Fleet in advancing the future of the Federation starship industry.



TIMELINE OF EVENTS

2160

- Sarek of Vulcan, son of Skon, the most influential Vulcan of his generation, is born in the city of ShiKahr.
- T'Rea, first wife of Sarek, is born.



2162

- The Romulan War ends with a decisive victory for Federation forces at the Battle of Cheron.
- Galactic peace brings the beginnings of tremendous growth in industry and trade.

2163

- The Federation Galactic Outreach Program resumes, having been suspended during the Romulan War.
- The *Atlas* class space tugs enter service. Their first job is to tow the new Neutral Zone outpost stations to their final locations on the Federation side of the Zone.
- A new program of space buoy deployment begins to replace many that were damaged or destroyed during the Romulan War.

2164

- The number of systems that are members of or affiliated with the Federation reaches 100.
- The *Goliath* class battlecruiser prototype is completed and begins its acceptance tests with Star Fleet.
- A new Star Fleet Academy campus begins construction near Star Fleet Headquarters at San Francisco, Terra.

2165

- The *Goliath* class battlecruiser fails its acceptance tests and is rejected for Star Fleet service. More ships of the proven *Marshall-B* class are authorized to fill in the resulting "starship gap."
- Starbase 10 is rebuilt.
- A binary planetary pair in the Pymimis star system is discovered by the survey cruiser *USS Gemini*. Both worlds have unstable orbits and will eventually collide with each other. The inhabitants of both worlds refuse Federation help for religious reasons. Star Fleet is powerless to intervene and forcibly evacuate the Pymimians due to the direct orders of the Federation Council.

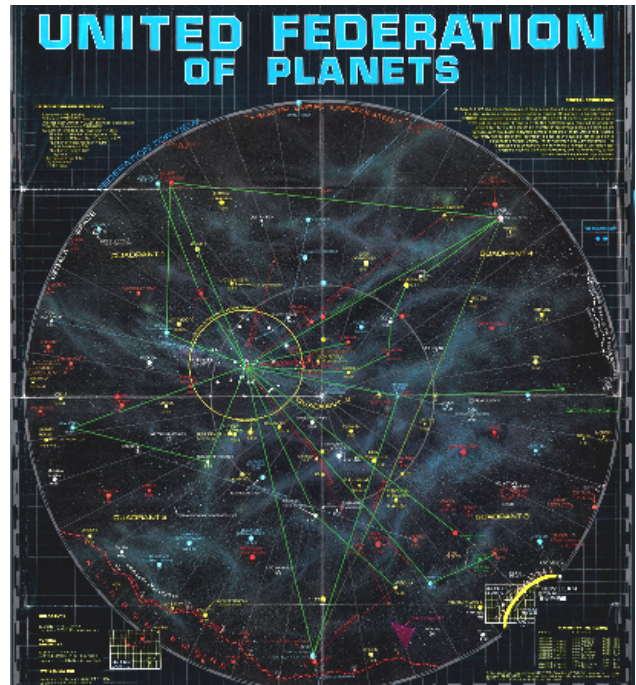

2166

- All of the worlds of the Rigel star system save for Orion and its colonies join the Federation. This causes the Federation to redefine its borders outward, now encompassing a sphere some 480 parsecs in diameter. Most of this newly acquired territory has yet to be properly explored at the time.
- Based on the success of the *Odoacer* class scout, a new prototype "spy ship" is developed for Star Fleet. It will never enter service due to lack of need. It will, however, achieve a sustained cruising speed of Warp 3.96 during its space trials. This will remain the sustained warp speed record for a Federation starship for decades.
- The starbase program, interrupted by the Romulan War, resumes as construction begins on Starbase 12.

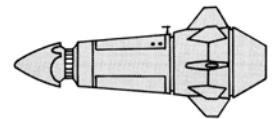

2167

- "First Five Years of the New Federation" news conference admits to a chaotic start; however, all member and affiliated systems express confidence in the new government.
- A renewed Galactic Cultural Exchange program is sponsored by the Federation. Its goal is to share the cultures of all of its member and affiliated worlds as it travels Federation space.

- The *Broadway* class transports enter service. They prove so popular that the design and its derivatives will remain in production, with minor modifications and occasional system and engine updates, up to the present day.
- The *USS Hurok*, a brand-new *Broadway* class transport, takes part in the Galactic Cultural Exchange program by ferrying a human traveling circus to various Federation worlds.
- The *USS Essex*, a *Daedalus* class cruiser, is lost at the moon of Mab-Bu VI.
- The *USS Horizon* visits Sigma Iotia II, shortly after which it is lost. The later *Daedalus*-derived *Horizon* class will be named in its honor.



2168

- The new prototype "spy ship" is ultimately rejected for service with Star Fleet - not for any faults, but due to lack of funding. The Federation Council sees no need for such a craft during a time of peace.
- The *Bonnie Chance*, replacement for the ill-fated *Bonaventure*, is built.
- Founding of the Deneva Research Station. It will ultimately make a name for itself for its pioneering research in two areas: the development of the transtator and perfection of early transporter ("materializer") systems.
- Founding of the "genetically perfect" human colony on Moab VI.
- The new Star Fleet Academy campus on Terra is completed and begins accepting students. The old campus becomes home of the Academy's Command School.

2169

- The *Aurora* class civilian space cruisers enter service. This is the first starship class available to private citizens, albeit at a steep price.



2170

- The Star Fleet Museum is founded on Memory Alpha.
- Utopia Planitia launches the *Tetsujin* class ringships now that peace has returned to Federation space. This will be the last major ringship class ever to see service in Federation spacecraft history.
- Orion closes its ports to Federation shipping. This is an attempt to keep the Federation from discovering its clandestine trading with the Klingon Empire.
- The Venus drug is invented.

- The Eta Serpentis system is colonized by the survivors of the *Terra Five* space ark.
- A new and more powerful form of subspace radio is introduced. It allows for signals to travel at the previously unheard-of speed of Warp 30. This allows for near-instant contact with all but the far border regions of Federation space. The development has immediate, far-reaching impact on interstellar security, trade, and travel.
- The inhabitants of Gamma Spica are saved from destruction thanks to the welcome intervention of the Star Fleet vessel *USS Bellweather*. This is the first major event in which the new version of subspace radio plays a key role.

2171

- Scientists at the Deneva Research Station, under the direction of William E. Abramson, begin a research program that will eventually lead to the invention of the transtator.
- The invention of the replicator all but eliminates famine within the Federation and completely transforms its economy within the quarter-century.

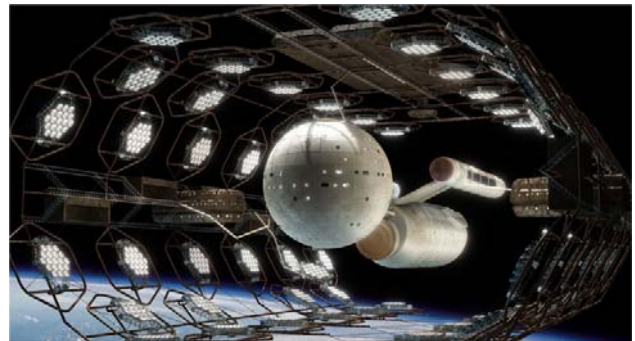

2172

- The massive Centauri Spaceworks opens for business. This is the newest and most modern civilian space construction facility of its day. Star Fleet will eventually take advantage of this facility in the near future by setting up the nearby Proxima Shipyard. The Alpha and Proxima Centauri systems will eventually become major Federation centers of starship construction, repair, and maintenance.
- The well-preserved remains of the galaxy's oldest civilization, the ones who originally sent the signals first detected by Farside Moonbase in the early 21st century, are found on planet UFC 522-IV.

2173

- End of the Vulcan Outreach period (2065-2173).
- The *Byrne* class hospital ships enter service, allowing the aging *Hopkins* class to be retired.
- A major study shows that interstellar tourism may become the biggest industry in the Federation in the years to come.

2174

- The Resolution of Non-Interference is approved by all members of the Federation Council. Its principles will form the basis for Star Fleet's own Prime Directive (General Order #1).
- The explosion of the Phi Puma supernova is the biggest such event in recorded Federation history. The nearby research vessel *USS Kepler* is vaporized in the blast.
- The credit has replaced all local system and planetary currencies as the unit of exchange for goods and services within the Federation by this date.

2175

- The *Bradley* class space tanks are withdrawn from service.
- The *Texas* class light cruiser enters service.
- The twin worlds of Pyrimis collide, killing all life on both planets.
- "Small" personal starships for civilian use (smaller than a cruiser) become affordable for the average citizen around this time.



2176

- The Delta Research Station begins construction.
- The first evidence of extragalactic life is found when an unknown probe resembling an elongated cylinder is recovered from sector 24 of the New Territories. It will not be learned until over 150 years later that it was the first of two Whalesong Probes.
- Former Star Fleet Captain James Smithson is dishonorably discharged for the first recorded violation of the Prime Directive.
- The Orions, under increasing diplomatic pressure from the Federation, agree to reopen their ports on a limited basis.



2177

- The hedonistic lifestyle of the natives of Argelius II quickly make the planet one of the most popular "party hot spots" in the Federation.
- The *Dewey* class "university ship" enters service.
- The *Boyden* class starships are the first unmanned, warp-driven transport craft in the Federation to enter service.

- The Delta Research Station is completed and enters service, drawing in scientists from all worlds and sectors of Federation space.

2178

- The traveling Worlds in Evolution program enables university students across the Federation to witness firsthand various eras in the life cycles of developing planets. The vessel hosting the students in this program is the newly commissioned *Dewey*.
- A "fault" is discovered in the Omega section of the Orion arm of the Milky Way galaxy. This "fault" is discovered to be the cause of a ring of novas throughout Federation history, including the recent Phi Puma explosion.



2179

- The *McCormick* class factory ships enter service.
- Grahd of Tellar develops the transporter matrix at the Deneva Research Station. This device finally permits the lossless transmission of organic matter through a "materializer" while retaining life. "Materializers" will eventually be renamed "transporters" due to the significance of Grahd's breakthrough.

2180

- Star Fleet issues its famed White Paper report of this year: *The Future Fleet - A Blueprint for the 23rd Century*. It correctly predicts the need for a greatly enlarged Star Fleet by the year 2200.
- The Federation Council refuses requests by Star Fleet for additional funding for new warship classes in order to update its fleet. The aging *Marshall* class destroyers must remain the backbone of the fleet for the time being. The completion of Starbase 12 also will be delayed for decades due to lack of sufficient funds.
- On Terra, the New World Economy begins to take shape. All forms of money are eventually abandoned as the Federation credit becomes the preferred unit of exchange for goods and services.
- The *Watt* class cargo ships enter service.
- A lawsuit is filed against the Deneva Research Station in order to prevent the testing of



"materializers" on living organic lifeforms. The contention is that a being dies once it is dematerialized and reduced to a matrix-stored data pattern. Any rematerialized life form is not the living original, which makes the materializer "a murder machine." The case has enough legal merit to put a stop to continued materializer research and will remain tied up in Federation courts for years.

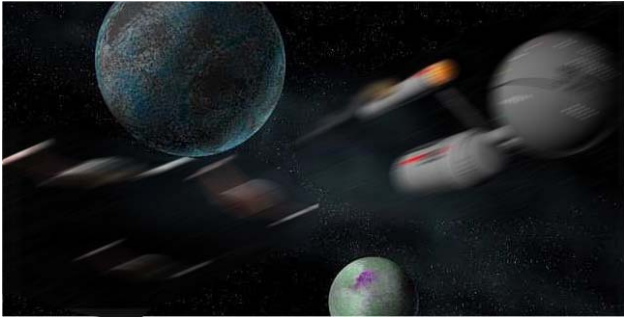

2181

- An "incident" occurs involving the illegal colonization of the planet Charlemange within the Neutral Zone. This causes the Federation Council to reverse its decision and release funds to Star Fleet for new starship construction. This will result in the *Patton*, *Tritium*, and *Caracas* starship programs.
- The *Mercury* class scouts are retired.

2182

- After 20 years, the new Federation has matured into a stable, ever-growing alliance of star systems.
- The *Palomar* class research ships enter service.
- The *Powers* class scouts are withdrawn from service.

2183

- The first mobile space refineries enter service. These mobile refining platforms, equipped with warp drive, are designed to travel to remote areas and provide industrial capabilities until the local infrastructure has built up enough to take over for itself. While their main job is to process antimatter for starship engines, they are large and versatile enough to take on refining of raw planetary materials as well. Due to their unique nature this "class" is never retired, remaining in service with constant upgrades to this day.
- The first intelligent avian humanoids are discovered on Alpha Virginis II, a planet located in Sector 14C.
- The *Atlas* class space tugs are withdrawn from service.
- The *Bakinour* class cruiser enters service.
- Star Fleet is reorganized under the terms of the new Star Fleet Charter.

2184

- Federation research into weather control systems, a necessary part of advanced terraforming techniques, begins paying big dividends. Planets that were once unproductive worlds can now be transformed into worlds with viable ecosystems.
- Trititanium (aka *tritanium*) is discovered on the mining planet of Motherlode. Its use in future starship construction will revolutionize the industry.



NOTE: The discovery of trititanium (trititanium) removes the key impediment limiting starship design: the ability to build a space frame that can withstand speeds of Warp 4 or greater.

- Standardized Federation police craft enter service, replacing the ships of "local fleets" for routine tariff and customs duties.
- The last of the Federation's individual member "local fleets" are dissolved; however, many Federation affiliates choose to retain their own for various reasons.



2185

- The *Stellarford* class spaceliners enter service. These opulent vessels, which evoke the old Terran *Magellan* class, have double the passenger capacity and the longest range of any commercial starship in Federation space.
- Part of the *Stellarford* program includes an impulse-driven "space plane" capable of carrying small to mid-sized cargoes or 65 passengers. The design proves so popular that a warp-capable version is soon sold as a starship in its own right. The Stellarford Shuttleplane soon becomes the most recognizable civilian spacecraft in known space.

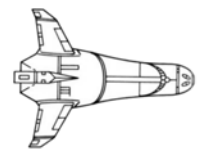

- William E. Abramson of the Deneva Research Station, working in conjunction with Daniela Vukovic and Mareechi Govindarajan of the University of Mumbai on Terra, jointly develop the transtator. This important breakthrough in microelectronics will become the foundation for all modern Federation electronics. Abramson will insist that Vukovic and Govindarajan take full credit for the actual invention of the device and leaves the Deneva Research Station shortly thereafter, never to be seen again. Vukovic and Govindarajan will later credit Abramson as the true genius behind the basic theory of their their invention.

NOTE: The development of the transtator is as important to the Federation-wide “electronics revolution” at the turn of the 22nd century as the discovery of trititanium was for the starship industry. The subsequent duotronics computer systems breakthrough, spearheaded by Dr. Richard Daystrom, would not have been possible without the development of transtator-based technology. Duotronic computers were necessary to provide “spot-on” adjustment to a starship’s warp field, thus making possible non-conventional starships such as single-engine and tri-engine designs

- A Federation merchant captain named E. A. Jacoby encounters a previously unknown humanoid species in a bar on one of the Orion colonies. They pump him for information while keeping him in the dark as to their origins and homeworld. Jacoby later passes on a routine first contact report to the local Federation representative but it gets lost in bureaucratic red tape. This incident marks the first-ever known encounter with the Klingons.



2186

- Chiokis Starship Design of Andor begins researching the possibilities of using trititanium for starship hulls. Their lead engineers have realized that trititanium will finally make possible the “thin disc” primary hull first attempted with the *Bonaventure* in 2165. It will also give a starship the ability to withstand frame stresses well above the legendary Warp 4 limit for current starship designs.



2187

- Star Fleet's first mobile drydock, the DD495, enters service.
- First recorded sighting of a Tholian ship.
- The *Patton* class destroyers enter service. This is nothing more than a modernized version of the old *Marshall* design with new weapons, engines, and on-board systems. Most of the older *Marshall* class starships still in service will receive a *Patton*-style “*Marshall-C*” upgrade to keep them current with their newer siblings. The subsequent success of the stopgap *Patton* class will eventually free up additional funds for other, newer designs.



- The *USS Tritium* goes out of control during its first major space trial due to severe warp field imbalances inherent in its triple engine design. Fortunately, the stricken ship is brought to a stop without any harm to life or property. This design error is but one of many flaws discovered after the failed test, further compounded by the fact that the class had already begun construction before the prototype had been evaluated. All ships under construction have to be modified while still in drydock to address all the flaws found during the *Tritium*'s first space test. The “*Tritium* Debacle,” as it will become known, costs Star Fleet billions in credits. Many Star Fleet officers and civilian personnel associated with the *Tritium* will lose their jobs. It also results in Cosmodyne Corporation, the prime contractor for the program, going into receivership within the decade. The affair will cause the name *Tritium* to be associated with any costly starship design that appears to be a failure (“... we’ve got another *Tritium* on our hands”).



2188

- The revised production model of the *Tritium* class starships enters service. They will never perform up to spec due the flaws that still remain in their design. No additional hulls will be ordered beyond the six that were already under construction at the time of the *Tritium* debacle.
- A new personnel shuttle is introduced along with the *Tritium* class starships. These shuttles will outlive their inglorious contemporary in service with Star Fleet by fifteen years.
- The tricorder makes its debut in Star Fleet service when its use helps to stop a major plague outbreak on Rigel II.

2189

- The *Caracal* class cruisers enter service. These will be the last of the Terran "slab hull" starships designs to ever see service with Star Fleet.
- The Perth PB-18 warp engine is developed by Cochrane Warp Dynamics. It will play a prominent role in the next two generations of Star Fleet starships once its initial kinks are worked out and it finally enters production.



NOTE: The development of the PB-18 warp engine is the last major key element in ushering in the first "modern" generation of Federation starships at the beginning of the 23rd century.

- Birth of Robert Townsend April, future first captain of the starship *Enterprise*, in Coventry, England on Terra.



2190

- The interplanetary civil war within the Beta Cersus system, itself within the Neutral Zone, threatens to reignite conflict with the Romulans for a time. The fear of another war causes the Federation Council to release funds for more Star Fleet starships.
- The *Normandy* class starfighters are withdrawn from service.
- Chiokis builds its first "thin disc" small-scale starship prototype. The program is overseen by Mark Chausser, a human engineer and longtime employee of Chiokis. His assistant on the project is a young Franz Joseph IV, is a rising star in the Chiokis design department.
- The *Horizon* class survey cruisers enter service at the end of the year. They are the last new-build Jeffries-style designs not to have a disc-shaped primary hull.



Experimental materializer, Deneva Research Station (c. 2170)



A civilian transport nears its destination (c. 2170)



USS Kepler at Phi Puma prior to its destruction (2174)



Alpha Virginis II (2183)



Image from the Beta Cersus interplanetary war (2190)

STARSHIPS

***GOLIATH* CLASS BATTLECRUISER**

SERVICE ENTRY DATE (OLD CALENDAR): N/A

The *Goliath* was ordered during the dark days of the Romulan War (2160-2161), when the threat of Local Group invasion was all too real. It was the first Star Fleet vessel to evoke the image of the Terran aquatic dreadnought – a gigantic starship optimized for heavy firepower, designed to blast into the heart of the Romulan Star Empire at Warp 4 while destroying everything in sight. It was also Star Fleet's first colossal failure of this period in Federation spacecraft history.

The biggest problem with the *Goliath* was that it was too large. It was too massive and had too many systems for its engines to handle all at once. The end result was little more than a dreadfully sluggish, badly overgunned monitor. In theory it had a cruising speed of Warp 3.5. In space trials it could barely manage Warp 3. In combat trials it could be outmaneuvered even by an old Warp 2 freighter. The *Goliath* project was abandoned immediately after its space trials, after which the disarmed prototype was sold to recoup its development costs.

SPECIFICATIONS:

| | |
|-----------------------|---|
| Length: | 312 m |
| Beam: | 189 m |
| Draft: | 95.6 m |
| Mass: | 245,000 DWT |
| Crew | 375 |
| Armament | 20 laser banks 18 particle beam cannons 16 fusion torpedo tubes |
| Cruising speed: | warp 2.8 |
| Maximum speed: | warp 3.1 |

VISUAL:

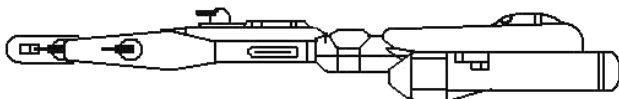

ORIGINAL DESIGN BY RICK STERNBACH
CLASS NAME AND SCHEMATIC BY STEVE BARON

***BYRNE* CLASS HOSPITAL SHIP**

SERVICE ENTRY DATE (OLD CALENDAR): 2173

The *Byrne* class was designed to replace the slow and aging *Hopkins* class in the mobile hospital role. They were a rather straightforward conversion of the *Infinity* class starliner (a competitor of the *Tetsujin*). The eleven-deck command module was gutted and retooled according to the strict specifications of Star Fleet Command. The rest of the ship, aft of the command boom all the way to its aft observation section, was replaced by a custom-designed medical section designed to handle up to 500 patients at once. The large observation deck ring was retained because of its spacious shuttle bays, which were perfect for housing a number of space ambulances, medical shuttles, and other specialty small craft. The first two were *Infinity* conversions, with the other five assembled in dock. Their specialty maintenance requirements (for their civilian-derived power plants) eventually led Star Fleet to convert some of its own designs for the hospital ship role beginning with the *Baton Rouge* generation of starships.

SPECIFICATIONS:

| | |
|-----------------------|------------------------------------|
| Length: | 290 m |
| Diameter: | 137.3 m |
| Mass: | 100,520 DWT |
| Crew | 420 (+ up to 500 patients maximum) |
| Armament | 4 laser banks |
| Cruising speed: | warp 2.0 |
| Maximum speed: | warp 3.1 |

VISUAL:

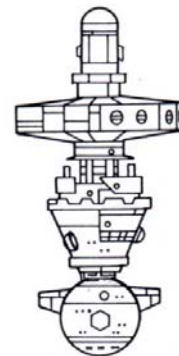

ORIGINAL DESIGN BY RICK STERNBACH

TEXAS CLASS LIGHT CRUISER

SERVICE ENTRY DATE (OLD CALENDAR): 2175

The base design for the *Texas* class was a holdover from the Romulan War – a vessel intended not only to take punishment but to dish it out as well. As such it was something of an anomaly in the peaceful post-war era. Authorization for construction was cancelled and then reapproved several times before it was finally given the go-ahead in mid-2170. 50 were originally conceived back in 2160; by the time approval finally came through and the Federation Council had their way that number had been cut down to just 12. They were built as originally designed and as such was the last Star Fleet starship class to have laser-resistant armor plating. This had been rendered obsolete by the development of force field shielding systems during the War; however, Star Fleet saw this as an excellent opportunity to rid its inventories of excess reserve armor. What little was left over from the building of the *Texas* class was eventually sold.

These ships were obsolete from the moment they entered service. Their one saving grace was that they were one of the few Star Fleet starship classes designed for a planetary landing and take-off. As such they found their purpose as fleet support roles, often serving as fire support ships or ground support vessels. They excelled in the latter role, where their heavy weapons and armor plating would make them a favorite with the Star Fleet Marines during the war-torn days of the early 23rd century. Eventually 4 of these would be turned over to the Marines, who had them rebuilt as “commando cruisers” with modern warp engines and weaponry to better support their operations. The only obvious visual differences between this configuration and the original were the new PB-32 warp engines and the removal of the main navigational deflector from the front underside of the ship. These *Texas*-based “commando cruisers” would go on to become the longed-lived starships still in service with Star Fleet (120 years) when this document was published.

As of this date all *Texas* class light cruisers save the 4 in Marine service have been decommissioned. Only 6 remain in the Star Fleet Reserve, with the others having been sold or scrapped.

ORIGINAL SPECIFICATIONS (2175):

| | |
|-----------------------|---|
| Length: | 189.9 m |
| Beam: | 85.3 m |
| Draft: | 50.1 m |
| Mass: | 112,000 DWT |
| Crew | 140 |
| Armament | 6 laser banks 2 fusion torpedo tubes |
| Cruising speed: | warp 3.0 |
| Maximum speed: | warp 3.6 |

SCHEMATIC:

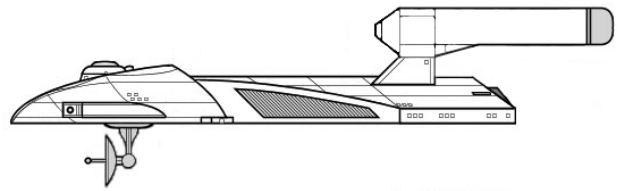

Configuration as-built (2176)

Note the use of PB-7 warp engines derived from the *Goliath* project

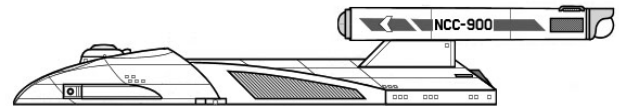

“Commando cruiser” configuration (c. 2260)

As fitted with standard Class I era PB-32S series warp engines and main deflector removed for ground support operations

VISUAL:



Pictures provided courtesy of the Star Fleet Marines

TEXAS DESIGN BY STEPHEN V. COLE (AMARILLO DESIGN BUREAU)
ORIGINAL SCHEMATIC BY NEALE DAVIDSON
WITH ALTERATIONS BY RICHARD E. MANDEL
3D MESH AND MODEL BY TED W. GIEBEL

BOYDEN CLASS AUTOMATED TRANSPORT

SERVICE ENTRY DATE (OLD CALENDAR): 2177

The *Boyden* class automated transports were the first Star Fleet vessels of this era in which the Federation Council approved high build numbers. This was largely due to the inexpensiveness of their unusual design. Conceived by Gulliver GPF, they featured an old-style, spiked-antimatter, rotary fusion reactor feeding two engine nacelles mounted top and bottom. The technology involved hailed from the Earth-Kzin Wars. By this time, however, spiked antimatter engines cost next to nothing to build; hence the almost instant approval of the class by the Council. 108 of these odd-looking craft were produced in two blocks between 2177 and 2190. Their only real flaw was that as automated vessels they were easy prey for space pirates and other looters, so they usually traveled in small convoys with at least one Star Fleet or several police vessels as escorts. Their odd design and overall reliability endeared them to Star Fleet Transport Command, for whom they would serve for the next half-century before retirement.

SPECIFICATIONS:

Length: 62.6 m
 Beam: 31.0 m
 Draft: 39.5 m
 Mass: 40,360 DWT
 Crew none
 Armament none

Cruising speed: warp 2.0
 Maximum speed: warp 3.0

VISUAL:

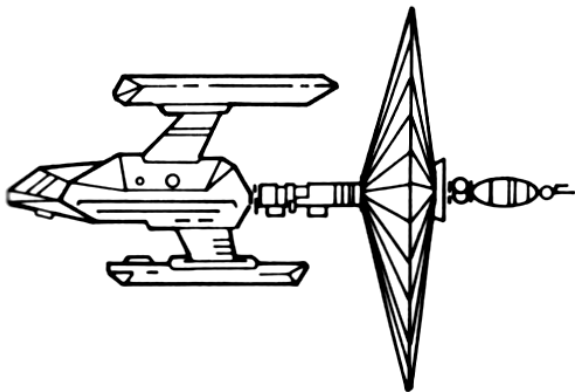

BOYDEN DESIGN BY RICK STERNBACH

WATT CLASS TRANSPORT

SERVICE ENTRY DATE (OLD CALENDAR): 2180

This was Star Fleet's first major post-war fleet transport class. It was very much a military design, with both high speed and high payload capacity. It had dual towing pads that could accept any of Star Fleet's standardized transport containers of the day. This necessitated the mounting of its dual warp engines in an over-under configuration, mimicking the arrangement of the older *Boyden* class automated transport.

The *Watt* class has the distinction of not losing any of its members to space piracy during its long service record. They would remain in Star Fleet service until the introduction of the Class II starship program in the early 23rd century. Most were sold to the civilian sector after their decommissioning, where many continue to serve to this day.

SPECIFICATIONS:

Length: 164.2 m
 Beam: 113.2 m
 Draft: 34.0 m
 Mass: 89,000 DWT
 Crew 60
 Armament 4 laser banks

Cruising speed: warp 3.0
 Maximum speed: warp 3.8

VISUAL:

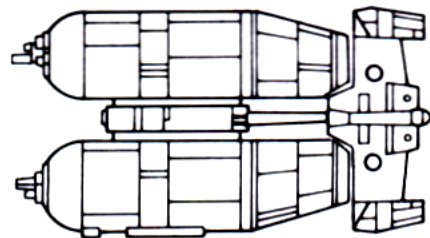

WATT DESIGN BY RICK STERNBACH

BAKINOUR CLASS CRUISER

SERVICE ENTRY DATE (OLD CALENDAR): 2183

The *Bakinour* was an experiment in converting a *Daedalus* class starship into a purely military vessel. The reason Star Fleet was able to get away with this was because the funding for the *Bakinour* had already been approved as a "survey cruiser" under the *Daedalus* program. The *Bakinour* would be the first of six *Daedalus* hulls that were squirreled away by Star Fleet in the late 2170s for conversion to a more militaristic design. No more would be built due to the Council relenting on additional appropriations for new starship classes a few years later.

There are three obvious differences between a *Bakinour* and a standard *Daedalus*. The first is the increased armament, with multiple dual-mount rotating laser banks and torpedo tubes both fore and aft. The second is the secondary hull, which was a Chiokis design based directly off of the Jeffries Program prototype of the 2150s. Its streamlining helped make the *Bakinour* more maneuverable at warp speed. Finally, the third (and most obvious) difference is in the warp engines. Its dual Kloratis VX-10 "Harpies" were an experiment at utilizing the natural near-vacuum of space instead of an artificial vacuum in the warp power process. Data gleaned from the VX-10 would prove useful in the development of subsequent VX-series engine designs.

SPECIFICATIONS:

| | |
|-----------------|--|
| Length: | 103 m |
| Beam: | 55 m |
| Draft: | 44 m |
| Mass: | 47,500 DWT |
| Crew: | 75 |
| Armament: | 8 laser banks (4 dual turrets) 2 fusion torpedo tubes (1 each fore and aft) |
| Cruising speed: | warp 3.3 |
| Maximum speed: | warp 3.8 |

VISUAL:



DAEDALUS DESIGN BY WALTER M. JEFFRIES AND GREG JEIN
BAKINOUR EXTRAPOLATION BY ARIDAS SOFIA

PATTON CLASS DESTROYER

SERVICE ENTRY DATE (OLD CALENDAR): 2187

The *Patton* class was the first of three new starship classes that were part of Star Fleet's first major rebuilding effort after the Romulan War. It was named for the famous *Cavalry* class destroyer lost in the first battle of the Romulan War. It represents the last major iteration of the venerable *Marshall* class destroyer design. All of its laser systems were upgraded with more modern and powerful units on a two-for-one mount basis. The particle beam cannons were also removed and replaced with additional fusion torpedo tubes and magazines. The *Patton* class also got the latest in warp technology upgrades, with Star Fleet standard PB-7 circumferential warp engines replacing the obsolete Westinghouse models of old.

36 of the new *Patton* class destroyers were built to bring the numbers of the *Marshall* class up to 100 vessels strong. In addition, a *Patton*-style upgrade was performed on most of the older *Marshall* class vessels. This is often referenced as the *Marshall-C* upgrade in publications on the subject. Both the *Patton* and upgraded *Marshall* classes would remain in service with Star Fleet at full strength up through the end of the 22nd century. The last *Patton* was decommissioned in 2217.

SPECIFICATIONS:

| | |
|-----------------|--|
| Length: | 225.1 m |
| Beam: | 117.0 m |
| Draft: | 45.5 m |
| Mass: | 24,500 DWT |
| Crew: | 157 |
| Armament: | 11 laser banks (7 fore / 4 aft) 5 fusion torpedo tubes (3 fore / 2 aft) |
| Cruising speed: | warp 3.2 |
| Maximum speed: | warp 3.8 |

VISUAL:

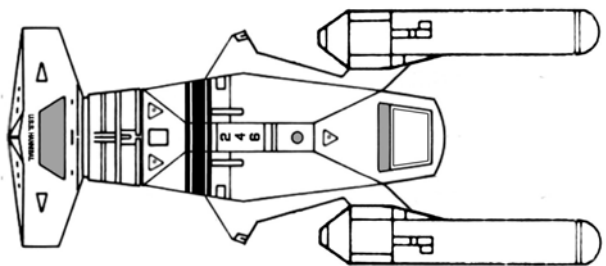

PATTON DESIGN BY RICK STERNBACH AND STEVE BARON
AS REWORKED BY RICHARD E. MANDEL

TRITIUM CLASS BATTLECRUISER

SERVICE ENTRY DATE (OLD CALENDAR): 2188

The *Tritium* was the second of three new starship classes in Star Fleet's aborted rebuilding effort of the mid-2180s. It is also the reason why the effort collapsed. It is a legend among Star Fleet starship captains and engineers – not because of what it did; rather, what it failed to do. It was supposed to be the most advanced and powerful starship of its day, with its highly touted triple warp engine design theoretically capable of maintaining a cruising speed over warp 4. Instead, it wound up being a colossal failure, embarrassing Star Fleet to no end and becoming its second major design failure since the end of the Romulan War. The *Tritium* debacle was the most costly mistake in Star Fleet history. Thankfully, it has never been repeated.

According to most experts, the only two good things to come out of the *Tritium* program were its 12-person shuttlecraft and the introduction of the tricorder as Star Fleet's first all-purpose survey tool for landing party teams.

SPECIFICATIONS:

Length: 202 m
Beam: 161 m
Draft: 118.6 m
Mass: 476,000 DWT
Crew 250
Armament 12 laser turrets

Cruising speed (actual): warp 3.2
Maximum speed (actual): warp 3.6

VISUAL:



TRITIUM DESIGN BY RICK STERNBACH
MODEL IMAGE COURTESY OF STARSHIP MODELER

CARACAL CLASS CRUISER

SERVICE ENTRY DATE (OLD CALENDAR): 2189

The *Caracal* class, the third in Star Fleet's aborted rebuilding effort of the mid-2180s, represents the last gasp of the prewar angular design philosophy that for so long defined the look of Star Fleet vessels. One of the most touted aspects of its design was a new weapons system whereby each bank of lasers could be independently controlled or linked together through any of the local control stations. The *Caracal* class somehow survived the turmoil surrounding its sister class, the failed *Tritium* class battlecruiser, to eventually enjoy a reputation as a reliable, if not exactly attractive, Star Fleet cruiser class. As one of only two new-build starship programs to survive the *Tritium* Debacle, Star Fleet would go on to refit many of the *Caracal* class for a variety of different roles in order to cover the rapidly growing obsolescence of the rest of its fleet.

The *Caracal* class might have been forgotten had it not been for one incident, which would forever change the course of Federation history. On 17 July 2223 the *Caracal* class cruiser *Audace* (NCC-757) broke contact with Star Fleet after reporting that it was in pursuit of an unidentified alien vessel that had been attacking Federation shipping in its sector. It was never heard from again and no recorder-marker was ever recovered. The *Audace* was operating only 7 parsecs from Klingon space at the time of its disappearance. Most historians believe that the *Audace* was the victim of a Klingon sneak attack, making it the first Star Fleet vessel ever destroyed by the Klingon Empire.

SPECIFICATIONS:

Length: 197.2 m
Beam: 101.6 m
Draft: 51.6 m
Mass: 170,000 DWT
Crew 220
Armament 12 phaser turrets
Cruising speed: warp 3.6
Maximum speed: warp 4.8

VISUAL:

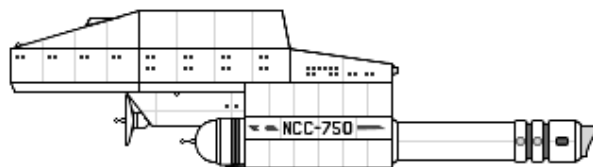

CARACAL DESIGN BY TODD GUENTHER
SCHEMATIC BY NEALE DAVIDSON

HORIZON CLASS HEAVY CRUISER

SERVICE ENTRY DATE (OLD CALENDAR): 2190



The failure of the *Tritium* program marked the end of the old Terran “slab hull” philosophy of starship design. The ongoing shakeup within the Starship Design Bureau ensured that the future of Star Fleet vessels lay firmly in designs following the Jeffries Project configuration. On top of this, the overall obsolescence of Star Fleet, highlighted by two border incidents with the *Romulans*, was finally beginning to make itself felt. A sharply divided Federation Council voted in late 2188 for Star Fleet to begin construction of more ships-of-the-line – provided, of course, that budgets were met and a proven design were used. These restrictions were unwelcome news Star Fleet, as it had wanted to build starships to a more advanced design. It saw no way out of this situation until senior Chiokis designer Mark Chausser pointed out that Star Fleet already had such a design in hand. What it could do was build an upsized *Daedalus* incorporating the latest in starship technology. Hidden beneath its hull would be a modern trititanium frame, ready for next-generation upgrades once the Council approved the move. Cochrane Warp Dynamics was still working the bugs out of its new PB-18 warp engines and the *Caracal*'s PB-16s had proven more expensive to build than first anticipated. A slightly retooled version PB-6, the same as used on the *Bonnie Chance*, would do nicely and help keep production costs down. The passing of almost three decades now meant that the once-expensive PB-6s were actually cheaper to build than the newer PB-16s. The class would be named after the pre-war *Horizon* class survey cruisers, now decommissioned, which was another calculated ploy designed to draw Council support. Chausser's plan worked, with the Council approving 14 *Horizon*-class ships for construction without objection.

The fact that the new *Horizons* were significantly larger than their *Daedalus* predecessors made no difference insofar as warp performance was concerned. The only real difference, other than the size, was the relocation of the warp engine pylon mounts farther back on the secondary hull. This made for a sturdier starship and eliminated all of the pylon stress problems that had plagued the older *Daedalus* class.

Only 13 of the 14 *Horizon* class starships were eventually built. The speed at which they entered service indicates just how ready Star Fleet and its subcontractors were to roll on an advanced starship design. Also, beginning with the second production block, Chiokis sneaked in a new version of the secondary hull it had first tried with the *Bakinour* class. The Council would later cancel the last *Horizon* in order to approve six ships of the similar *Daedalus*-upsized *Archon* sub-class.

The *Horizon* and *Archon* class starships signaled the end of Star Fleet's “Difficult Days.” The next generation of Star Fleet vessels would be like no other that had come before.

SPECIFICATIONS:

| | |
|-----------------|--|
| Length: | 294.1 m |
| Beam: | 117.1 m |
| Draft: | 46.0 m |
| Mass: | 71,000 DWT |
| Crew: | 310 |
| Armament: | 9 lasers banks 2 fusion torpedo tubes |
| Cruising speed: | warp 3.4 |
| Maximum speed: | warp 3.9 |

COMPARATIVE VISUALS:

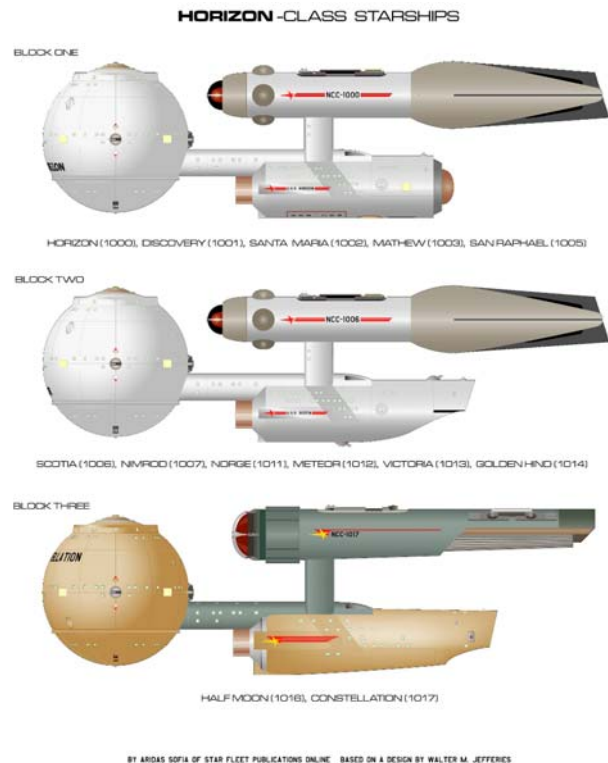

DAEDALUS DESIGN BY WALTER M. JEFFRIES AND GREG JEIN
HORIZON EXTRAPOLATION BY ARIDAS SOFIA

CIVILIAN STARSHIPS

ATLAS CLASS TUG

SERVICE ENTRY DATE (OLD CALENDAR): 2163

As the original Federation's first major starship class was a transport, so too was the new post-war Federation's first major starship class of non-military origin. The *Atlas* was a civilian design, intended to replace the many aged space haulers and tow vehicles that had fallen victim to Romulan attacks. There was nothing glamorous about them. They were essentially two warp engines attached to a tractor grapple, with a minimal shuttle bay and small command/crew module forward of the grapple assembly. Their only real claim to fame was in being the first Rigellian design to see Federation service.

The first assignment of the *Atlas* class was also its most important. It was to tow the newly built, asteroid-based Earth Outpost Stations (EOS) into location so they could begin monitoring the Neutral Zone. They were always accompanied by a Star Fleet squadron in the event of any trouble. All outposts were placed without incident and the *Atlas* class soon returned to more mundane tasks within Federation space.

SPECIFICATIONS:

Length: 79 m
Beam: 38 m
Draft: 15 m
Mass: 24,500 DWT
Crew 30

Cruising speed: (unladen) warp 2.75
Maximum speed: (unladen) warp 3.5

SCHEMATIC:

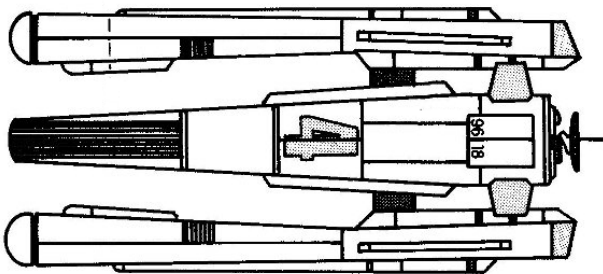

AS DESCRIBED AND DRAWN BY LAWRENCE MILLER
ADAPTED FROM AN ORIGINAL DESIGN BY RICK STERNBACH

AURORA CLASS SPACE CRUISER

SERVICE ENTRY DATE (OLD CALENDAR): 2169

The *Aurora* originated as a Vulcan "pleasure craft" that caught the eye of many a Terran visitor to Vulcan and its space colony worlds in the post-war era. Permission was eventually granted to copy the design so long as they left Terran factories unarmed. The *Aurora* class thus earned the unique distinction of being the first ever warp-powered civilian starship offered for sale after the end of the Romulan War. 269 of these six-person civilian starships would be built by 2180, with 3 major (*Aurora*, *Montcalm*, *Merido*) and 34 minor known different design variations. Among the various buyers were Federation politicians, business magnates, entrepreneurs, and wealthy families. The *Aurora* class was not limited to civilian use alone, though. In 2174, space cruisers of Duotechnica's *Meridio* sub-class would find their way into Star Fleet service as diplomatic couriers and low-priority transports. The Vulcan design heritage of the *Aurora* class ensured long service lives, with many still in service even today.

SPECIFICATIONS:

Length: 21.1 m
Beam: 19.7 m
Draft: 10.6 m
Mass: 18.75 DWT
Crew 6

Cruising speed: warp 1.0
Maximum speed: warp 1.6

VISUAL:

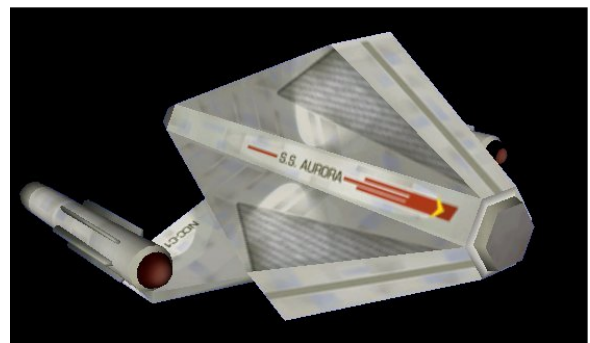

ORIGINAL DESIGN BY WAH CHANG
3D MESH AND MODEL COURTESY OF BATTLECLINIC

MURMANSK AND BROADWAY CLASS TRANSPORTS

SERVICE ENTRY DATE (OLD CALENDAR): 2167

The *Broadway* class starships began life as the civilian *Murmansk* class cargo ships. The basic design of these post-war craft was far more robust than the pre-war *Merchant* class, with some thought actually given to systems reliability and creature comforts. The technology boom resulting from the Romulan War also gave these civilian vessels capabilities that would have been unheard-of prior to 2155. They had modern warp engines (military surplus), a six-deck command area, a six-deck crew section, a modern celestial navigational system (military surplus), the capability to make planetary landings, and a *real* tractor grapple instead of the old pre-war hook-and-latch system. Although intended for use as ore haulers, their ability to be fitted with various cargo containers or customized secondary hulls offered many conversion and operational possibilities. Finally, they weren't all that terribly expensive, given the recent flood of surplus military hardware and starship components on the starship market. The *Murmansk* quickly established itself as a reliable design and soon became the new darling of the civilian sector. Their popularity can be judged by a particularly large order for *Murmansk* class transports being placed by the fledgling Federation Merchant Marine in 2166.

When the Federation Bureau of Education was looking for a starship class to use for its renewed Galactic Cultural Exchange project, the popular *Murmansk* proved a logical choice. Several ships were purchased and converted to the *Broadway* configuration in a joint operation with Star Fleet Command. Star Fleet did the conversion and piloted the ships, while the Bureau of Education paid for the conversion and made an extra donation to Star Fleet's credit-hungry coffers. Yes, it was a political deal, but without it the Galactic Cultural Exchange program was dead in space.

The *Broadway* configuration replaced the *Murmansk's* tractor grapple with a permanent secondary hull. Just under half of this was made of storage holds, while one-fourth was comprised of passenger staterooms and the other one-fourth tailored to the specific needs of the Cultural Exchange Program. The remaining space was used for a four-bay shuttlecraft hanger. Minor changes to the ship itself were also made, such as Star Fleet standard shipboard systems and the addition of an extenso-boom navigational deflector.

Just as the original *Murmansk* had won the hearts of the Federation shipping sector, so too would the spinoff *Broadway* class. The *Broadway* class starship *USS Hurok* was seen all across the Federation during its days with the Cultural Exchange Program. While audiences were wowed with the entertainments it brought with its visits, local starship captains marveled at the near-perfect balance of its mixed cargo

capacity. Demand for availability soon became so great that its original manufacturer reverse-licensed the *Broadway* configuration from Star Fleet and began filling orders as fast as it could. The income from the lucrative *Broadway* license helped the credit-strapped Star Fleet maintain a semblance of a starship development program in between the intermittent funding grants from the Federation Council during this time.

Not only are both the *Broadway* and *Murmansk* class starships still plying the Federation spaceways today (thanks to routine upgrades), but their "little brother" is also doing the same. The "Spacematic," first introduced at the end of the 22nd century, was nothing more than a scaled-down, *Murmansk*-derived design aimed at the growing "solo operator" market. Its lines follow that of the original *Murmansk*, however, the reduced size limits its crew and cargo carrying capability. Like its famous predecessor it has a tractor grapple instead of a dedicated cargo hold, allowing it to mount a wide variety of small-scale specialty cargo containers. The "Spacematic" has since become as ubiquitous in Federation space as its large-scale ancestor, and one can usually be seen (in various configurations) in almost every major Federation port-of-call.

SPECIFICATIONS:

Length: 250 m
Beam: 51 m
Draft: 61 m
Mass: 33,000 DWT
Crew 33
Armament normally unarmed, depends on ownership

Cruising speed: warp 3.5
(maximum speed depends on engine upgrades installed)

VISUAL:

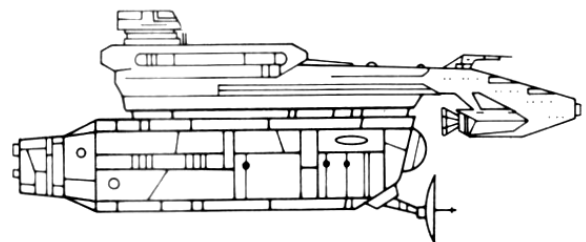

ORIGINAL DESIGN BY RICK STERNBACH
CLASS NAME AND 3D MODEL BY STEVE BARON

TETSUJIN SERIES RINGSHIP

SERVICE ENTRY DATE (OLD CALENDAR): 2170

The boom in civilian space travel and tourism following the end of the Romulan War strained the Federation spaceliner companies to their limits. This motivated the development of several new classes of starliners during this era. Utopia Planitia's *Tetsujin* class was but one of many competing in an already crowded market. It easily stood out from the rest because it was the only ringship in the field. Small wonder then, that despite its limited passenger accommodations it was the most popular civilian spaceliner by far until the opulent *Stellarfords* came along. It was patterned after the legendary *Declaration* class of the mid 21st century, and thus could draw on the exploits of the *Enterprise* and other ships of that era for prestige (and dinnertime stories). Utopia Planitia's designers ensured, though, that the new *Tetsujin* series had the latest in starship technology incorporated into their design. This would be the last major ringship class ever built in the Federation; however, many still survive and continue in service to this day.



SPECIFICATIONS:

Length: 315 m
Diameter: 205 m
Mass: 68,500 DWT
Crew 73 (+ 125 passengers)

Cruising speed: warp 3.2
Maximum speed: warp 3.5

VISUAL:

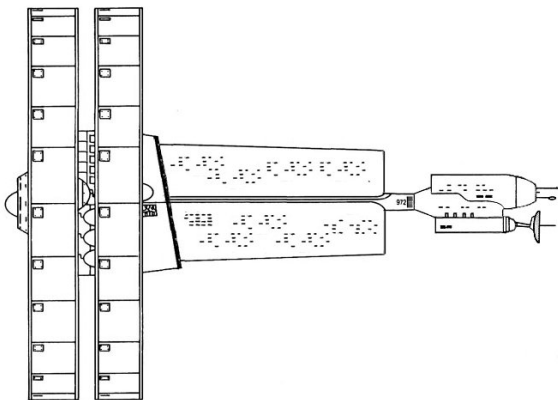

ORIGINAL DESIGN BY RICK STERNBACH
AS MODIFIED BY LAWRENCE MILLER AND RICHARD E. MANDEL

RESEARCH SHIP *U.S.S. DEWEY*

SERVICE ENTRY DATE (OLD CALENDAR): 2177

The *Dewey* was meant to be the lead ship in the *University* class of research vessels. Based on a stripped-down *Marshall* hull, these would have been essentially flying universities (hence the name), bringing the latest knowledge and education to Federation worlds. Cutbacks in funding for new ship construction a few years later resulted in the *Dewey* being a one-of-a-kind starship. It nonetheless served the Federation with distinction and is perhaps best remembered today for its traveling "Worlds in Evolution" exhibit. The *Dewey* was finally decommissioned in 2216 and scrapped shortly thereafter.

SPECIFICATIONS:

Length: 238 m
Beam: 196 m
Draft: 66.7 m
Mass: 58,000 DWT
Crew 80 (+ 300 students)
Armament none

Cruising speed: warp 3.2
Maximum speed: warp 3.5

VISUAL:



DEWEY DESIGN BY RICK STERNBACH
3D MESH BY STEVE BARON

McCORMICK CLASS FACTORY SHIP

SERVICE ENTRY DATE (OLD CALENDAR): 2179

The factory ship concept came about as a way to move advanced refining capability out to colonies located in distant areas of Federation space. These usually had abundant raw materials but no means by which to process them for transport. The ideal would be for a *McCormick* class starship to land near the colony (usually in a nearby ocean or other large liquid body that could support its mass) and have the materials brought to it. Once it had processed all that it could, it would then take off and carry its cargo back to the nearest commercial company hub for distribution or further processing. The invention of the replicator, followed within decades by the perfection of the materializer (i.e transporter), would eventually make such ships obsolete. A number of these old hulls would find new lives, stripped of their on-board refining capacity and retooled for bulk cargo hauling, as the *Brek* class transports of the 23rd century

SPECIFICATIONS:

Length: 300 m
 Beam: 275 m
 Draft: 94.8 m
 Mass: 230,600 DWT
 Crew 200
 Armament none

Cruising speed: warp 2.8
 Maximum speed: warp 3.2

VISUAL:

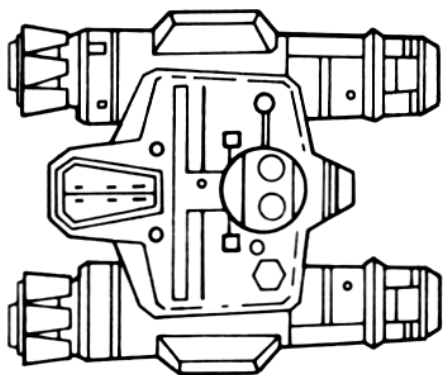

McCORMICK DESIGN BY RICK STERNBACH

PALOMAR CLASS RESEARCH SHIP

SERVICE ENTRY DATE (OLD CALENDAR): 2182

The *Palomar* class started out life as the *Padish*, a starship built for use by the Denebian Academy of Sciences. Its unusual insect-like configuration made it one of the most recognizable starship designs in Federation space. The *Padish* proved so popular with visiting Federation scientists that the Federation Council commissioned the Denebians to build four more expressly for Federation-wide use, using Star Fleet standard control systems and interior arrangements. All would be named for famous scientists of Terran history. The *Palomar* class starships would spend their entire service careers mapping out the mysteries of space within the Federation's newly expanded borders. All were decommissioned by 2220.

SPECIFICATIONS:

Length: 100 m
 Beam: 70.3 m
 Draft: 50.2 m
 Mass: 36,700 DWT
 Crew 53
 Armament 4 laser banks

Cruising speed: warp 3.0
 Maximum speed: warp 3.3

VISUAL:

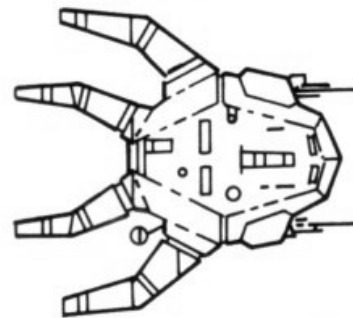

PALOMAR DESIGN BY RICK STERNBACH

MOBILE SPACE REFINERY

SERVICE ENTRY DATE (OLD CALENDAR): 2183

The need for large amounts of raw antimatter to power Federation starships saw the construction of these gigantic space refineries in 2183. They could either create raw antimatter from available matter or process natural antimatter wherever it might be discovered. They had no propulsion save for maneuvering thrusters and were usually towed into position by warp-powered tugs. They proved their value during the Four Years War with the Klingons (2246-2250), helping to keep Star Fleet vessels in the field while the limited Klingon fuel stores and stretched supply lines more than once caused their ships to withdraw from battle.

This “starship class” (although technically a mobile base) has never been retired due to its unique, one-of-a-kind nature. Star Fleet provides generous assistance to the civilian sector in their maintenance, modernization, and occasional upgrading because of their impact on fleet operations. The construction of a new mobile space refinery nowadays is rare, usually happening only when an older one wears out or is destroyed.

SPECIFICATIONS:

| | |
|----------------|-------------|
| Length: | 335 m |
| Beam: | 315 m |
| Draft: | 163 m |
| Mass: | 375,000 DWT |
| Crew | 85 |
| Armament | none |

VISUAL:

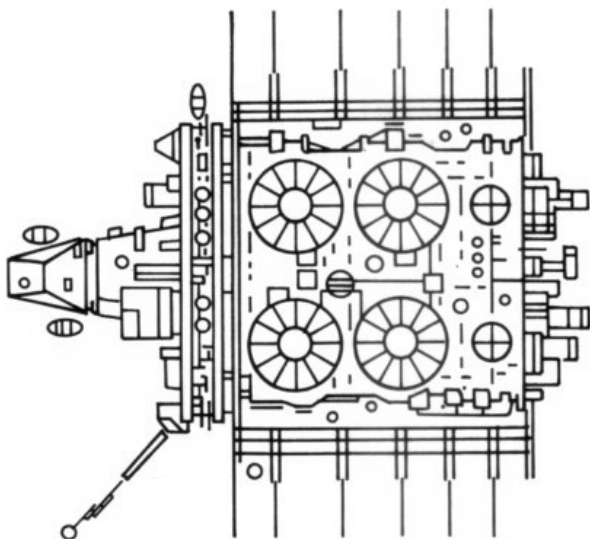

MOBILE SPACE REFINERY DESIGN BY RICK STERNBACH

COSTELLO CLASS SPACE TUG

SERVICE ENTRY DATE (OLD CALENDAR): 2183

While the *Goliath* had failed Star Fleet as a battlecruiser, its oversized hull and cumbersome ways suggested a different occupation to its new civilian owners before it went to the breakers. Some two decades later, in 2183, a one-third scale version of the *Goliath* entered civilian service as the *Costello* class space tug. It was designed for the express purpose of towing the massive new mobile space refineries to their desired locations within Federation space. The reduction in size and new warp engines worked wonders for its power consumption requirements, enabling it to tow five times its own mass while maintaining a Warp 2.5 cruising speed. The maneuverability problems that had plagued its *Goliath* ancestor did not matter in the *Costello*'s case, where its most common maneuvers were planetary orbit and straight-line travel between systems. The *Costello* also quickly replaced the recently retired *Atlas* for large-scale cargo hauling, whenever its services were not required for moving a space refinery. It thus remained at the forefront of civilian service for some four decades before being replaced by more advanced designs. The last *Costello* was scrapped in 2221.

SPECIFICATIONS:

| | |
|----------------|------------|
| Length: | 106 m |
| Beam: | 65.2 m |
| Draft: | 41.3 m |
| Mass: | 87,500 DWT |
| Crew | 73 |
| Armament | 4 lasers |

| | |
|----------------------------------|----------|
| Cruising speed (unloaded): | Warp 3.0 |
| Maximum speed (unloaded): | Warp 3.3 |

VISUAL:

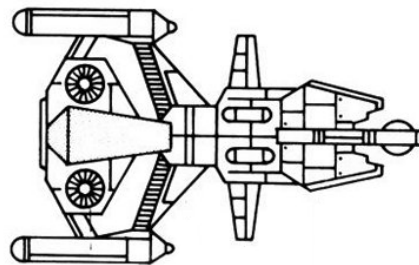

GOLIATH DESIGN BY RICK STERNBACH
COSTELLO ADAPTATION BY LAWRENCE MILLER

STELLARFORD CLASS STARLINER

SERVICE ENTRY DATE (OLD CALENDAR): 2185

The *Stellarford* class starliners were the largest capacity passenger starships ever built. These had double the capacity of their largest predecessors (2200 passengers and crew), the latest in the civilian warp engines, and a cruising range that was the same as the most advanced Star Fleet starships of their time. They were extremely popular with the burgeoning space tourism industry of the day, frequently charted for pleasure cruises to such spectacular stellar phenomena as the Jewel Stars. Their standard for luxury and opulence has yet to be matched.

All *Stellarford* class starliners had their original P-700 warp engines replaced with civilian model PB-16S circumferential warp drive units around the turn of the century. All were officially retired by 2221, however, they were reactivated and pressed into service as troop transports during the Four Years War (2246-2250). This was due to their sheer volume, which no other dedicated Star Fleet design at the time could match. While in temporary service with Star Fleet all were fitted with four phaser banks for defensive purposes. These were removed once they were returned to reserve status. At least two still survive as of this date in the Federation boneyard at Qualor II.

SPECIFICATIONS:

- Length: 264 m
- Beam: 105 m
- Draft: 96.8 m
- Mass: 34,000 DWT
- Crew 200 (+ 2000 passengers)

- Cruising speed: warp 3.2
- Maximum speed: warp 3.5

VISUAL:



STELLARFORD DESIGN BY RICK STERNBACH
3D MESH AND MODEL BY STEVE BARON



The final sunrise of Pyrimis A (2175)

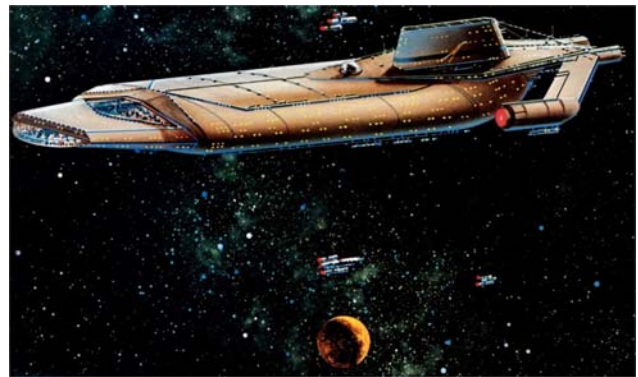

The *Stellarford* class starliner *USS King Charles* (2187)



Cosmandyne corporate headquarters (2188)



A UFP Infonet reader's take on the *Tritium Debacle* (2188)

TERRAN EXPLORATIONS

PYRIMIS A AND B

The twin worlds of Pyrimis were first visited by the starship *USS Gemini* in 2165. They were (and still are) the only planetary binary pair ever discovered to share identical orbits, as opposed to a single orbit with a binary orbital relationship. Under normal conditions the planets would be locked in some form of stable Trojan relationship with the star Pyrimis and each other. Unfortunately, by the time the *Gemini* discovered these worlds their orbital relationship had begun to decay due to gravitational instabilities within the system's failing star. This had caused their normal orbital arrangement to fall out of sync, with the end result being that Pyrimis A was now "chasing" Pyrimis B. The planets were destined to collide within a decade.

Upon analyzing the *Gemini's* readings of the system and their inescapable implications, Captain Carlos Don Passos immediately made contact with the planetary governments of both Pyrimis A and B. Both planets had spacefaring societies on the verge of interstellar flight, with Pyrimis B having been colonized by Pyrimis A some fifty Terran years before. Both were well aware of the *Gemini's* arrival in their system and had initiated contact with the Federation vessel of their own accord. To the dismay of Captain Passos, though, the governments of the people of Pyrimis refused his offer of Federation assistance in evacuating their doomed worlds. They had already detected the orbital changes and were well aware of their implications. Their religious beliefs held that it was not their place to tamper with "the fate of the gods" and that if their culture was doomed to extinction, then so be it. The Federation was thus powerless to intervene in the loss of all life within the Pyrimis system in 2175, when the planets finally collided with each other. Fortunately for posterity, however, the people of Pyrimis permitted those few among them that did not share their beliefs to be evacuated, along with complete records of their history and culture. Less than a thousand of the people of Pyrimis thus escaped the destruction of their worlds. They were eventually resettled on the Federation colony world of Agleb III.

The odds against the occurrence of such an unusual binary planetary arrangement such as that found in the Pyrimis system are so astronomical that outside intervention in aeons past is certainly suggested, although unproveable. Most stellar historians point out that if such were the case then their arrangement does not fit the pattern of standard Preserver planetary engineering efforts. Never in any proven Preserver-altered system has such a shared-orbit arrangement been encountered. No such arrangement has been discovered since.



Pyrimis A (*left*) and Pyrimis B (*right*)

System star: UFC 151423 (*Abihsoð*)

| | |
|---|-------------------------------------|
| Distance from system star | 148 million km (both) |
| Period of revolution (Terran measure) | 23.26 hours (both) |
| Period of orbit (Terran measure) | 347 days (both) |
| Mass | 9.5×10^{24} kg (both) |
| Diameter | 11,394 km (A) 11,379 km (B) |
| Axial inclination | 22° (A) 20.6 (B) |
| Average surface temperature | 21° C (both) |
| Satellites | none |
| Planetary classification | M |
| Level of technology | spacefaring (interplanetary) |
| Indigenous culture(s) | humanoid (<i>homo pyrimis</i>) |
| Additional culture(s) | none |

ALPHA VIRGINIS II

The star Alpha Virginis was known to early Terran astronomers as Spica. It is home to the first intelligent avian species ever encountered by the Federation. They are known as the Canaris and somewhat resemble the ancient Terra *archaeopteryx*, only one-and-a-half times as large. They are a benevolent species whose aggressive instincts have been bred out and methodically de-emphasized over thousands of generations. Violence is almost unknown on their world save for the ritual hunts retained as a rite of passage into adulthood. The Canaris have kept this practice so that their young will understand from whence they came and why their species has rejected such a way of life. The Canaris culture is in stark contrast to those of other intelligent avian lifeforms such as the Skorr, where predatory instincts and skills are not only maintained but also valued above almost all else. The Aurelians are the only avian lifeforms whose native culture even approaches that of the Skorr, but even with them the ways of their predatory nature are still an essential part of their daily lives.

The main export of Alpha Virginis II is its so-called "Spican flame gem." This is a ruby-like crystal with such a high refractive capability that it is naturally faceted, appearing to glow and twinkle when exposed to even the smallest of light sources. Unfortunately, this natural faceting is too dense and irregular for industrial applications, but that did not stop its use in the jewelry and home décor markets. Such was their use on their native planet, where the Canaris wore them as decoration or used them to fashion beautiful "crystal lamps" for use at night. They were once prized for their rarity, being found only on Alpha Virginis II, but in 2235 a joint Terran-Tellarite business conglomerate found a way to produce Spican flame gems by artificial means. These artificial crystals are not as "fiery" as true Spican flame gems; nevertheless, they have so inundated the market over the past six decades as to decrease the value of the real ones to that of common gemstones. Most independent interstellar traders nowadays usually carry a number of artificial flame gems as part of their "seed stock" in peddling their wares. Real Spican flame gems, on the other hand, are usually found only in name brand costume jewelry and other such mainstream marketing venues.



System star: Alpha Virginis (*Spica*)

Distance from system star 130 million km
Period of revolution (Terran measure) 16.61 hours
Period of orbit (Terran measure) 288.93 days
Mass 5.8×10^{24} kg
Diameter 6331.7 km
Axial inclination 19.8°
Average surface temperature 16.6° C

Satellites none
Planetary classification M
Level of technology none

Indigenous culture(s) avian
(aves pteryx canaris)
Additional culture(s) none

HISTORICAL ARTICLES

STAR FLEET MUSEUM FOUNDED

UFP INFONET – 21 JUNE 2170

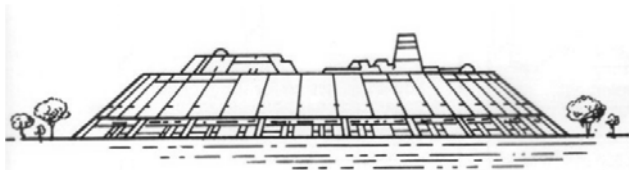

Today in official ribbon-cutting ceremonies presided over by Romulan War hero William Larson, Memory Alpha opened its new Star Fleet Museum to the general public. This special exhibit hall will have numerous displays on the history of the Federation's main exploration and peacekeeping arm, from its rise as a Terran space military force to the present. Admiral Larson, who commanded the famed Triangle Campaign of the war, still looked imposing in his war-era uniform as he conducted the first tour of the Star Fleet Museum for visiting dignitaries and reporters on behalf of the UESPA foundation. Among the highlights of the exhibits were an actual DY-500 series starship used in the First Earth-Kzin war, a reproduction of the bridge of the *USS Amity* (the first Terran starship to make contact with the Vulcans), a tri-vid holosim of life aboard the Tellarite space ark *Gartov*, and a full-size cutaway of an early Vulcan warp engine. Star Fleet has thrown its full support behind the new Star Fleet Museum, promising to donate several retired starships to be fixed in orbit as permanent displays that can be visited via orbital shuttle once the logistics are worked out.

GALAXY'S BIGGEST SUPERNOVA EXPLODES

UFP INFONET – 30 JANUARY 2174



The most powerful interstellar event in Federation history took place today as the star Phi Puma went supernova at the far edge of Federation space, destroying its entire star system and the nearby research ship *USS Kepler*. The crew of the *Kepler* had been monitoring the star's variances and were well aware that it could go nova at any time. However, according to Star Fleet spokesman Marty Snyder, they were caught at unawares by both the suddenness and ferocity of the explosion, which exceeded their calculated safety parameters.

"They would have had enough time to escape if it had gone off as predicted," Snyder said during the briefing. "For whatever reason, though, it went supernova instead of just nova. They just had just enough time to turn the ship around and try to ride the shockwave when it hit them. I would have done the same thing, but that shockwave was just too powerful. We lost contact the moment it hit them.

The *Kepler* is currently listed as "missing, presumed destroyed." Long range sensors have detected no sign of the ship. Long range estimates give just twenty-five years before the massive, radiation-soaked shockwave strikes Bayard's Planet, the nearest inhabited Federation world. Preparations are even now underway to deal with this situation before the shockwave arrives.

THE FUTURE OF STAR FLEET

JAYNZ DEFENSE WEEKLY – 6 AUGUST 2180



The following editorial was submitted Jaynz special guest writer Admiral Gulval Thronlev (ret.). Admiral Thronlev led the Andorian flank forces during the successful Federation offensives in 2161-2162 that brought an end to the Romulan War.

Today I live in peace. My mate and my grandchildren enjoy a serenity that I have seldom known. It is hard for me, an Andorian born and bred in the ways of the warrior, to adjust to such a life. I know many of my former Andorian and human comrades who feel the same. We can but watch from the side as the peace we worked so hard to build corrodes the very Star Fleet that helped make it possible.

Today I received two gifts from old friends. One was a display model from the NX-Project by one of its former engineers. It now sits on my desk, its sculpted *vras* showing the sleek lines of the starship that he had designed for the Federation before the War. Had those who build our starships known how to make such a vessel work in that time, then perhaps the War would have turned out very differently. As of now, though, it is still a dream. My friend continues to dream that dream and I wish him well. Perhaps someday he can build that ship. Perhaps someday the *Loknar* will become a reality.

The other was from an old friend in Star Fleet Command. It was a copy of this year's White Paper, as the humans call it, describing the state of the fleet and what needs to be done to keep it strong. This year, however, it was something more. It laid out a vision for a new Star Fleet not all that different from what my other friend had foreseen with the NX-Project. A whole new generation of multi-mission starships, capable of both protecting the Federation while exploring its boundaries, flexible for any mission that the Council could dream up for them. It too is a pleasant fantasy, I fear. It lays out in clear terms what needs to happen in order to Star Fleet alive, yet the Council will not give so much as a single credit for the necessary outlays to

make this dream come true. "We are at peace," the councilors say. "We need no new starships. The old ones are good enough." That is the reasoning of a fool, one who can no longer dream and who has forgotten by whom and for what price this peace was made possible.

It is only when we chase our dreams, pursue them, do everything we can to make them come alive, that we advance. It was such a dream that brought about the Federation in the first place. Now I fear that the lack of such vision is affecting us. I can see it happening all around me. Have we forgotten so soon what we suffered only a short time ago? Have we forgotten that we once fought to save that dream – that we will have to fight again someday to protect it?

Today I live in peace. I am an old warrior whose sword has been taken away. Now I play with my grandchildren by day and satisfy my mate at night. As of today, though, a model made of *vras* now sits on my mantel in my study. It reminds me of for what I once fought, and of a dream that should not be allowed to die.

MATERIALIZER RESEARCH STOPPED BY COURT ORDER

UFP INFONET – 21 JULY 2180



United Federation of Planets
Deneva Regional Sector Court

Case No: R7Q-114BR-549

Plaintiff: Dr. Harding Richardson
Chief Medical Officer
Deneva Research Station

VS

Defendant: Dr. Janet Hester and staff
Materializer Project Division
Deneva Research Station

For good cause shown,

IT IS HEREBY ORDERED that Defendants Dr. Janet Hester, her staff and associates of the Materializer Project Division, and all Deneva Research Station staff associated with said project, are hereby enjoined from:

- 1) conducting any further testing of the experimental device known as the Materializer on organic material of any kind from any Federation world,
 - 2) conducting any Materializer operations with regards to organic material from a non-Federation world,
 - 3) performing any research or side activities that would assist in the performance of Materializer operations on organic material, and
 - 4) releasing any research notes, documentation, samples, equipment, or any other information or devices that would assist in the furtherance of Materializer research with regards to the transmission of organic material to other parties within Federation borders.
-

IT IS FURTHER ORDERED that the Deneva Constabulary, acting in conjunction with local Federation law enforcement officials, shall seal the Materializer Research Laboratory and impound any and all materials found within in order to prevent their continued use in this project.

IT IS FURTHER ORDERED that the Defendants will surrender all research notes, materials and devices with regards to the transmission of organic material by use of their Materializer. Said materials shall be stored within the sealed Materializer Research Laboratory pending the outcome of this legal action no later than 48 hours with receipt of this order.

IT IS FURTHER ORDERED that the Defendants will present themselves to this court on 28 July 2180 (Terran Old Calender) for an initial inquiry into the charges leveled by the Plaintiff against the Defendant with regards to the ethics of this research as it pertains to Federation law.

So ordered this 21st Day of July, 2180 (Terran Old Calendar),

(signed)

Marla Rhue
Presiding Judge
Deneva Regional Sector Court

TRANSTATOR INVENTED

UFP INFONET – 14 APRIL 2185



The University of Mumbai has announced what may be the most significant breakthrough in Federation microelectronics in our lifetimes. Dubbed the *transtator* by its inventors, Daniela Vukovic and Mareechi Govindarajan, this revolutionary new take on optiquad bioelectronics holds enormous promise for new, miniaturized data processing hardware.

“Well, it’s not really our invention,” Ms. Vukovic said at a recent press conference. “Bill Abramson over at the Deneva Research Station has been developing the basic theory for years. He’s the one who should be getting all the credit, not us. All we did was build the hardware.”

Mr. Abramson was unavailable for comment.

FIRST VIOLATION OF PRIME DIRECTIVE

UFP INFONET – 15 MAY 2176



The “trial of the century” is now over. Former Star Fleet Captain James Smithson has been dishonorably discharged and incarcerated following his court-martial for violation of the Prime Directive. This Star Fleet regulation, based on the Federation Council’s new policy of non-interference with the cultures of newly contacted worlds, was grossly violated by Smithson in the line of duty. He ordered the crew of his starship, the *USS Carolina*, to open fire on nuclear missiles that had been launched at opposing sides on a inhabited planet in the Vega Proxima system. When his helmsman refused to carry out his order, Captain Smithson shoved him aside and fired the ship’s lasers himself, destroying the lead missile. The EMP from the resultant explosion knocked out most of the other missiles in the attack wave. No more missiles were fired and both sides survived the attack; however, Commander Blaise Tremond promptly relieved Captain Smithson of his command for interfering in the Vega Proxima war. Star Fleet Command backed Tremond’s actions and, in today’s final court-martial proceedings, stripped Smithson of his command and commission as well as sentencing him to indefinite detention pending a suitable punishment for his crime.

“This is something that never should have happened,” said Commodore Thaddeau Stoner, the officer-in-charge of the court martial board, when asked about the ruling. “Our ground observation teams report that the inhabitants of Vega Proxima are now so scared of ‘alien attacks’ that they’ve gone completely insular. The whole planetary culture is collapsing in on itself, and all because of the actions of *one man*. That’s why we have a Prime Directive, people. It keeps us from destroying cultures like Vega Proxima.”

WORLDS IN EVOLUTION ON TOUR

UFP INFONET – 18 JULY 2178



Beginning next school term, a most unusual university will be joining the ranks of academic institutions across the Federation. It is the *USS Dewey*, a starship built for the purpose of serving as a flying university. A group of handpicked students, representing the best and brightest in the Federation's various pre-college and university establishments, will spend the next year visiting a group of planets selected for being prime examples of their evolutionary type. This "Worlds in Evolution" program is designed to teach students about planetary development and the evolution of associated life forms.

Dr. Chun Ji, the *Dewey's* archaeology and anthropology officer, was quite ecstatic about the new program. "We're going to the Phygon proto-planet and we'll be dropping by Tan Tauri to show them a world where the lifeforms are just on the verge of crawling up on land. We'll also be going to Episolon Reptus to show them some honest-to-goodness dinosaurs. Forgive me if I sound like I'm babbling, but frankly I'm excited and a little nervous. I haven't seen some of these things myself! To think that I'm finally going to see a dinosaur. Oh, if only I didn't have to worry about a bunch of students nipping at my heels! The things I could learn."

Jarnak of Tellar is one of the students who will be boarding the *Dewey* for its maiden voyage. "It *is* an opportunity to expand one's horizons, so long as our instructors don't get all moon-eyed during the trip. I'm here to learn, not tell my teachers how to do things. That was my problem back on Tellar -- I was ten times smarter than the stupid bores at the front of the hall. Would you believe that I could pass every one of their so-called tests with ease but that they could never pass mine? Of course you do. This program should be grateful to be graced with my superior intellect. I have in mind a number of changes which will make it more beneficial and educational for all."

Fortunately, at that point, young Jarnak was called away on other business.

TRITIUM TANKS IN TESTS

BILL CULLAR –UFP INFONET EDITORIAL – 11 OCTOBER 2187



I saw in the news where they finally managed to tow Star Fleet's flying crapper back to port – or rather, what was left of it. The crew was so badly banged up that they're going to be in the hospital for weeks. They're lucky that piece of junk didn't take out O'Neil Freeport with it when it went out of control. Frankly I'm amazed that thing even managed to stay together as hard and fast as it was spinning. I didn't think anything that big could roll and tumble like that, but it did. That crew's lucky they're still alive.

Which leads me to my point. Why in the hell are my tax credits going to pay for a piece of (censored) like THAT?!?! I thought Star Fleet was supposed to be the best and brightest among us, with the best starships that ever flew. I'm tellin' ya, if that's *their* idea of a good starship I think we'd all be better off down here on Earth. I don't spend my hard-earned money on worthless (censored) and Star Fleet shouldn't either. I tell you what, if I could ever find out who was the sunva(censored) that built that piece of (censored) I'd kick his ass from here all the way to Rigel and then back again just for good measure. Star Fleet my ass – (censored) Fleet is more like it.

to be continued ...

ACKNOWLEDGEMENTS

VOLUME 8: 2166-2190

AUTHOR'S COMMENTS:

There is method to my madness in describing this installment of the *Federation Spaceflight Chronology* the way I do. A lot of *TREK* tech fans are fascinated by what they call the “pre-TOS era.” These are the starships that must have existed before the time of the original *STAR TREK* television series. A lot of people have had different ideas about these over the past fifty years and even Paramout has all but ignored this part of *TREK* history. Who’s to say who’s right and who’s wrong? Goldman and Sternbach’s original SFC seemed to suggest the best approach in bringing everybody’s ideas under one roof as best I could. Per their concept this was a formative time “between generations,” as it were. Instead of lots of a few important classes of starships you get a few of a lot of different kinds of starships. There’s lots of the tried-and-true and lots of experimentation going on in this 25-year window. A similar thing happened in the United States Navy between the First and Second World Wars, where you see a lot of major ship classes with only a few ships in them. That to me seems the best way to account for so many divergent designs in the pre-TOS era. Star Fleet was experimenting simply because it didn’t have any choice in the matter. It was a military organization trying to keep its head above water in a time of peace. It couldn’t afford the massive build numbers of earlier starship classes because the Federation Council saw no need for them. Only when the threat of war reared its ugly head again did they come to their senses. Had they waited another decade or two, then our favorite starship crew might have been speaking Klingon instead of Universal.

For the timeframe covered in this issue I’ve tried to pick what I feel are the best and most consistent designs from the various *TREK* tech schools of thought. Aridas Sofia (*Federation Reference Series*) has done some wonderful work in fleshing out the evolution of the *Daedalus* class, bringing it forward towards the TOS era (as talked about in both TOS and TNG). We might have our differences as to just how long that evolution lasted but his efforts deserves their place here all the same. Todd Guenther’s *Caracal*, one of the classics of the old TOS blueprint era, has long seemed out of place among the Class I starships but now one can see just where it came from and why. It’s a holdover from the pre-Romulan War design school whose closest cousins in this era are the uprated *Patton* class destroyer and that debacle of debacles, the *Tritium* class battlecruiser. Add to that the appropriate civilian ships from the old SFC and you get a nice, varied mix for this issue. Believe me when I say I could have added a lot more in here but I didn’t. Differences with everyone aside, I want to leave everyone plenty of elbow room to “have it their way” on the road to the TOS era. That’s why

only a few of the plethora of starships everyone has conceived are represented here.

My apologies for the crudeness of the *Tetsujin* class ringship. Yes, it’s a hastily doctored “Sternbach ringship” with a significantly larger hull for use as a starliner. That was one of the major gaffes of the old SFC, as Sternbach has since acknowledged. His ringship design was too small to hold hundreds of passengers as described. I both increased the size of the hull and reduced the passenger complement. Maybe someone can sweet-talk Aridas into designing us a new one, eh? You *know* how he likes ringships. - _ ^

I’d like to give special kudos to Maeteen Greenway at this time for his 3D model of the *Horizon* class survey cruiser. Of all the images of the later *Horizon* floating around out there on the Internet at the time this was published, his was one of only two that even came close to the original design concept by Aridas Sofia. Now if we could just fit some PB-6s on that bad boy!

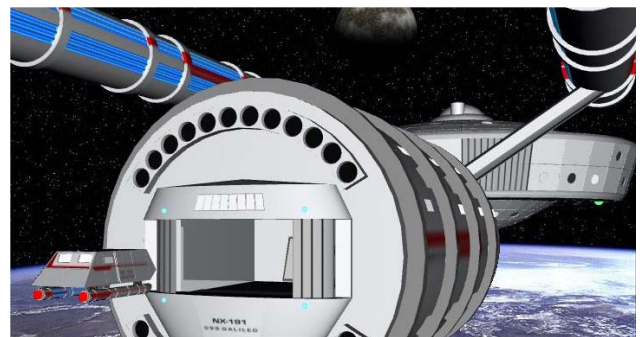

I realize I’m retconning somewhat on the *Horizon* and *Archon* class starships. As I see it the real pros at the Star Fleet Starship Design Bureau and Chausser’s team over at Chiokis had already gotten their act together and were ready to roll on the “real” next generation of starships. Vickers Shipbuilding had quietly been preparing its yards for just such an effort. Everything was in place and awaiting approval when “the word” came down from the Council mandating a proven design. Not to worry, though. Thanks to Chausser the only thing “proven” about the *Horizon* and *Archon* classes was their exterior appearance. Everything under those *Daedalus*-style hull plates was state-of-the-art, with that all-important trititanium frame being the key factor. Hopefully this helps explain what’s about to happen to the *Horizon* class cruiser *Constellation* once the next century rolls over. As to why they didn’t go ahead with the

“Galileo” style saucer from the 2150s design study ... well, it would have probably given away their hand. Besides, they already had *another* primary hull design in the works, with an eye towards fitting it on a *Horizon*, and ... well, I’m getting ahead of myself, aren’t I? Best save the tale of the “*Connie*” for the next issue.

The worst is over, folks. Beginning with the next volume we’ll be moving into “established” *STAR TREK* history, and I know a lot of you have been waiting for that. All the background work is effectively over. The last four volumes of the *Federation Spaceflight Chronology* are dedicated to the “known pre-TOS” era, as well as all of those TOS/TAS and movie-era starships that we’ve come to know and love.

Until then,

- Richard.



The surface of UFC 522-IV

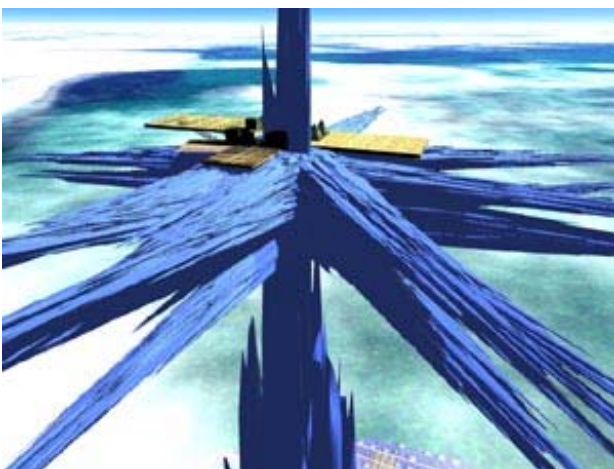

The Crystal Tower of UFC 522-IV

And now, for those of you who didn’t spot them, here are all of the major “in-jokes” and asides that I put in this volume of the *FSC*.

- 1) “Admiral William van Anling” held the rank of Commodore when he assigned Robert April as first captain of the starship *Enterprise* per *Star Trek Log 10* by Alan Dean Foster.
- 2) Two of the “personal starship” images are revised versions of the AMT *Leif Ericsson* shuttle, as redesigned and rendered by Paul Lloyd.
- 3) The “classis starship” pictured in the discussion of the classic starships market is a 3D model of a Swift explorer vehicle from *Space:1999*, as available for download from the OrbiterMods web site.
- 4) The image of the Hourglass Nebula used for the Worlds in Evolution timeline entry should be familiar to Captain Harlock fans from its use in the *Endless Odyssey* OVA series.
- 5) The “Federation police ship” is actually a Cyberman cruiser from *Doctor Who*, as rendered by Maeteen Greenway. If you’ll go to Maeteen’s web site and look at the original full-sized version, you’ll see that the black square on its aft triangular section is actually the logo of the Cybermen, as seen in the *Doctor Who* episode “The Tomb of the Cybermen.”
- 6) The “civilian transport” on the left bottom of the page at the end of the timeline section is the *Firefly* from the series of the same name. Several of *Star Trek*’s graphic designers worked on both shows.
- 7) The Denevan “experimental materializer” is actually David Klein’s 3D render of the USAF time machine from the old Irwin Allen sci-fi TV series *The Time Tunnel*. It seemed appropriate and “looked” right for the early “materializer” I was trying to depict.
- 8) The name of the *Tetsujin* class ringship is an homage to the classic anime TV series *Tetsujin 28*, aka *Gigantor*.
- 9) Admiral Thronlev’s model of the never built NX-Project is ... well, *you know*. -_-^
- 10) Yes, Judge “Marla Rhue” is a nod at actress Madlyn Rhue, who played Lt. Marla McGivers in the TOS episode “Space Seed.” Many of you may be unaware of the fact that she suffered from multiple sclerosis in later years, limiting her acting to sitting parts. I remember seeing her several times playing a judge on *Murder, She Wrote* before her death in 2003. Since Ms. Rhue has always been a fan fave, I wanted to see if I could sneak her back in again.

SPECIAL THANKS TO:

Steve Baron
Jason Boguess
Stan and Fred Goldstein
Todd Guenther
Greg Jein
Michael Okuda
Neale Pearson
Timo Saloniemi
Aridas Sofia

IMAGE SOURCES:

3D Starships
Randy Asplund
Steve Baron (Vintage Starships)
Adam Burch
Var Cauist
Ted W. Geibel
Maeteen Greenway
The *Klingon Academy* Message Forum
David Klein
Paramount Pictures
Paul Lloyd
Starship Modeler
Michael Newlyn
"The Red Admiral"
Sean Robertson
Rick Sternbach
The Trek BBS
Trekmania
Allen B. Ury

SCHEMATIC SOURCES:

Federation Reference Series Online
Neale Davidson
Lawrence Miller
Starfleet Schematic Database
Rick Sternbach
Vintage Starships / Morena Shipyards

YOUR HELP IS NEEDED!

I'm looking for some schematic and 3D/mesh artists to do spacecraft for future issues of the *Federation Spaceflight Chronology*. Want to contribute? Then drop me a line!

rtrodude@cox.net

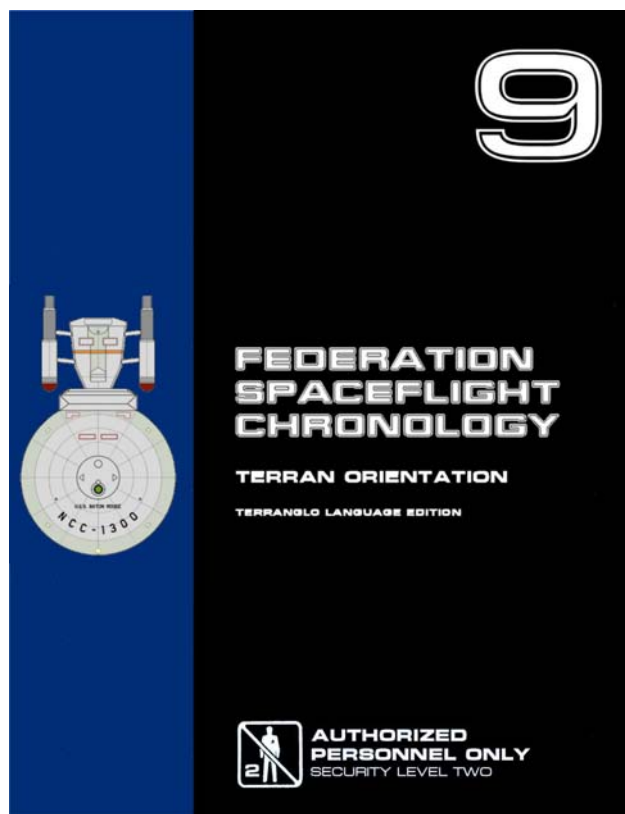

coming soon



under development

