

**FIRST REVISED EDITION
PRIME ONE TIMELINE
[MODIFIED GRAHAM/MANDEL]**

5

**FEDERATION
SPACEFLIGHT
CHRONOLOGY**

TERRAN ORIENTATION

TERRANGO LANGUAGE EDITION



**AUTHORIZED
PERSONNEL ONLY**
SECURITY LEVEL TWO

Original texts and manuscript concept copyright © 2007 by Richard E. Mandel

STAR TREK, its on-screen derivatives, and all associated materials are the property of Paramount Pictures Corporation. Multiple references in this document are given under the terms of fair use with regard to international copyright and trademark law. This is a scholarly reference work intended to explain the background and historical aspects of *STAR TREK* and its spacecraft technology and is not sponsored, approved, or authorized by Paramount Pictures and its affiliated licensees.

All visual materials included herein is protected by either implied or statutory copyright and are reproduced either with the permission of the copyright holder or under the terms of fair use as defined under current international copyright law.

All visual materials used in this work without clearance were obtained from public sources through public means and were believed to be in the public domain or available for inclusion via the fair use doctrine at the time of printing.

Background art courtesy of the SpaceArt Archives
Author of *Valiant* 3D model unknown

This work is dedicated to Geoffery Mandel, who started it for all of us.

Memory Alpha and SFHQ/Mastercom cataloging data:
UFP/SFD DTA HR:217622

PART FIVE

2065-2100: JOINING THE LOCAL GROUP

OVERVIEW

TIMELINE OF EVENTS

TERRAN STARSHIPS

KELDYSH CLASS SURVEY CRUISER
TERRA SERIES SPACE ARK
CONESTOGA CLASS COLONIZER
MERCHANT CLASS CARGO HAULER
MESSIER CLASS CRUISER
COCHRANE INTERSTELLAR EXPRESS
FRANKLIN CLASS SCOUT
COSMOS CLASS SCOUT
DY-1000 SERIES (*EDISON* CLASS)
DY-900 SERIES (*ASGARD* CLASS)

ALIEN STARSHIPS

VULCAN SURVEY CRUISER
DJARTANNA CLASS CRUISER
TELLARITE SPACE ARK *GARTOV*
ANDORIAN BATTLECRUISER

ALIEN ENCOUNTERS

THE VULCANS
THE KAFERIANS
THE TELLARITES
THE ANDORIANS

TERRAN EXPLORATIONS

VULCAN (40 ERIDANI A)
KAFERIA (TAU CETI III)
TELLAR (61 CYGNI)
ANDOR (EPSILON INDIU VIII)
VEGA IX

HISTORICAL ARTICLES

STUDY PROVES REAL ALIENS DON'T EXIST
AMITY RESCUES NEW ALIENS
REAL ALIENS FOUND
LAST SPACE ARK LEAVES SOL SYSTEM
VALIANT MISSING, FEARED LOST
STANDOFF IN SPACE RESOLVED
SPACE LANE NETWORK ESTABLISHED
SUBSPACE RADIO A REALITY
THE WONDERS OF RIGEL
FIRST EARTH-ALIEN CREWS

SCHEMATICS

ACKNOWLEDGEMENTS



Meteor strike, North Sea of Kaferia (2070)

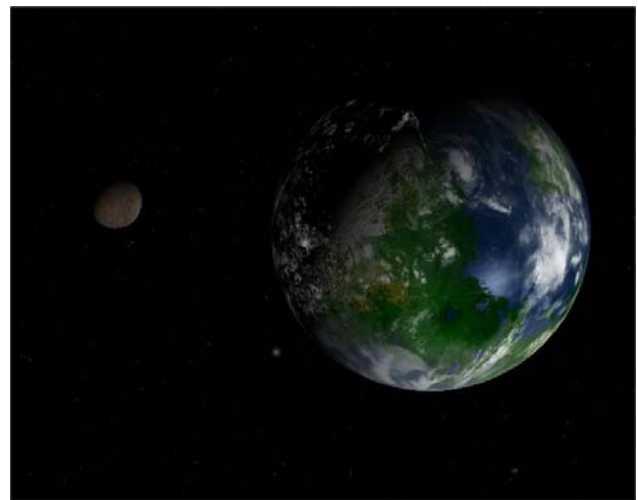

Tellar Prime (2073)



Exploring an alien world (2075)

2066-2100: Joining the Local Group



Warp drive is a rare example of a technology that takes vast amounts of resources and time to develop, but then immediately offers total compensation for the effort. Vulcans have once calculated that a culture will either initiate a massive exploration and colonization program within 50 years of the invention, thus beginning the inevitable arc of galactic conquest, later complacency, and final fall to complete oblivion; or then it will hesitate with using the warp drive, and stagnate completely until awakened by warp-borne visitors. In the rare case it meets an aggressive neighbor in near-equal terms, it may also become a single-planet military power bent on isolationism and highly proficient in achieving that goal.

Earth seems a type A1 example of the first path. Despite the wounds of its recent wars, the planet sent out more than 50 warp-powered ships within ten years of Cochrane's flight. Within 30 years, more than 5000 vessels had left for parts unknown, and six colonies had been founded on empty Class M worlds. One of these was lost soon thereafter, but it did not deter the other hopefuls in the slightest. In comparison, none of the other warp-capable cultures were expanding into Earth's immediate vicinity. The earliest years of the UESF thus represent a rare opportunity to observe a space navy evolving in a power vacuum, unhindered and uninspired by external threats. Whatever hindrance or inspiration Earth's

Vulcan protectors provided remains a matter of some disagreement even after several centuries of study.

The Terran vessels developed during this time are in many ways exceptional for an ascending interstellar power. Races beginning their star travel amidst other FTL cultures are often forced to accept an excessively military posture to survive in the competitive environment, and this normally limits the experimentation done on high speed and long range propulsion, as well as curtailing exploration programs. The basic design of these vessels in turn places great importance on these very aspects, while featuring very limited offensive and defensive armament. The ubiquitous 'boomer ship' of the 2090s-2140s is a remarkable exception from galactic norm, a design sacrificing everything else for the superior ability to engage in interstellar trade. The conscious choice of UESF to dedicate major resources to aiding in the creation of this nonmilitary fleet is an equally unique sacrifice in galactic history, at least among those cultures that have survived beyond their first century in space.

Timo Saloniemi
Hobbyist's Guide to the UFP Star Fleet

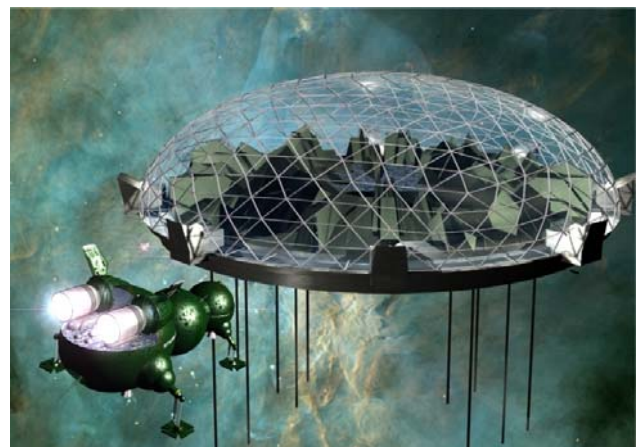

TIMELINE OF EVENTS

2065

- The Treaty of Sirius ends the Earth-Kzin Wars.
- Sirius IX, site of the signing of the Treaty of Sirius, is colonized. This is mankind's first official space colony outside of his own interstellar sphere of influence.

- A disabled Vulcan starship is chanced upon by the Terran survey cruiser *Amity*. Its crew is rescued and brought back to the Sol System to recuperate before being returned to their homeworld of Vulcan. This is humanity's first official contact with the Vulcans.



- In a parallel first contact event a *Franklin* series probe comes across a Vulcan colony world. The Vulcan colonists send the probe back with a message inviting humanity to visit both them and their homeworld.
- The starship *Cochrane* is the first human vessel ever to visit the planet Vulcan.
- Humanity's behavior during the Earth-Kzin Wars has convinced the Vulcans that they are a noble species, despite their emotionalism, and worthy of their benevolence. They will become the greatest allies of humanity during this time, helping introduce it to the other major Local Group cultures and disarming any potential conflicts that may arise. One of the first technological exchanges between humanity and the Vulcans results in improved warp drive engines
- The starship *Bonaventure* leaves the Sol System on its first real interstellar voyage. What was to be a five-year mission exploring the outer Local Group star systems turns instead into a nine-year mission of discovery. It is the first of many exploration ships that will follow in its wake.

- The galactic survey cruiser *Valiant* leaves the Local Group on a mission "to the edge of the galaxy," attempting to determine the ultimate fate of the missing spaceship *Courageous* and its crew. It departs upward from the plane of the ecliptic, following the last known course of the *Courageous* before all contact was lost.



- The galactic survey cruiser *Defiant* leaves the Local group in like manner as its sister ship *Valiant*. In the case of the *Defiant* it is headed downward from the plane of the ecliptic.

- The nickname "torpedoes" becomes common for starship missiles around this time.

2066

- The planet of Kaferia (Tau Ceti system) is the first of the Vulcan-suggested worlds in the Local Group visited by humanity. It is also the first with insect-derived intelligent life. First contact goes better than expected and the Kaferians eventually invite humanity to establish a colony on their world.



- The postwar Cold Peace falls on Terra, inhibiting moves towards a one-world government.
- The *Defiant* is destroyed by a previously unknown alien power. It will take over two decades for its distress call to reach the nearest Local Group star system.

2067

- The UESPA advanced space probe *Friendship One* is launched.
- The first of fifteen *Terra* series space arks is built and launched. This marks the beginning of Terra's Second Great Space Rush (2067-2088). A large number of Terran colonization efforts are directed towards the Ficus Sector and other regions of space deemed potentially compatible with human life forms.
- The *Valiant* is caught in a spatial fold within an ion storm that hurtles it millions of light-years within seconds. It re-emerges only two years away from the galactic rim, well beyond the range of communications with the Local Group

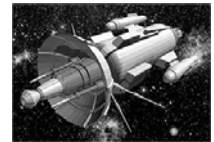

2068

- Formal diplomatic relations are established between humanity and the Vulcans
- The Vulcans are the first to suggest a major interstellar alliance among the major powers of the Local Group. Mankind, with the memories of the Earth-Kzin Wars still fresh in its mind, is eager to take up the suggestion. Nothing comes of this at the time because humanity is not yet ready for such an alliance. It will have to stabilize its government, then meet and become friendly with the other major powers before this can happen. The Vulcans offer their support in this effort.

2069

- The 100th anniversary of the first manned landing on Luna is celebrated.
- The *Valiant* is lost “at the edge of the galaxy.”
- The massive Martian Colonies Spaceyards and Orbital Complex are formally reorganized and renamed as the Utopia Planitia Shipyards.



2070

- As a direct result of the encounter with the Kaferians, the authors of UESPA's Xenobiological Probability Study are laughed out of the organization.
- No trace is found of the *Botany Bay* by UESPA ships along the route to Tau Ceti. The common theory is that it was hit by a rogue meteor and knocked off course. The odds of finding Khan and his escaped Eugenics War supermen now make the proposition a practical impossibility.
- The first attempt to build a working transporter is deemed a failure. Its inventor, Colin Blakeney, is lost under mysterious circumstances. His disappearance sets back research into transporter technology for decades to come.

2071

- The first working subspace radio transmitter, based on Vulcan research and technology, is built. This will free mankind's reliance on geon holes as a means of communications, although geon hole technology is retained as a fallback measure. The domain of geon hole communications will eventually pass to the civilian sector (hobbyists in particular) as subspace radio becomes more powerful and reliable.
- The galactic survey cruiser *Valiant* is officially declared “missing, presumed lost” by UESPA.
- An interstellar trade pact is signed by representatives of the Sol System (Terra), Alpha Centauri (Toliman), and 40 Eridani (Vulcan), and includes their respective space colonies as well. Some historians see this as the first real step on the long road leading to the founding of the Federation.
- One of the immediate outcomes of this trade agreement is the initial definition of major space lanes and trading routes. This will form a series of trade corridors that in time becomes the backbone of the Federation's own space lane network. Almost all of these early space lanes and trade routes remain in use today.
- The Terran interstellar MultiDock enters service. 115 of these will eventually be built with the support of



Terra's new allies. They will be placed along major space routes and at strategic points within the Local Group. This is the forerunner of the Federation's Starbase and Deep Space Station networks.

- Terra sends its first manned expedition to Europa since the loss of the *Nautilus*.
- *The Wanderer*, a former L-5 space city, becomes mankind's largest-ever spacecraft after it is modified with fusion drives by its inhabitants and rockets out of the Sol System.

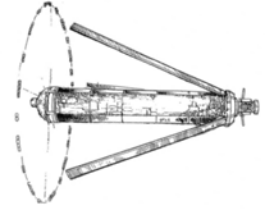

2072

- The last of *Terra* series space arks is launched.
- The *Merchant* class explorers enter service.
- Terra abandons Intersat code for interstellar communications.

2073

- The space buoy marker system comes into being. They are deployed to mark the first commercial spacelane network (as defined by the 2071 treaty).
- The first subspace relays are deployed.
- First contact is made with the Tellarites.
- The last of the *Glenn* class space buses is retired.
- The planet Hera is colonized by the last known survivors from the losing side of the Eugenics Wars.

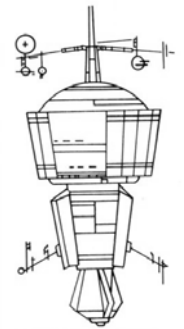

2074

- The Cochrane Interstellar Express (CIE-07) starships enter service. These are the first starships designed for use by the civilian sector and the last ever built by Cochrane Warp Dynamics. After this the company abandons starship design to focus more on warp drive development and production.
- The first test of the new Local Group subspace radio network is successful, with messages being relayed at 64 times the speed of light.
- The *Bonaventure* arrives at Alpha Centauri, having successfully completed its first interstellar voyage. It brings back a wealth of information on worlds within the Local Group. A second voyage is commissioned as soon as the ship is refurbished and upgraded. This process will take almost six years to complete due to rapid advances in starship technology since the *Bonaventure's* was first launched.



2075

- The *Franklin* class scout enters service (not to be confused with the *Franklin* automated probe).
- Around this time, many Terran pre-warp interstellar starships are either converted to warp drive or retired from service as more warp-based designs become available. The starship *Icarus*, the lone survivor of its class, is retired rather than converted. Its unique design makes it a poor candidate for a full warp drive conversion. Most of these retired pre-warp starships eventually find their way to the civilian sector, where they will labor on for decades (and centuries) to come.
- First contact with the Andorians almost ends in disaster when they attack the UESPA vessel visiting their world.

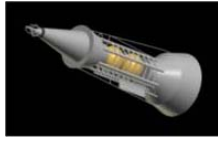

2076

- The *Aquarius* class automated bulk transports enter service. They will become a familiar sight on the Local Group's space lane network, transporting raw materials and bulk goods from one star system to another.

2077

- The Vulcans intervene to prevent a new interstellar war between Terra and Andor. Their logic to the Andorians is that Terra was the power behind the defeat of the Kzinti Empire. They are a species worth knowing, not fighting, and Andor would better be served as their ally instead of their enemy. Andor and Terra will eventually become strong allies despite this initial rocky start, just as the Vulcans have predicted.
- The *Parr* class transports are retired.

2078

- The *Messier* class cruisers enter service. This is the last major Terran starship class and the last whose components are manufactured exclusively within the Sol System.
- Birth of Harmon Axelrod, first president of the Federation.
- As of this date there are 33 self-sufficient human colonies on 10 extraterrestrial worlds.
- The *Wayne* class scouts are decommissioned.
- Groxing xenophobia against "alien influences" in certain parts of the world disrupts the increasingly impotent New United Nations. The warlords of the devastated zones in Asia and Europe begin to fight among themselves, bringing about the Warlord War.



2079

- As the rest of Terra watches in horror, atomic weapons are employed as the last remaining factions from the Post Atomic Horror effectively exterminate each other in the short-lived Warlord War. This marks the last use of atomic weapons on Earth.
- The surviving elements of the United States, Canada, Mexico, and the Caribbean islands band together to form the United States of North America.
- The Pacific League of States is formed around this time.
- Humanity visits the Rigel system for the first time after hearing of their existence from the Tellarites. The starship *Marco Polo*, a visiting Terran vessel, also has mankind's its first encounter with Rigel's Orion colonies. Their trade goods and technology are discovered to be far in advance of anything that the system currently has to offer in exchange. Nonetheless, Orion merchants plan to "invade" this new market as soon as possible, offering their system's plentiful raw materials in exchange for Local Group merchandise.
- A temporary hiatus, lasting only a few years, occurs in Terran interstellar exploration. This is partly due to government reluctance and partly due to the culture shock resulting from the encounter with the Orion colonies, where slavery of Orion females is not only permitted but officially endorsed by the government.
- The WP174 work pods enter service.
- All save the class ship of the *Magellan* class spaceliners are withdrawn from service.

2080

- The *Companion* class cruisers are decommissioned save for the *Fisher*. It is converted to a diplomatic cruiser for use by diplomats and officials of the New United Nations.
- Zephram Cochrane leaves Alpha Centauri and relocates to Terra, where he works at Princeton-Pennsylvania as a professor for a time.
- The European Hegemony forms around this time.
- The surviving African nations band together to form the United States of Africa.
- The Russian Federation forms around this time.
- The newly refurbished and rechristened starship *Bonaventure* leaves Alpha Centauri on its second major interstellar voyage. This time its mission is to the systems in former Kzinti space beyond the Local Group.
- By this point humanity has a number of thriving space colonies both within the Local Group and beyond. Far many more colonization attempts have failed or disappeared without a trace.



2081

- The first of the *Quantum* (aka *Milky Way*) series of deep space probes, jointly developed by humans and Vulcans, is launched.

2082

- Now that the major powers of the Local Group are finally acquainted and at peace with each other, the Vulcans once again raise the idea of a formal interstellar alliance. They sponsor a conference on the subject. The move fails to receive popular support because its primary goals and policies are not adequately defined. The Vulcans resolve to try again at a later date. In the meantime the attending diplomats agree to work together to better define the roles and responsibilities of the new government.
- The *Cosmos* class survey ships enter service.
- The first major incident with the Kzinti since the end of the Earth-Kzin Wars takes place. They attempt to capture the *Bonaventure* in order to gain the secrets of warp drive. Star Fleet comes to the rescue; however, the *Bonaventure* is so heavily damaged in the encounter that its second voyage comes to a premature end. It is subsequently towed back to the Sol System and repaired sufficiently for public display as man's first true starship. It will remain a museum ship for almost a century.
- Problems encountered in towing the *Bonaventure* back to the Local Group will result in the production of the *Assist* class starships.



2083

- The UESF cruiser *Pollux* becomes the first Terran starship with an alien crewmember. Its communications officer is a Vulcan.
- The last of the war-era *Keller* class space ambulances are decommissioned.
- The Andorians are the next of the major Local Group powers to achieve faster-than-light travel. The other powers within the Local Group have only minimal input in this effort per the wishes of the Andorians. Their cultural pride dictates that they be recognized for their own accomplishments rather than accept the charity of others.

2084

- The Ceres Expedition, an early colonization effort to the Ceres Sector, is lost. Their descendants will be rediscovered decades later on Capella IV.

- The lone ship of the DY-1000 series, also known as the *Edison* class, enters service. It is a colossal failure due to inadequate shielding and sub-par warp performance. Dyson-Yoyodyne goes bankrupt and passes into receivership as a result of this debacle, marking the end of an era in Terran spacecraft design.



2085

- A previously unknown disease contracted from an unscrupulous Orion trader wipes out the entire staff of the Pluto Research Base. The trader flees for his life and escapes back to the Orion colonies, where he escapes prosecution by Terran authorities. This unpleasant incident sets the tone for future Terran-Orion relations.
- The *Assist* class starships enter service. These are "space tugs" designed to tow damaged or disabled starships at warp speed back to the nearest base or planet for repair.

2086

- The first Andorian starships with warp drive begin operating within the Local Group.
- The *Verne* class starship *Fletcher* explodes in near-Earth orbit after a catastrophic warp drive failure within Earth's gravity well. The subsequent investigation determines that its unusual warp field created by its triple-engine arrangement was probably responsible for the failure. This is the first hard evidence of the difficulties in maintaining a stable warp field with an odd number of engine nacelles, given the limitations in starship technology at the time. It is the only black mark in the otherwise excellent service record of the *Verne* class.
- The loss of the *Fletcher* marks the beginning of the rise of the fortunes of Cochrane Warp Dynamics, as its warp engine technology has proven to be more stable than current Terran designs. Most Terran warp drive manufacturers will go bust or change business venues by the end of the century.

2087

- Vulcan sponsors the first of the Babel Interplanetary Conferences is held. These will become annual events, designed to allow the Local Group systems to peacefully resolve their disputes without resorting to warfare.
- The Coalition of Planets is founded as a loose alliance among the major and allied systems of the Local Group during this year's Babel Conference. This is the forerunner of the Federation as we know it today.
- All members of the Coalition of Planets consent to Terra taking on the lion's share of Coalition space exploration and defense. Terra's United Earth Star Fleet is named as the Coalition's official space defense agency. UESPA is named as its official science and exploration agency. Coalition members begin coordinating many of their own space defense and exploration efforts through Star Fleet and UESPA after this point.

NOTE: From this point on the term *Star Fleet* will be used in place of the acronym UESF in light of its new role with the Coalition of Planets.

2088-2094

- The War with the Vegan Tyranny

2089

- Another Vegan ship is encountered, the first since the end of the Earth-Kzin Wars. It fires on a Terran ship and the Terran ship returns fire, disabling it. The Vegan ship self-destructs before it can be seized. This marks the beginning of the War with the Vegan Tyranny.
- The War with the Vegan Tyranny marks Star Fleet's first real test as the defensive arm of the Coalition.
- The decisive actions of the Star Fleet starships *Krushchev* and *Cochrane* prevent the War with the Vegan Tyranny from escalating into a major interstellar conflict.
- The British royal family surrenders Buckingham Palace and many of their other royal estates to a public trust and move into more modest lodgings. They still continue in their ceremonial roles per the wishes of their subjects, however. Buckingham Palace is eventually turned into a museum.

2090

- A joint Star Fleet/Tellarite/Andorian operation defeats the Vegans in one of the major battles of the War with the Vegan Tyranny.
- The first of Vega's slave planets is freed by Star Fleet.
- The *Monticello* class transports are decommissioned.

- A second Kzinti "incident" is nipped in the bud when their ships run afoul of a squadron of *Messier* class cruisers engaged in battle with Vegan craft. Both sides break off the engagement to destroy their mutual enemy, the Kzinti. The two sides then leave the field of battle and conflict with the Vegans ends for a brief time. This will be the last Kzinti attempt to break the confines of the Treaty of Sirius in this century. The incident is considered a victory by Star Fleet and helps increase their prestige with the public.

2092

- A trade corridor is established between Rigel and the Local Group. Soon, Orion traders and merchants will be a common sight among Local Group systems. The practice of selling Orion's "green animal women" as slaves will be forbidden by local laws, although many such purchases will be made in secret.
- A new DY-245 "revival series" is launched by what  remains of the Dyson-Yoyodyne consortium, which is still recovering from bankruptcy. A slight reworking of the classic DY-245 design with modern technology, these reproductions are the most affordable DY-series to date. Their low-cost jump drives makes the revival DY-245s the fastest DY-series ships of their time. Brisk sales among the denizens of the Terran asteroid belt help Dyson-Yoyodyne emerge from receivership within a few years. As a result of this success the new Dyson-Yoyodyne will limit future development of new ships types, focusing its efforts instead on the rapidly growing "classic starships" market.

2093

- Star Fleet learns that the Vegans are suffering from an extremely virulent disease, *vegan choriomeningitis*, which they call "the Green Death" and which will kill what are few of them are left in short order.
- The Vegans refuse Star Fleet's offer to help them overcome the "Green Death" afflicting them. The xenophobic Vegans opt for racial suicide instead. The War with the Vegan Tyranny ends the following year with the deaths of the last Vegans.
- The last of the *Liberty* class cruisers are decommissioned.

2094

- First contact with the Deltans at their new colony on Vega IX.
- Star Fleet's attempt to seize Vega IX (and any Vegan technological secrets it might hold) "for the safety of the Coalition" so outrages its members that a Babel Conference has to be called to resolve the situation.
- One of the clauses of the Treaty of Vega IX, enacted during the emergency Babel Conference, guarantees

the multiethnic, multispecies makeup of Star Fleet. It will be the basis for a similar clause in Star Fleet's new charter at the founding of the Federation.

- The New United Nations is formally dissolved. In its place arises the United Earth Organization. Its function is much like that of the old United Nations in that it is a central organization for the nations of Terra to peacefully resolve disputes and work out common trade and cultural agreements. This is the precursor of the United Earth Government as we know it today.

2095

- The last of the *Verne* class cruisers are decommissioned.
- The *Franklin* class scouts are decommissioned.

2096

- The Local Group's subspace radio network undergoes its first major expansion, linking many new colonies into its regular transmission network.
- A freighter operating on the far fringes of known space picks up a faint distress call from the lost starship *Defiant*. The ultimate fate of the lost starship is now known, although the reasons behind it remain a mystery.

2097

- The groundwork for the successor to the Coalition of Planets is laid out at a diplomatic conference on Terra at San Francisco.

2098

- The last of the Series A Terran Multi-Docks ends its service life. These are replaced by the Series B Multi-Dock.

2100

- The DY-900 *Asgard* series is Dyson-Yoyodine's first all-new starship design since its recovery from bankruptcy. It also marks something of a break from the company's traditional "space submarine" spacecraft designs.
- The Century Conference on Terra looks back at the advances of its past 100 years and forward to what the next 100 years will bring.
- The European Hegemony sponsors moves to transform the United Earth Organization into a true one-world government. Radical conservative elements within the United States of North America and Australia will resist as long as they possibly can; however, one-world government is inevitable on Terra.

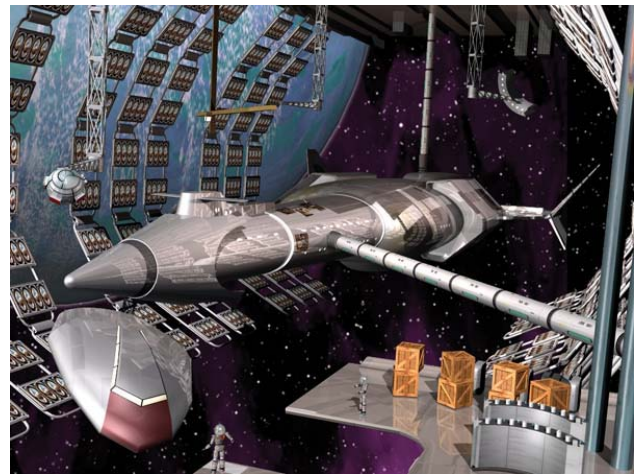

UESF DY-X cruiser nearing completion (2065)



UESPA's revised logo (c.2067)



Terra's last atomic explosion (2079)

TERRAN STARSHIPS

KELDYSH CLASS SURVEY CRUISER

SERVICE ENTRY DATE (OLD CALENDAR): 2064

The *Keldysh* class survey cruiser was Zephram Cochrane’s first major peacetime starship design to be built. The intent was for these ships to undertake the first surveys for UESPA of the holdings of the former Kzinti empire beyond Local Group space. The lead ship, *Keldysh*, had been converted from the wrecked hull of the wartime prototype battlecruiser *Seneca*. They performed admirably as survey cruisers despite their rather ungainly looking design. Its boom-mounted circumferential warp engine arrangement was copied directly from Cochrane’s own warp drive prototype. This would prove to be the herald of things to come. The class remained in service, with periodic upgrades and swapping of old engines for new, until 2130.

The most notable member of the class, the *Valiant*, was lost in the upper quadrants of known space near the edge of the galaxy. It had been following the projected route of the Terran spaceship *Courageous*, lost almost four decades earlier, in an effort to determine what had happened to the ship and its crew. The ultimate fate of the *Valiant* would remain a mystery until its recorder-marker was found by the starship *Enterprise* in 2261.

SPECIFICATIONS:

Length:	97 m
Beam:	38 m
Draft:	19 m
Mass:	6,800 DWT
Crew	80
Range:	5 years at L.Y.V.
Cruising speed:	Warp 2.05
Maximum safe speed:	Warp 2.10
Armament:	2 laser cannon 8 fusion missiles

Innovations:

- First starship class built after the Earth-Kzin Wars
- First starship with twin boom warp drive arrangement

VISUAL:

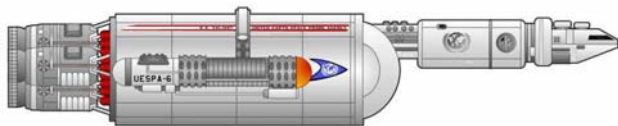

STARSHIP VALIANT CONCEPT BY GREG JEIN AND MIKE OKUDA
SCHEMATIC COURTESY OF THE DAYSTROM TECHNICAL INSTITUTE

TERRA SERIES SPACE ARK

SERVICE ENTRY DATE (OLD CALENDAR): 2067

The Space Arks started out life as a series of massive mobile industrial refineries intended for raw materials extraction just beyond the Solar System. Their rugged construction was due both to the ongoing Earth-Kzin Wars and the fact that they were to spend most of their time operating in the Kuiper Belt and Oort Cloud zones. Their massive design and industrial origins precluded the use of jump or warp drive; instead, a series of four fusion reactors powered a common large impulse drive system that could achieve a cruising speed of 0.5c. The end of the war brought an end to the need for these vessels, so seventeen hulls in various states of completion were sold off to the highest bidder. Hulls 1-10 and 15, which were over 50% complete, were eagerly snapped up by private colonization consortiums. These were looking for ready-made or near-ready ships that could be adapted for long-range interstellar voyages. The others (11-14) were scrapped for salvage. The fact that these were sublight vessels mattered little to the colonists, who were planning for multigenerational voyages anyway. All but the last two, *Terra 10* and *Terra 15*, would never reach their destinations, falling prey to various dangers en route.

SPECIFICATIONS:

Length:	306 m
Diameter:	140 m
Mass:	34,600 DWT
Crew	variable
Range:	at least 50 light-years at 0.5c
Cruising speed:	0.5c

VISUAL:

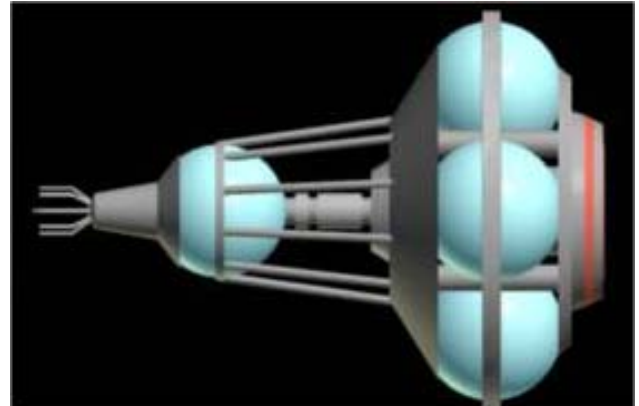

TERRA CLASS SPACE ARK BY RICK STERNBACH
AS RENDERED BY STEVE BARON

CONESTOGA CLASS COLONY SHIP

SERVICE ENTRY DATE (OLD CALENDAR): 2069

These were the first purpose-built Terran colonization craft capable of warp speed. The design was fairly simple, in essence a warp engine frame built around a colonization cubicle designed for re-entry and landing on a hard planetary surface. Such landings were always permanent. *Conestogas* had to jettison its warp engines as part of the atmospheric entry procedure, and the onboard fusion reactors for powering ship's systems (and the planned colony) were insufficient to lift it back off again. Provided a successful landing had been achieved, the crew would then revive the colonists (suspended in cryosleep chambers) and unseal the cargo holds, which held all of the gear necessary to establish the new colony. Strictly speaking, this made a trip aboard a *Conestoga* a one-way proposition but one that its passengers eagerly accepted, risking their lives in order to establish new homes on a previously unknown world. Five of six *Conestoga* missions would ultimately prove successful, with the Terran colony of Ophiucus being the most notable. The design was withdrawn from production in 2080, by which time more advanced designs had replaced the *Conestoga* in the colonization role. The remaining unused ships in the class were reconfigured for use as transports and so served until withdrawn from service in 2098.

SPECIFICATIONS:

Length: 197.2 m
Beam: 71.0 m
Draft: 34.9 m
Mass: 23,800 DWT
Crew 25 (+200 colonists in cryosleep)
Range: 10 years at L.Y.V.
Cruising speed: Warp 1.6
Maximum speed: Warp 2.0
Armament: none

VISUAL:



CONESTOGA DESIGNED BY GREG JEIN

MERCHANT CLASS CARGO HAULER

SERVICE ENTRY DATE (OLD CALENDAR): 2072

The *Merchant* class has the unenviable reputation of being one of the ugliest Terran starships ever to see service. It was nothing more than a basic frame with an unlicensed copy of a Utopia Planitia command module mounted on one end and a stripped-down GSC-1600 warp engine assembly on the other. The frame itself provided a central anchor for almost every kind of cargo module used by humanity from the old DY-series of the late 1990s up to the current Star Fleet models of the day. It was not designed for beauty, however. It was a cheaply built civilian interstellar trader, pure and simple. As might be expected Utopia Planitia promptly filed a lawsuit over the original command module design, eventually forcing a different design to be installed on later ships in the class.

The *Merchant* class would have been forgotten had it not been for the *Marco Polo*, the only starship of its class to ever achieve fame. The *Marco Polo*, under the command of Lorenzo Malfatti, was the first Terran starship to visit the Rigel System and its Orion colonies. As ungainly and ungraceful as it was, both it and its crew displayed a level of knowledge and technology far above what was available in the Rigel system at the time. The *Marco Polo* would return to the local group with eager Orion traders in tow, anxious to take advantage of this previously unknown and untapped market for their own personal gain. Later, near the end of its career, it would discover the interstellar phenomena known today as "Polo's Bolos," twin black holes locked together in a perpetual interstellar wrestling match. The original *Marco Polo*, like the other members of its class, was eventually scrapped; however, its name lives on in each successive generation of Star Fleet survey cruisers.

SPECIFICATIONS:

Length: 42.1 m
Mass: 12,500 DWT
Crew 20
Range: 2 years at LYV
Cruising speed: Warp 2
Armament: 4 forward lasers
(plus various owner modifications)

VISUAL:



MERCHANT MODEL BY GREG JEIN
AS FEATURED IN BACKGROUND SHOTS OF DEEP SPACE NINE
BACKGROUND STORY COURTESY OF FASA CORPORATION

COCHRANE INTERSTELLAR EXPRESS

SERVICE ENTRY DATE (OLD CALENDAR): 2074

Cochrane Warp Dynamics is known today primarily for its warp engine designs. Back in the early days of warp technology, however, they also dabbled in spacecraft construction. In addition to the *Keldysh* class cruisers they also designed the CIE-07, aka “the Cochrane Interstellar Express.”



This was the first warp drive starship manufactured for the general public. The design was based on the first Terran Space Ferry – a lifting body suited for atmospheric take-off and re-entry with minimal assistance. Because of this it could use any large clear strip for takeoff and landing. Former airports and airstrips were popular, with the CIE-07 and other similar designs transforming these into humanity’s first civilian spaceports.

The CIE-07 was the first civilian starship to utilize a dual propulsion system. Like military vessels, it was fitted with both impulse engines and early warp drive. These, however, were on a smaller scale and far less range than standard industrial and military models. The warp drive of a CIE-07 was not that far removed from early “jump drives,” in fact, which helped reduce the overall cost of the design.

Despite its innovations the CIE-07 never made a profit for Cochrane Warp Dynamics. Only 50 were sold in three years before it was withdrawn from production. The company sold the rights to the CIE-07 to Star Fleet in 2105. A modified version was produced for military use, remaining in service until 2143.

ORIGINAL SPECIFICATIONS (2028):

Length: 53.5 m
Beam: 56.3 m
Draft: 18 m
Crew 20
Range: 2 years at L.Y.V.
Cruising speed:Warp 2.8
Maximum safe speed: Warp 3.25

Innovations:

- First mass-produced civilian starship design

VISUAL:



CIE-07 DESIGN BY ROBERT C. DUNEHEW

FRANKLIN CLASS SCOUT

SERVICE ENTRY DATE (OLD CALENDAR): 2075

The *Franklin* class was the last of the “flared arrow” starships. Its origins lie in the spiked antimatter war-era *Orion* class scout. These were built for speed and maneuverability, with intelligence gathering as their primary function. Their unique design heritage precluded easy upgrades and shortened what might have been longer service lives. A few saw service in the early years of the War with the Vegan Tyranny but they were hopelessly outclassed by Vegan ships. The last was retired in 2095.

SPECIFICATIONS:

Length: 45 m
Diameter: 20 m
Mass: 55 DWT
Crew 4
Range: 5 years at L.Y.V.
Maximum safe speed: Warp 2.5
Armament: 4 forward lasers
50 fusion missiles

Innovations:

- Last of the “flared arrow” spiked antimatter starships

VISUAL:

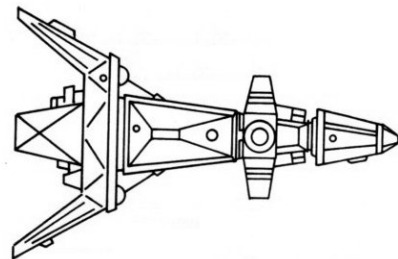

FRANKLIN DESIGNED BY RICK STERNBACH



The L-langon Mountains of Vulcan

MESSIER CLASS CRUISER

SERVICE ENTRY DATE (OLD CALENDAR): 2078

The *Messier* class starships, the most heavily armed starships of their time, were Star Fleet's first major warship class since the end of the Earh-Kzin Wars. Everything save its engines reflected the angular design philosophy prevalent among Terran starship engineers at the time. The engines, however, were provided by Cochrane Warp Dynamics of Alpha Centauri. A total of 28 ships were built between 2078 and 2100, and with periodic refits continued to serve as the backbone of Star Fleet well into the Romulan War era.

This was the first Terran starship to include the new subspace radio. Its only drawback was that it was useless outside of the Local Group subspace net. This drawback was partially offset by the addition of temporary subspace transponders, which it could drop every two light-years outside of Local Group transmitter range as needed.

SPECIFICATIONS:

Length: 258 m
 Beam: 113.8 m
 Draft: 72.1 m
 Mass: 110,00 DWT
 Crew 183
 Range: 4 years at L.Y.V.
 Cruising speed:Warp 2.75
 Maximum safe speed: Warp 2.9
 Armament: 8 laser banks
 2 particle cannon
 55 fusion missiles

Innovations:

- First starship with subspace radio.
- First Star Fleet starship class with integrated crews

VISUAL:



MESSIER DESIGN BY RICK STERNBACH
3D MODEL BY AGATHA CHAMBERLAIN

COSMOS CLASS SCOUT

SERVICE ENTRY DATE (OLD CALENDAR): 2082

The 38 vessels of the *Cosmos* and later *Huey* classes together make up one of the more unusual starships of their era. They were designed from the onset as multi-mission capable. A variety of different sensor pallets, ranging from heavy to light, could be fitted to the ship's cylindrical nose depending on the mission at hand. Most of the time these carried the heavy Explorer sensor pallets for exploration and survey of new star systems from a distance. They entered service just in time for the War with the Vegan Tyranny and often served as intelligence gathering ships. Their most notable accomplishment for UESPA after the war was helping to complete the initial surveys of the New Territories, from which the first navigational charts of the region were made. All were retired by 2120.

SPECIFICATIONS:

Length: 229 m
 Mass: 36,700 DWT
 Crew 100
 Range: ? years at L.Y.V.
 Cruising speed: Warp 2.5
 Armament: 2 forward lasers
 50 fusion-style missiles (*Huey*)

VISUAL:

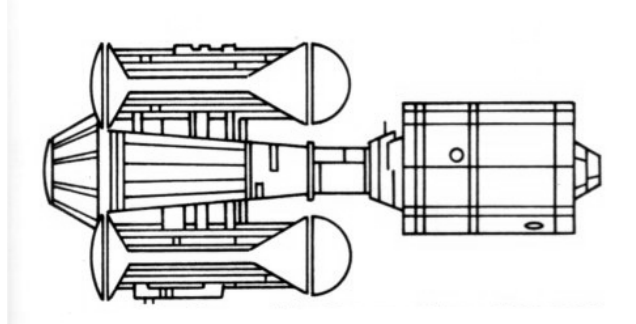

Cosmos class scout

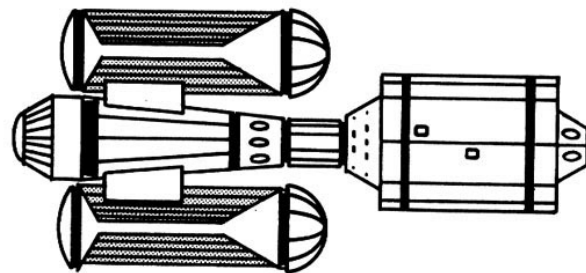

Huey class scout

COSMOS DESIGN BY RICK STERNBACH
HUEY ADAPTATION BY LAWRENCE MILLER

EDISON CLASS CRUISER (DY-1000)

SERVICE ENTRY DATE (OLD CALENDAR): 2084

The DY-1000 *Edison* will forever be known as "the ship that broke Dyson-Yoyodyne." It represented their last, best hope to regain the monopoly they once held on the Terran spacecraft industry. Given the excellence of the competition it is surprising that it would have produced such a subpar design, but that it did. Its fatal flaw was its lack of sufficient meteoroid shielding. The *Edison* was severely damaged by multiple meteoroid strikes while on a test run through the Kuiper Belt and wound up with just over a third of its compartments hulled. Fortunately none of its crew were lost; however, its engine room was among the compartments wrecked by the meteoroids. The disabled ship had to be towed back for major repairs. Dyson Yoyodyne's stock rating fell with each day that it took for the *Edison* to return to the Pluto Test Range. By the time it was berthed and undergoing repairs the company was filing for bankruptcy.



The orphaned *Edison* eventually found a home with UESPA as a science probe training ship. It was also frequently loaned to higher educational institutions for space science excursions across the Sol System. It enjoyed a longer life than it deserved in this new role, finally being retired in 2139. Ironically, it sits in orbit beside the *Tritium* (another notable failure) at the Terran branch of the Federation Air and Space Museum.

SPECIFICATIONS:

Length: 245 m
 Mass: 34,000 DWT
 Crew 58
 Range: interplanetary
 Cruising speed: Warp 1.5
 Armament: none

VISUAL:

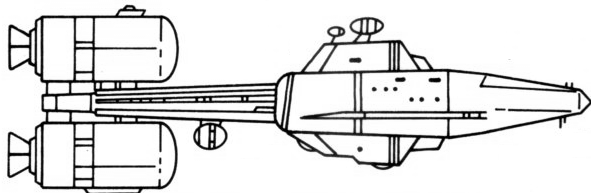

DY-1000 *Edison* (rebuilt configuration)

DY-1000 DESIGN BY RICK STERNBACH
 "ORIGINAL CONFIGURATION" BY LAWRENCE MILLER

ASGARD CLASS TRANSPORT (DY-900)

SERVICE ENTRY DATE (OLD CALENDAR): 2100

The *Asgard* class was Dyson Yoyodyne's first new design since it emerged from receivership in 2092. It was a first for the firm in that it abandoned the company's traditional "submarine" style hull in favor of a more contemporary design. It did tolerably well, given the fact that it was competing in an already crowded market, but the minimal profits that sales brought in were a far cry from what Dyson-Yoyodyne had earned in their heyday. This would eventually wind up becoming one of the last original DY-series designs ever built.



The engine cooling vanes were deleted from later ships in the series as being superfluous. The last DY-900, the *Ghanima*, was completed in 2125.

SPECIFICATIONS:

Length: x m
 Diameter: x m
 Mass: x DWT?
 Crew x?
 Range: x years at L.Y.V.?
 Maximum safe speed: x

Innovations:

- First DY-series spacecraft to depart from the company's traditional "submarine" style hull
- First DY-series design with "true" warp drive.

VISUAL:

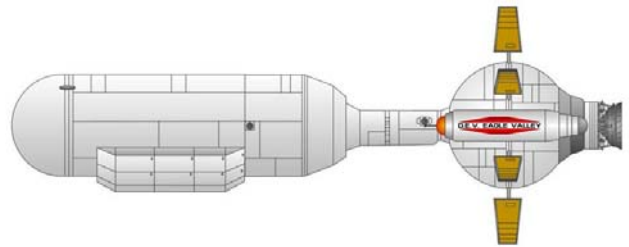

DY-900 DESIGN BY THE JOURNAL FOR APPLIED TREKNOLOGY

ALIEN STARSHIPS

VULCAN SURVEY CRUISER

SR'NARAI CLASS

Vulcan ship designs were unique among Local Group starship designs prior to Terra joining the scene in the 21st century. Their ships were the only warp-capable ones at the time to utilize a toroidal drive system. Terrans quickly dubbed them “ringships” after their own sublight ringship designs, such as the *Declaration* and *Searcher* class. Utopia Planitia would copy aspects of these graceful vessels into its own line of Terran warp drive ringships, most notably the *Valkyrie*, *Bellerophon*, and *Atlas* classes.

The *Sr'narai* is typical of the period. The design was the most advanced starship fielded by a member of the Local Group during this time. Other contemporary Vulcan capital ship designs were merely logical extensions of the basic *Sr'narai* design principles.

VISUAL:

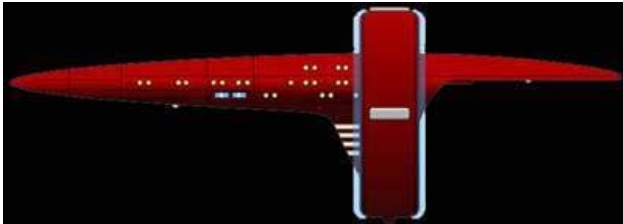

VULCAN SURVEY CRUISER BY DOUG DREXLER
SCHEMATIC COURTESY OF THE DAYSTROM TECHNICAL INSTITUTE

CENTAUREAN CRUISER

DJARTANNA CLASS

The starships of Alpha Centauri followed their own distinct development path apart from that of its brother planet Terra. Thanks largely to the influence of Zephrae Cochrane, Centaurean designs quickly adopted a boom nacelle approach. As with the earlier *Keldysh* class survey cruisers, these typically had two warp engines mounted on booms away from the main body of the ship. This both allowed for the formation of a more stable warp field than contemporary Terran designs and permitted the engines to be jettisoned in case of an emergency. Like the earlier *Keldysh* class, one can see in the *Djartanna* class the faint beginnings of what would eventually become Star Fleet's Class I starships.

The *Djartanna* class starship was the first non-Terran starship design to be incorporated into Star Fleet. It was also the last “local” design produced for Star Fleet before its own dedicated classes entered service. See the Academy Intranet entry for the *Wright* class cruiser for more information.

VISUAL:

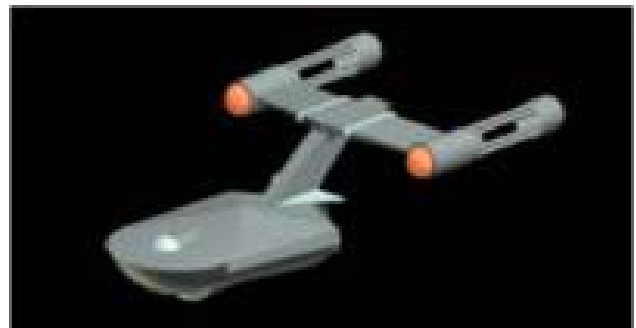

DJARTANNA CLASS COURTESY OF FASA CORPORATION
3D MODEL BY SCOTT BARON

TELLARITE SPACE ARK

GARTOV CLASS

Space arks were the first major class of large-scale interstellar spacecraft constructed by the Tellarites after their civilization had finished recovering from centuries of Kzinti occupation. They literally had to learn starship technology all over again, with their chief scientists either kidnapped or killed by the Kzinti in the dark days of their past. Nevertheless, they approached the problem with all of the resourcefulness that has made Tellarite engineers such a legend. The fact that they were going to have to literally reinvent the interstellar wheel did not stop them from building one of the most truly spectacular sublight spaceships ever conceived.

The *Gartov* (named after the Tellarite monarch at the time) was designed as a colonization ship. Its unusual appearance is part unique design and part homage to Tellarite ingenuity. The *Gartov* never made it to its intended destination, though. It was first encountered by the Terran starship *Bellerphoron* as part of the first contact between these two humanoid species. The *Gartov* is now fixed in orbit around Tellar Prime as a permanent museum ship.

VISUAL:



SPACE ARK *GARTOV* BY ARIDAS SOFIA
MODIFIED BACKSTORY BY RICHARD MANDEL (WITH PERMISSION)

ANDORIAN BATTLECRUISER

NARSH CLASS

It should come as no surprise that a species known for its warlike culture would field a warship as its first major warp-capable starship. The Andorian *Narsh* was the main patrol ship of the 14-world Andorian empire at the time of first contact with humanity. Although its warp drive systems were not as sophisticated as those of human starships of the era it literally bristled with weapons in comparison. Only the *Messier* class cruisers of the Terran Star Fleet were as heavily armed as an Andorian *Narsh* class battlecruiser. This reflected the prevalent Andorian military tactic of responding in strength with overwhelming firepower to any perceived threat. This design philosophy was similar to that of the Klingons, with both cultures fielding comparable armed battlecruiser designs around the same time. One can only speculate as to how any of these might have fared had they met each other in mortal combat.

VISUAL:

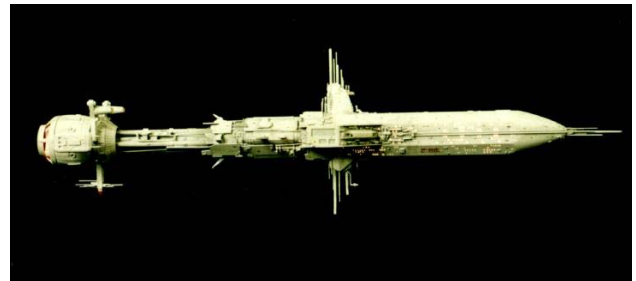

ANDORIAN BATTLECRUISER COURTESY OF THOMAS MODELS

ALIEN ENCOUNTERS

VULCANS

Vulcan's unforgiving climate has molded its people into a peculiar humanoid species with few physical equals in known space. Despite their similar body mass to humans, Vulcans are approximately 3 times stronger and their lifespans tend to average 200 or more years. Their bodies can withstand a range of environmental extremes that would seriously debilitate or even kill a human. They have limited telepathic abilities and their ears are pointed for better hearing in the thin Vulcan atmosphere. Also, despite having a typically humanoid outward appearance, the internal arrangement of Vulcan organs is somewhat different and their blood is copper-based. This gives the skin of most Vulcans its characteristic yellow-green tint. Certain equatorial Vulcan tribes are dark-skinned like their Terran counterparts, though, making this tint almost impossible to discern with the naked eye.

Vulcan ears are pointed in order to better catch sounds in the thin atmosphere of their homeworld. Their hair tends to grow straight and dark, usually black or a rich shade of brown. Red-haired Vulcans are a rarity. No blond-haired Vulcan of natural birth has ever been documented in the 300,000+ history of their people.

Vulcan eyes have a nictating membrane, i.e. "third eyelid," that developed to protect them from the extremes of their homeworld's sun. It is partially because of this that they long ago adopted the custom of sleeping with their eyes open. Their nictating membranes close during normal periods of rest. Vulcans do not normally close their eyes proper for extended periods save when gravely ill or severely injured. As such times they will invoke a self-induced healing trance, shutting down most of their metabolism in order to concentrate their body's resources on healing their affliction. This trance is so deep that it can frequently be mistaken for death without an instrument scan and often requires the attention of a third party to break them out of it.

Vulcans are one of the few known humanoid species with latent telepathic abilities. All Vulcans have a limited telepathic ability from birth and develop the ability to "mind touch" through rigorous training as they grow older. Other, more sophisticated Vulcan techniques include the "mind meld," in which they can share the thoughts of another being and vice versa; and the "mind probe," a drastic technique use only under extreme circumstances to force information from an unwilling subject. Most of the time such techniques require direct physical contact but there are exceptions, such as the long-distance "mind link." Most Vulcans are reluctant to share their telepathic talents outside their species save under exceptional circumstances.

VISUAL:

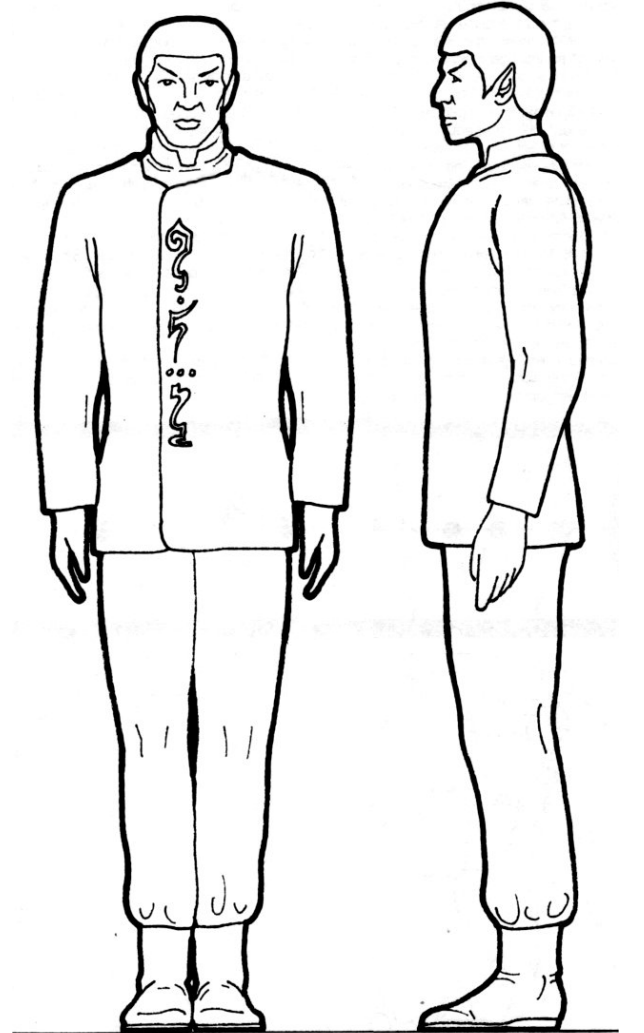

Typical Vulcan male in traditional costume

REPRODUCED FROM *THE WORLDS OF THE FEDERATION*
BOOK AND ARTWORK BY SHANE JOHNSON

Cultural Aside:

Although Vulcans are capable of normal sexual intercourse with compatible species, such as humans, the sexual drives of single Vulcans of both genders are repressed via telepathic block at age seven when they are betrothed in the *koonu-tu-kalifee* ("lifemate bonding") ceremony. This repression will result in a violent outburst every seven years known as *pon-farr* (the "blood fever") until they join with their bonded mate in marriage. During this time they *must* engage in intercourse at some point or die from the mental strain. There is *no* alternative to this situation.

KAFERIANS

The Kaferians were the first and still one of the few humanoids whose physiology is almost entirely insectoid. Their heads resemble those of the Terran preying mantis, with large, bulbous eyes and mandible mouths. They have clawed limbs and chitinous exoskeletons. There is also vestigial evidence of two more sets of limbs and wing “stubs” on their backs. There is no question that the Kaferians are the product of genetic engineering – some ancient experiment in ages past and long forgotten in adapting insect life to the humanoid form. Who it was, when it happened, or why the experiment the Kaferian hive-mind does not say.

Despite their unusual appearance, which was a bit frightening to early Terran visitors, the Kaferians are a peaceful species that exist in harmony with their home world’s ecosystem. They live in giant ground-based hives that can reach as high as 300 meters or more, with hundreds of “cells” inside for residence. They follow the insect norm in that they are a matriarchal society, with their Queen being both leader and repository for the Kaferian hive-mind. All Kaferians have a set role in their society to which they are born and from which they rarely change. Such roles include worker, gatherer, soldier, hive-worker, royal attendant, and so on.

Most Kaferians are asexual save for the Queen and her royal drones. The Queen is the lone female and her drones are semi-intelligent breeding stock. The current Queen is the same that ruled when humanity first visited Kaferia in the late 21st century. By her own admission she is centuries old by human measure. When the time comes, she will mate with all of her drones until she is able to produce eggs. From one of these will come the next Queen, who will mutate into the first new Kaferian female in living memory. Once the new Queen is attuned to the fullness of the Kaferian hive-mind, the old Queen will die and the other potential candidates will eventually devolve into the asexual Kaferian norm, joining the rest of her people in the hives.

Kaferians are naturally telepathic by nature of their hive-mind; however, this skill is quite limited. They cannot access the minds of non-Kaferians, although telepaths of other species can access the Kaferian hive-mind through them. They do, however, have a limited ability to read and affect the thought patterns of normal insect life. By the same token Kaferians cannot remain separated from their hive-mind for long. They never leave their world, being content instead to bring the galaxy to their door via interstellar trade and commerce.

VISUAL:

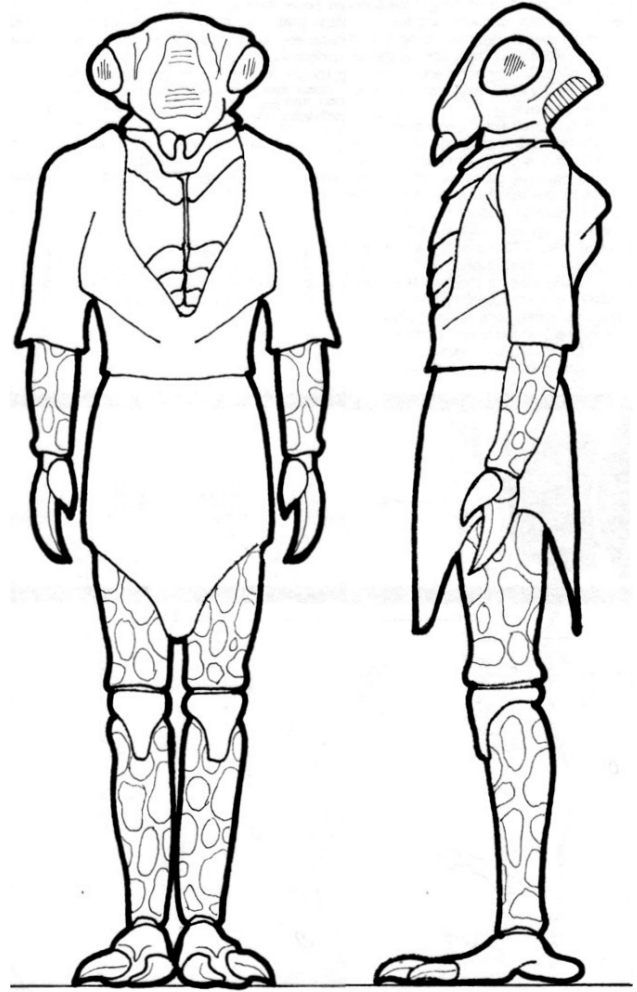

Typical Kaferian in traditional costume

REPRODUCED FROM *THE WORLDS OF THE FEDERATION*
BOOK AND ARTWORK BY SHANE JOHNSON

Asides:

- 1) Kaferians are by nature a friendly, outgoing, and accommodating species that are benevolent to all and show no ill will to none.
- 2) Any Kaferian who is removed from the range of the Kaferian hive-mind will die within 18 standard hours. This unfortunate fact was discovered during a Kzinti raid on Kaferia during the days of the Kzinti Empire, when a group of Kaferians were seized and taken back to Kzin as hostages. No one knows for sure how far the Kaferian hive-mind extends. None are willing to discover its limits for fear of endangering the Kaferians.

TELLARITES

Tellarites are the only known porcine humanoid species in the universe. They are almost certainly the result of genetic engineering in their past. Their history starts abruptly some 15,000 years ago with a fully formed civilization. Their own legends speak of their ancestors being the willing servants of an advanced race who were placed on Tellar Prime for their own safety once their mentors faced extinction from another ancient power. The industrious Tellarites quickly learned to fend for themselves in their new home, forgetting everything about their past lives save for what pieces were preserved in their mythlore.

Tellarites are on the average shorter and more rotund than the average humanoid. Their bodies are covered in thick, short hair. Both males and females have full heads of hair and it is the tradition for adult Tellarite males to wear full beards. While their two-fingered hands with opposable thumbs are not unique, their hoof-like feet are one-of-a-kind among humanoid species. Normal Tellarites have hooved feet consisting of a split dermal pad with dewclaws in the rear. Despite this, or perhaps because of it, Tellarites have an amazing sense of balance and are less prone to motion sickness than other humanoid types.

Tellarites have exceptional senses of hearing and smell. These are offset by their limited visual abilities. They are born with normal humanoid visual capabilities; however, due to their unique genetic structure this rapidly deteriorates with age. By the time a Tellarite reaches advanced middle age he or she is practically blind. Most Tellarites have learned to compensate with their hearing and sense of smell to such a degree that only a skilled observer will note their lack of visual ability.

Tellarite-human crossbreeds are possible and some do exist, although they are rare. Those that survive to adulthood are without exception mentally unbalanced due to incompatible chromosomes. These have softened Tellarite features closer to human norm and "normal" human hands and feet.

Two things make the Tellarites stand out above all other humanoid species besides their appearance. First, they are the best engineers in the known universe. They are responsible for some of the most beautiful and "impossible" starship designs ever built by a humanoid culture. They have a natural aptitude for applied technology and some have theorized that the ability is part of their genetic makeup. It is rare not to find a Tellarite in some engineering capacity on a Federation starship or base. Second, they are legend for their ability to argue. They are loud and combative almost to the point of blows while in the heat of debate, often for no good reason other than the sake of the debate itself. This is often mistaken as true aggression by those who are not accustomed to a boisterous Tellarite in the middle of a good argument. This last is, admittedly, something to which one must become accustomed over time.

VISUAL:

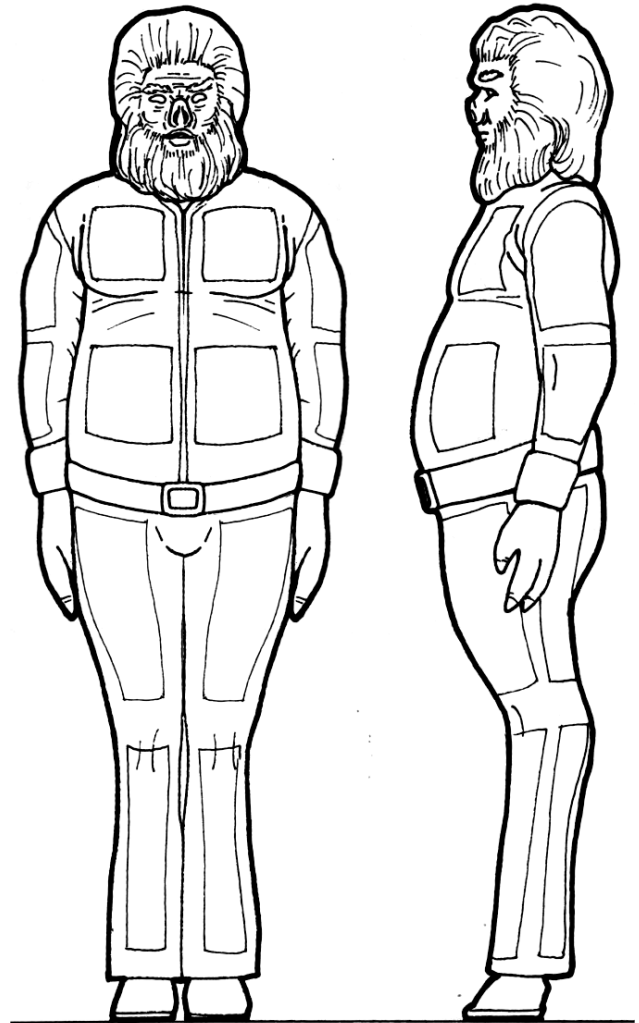

Typical Tellarite male in traditional costume

REPRODUCED FROM *THE WORLDS OF THE FEDERATION*
BOOK AND ARTWORK BY SHANE JOHNSON

Asides:

- 1) Should you sense that you are starting to slip into an argument with a Tellarite, you are best advised to let him or her make his point regardless of whether he or she is right or wrong. If you do not, you can count on the Tellarite insisting on making his or her point, usually rather loudly, no matter what you do or how long it takes until you concede.
- 2) *NEVER* call a Tellarite a "pig" or a "pig-man." You are inviting a physical assault on your person if you do. To Tellarites these terms are the worst of racial insults.

ANDORIANS

Andorians are unique among humanoid species. Certain aspects of their physiology suggest an insectoid origin or infusion at some point in their evolutionary development. Genetic mutation or alteration in their distant past has been suggested as the most likely cause.

Andorians have a limited exoskeleton in addition to a normal humanoid internal skeleton. Their otherwise frail frames thus gain added strength in their limbs and torso, making their comparable in physical ability to most other humanoid species. All of their body hair is white. Their skin is normally toned in shades of blue, usually of a brilliant hue, due to a pigment similar to that found in the chiton of certain insect species. Green-skinned Andorians exist for the same reason but are rather rare; albino Andorians are extremely rare. Perhaps the most noticeable physical trait of Andorian, though, aside from their skin color, is the antennae they have in place of ears. These act as both ears and a second set of eyes.

The ocular aspects of Andorian antennae provide color to their vision. This includes the full range of normal human vision plus a limited ability to see into the infrared. This arrangement of four vision senses also gives them quadriscopic depth perception, since they are in effect seeing with two "sets" of "eyes." The hearing aspects of their antennae are highly developed and allow them to hear a spectrum of sounds wider than a normal human, although their effective range is shorter. Their antennae even have a limited ability for independent movement with special training. Most Andorians, though, simply turn their head in the direction of a sound or conversation and tilt it downward slightly for best reception.

Another unique trait of Andorian physiology is that there are no "left-handed" or "right-handed" Andorians. All of them are ambidexterous, having the ability to use either hand in any endeavor with equal skill.

Andorians are intelligent and highly inquisitive. They are quick studies and can master complex skills quite easily.

The Andorians are a self-admitted warrior race and one of the best in the history of known space, excelling in the martial arts with few equals. For example, they have fought wars with all of their interstellar neighbors (including the Vulcans) in their past. In another example, the Andorians are second only to humans in membership in the Star Fleet Marines. They do not, however, fight without reason. They have a rigid code of honor to which they strictly adhere. Once they join a cause, they commit themselves to it body and soul until either the cause is accomplished or they die. Their patriarchal society has a strong sense of family, with all members of their hive homes caring for their young, weak, infirmed, and aged members.

VISUAL:

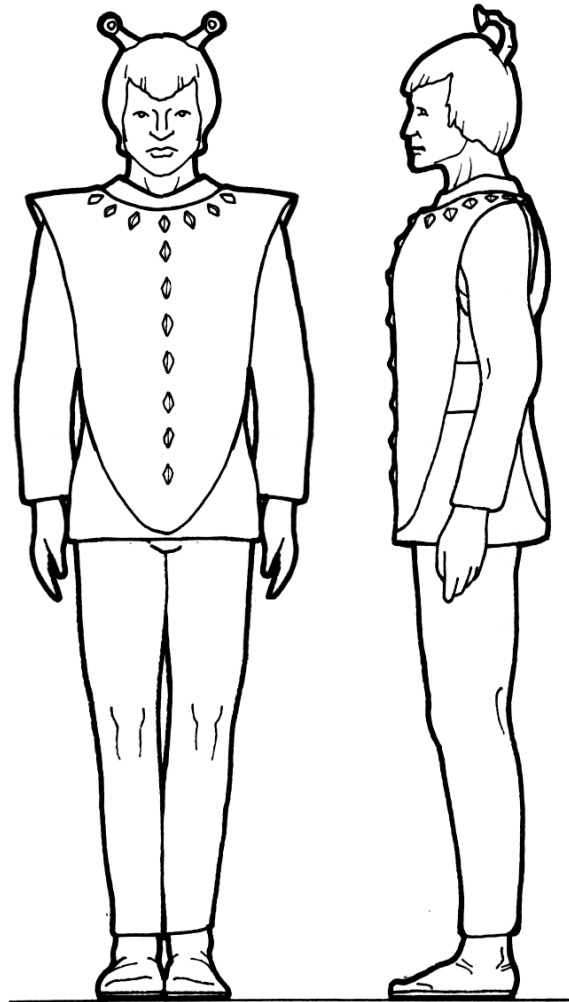

Typical Andorian male in traditional costume

REPRODUCED FROM *THE WORLDS OF THE FEDERATION*
BOOK AND ARTWORK BY SHANE JOHNSON

Asides:

- 1) Most Andorians prefer as warm a temperature as they can stand. This is due to the unique conditions of their homeworld. Their preference seems to be about the same as that of Vulcans.
- 2) Andorians lack the genetic material necessary for telepathy, telekinesis, or any of the extrasensory skills. The neural nets of their brains are completely unsuited for the mental strain of such abilities.
- 3) Andorians normally speak with an accent remarkably similar to that of Terra's Middle European region.

TERRAN EXPLORATIONS

VULCAN

Vulcan (*T'Khasi, Tsaichran*) is a harsh and hostile world. Half of its land mass is volcanoes and lava plains; the other half is storm-swept dust plains and sand dunes. The average surface temperature is 50°C, dropping to as low as 10°C at night and as high as 70°C on the equatorial arid plain known as Vulcan's Forge. Only in its southern hemisphere does the rugged terrain break enough to allow for limited forests and vegetation. Both of Vulcan's freshwater seas, Thanar and Voroth, are located in the planet's southern regions.

The fact that any kind of life arose here at all indicates more than chance was at work, and Vulcan lore speaks of alien intervention in the past. The ancient Arretians are thought to have played a major part, as did the Preservers and other long-dead or forgotten alien cultures. Regardless, the harshness of the Vulcans environment dictated that its major intelligent species would be just as harsh. It took millennia of fighting followed the patient dedication of Surak the Reformer to mold Vulcans from the emotional warriors of their legendary past into the peaceful and logical culture that they are today.

The Vulcans were already an advanced species by the time mankind set foot on the Sea of Stars. Their known history dates back some 300,000 years and their recorded history over 50,000 years. They achieved spaceflight almost 2500 years before mankind and were the first species in the Local Group to achieve faster-than-light travel. Because of this they were more than a match for the Vegans and later the Kzinti when both tried to conquer their homeworld and space colonies. Both learned to cut them a wide berth as they built their respective empires. The Vulcans by reason of their logical culture did not approve of either empire and secretly worked to find and support a culture that would "dominate" the galaxy for more peaceful means. It took them almost another 2000 years before they eventually found that culture in the humans of Terra and Alpha Centauri.

Vulcan's population was small compared to Terra at the time of its first contact with humanity. Its people lived in scattered, yet carefully placed and logically ordered communities. One of the most important of these was and still is the city of Shi'Kahr, which is located within a day's hike of the legendary Sas-a-Shar Plain (Vulcan's Forge). The planet also had extensive orbital facilities and a fleet of ships all kinds. Vulcan traders were, and still are, a common sight within the Local Group systems.

Vulcan has no moon; however, it has a large and lifeless binary planetary companion that in many ways acts as a moon. It is named Charis in Terranglo and *T'Khut* in the Vulcan tongue.



SPECIFICATIONS:

System star: 40 Eridani A (*Nevasa*)

Distance from system star 140 million km
Period of revolution (Terran measure) 26.67 hours
Period of orbit (Terran measure) 389 days
Mass 1.7×10^{28} kg
Diameter 12,952 km
Axial inclination 17°
Average surface temperature 50° C

Satellites none
Planetary companions Charis (*T'Khut*)
Planetary classification M
Level of technology current

Indigenous culture(s) humanoid
(*homo vulcanis*)

Major surface features:

- The L-langon Mountains
- The Mountains of Gol (and Mount Seleya)
- Thanar (Eastern) Sea
- Voroth (Western) Sea
- Sas-a-Shar Plain (Vulcan's Forge)

Places of note:

- The cities of Shi'Kahr and Daicood
- The Fire Plains
- The T'Karath Sanctuary
- The Vulcan Academy of Sciences

KAFERIA

Kaferia (*Kohath-sered*) has often been described as the botanical paradise of the Federation. Almost all of the available land mass is pure vegetation, with few clearings save for those that have naturally occurred due to land formations or normal environmental processes. The natives are insectoid, albeit humanoid in fashion, that reside in ground-based hives built from gathered soil and plant materials. These often reach up over 300 meters tall. Like certain Terran insects and arthropods, the Kaferians can spin a sticky, silk-like substance from their own bodies that is most frequently used as glue and mortar in their daily lives.

The Kaferians are a friendly species that have enjoyed a highly profitable trade relationship with the Federation for years. A major human colony is located on the planet Amber (Tau Ceti IV) and the remains of an earlier one on Shangri-La (Tau Ceti I). There are two human colonies on Kaferia itself but both are strictly limited in their growth and industry so as not to upset the Kaferian ecosystem and way of life. They are very trusting of visitors but are aware from past experience that such trust is often misused. They have never sought Federation membership, preferring instead to remain a trusted ally and trade partner. Their chief export is their fruit and vegetable crops, with Kaferian apples being an especially prized delicacy.

Getting to Kaferia is a difficult proposition. The Tau Ceti system sports two of the largest and most dense asteroid belts in known space. Both of these straddle Kaferia, the system's third planet, and it was not uncommon for it to be struck by an asteroid at least once a year in its past. With the cooperation of the Kaferians the Federation has put in place an orbital defense satellite network designed to intercept and destroy such asteroids. This network also proved of great use in helping to repulse an attempted Kzinti invasion during the Kzinti Incursion of 2272.

Because of its location at the hub of several Local Group spacelanes and its importance as a major agricultural exporter, Kaferia is considered one of the most strategically important planets in the Federation. There is a major Star Fleet supply and starship repair facility in orbit around the system's outermost planet, well clear of the bulk of Tau Ceti's numerous asteroids, as well as an extensive ground support facility. It was the failure to secure the Tau Ceti system, thanks largely to a staunch and hard-fought Star Fleet defense against overwhelming odds, which caused the fortunes of war to turn against the Kzinti during the short-lived Incursion.



SPECIFICATIONS:

System star: Tau Ceti (*Igom*)

Distance from system star	100 million km
Period of revolution (Terran measure)	17.26 hours
Period of orbit (Terran measure)	227.76 days
Mass	5.48×10^{24} kg
Diameter	12,066 km
Axial inclination	16°
Average surface temperature	30° C

Satellites	none
Planetary classification	M
Level of technology	agricultural

Indigenous culture(s)	humanoid (<i>homo kaferis</i>)
-----------------------------	-------------------------------------

Additional culture(s)	none
-----------------------------	------

Major surface features:

- The Lonely Mountain
- The Burning Plain

Places of note:

- The Terra 15 Historical Monument (Tau Ceti I)
- The Amber Colony (Tau Ceti IV)
- The Kaferian Hive-Homes
- Star Fleet Tau Ceti Supply Base (Tau Ceti V)

TELLAR PRIME

Tellar Prime (*Mirachð*) might be considered fairly average for a Class M planet. 53% of its surface is covered with water, it sustains the usual mix of aquatic, surface, and avian life, and it has an average surface temperature of 25° C. The only thing unusual about the planet itself is its negligible axial tilt. It has no seasons as such and weather patterns remain fairly constant in all longitudinal zones. The only other thing unique about the planet is the Tellarite species. They were the second humanoid species contacted by Terra during its early exploratory years in the Local Group and remain among the most unique. Nowhere else in known space does there exist a humanoid species with porcine features such as the Tellar. This suggests alien intervention sometime in Tellar Prime’s ancient past. The fact that their history suddenly “starts” some 15,000 years ago has often been cited as evidence supporting this claim.

Tellarites are by nature loud, boisterous, and argumentative. Their speech patterns are harsh and guttural. They are famous for debating an issue long past the point where reason turns in dogma. This is often assumed as belligerency by those who first encounter them. Such was the case when the Earth exploration ship *Bellephoron* chanced across the Tellarite space ark *Gartov* (named for their Monarch) in 2073. The presumed belligerency of the Tellarite captain caused the crew of the *Bellephoron* to call in reinforcements in the form of a ten-ship UESF squadron under the command of Admiral Abel Niwen. Fearing an invasion by yet another race of evil aliens (their longsuffering under Kzinti occupation all too well known), the Tellarites went into what is best described as “herd panic.” They wrecked their planetary economy by withdrawing all of their savings from their various financial institutions. Shortly thereafter the planet turned into one large riot scene as the Tellarites realized they had practically nothing left with which to stop an invasion by “the evil Terran Empire” even if they wanted to do so. Fortunately the Terrans were able to help restore order and show their true natures by sending only one ship to Tellar, the explorer *Leif Ericsson*, and arranging a meeting with Monarch *Gartov*. The public broadcast of this meeting and the frank honesty of *Ericsson* skipper Harland Anders soon helped to assuage Tellarite fears.

Tellarites are natural engineers. They have a long history both before and during the Federation for their starship engine technology. Kloatis Drive Systems is second only to Cochrane Warp Dynamics as the Federation’s leading maker of sublight and warp engines for starships and spacecraft of all sizes.

The only other idiosyncrasy of note regarding the Tellarites is their preference for mud baths. This has made their world a haven for sorts among certain groups of humanoids for various reasons. The Tellarites have taken advantage of this and set up a series of popular mud bath spas for visiting tourists.

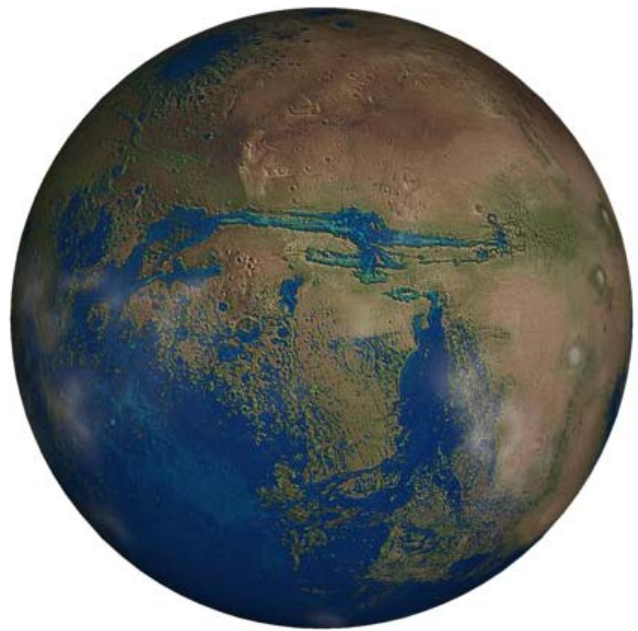

SPECIFICATIONS:

System star: 61 Cygni A (*Hahrnohð*)

Distance from system star 98 million km
Period of revolution (Terran measure) 27.34 hours
Period of orbit (Terran measure) 238.93 days
Mass 9.2×10^{24} kg
Diameter 3446 km
Axial inclination 1.7°
Average surface temperature 25° C

Satellites 3

(*Keers, Phinda and Sulehp*)

Planetary classification M

Level of technology current

Indigenous culture(s) humanoid

(*homo cygnl*)

Additional culture(s) none

Major surface features:

The continents of Thrun and Borkak

The Ancestral Plains

The Heights of Thule

“Razorback” Ridge (The Knife Hills)

Places of note:

The Tellarite Academy of Engineering Sciences

Kloratis Drive Systems

The Great Hall of the Gomangani (Monarch of Tellar)

The Space Ark *Gartov* (orbital museum ship)

ANDOR

Andor (*Fesoan*) is the eighth of nine planets orbiting an orange dwarf star. It is a largely dry, cold, and barren Class K world. In the past it was sometimes mistaken as the moon of its neighboring planet by early explorers. This is a gas giant whose close proximity and identically locked orbit make it a permanent feature in the Andorian sky. The odds against such a planetary alignment of orbits are so miniscule as to suggest outside intervention by the Preservers. No evidence of this, though, either on the planets in question or within what remains of recorded Andorian history and mythlore, has yet to be found.

There is little surface water on Andor and most of this remains frozen year round. Present beneath the surface, however, are large caverns heated by geothermal energy. These also feed a number of surface geysers to replenish the limited, perpetually frozen surface water supply. Most of the life on Andor, both plant and animal, is congregated inside these heated sub-surface caverns. The Andorians likewise live in this subterranean cave network, with large underground cities and a sophisticated travel tube network connecting them. Illumination normally provided by a phosphorescent-like fungus that produces a steady "cold light" similar to that of the Terran firefly. Extra artificial lighting is usually present wherever the Andorian people have established themselves.

Andorians rarely venture onto the surface of their world due to its extreme cold. Their few excursions are limited to the planet's brief summer, when the daylight temperature rises to a barely tolerable -15° C. In past times these ventures were tests of skill and daring for Andorian warriors, who would brave spending a summer night on the surface of Andor to prove their might. This practice was eventually abolished for the reckless endeavor that it always was.

All of Andor's major surface spaceport facilities can only be accessed by underground hangars. These are too small to permit passage of anything larger than a trader ship or small Class II transport. Instead, most visiting starships dock at or enter parking orbit near the Andor Spaceport orbital space station. They then travel to the planet via transporter or shuttle.

Modern Andor is a major manufacturing center for Star Fleet weaponry and support systems. The Chiokis Starship Design group, a joint Terran-Andorian business headquartered on Andor, is responsible for pioneering the basic primary hull saucer design that has since become a trademark of Star Fleet vessels. Chiokis-designed primary hulls have been used in almost every major Star Fleet starship class starting with the *Baton Rouge* and *Ranger* classes of the early 2200s and continuing on through the Class I starships (2230s-2240s) to the linear warp and transwarp vessels of today.

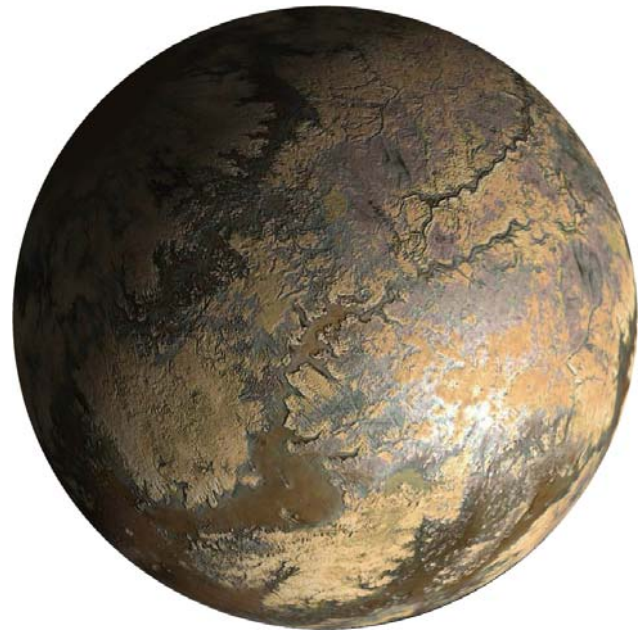

SPECIFICATIONS:

System star: Epsilon Indii (*Kay'va*)

Distance from system star 294 million km
Period of revolution (Terran measure) 21 hours
Period of orbit (Terran measure) 170 days
Mass 2.9 x10²⁶ kg
Diameter 18,125 km
Axial inclination 18°
Average surface temperature 10° C

Satellites 3
Planetary classification K
Level of technology current

Indigenous culture(s) humanoid
(*homo indii*)

Additional culture(s) none

Major surface features:
The continent of Zhevra
The Khyzhon Sea

Sites of interest:
The Andorian Academy of Art
The Wall of Heroes
The Plaza of Freedom
The Chiokis Design Orbital Starship Museum

VEGA IX

Vega IX (*Kesir-Tosharra* in the Deltan tongue) was once the homeworld of the Vegan Tyranny. It was an interstellar empire ruled by a cybernetic species akin to the Borg that at one time dominated most of the Local Group and beyond. Their empire went into decline about the same time as the rise of the Kzinti. This was due to the outbreak of *vegan chloriomeningitis*, an extremely virulent disease known in surviving Vegan records as "the Green Death." This swept the Vegan Tyranny in epidemic form sometime around the 21st century (Terran Old Calendar). This has led some to speculate that the Kzinti took advantage of the Vegan's downfall and took over most of Vegan territory as their own with little opposition. When humanity first visited Vega IX in 2094 they found a Deltan colony already there amid the ruins. This was humanity's first encounter with the Deltans. After an initial rough start, growing relations between the two cultures eventually led to formal relations. Both settlements, human and Deltan, continue to grow and thrive as of this date.

The only native lifeform of note on Vega IX in these times is the Scora. Nicknamed "the Bigfoot of Vega" by early human colonists, the Scora average 14 feet in height and can be quite belligerent when provoked. They are by nature, though, a shy species and prefer to keep to their caves on the Vegan lowlands. The resident human and Deltan colonies, on the whole, avoid them whenever possible so as not to cause any confrontation. The Scora lack intelligence although they have demonstrated the capacity to learn in captivity. This has led some to suggest the radical theory that the Scora are the true form of the original Vegans. No proof has ever been found to support his claim.

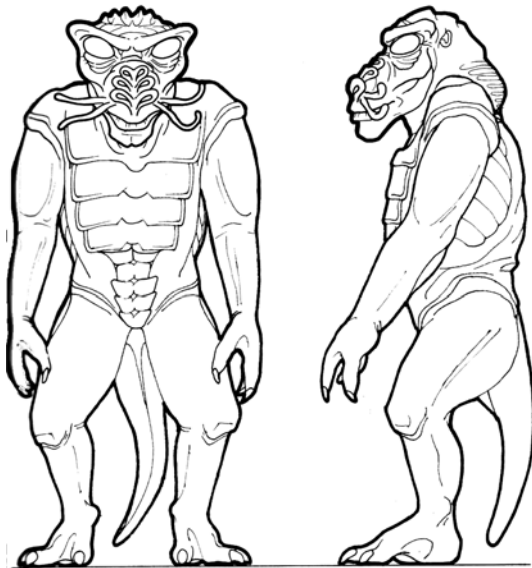

Front and side views of the Scora

REPRODUCED FROM *THE WORLDS OF THE FEDERATION*
BOOK AND ARTWORK BY SHANE JOHNSON



SPECIFICATIONS:

System star: Tau Ceti (*I/sik*)

Distance from system star 120 million km
 Period of revolution (Terran measure) 22.92 hours
 Period of orbit (Terran measure) 512.26 days
 Mass 3.1 x10²⁴ kg
 Diameter 6840 km
 Axial inclination 36°
 Average surface temperature 15° C

Satellites none
 Planetary Richter Scale rating M
 Level of technology current

Indigenous culture(s) extinct
 (*cybus veganis*)
 Additional culture(s) humanoid
 (*homo deltus*)
 (*homo terran*)

Major surface features:
 (none – atmospheric distortion)

Places of note:
 Hadley's Hope (human colony)
 New Dorado (Deltan colony)
 The Vegan Tyranny Archaeological Complex

HISTORICAL ARTICLES

STUDY PROVES REAL ALIENS DON'T EXIST

UNS NEWSWIRE – 8 JUNE 2057



Today the Xenobiological Studies Committee of UESPA released its report on the probability of life outside the Solar System. In a press conference, chairman Dr. Maurice Bertrand, former head of the International Space Agency, expressed his committee's conclusion that the probability of non-human life in space is so low as to be practically nonexistent. This statement brought an immediate barrage of questions from reporters concerning the Kzinti, who are obviously not human. Dr. Bertrand was quick to respond.

If you will but read the report, ladies and gentlemen, you will see that we say "human life form" versus "non-human life form." The Kzinti are obviously a human life form – overgrown cats that have evolved along human lines. They walk on two feet, have vocal cords, and even collarbones as do humans. Their tails are the same that we would have if our tailbones had not receded during our development. Let us change viewpoints. If we humans still had body hair we might still be regarded as apes. That is why I must reiterate our conclusions that intelligent life must evolve from mammalian life and along recognizably human lines. This obviously limits what forms of intelligence you might see. You will never see intelligent insects, for example. It is impossible for an insect to evolve along human lines.

Reaction to Dr. Bertrand's statement was quick. "He's nuts," said one spectator. "What a bunch of morons," said another. UESF Corporal Benjamin Dixon, recovering from battle wounds and who attended the conference out of curiosity was more blunt. "That's a bunch of bulls**t. Stuffed shirts, all of them. They haven't been out there. All they do is sit behind their desks and play with their papers and pencils. I've been out there, and I've got the scars to prove it. I've seen some pretty strange things, and I'm telling you. One of these days we're gonna find a planet with some of the weirdest lookin' critters you've ever seen, and they're gonna be as smart as us. And when they do, this bin of loonies are gonna be lookin' for new jobs.

AMITY FINDS NEW ALIENS

UNS NEWSWIRE – 16 JANUARY 2065

UESPA has announced that one of its ships, the explorer vessel *Amity*, is assisting a disabled alien ship in space. These aliens are not Kzinti but a humanoid type never encountered before. Captain Peter O'Brien, commander of the *Amity*, reports that they were peaceful, nonviolent, and in desperate need of assistance. UESPA permitted Captain O'Brien a brief interview with UNS reporter Tamilyn Wesley, and this is what he had to say about the encounter:

O'BRIEN: It was a design I had never seen before – all rings and hull, like the old starliners. Red, like a Kzinti ship, but a lot darker. They were broadcasting in almost perfect English – a little too perfect, with a trace of a weird accent. Kind of like somebody back on Earth might learn at a language school. Anyhow no Kzinti I've ever saw or heard could talk in English like that.

WESLEY: And that's when you made the decision to go ahead and board the ship?

O'BRIEN: I exercised my command discretion Article EOP-113. Deep Space Rescue, of the UESF Code of Conduct. I answered their distress call, just like I would any other space mayday.

WESLEY: And what did you find?

O'BRIEN: I found 42 Vulcans – that's what they call themselves – huddled together in the central compartments of the ship. Their engines and life support systems had gone down at the same time and there weren't enough suits on board for everyone. The captain had already taken their shuttle to try to get help. They were lucky we found them first.

WESLEY: Why is that?

O'BRIEN: Because they would have been dead inside an hour if we hadn't found them. That's what they said in their distress call and their story checked out after we gave their ship a once-over.

WESLEY: At any time during the rescue did you think this might be a Kzinti ploy or trap?

O'BRIEN: I had my doubts at first. Just like any of us would have after the war. After I heard their distress message and saw their ship, though, I changed my

mind. Kzinti aren't known for subtlety and this was completely out of their style. Once we got on board and met the Vulcans, I knew I was right.

WESLEY: And your impression?

O'BRIEN: They're a very logical people. A bit cold and aloof at times, and they can do numbers and make calculations as fast as any computer I've ever seen. They don't understand slang very well. Still, though, very friendly in spite of this. Remember, they reached out to us. They didn't have to. I think that's significant.

Ms. Wesley got the opportunity to speak with Stahl, the Vulcan First Officer, before the interview ended.

WESLEY: So your captain has returned now?

STAHL: Yes.

WESLEY: Was he surprised that you had been found by an Earth ship?

STAHL: No.

WESLEY: Why is that?

STAHL: We knew that human ships were in the sector. We have been aware of your presence in space for some time.

WESLEY: Why were you so sure the *Amity* would help you?

STAHL: We have visited your world in the past many times, although you have not been aware of us. We know that despite your emotionalism you are a caring and compassionate people. We knew you would help if we asked, so we asked.

WESLEY: You've been to Earth before?

STAHL: Yes. Why does that surprise you?

WESLEY: It's just that—well, I mean—you never told us you were there?

STAHL: For what reason would we reveal our existence?

WESLEY: You could have landed on the White House lawn or something.

STAHL: Why would we want to land on the frontal turf of a bleach-toned residence?

WESLEY: Why would we—oh, never mind.

REAL ALIENS FOUND

UNS NEWSWIRE – 7 MARCH 2066



They're intelligent, peaceful, friendly, and very *alien*. They're the Kaferians of Tau Ceti, the third major alien species discovered by UESPA within the past 50 years. UESPA public affairs director David van Dreesen had this to say about his agency's latest discovery:

They go totally against what our past study had predicted, yet here they are. I must be honest and say that we are completely baffled to find intelligent insects anywhere in the universe, let alone humanoid ones. This is going to require us to abandon our previous theory concerning alien life and come up with a new one.

The author of that theory, Dr. Maurice Bertrand of the *New Paris L-4* space city, was unavailable for comment.

LAST SPACE ARK LEAVES TERRA

EXTRACT FROM THE *SPACE FLIGHT CHRONOLOGY*

BY STAN & FRED GOLDSTEN (NEW YORK: POCKET BOOKS, 2269)

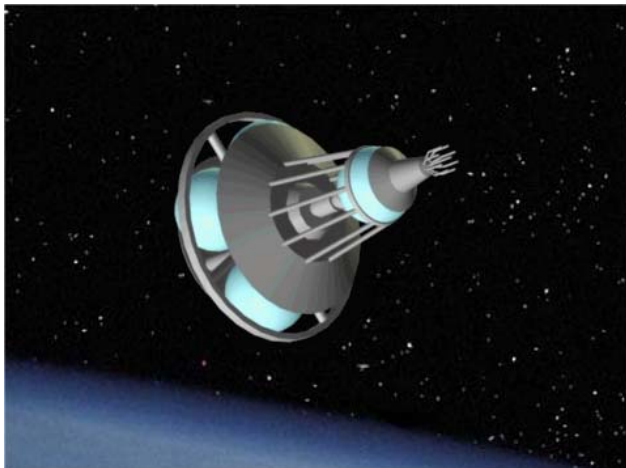

At the time this was written the authors had apparently overlooked the launch of Terra 15, the real last "space ark."

There were some people, though, for whom all governments were equally to be shunned. During this period, several multi-generational colony ships were launched to seek out new worlds to settle, undisturbed by any outside interference. Using by-then outmoded fusion propulsion, these pilgrims knew they were destined almost assuredly never to return ... and none did. The lifeless wreckage of eight of these valiant, doomed ships has been salvaged. One (Terra 10) survived, marooned on a barely habitable, volcanic world. One has never been found.

The world that Terra 10 finally reached was a previously undocumented planet orbiting the star Cepheus in the Arachna sector. Upon making planetfall, the colonists discovered (much to their chagrin) that their new sun's constant spiroid epsilon ray bombardment caused their molecular structure to compact, shrinking all of them to an average height of one centimeter in just over half-an-hour. Despite this, or perhaps because of it, they survived and flourished, cannibalizing their space ark over generations for raw materials. They remained missing until they were found by the starship Enterprise in 2264.

VALIANT MISSING, FEARED LOST

UNS NEWSWIRE – 19 MARCH 2071

Today UESPA announced that the galactic survey cruiser *Valiant*, on a special mission to the galactic rim, is officially declared as missing and presumed destroyed. There has been no communication with the *Valiant* since the ship was lost in an ion storm almost two years ago. No more efforts will be made to probe its flight path and attempt to discover what happened to it and its crew.



The *Valiant* was one of the first UESPA survey cruisers to leave the Solar System on a peaceful mission of exploration following the end of the Earth-Kzin Wars. It left in 2065 under the command of Captain Carlos Tarasco with orders to follow the flight path of the doomed spaceship *Courageous*, which was lost with all hands due to an engine accident in 2022. It rocketed out of the Solar System at full speed headed upward towards the northern galactic rim until all contact was lost. Tarasco's orders was to follow the flight path of the *Courageous* for as long as he could, replenishing his supplies along the way if possible and surveying nearby star systems for wreckage or other signs in the event the *Courageous* somehow made planetfall, until he reached the point of no return and had to turn back. Instead of finding the *Courageous*, though, the *Valiant* found a severe ion storm a year out from Pluto and all contact was lost. It is believed that the ion storm which appears to have claimed the *Valiant* probably claimed the *Courageous* as well. A memorial service is being planned.

STANDOFF IN SPACE RESOLVED

INTERSTELLAR NEWSLINE WITH LISA CAULFIELD

24 AUGUST 2073



CAULFIELD: The newest alien threat to humanity turns out not to be a threat after all. The porcine Tellarites, who first threatened the Star Fleet cruiser *Bellerophon* with an attack and then ran for home at the first sight of a Star Fleet squadron, have turned out to be more bluster than brawn. Lots of bluster, in fact. These beings seem to live to argue, and they argue about anything. The near state of war between Terra and Tellar this past week appears to have been the result of a simple misunderstanding. Star Fleet Captain Harland Anders of the starship *Ericsson* recently concluded talks with Gartov, the Tellarite monarch in order to clear up the misunderstanding. Captain Anders?

ANDERS: Yes, Lisa.

CAULFIELD: Captain, how did you and Monarch Gartov resolve this situation?

ANDERS: Well, Lisa, the last thing we needed was another war. We had seen only one Tellarite ship and no other since. Star Fleet Command had a hunch that the Tellarites were bluffing and decided to call them on it.

CAULFIELD: But why just one ship? Why not a show of force?

ANDERS: It was a calculated risk. We had already shown them force. They had turned tail and ran all the way back to their homeworld. We wanted to give them the chance for peace instead of more force.

CAULFIELD: What did you find once your ship arrived at the Tellarite homeworld?

ANDERS: Total chaos. Sporadic riots, buildings on fire, mobs in the street. You see, and I didn't learn this until my talks with Monarch Gartov, but they had been invaded by the Kzinti a long time ago. The ratcats had killed almost everyone and stripped the planet of everything. They had to start all over again, just like the Middle East did after the Post Atomic Horror. When our fleet showed up and called their space ark captain's bluff they thought we were going to be the next Kzinti and panicked. I guess I can't blame them.

CAULFIELD: Well, I'm glad we got that all worked out. They seem to be a very ... *interesting* species.

ANDERS: Don't let appearances deceive you, Lisa. They are smart as whips and they learn fast. Some of their engineers are already trying to copy our ships based solely on the visuals they've recorded. You should see that space ark of theirs. It's like nothing I've ever seen, not even in the Star Fleet Archives. Come to think of it, the Tellarites are the ones who really invented the jump drive the Kzinti were using.

CAULFIELD: They are?

ANDERS: Yes. It's all recorded in their historical archives. It was stolen from them by the Kzinti and the inventors hauled off or killed right after they invaded.

CAULFIELD: Interesting. Not to change the subject, Captain Anders, but I would like to hear more about this *arguing* of theirs.

ANDERS: Yes. (laughs) They almost consider it a sport. Kind of like the old *Monty Python* "Argument" routine at times, when you end up yelling at each other for something small and petty. It takes some getting used to, I'll admit.

CAULFIELD: Did you argue with Monarch Gartov?

ANDERS: But of course. If I hadn't it would have been an insult and we would have gotten nowhere.

CAULFIELD: What did you argue about?

ANDERS: Oh, the usual. Religion, politics. Things like that. Who was really at fault, who was going to cave first, who was going to apologize first, who was make the announcement about our new alliance. They really do argue about *everything*.

SPACE LANE NETWORK ESTABLISHED

UNS NEWSWIRE – 16 APRIL 2071

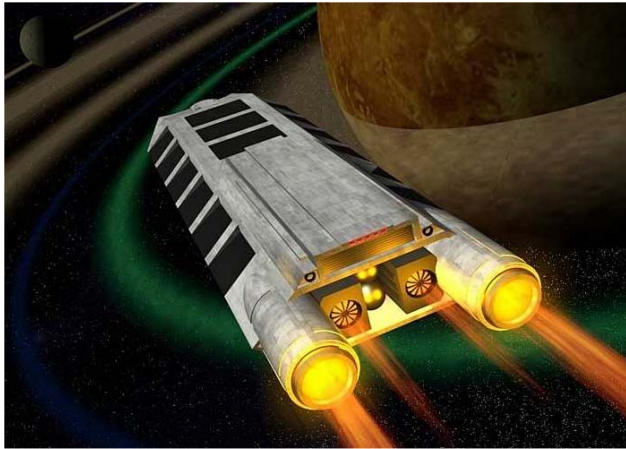

Get used to seeing more alien starships in the Solar System in the future. The first commercial space lanes were officially declared open for commerce today by government representatives of the Sol System, Alpha Centauri, and Vulcanian star systems. These are expected to increase trade and help build stronger cultural ties as starships of all kinds begin to ply these routes.

The first ship to ride the new space lanes to Earth is the Centaurean spaceliner *Helios*, specially chartered for the occasion. Aboard is a delegation of Centaurean merchants here to visit Earth and Mars, looking to set up offworld venues for their businesses. The next ship on the space lane schedule, the Vulcanian trading vessel *S'htok*, is scheduled to arrive at the Martian Colonies tomorrow morning.

SUBSPACE RADIO A REALITY

INTERSTELLAR NEWSLINE WITH LISA CAULFIELD

17 APRIL 2074

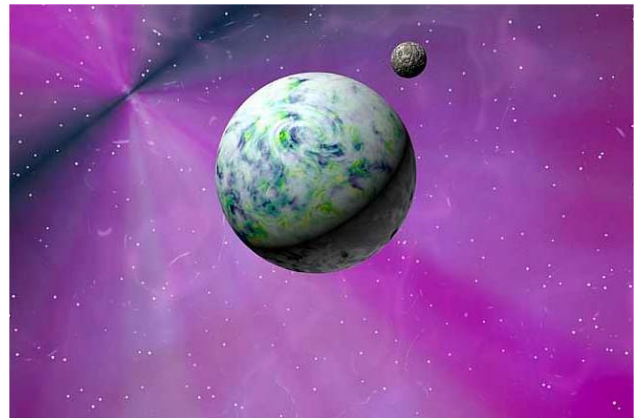

Good evening. This is Interstellar News and I am your host, Lisa Caulfield of Earth. To all of our new listeners across the worlds and space colonies of Earth, Alpha Centauri, Vulcan, and Tellar, I say, "Welcome."

Our top story tonight is the technology that is making this very broadcast possible. Today, in an official ceremony at Tokyo, Japan, the first subspace radio network was activated. Our broadcast tonight is coming to you live over that very same network. With us in the studio tonight is Centaurean representative Zormer Ganderane, who was among the offworld delegates present to dedicate the new system. Mr. Ganderane, thank you for coming.

GANDERANE: Glad to be here, Ms. Caulfield.

CAULFIELD: Just how important is subspace radio?

GANDERANE: It's the biggest communications breakthrough for any of our worlds in our joint history. We don't have to worry about lags in regular transmission that last for years, or even decades. We no longer have waste time hunting for just the right geon hole that goes from point Alpha to point Beta. We can now communicate, both vocally and visually, any time we want without delay.

CAULFIELD: What will this mean for space exploration?

GANDERANE: It means that our new ships will be able to go farther out without having to worry too much about getting out of touch with our worlds. Mind you, they'll be dropping subspace relays as they go, too. All of the Local Group is on line now. We hope to have all of the New Territories on line by the end of the century.

THE WONDERS OF RIGEL

SHIP'S LOG – MARCO POLO – 27 JULY 2079



The following was recorded by Captain Lorenzo Malfatti of the starship Marco Polo on his first night after making planetfall in the Orion Colonies.

Ship's log, Earth time 27 July 2079, 0245 hours. I have just come from the most exotic and bizarre market I have ever seen in all my life. It's called Rralrark, whatever that means. Aliens of every size, shape, and description – including many I've never seen before – are everywhere buying and selling. We attracted attention at once. Seems they'd never seen humans before. We could say the same about them. Barga quickly steered us toward the Rigellian officials, who look like Vulcans but sure don't act like them. More like us. Anyway, some of them could speak a little Tellar, so Barga was able to make arrangements for us. We got room and board and an invite to no less than 57 different booths within the hour. I called the ship to make sure Jake and Jess were okay, then we set off for a little sightseeing.

I saw things today I thought I'd never see. A little creature like a hairy porcupine arguing with a Rigellian over the price of a diamond – a diamond as big as my *fst*. His whole table was full of them along with jewels of every other size and color. An Andorian swordsmith demonstrating how sharp his blades were to an eager crowd. A Vulcan merchant, quietly sitting at his stall while aliens yelled and ran all around him. Clothes that shrink or grow to fit your size and never need washing. Oh, that shop was a lu-lu. The owner offered me his whole inventory for my belt buckle, so I let him have it. Guess he'd never seen a titanium alloy before. I guess he was a he. Come to think of it, I don't exactly know if he was a he or not.

Speaking of which, there's the green women. "A specialty of Orion," their owner told us. "Green animal women slaves trained to fulfill your every desire and pleasure." I had to pass – Kathryn would have killed me before I even put my first foot down on the landing ramp – but, man, are they tempting. They have this ... well, I can't really describe it. They *make* you want them. It's powerful. Too bad slavery's illegal back home, otherwise they couldn't sell enough of 'em.

FIRST EARTH-ALIEN CREWS

UNS NEWSWIRE – 9 NOVEMBER 2083

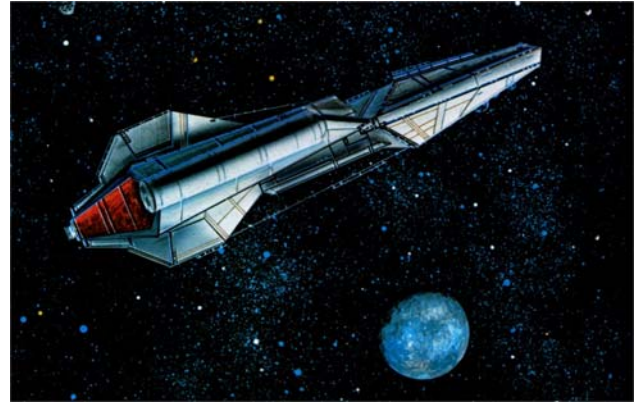

It wasn't that long ago when "little green men" were the subjects of fear, speculation, and science fiction. Space aliens became a fact not that long ago with the Earth-Kzin Wars and the harsh Kzinti. The end of the war saw more peaceful aliens in the Vulcans and Kaferians. Today history is being made, with the first-ever alien to serve aboard a human starship taking his post.

Supak is a communications specialist on his homeworld of Vulcan. He hails from the ancient city of Shi'Kahr. Forty-two years old, he is still considered young on a planet where the average lifespan is 150 years or more. Supak volunteered to be the first Vulcan to serve aboard a human ship in a special exchange between Star Fleet and the Vulcan Space Command.

I am looking forward to serving with humans despite your predilection towards emotionalism. It will give me the opportunity to observe humans in their natural work environment and become accustomed to their idioms and mores. I know that Captain Tse Sum is also looking forward to learning more about my culture from me.

Captain Shu Tse Sum is a fifteen-year Chinese veteran of Star Fleet and one of its leading commanders during the Earth-Kzin War.

I know that things will be difficult for Supak at first. We are a more emotional people than he and to that he is not accustomed. Still, I for one will be glad to have him aboard. The Vulcan way is very much like my own Buddhist upbringing. In our common desire for peace and tranquility we have common ground. I hope that together we can work to make his assignment an enjoyable one. Pardon, that isn't the right word – an *interesting* one.

Supak is starting a temporary six-month assignment to the *Pallux* as communications officer.

SCHEMATICS

VOLUME 03 (NOT TO SCALE)

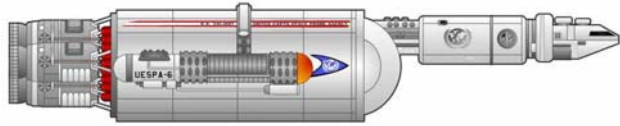

KELDYSH CLASS SURVEY CRUISER **(2064)**

Length: 97 m Drive: first generation warp drive
Mass: 6800 DWT Range: interstellar
Armament: lasers, missiles Crew: 80

UESF SHUTTLE **(2064)**

Length: 22 m
Mass: 27.5 DWT
Armament: lasers
Drive: impulse
Range: interplanetary
Crew: 6

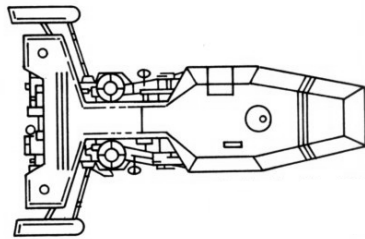

FRIENDSHIP ONE SPACE PROBE **(2067)**

Length: x cm Drive: impulse
Mass: x kg Range: interplanetary
Armament: none Crew: x

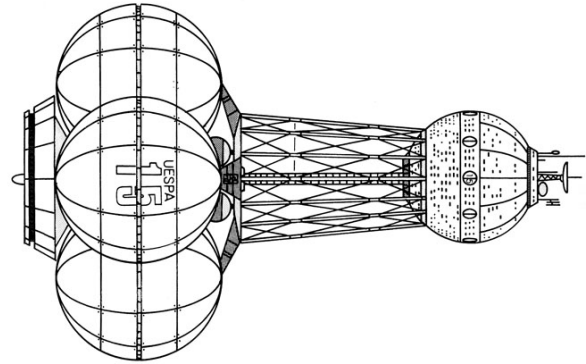

INDUSTRIAL SPACE ARK **(2067)**

Length: 306 m Drive: impulse
Mass: 38,000 DWT Range: interstellar
Armament: none Crew: variable

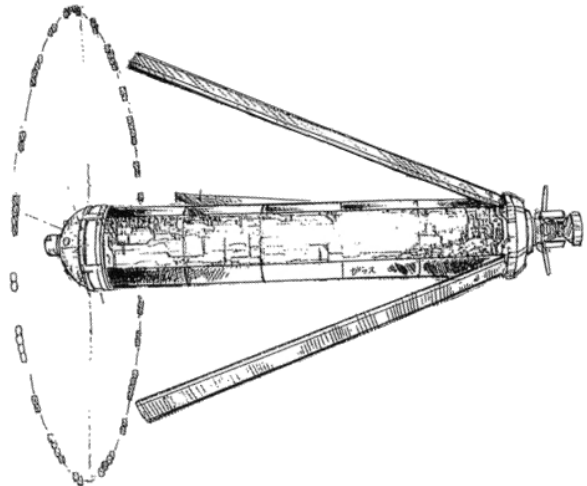

WANDERER (CONVERTED L-5 SPACE CITY) **(2071)**

Length: x m Drive: impulse
Mass: x DWT Range: interstellar
Armament: none Crew: x



MERCHANT CLASS EXPLORER
(2072)

Length: 163 m Drive: first-generation warp drive
Mass: 14,950 DWT Range: interstellar
Armament: lasers, missiles Crew: 4



TELLARITE SPACE ARK GARTOV
(2073)

**COCHRANE
INTERSTELLAR
EXPRESS**
(2074)

Length: 53.5 m
Mass: ? DWT
Armament: none
Drive: first-generation warp drive
Range: interstellar
Crew: 20

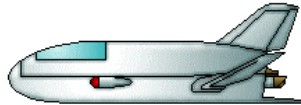

**FRANKLIN
CLASS SCOUT**
(2075)

Length: x m
Mass: x DWT
Armament: x
Drive: x
Range: x
Crew: x

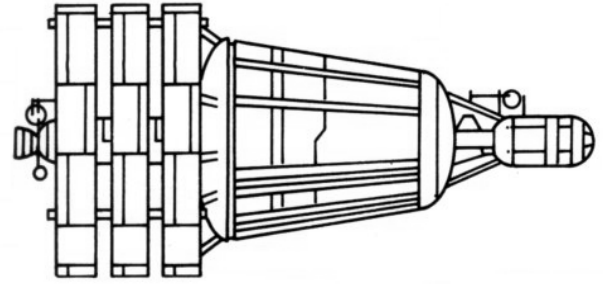
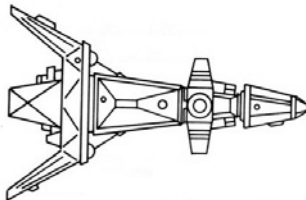

AQUARIUS CLASS AUTOMATED TRANSPORT
(2076)

Length: 150 m Drive: impulse
Mass: 19,000 DWT Range: interplanetary
Armament: none Crew: none

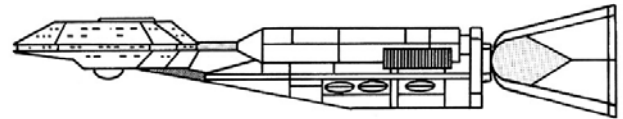

BONAVENTURE (FIRST REFIT)
(2080)

Length: 206 m Drive: warp drive
Mass: 19,400 DWT Range: interstellar
Armament: lasers, missiles Crew: 45

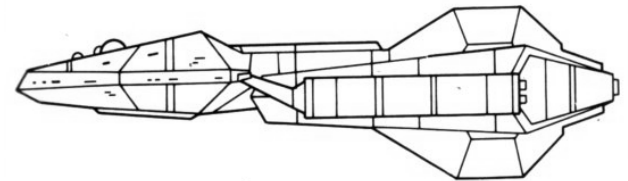

MESSIER CLASS CRUISER
(2078)

Length: 258 m Drive: warp drive
Mass: 27,700 DWT Range: interstellar
Armament: lasers, missiles Crew: 93

**WP-174
WORK POD
(2079)**

Length: 34 m
Mass: 48 DWT
Armament: none
Drive: impulse
Range: interplanetary
Crew: 4-6

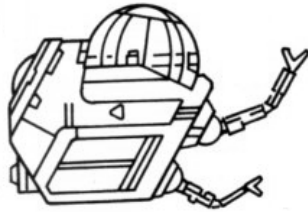

**QUANTUM SERIES
DEEP SPACE PROBE
(2080)**

Length: 100 m
Mass: 8,000 DWT
Armament: none
Drive: warp drive
Range: interstellar
Crew: none

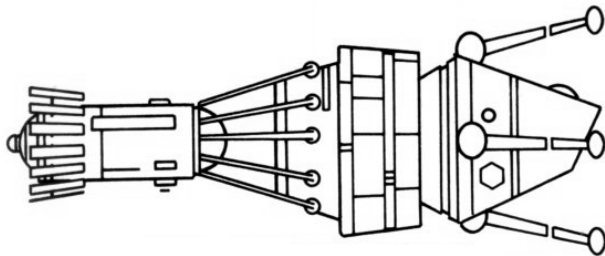
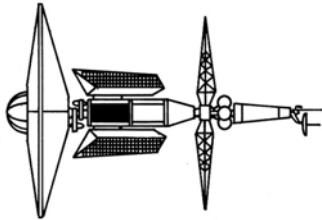

**ASSIST CLASS SPACE TOW VEHICLE
(2085)**

Length: 98 m
Mass: 13,500 DWT
Armament: none
Drive: warp drive
Range: interstellar
Crew: 20

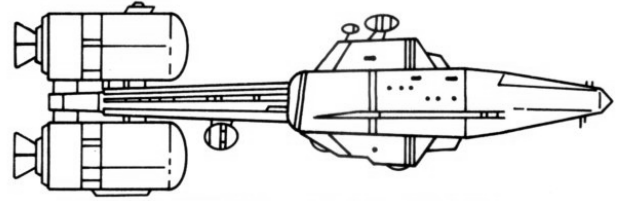

**EDISON (DY-1000 SERIES)
(2084)**

Length: 246 m
Mass: 34,000 DWT
Armament: none
Drive: warp drive
Range: interstellar (planned)
Crew: 58

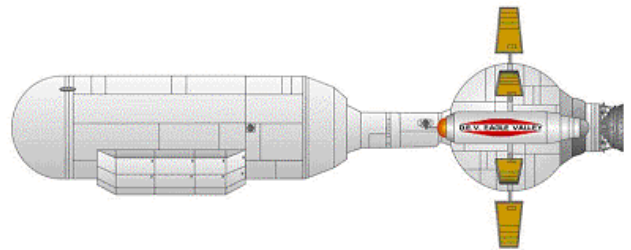

**ASGARD CLASS TRANSPORT (DY-900 SERIES)
(2100)**

Length: x m
Mass: x DWT
Armament: x Crew: x
Drive: warp drive
Range: interstellar



to be continued ...

ACKNOWLEDGEMENTS

VOLUME 5: 2065-2100

AUTHOR'S COMMENTS:

I'd like to start off by thanking Aridas Sofia for giving me permission to use one of his designs for this work. This would be the Tellarite space ark *Gartov*. He was also kind enough to give me permission to alter its backstory to better fit with this work. While I'm at it, I'd also like to thank TallGuy for the *Gartov* 3D model that he made for Aridas and which is reproduced here. You can find more pictures of it over at the Federation Reference Series Online website.

The Cold Peace is one of the many contributions by novelist James Blish (the *Star Trek* series of script adaptations by Bantam Books) from his many stories about his own sci-fi universe. *Cities in Flight* is probably the best place to start, although it's rather hard to find these days.

I put the note in about the gradual demise of geon hole communications to explain its glaring absence on screen in the *STAR TREK* era. By that time I see it being the "ham radio" of space buffs. Kinda like Morse Code still being taught to Terran communications experts even though it's been obsolete for centuries.

The bankruptcy of Dyson-Yoyodyne is my own contribution. It is meant to explain why the company no longer appears to be prominent in the TOS/TAS era.

The logo for Cochrane Warp Dynamics comes courtesy of Memory Beta. They had it listed as a seal for the Alpha Centauri Concordium of Planets, which contradicts that given in the *Star Fleet Technical Manual*. I "hijacked" the design for Cochrane's company instead.

I changed some of the details about mankind's first visit to Kaferia (Tau Ceti) in order to make them better fit within the Prime One timeline. The original SFC states unequivocally that it was the *Bonaventure* that paid humanity's first visit to Kaferia. This visit is contradicted by Lawrence Miller's *Starfleet Tactical Database 2* blueprint set, which states that a Terran space ark was the first. I removed all references as to which ship was the first to visit Kaferia for the sake of internal consistency in this work. I did, however, slip in a picture of the *Bonaventure* at Kaferia as an allusion to the original account.

I also deliberately veered away from the SFC's description of the first encounter with the Tellarites in this work. I had already established that the Tellarites had to rebuild their civilization from "long ago" after a Kzinti invasion and occupation per Volume 04. This makes unbelievable the SFC scenario, in which

a lone Tellarite ship suddenly turns up on the edge of the Sol System. I borrowed some ideas and the *Gartov* from Aridas Sofia (with his permission) and put first contact much closer to Tellar Prime, with the space ark *Gartov* running afoul of Terra's post-Kzinti war space fleet. This puts the new version of events more in tune with that given in Shane Johnson's *Worlds of the Federation*. It seemed to make more sense given how the Prime One chronology was developing at this point.

Likewise I altered the account of humanity's first encounter with the Orion colonies. It made more sense to me that a trading vessel would make first contact as opposed to an "official" survey ship. Such is always the case with new frontiers, where lone traders go into the area long before official government expeditions.

I don't want to hear anyone say anything about, "You got the entry on Andor wrong!" or something like that. I didn't. Remember, that business about it being a moon is in the Prime Two (Okuda) timeline. This is Prime One (modified Graham/Mandel). Back before *First Contact* and *Enterprise* came along and screwed everything up it was pretty much a given that the home star of the Andorians was Epsilon Indii. That comes from the original *Star Fleet Technical Manual*, thank you very much, which WAS canon at the time it was published. *Enterprise* is non-canon in the Prime One timeline; therefore, the good ol' *SFTM* still holds sway here. I have also tried to avoid everything that was developed about the Andorians in *Enterprise*, although I may have missed a thing or two. Besides ... it looks like whoever developed the Andorians for *Enterprise* spent many a drunken night reading Shane Johnson's *The Worlds of the Federation*. I was even surprised to see the native planet name of *Fesoan* at Memory Beta, since that and their planet map are straight out of Shane's work.

I realize some of the tech data on the ships is either missing or screwed up. I hope to go back and correct this later.

Regards,

- Richard E. Mandel

SPECIAL THANKS TO:

ArcBuilder, Celestra, and StarGen
Stan and Fred Goldstein
Memory Alpha
Memory Beta
Timo Saloniemi
Aridas Sofia
Wikipedia

VISUAL SOURCES:

Reimund Bertrams
Dan Carlson
Mateen Greenway
Greg Jein
Shane Johnson
MGM/UA Entertainment
Mike Okuda
Nightscape Creations
Paramount Pictures
Aridas Sofia
Rick Sternbach
The SpaceArt Archives
Tallguy

CONTACT INFO:

Want to contribute to the *Federation Spaceflight Chronology*?
You can find me on the FRS Online or Star Fleet Network
forums. If you prefer direct contact then you can reach me at:

rtrrodude@yahoo.com

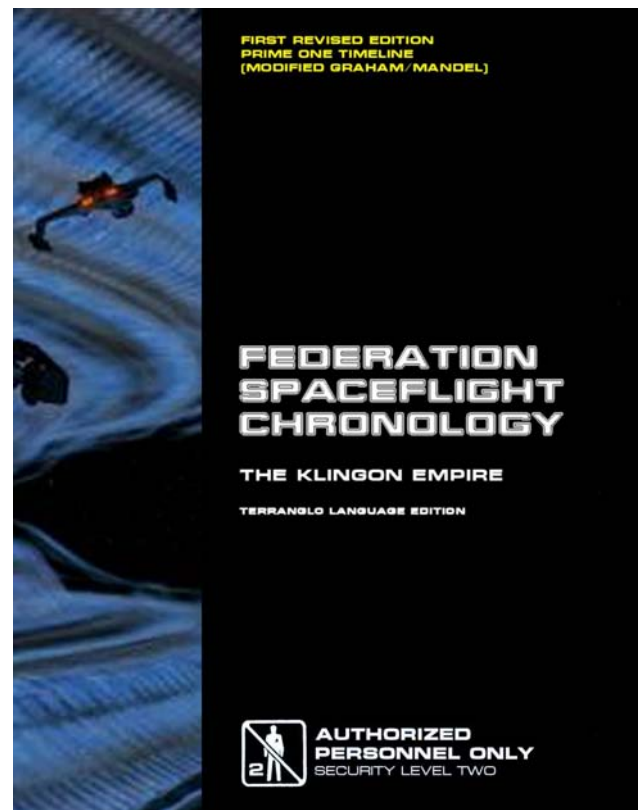
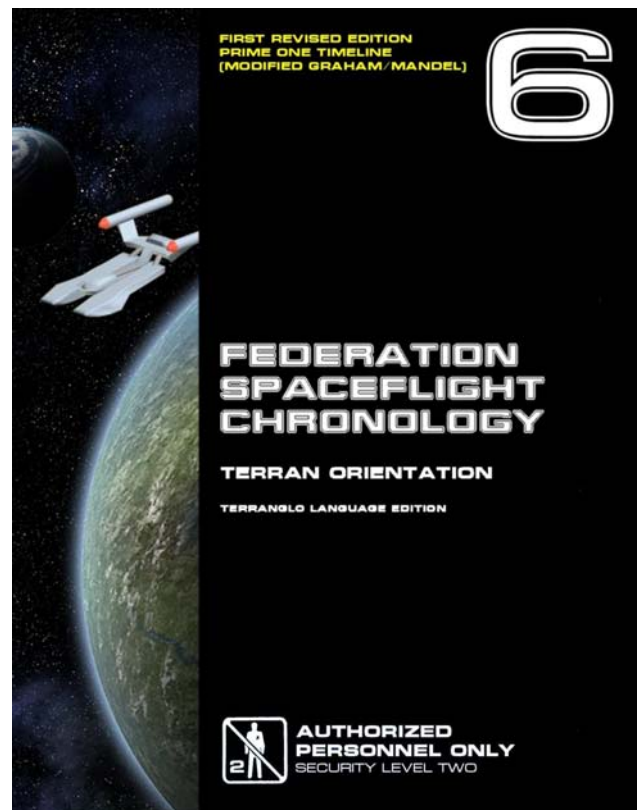

also available

