

ROMULAN SHIP RECOGNITION MANUAL

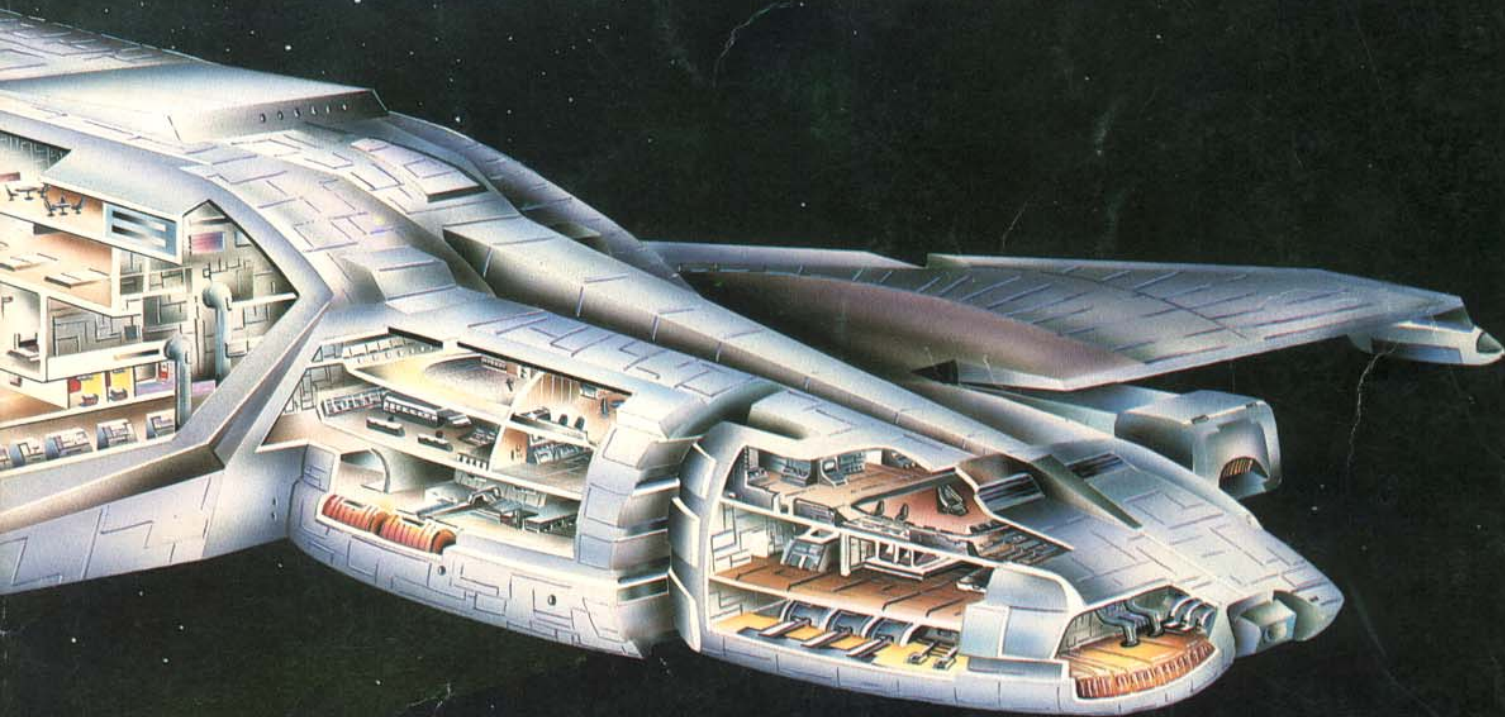

A supplement for use with

STAR TREK[®]
THE ROLE PLAYING GAME





INTELLIGENCE DATA RELIABILITY RATINGS

Class A

Hard data gathered from physical examination.

Class B

Intelligence projection based on repeated scans/encounters over protracted periods. Class A plans available.

Class C

Intelligence projection based on repeated scans/encounters. Class B plans available.

Class D

Intelligence projection based on five or fewer scans/encounters. Class C plans available.

Class E

Speculative projection based on hearsay/transmissions from official/semi-official sources.

Class F

Speculative projection based on hearsay/transmissions from unofficial sources.

CHANGES TO THIS MANUAL

Users of this manual are required to submit changes in the information in this publication pursuant to SFOPS.MAN.307/A45T. Such changes or other comments regarding this publication must be keyed to the specific page, paragraph, and line of text in which the change is recommended. Reasons should be provided for each comment to insure understanding and complete evaluation.

Comments should be prepared using SFRD Form 2028 (Recommended Changes to Publication) and forwarded directly to:

STAR FLEET INTELLIGENCE COMMAND

Assistant Chief Of Staff,
Romulan Sector Intelligence
Olympica, Mars 01.4

FOR AUTHORIZED USE ONLY

Unauthorized use, possession, or disclosure of the contents of this manual is strictly prohibited. All violations are treasonous acts against the United Federation of Planets. Failure to comply with directives regarding the use of this manual will result in life imprisonment, death, or both.

Classified Documents Directive 998.21C

ROMULAN SHIP RECOGNITION MANUAL

INTRODUCTION	3
COMBAT VESSELS	
Assault Ships	
M-4 (Wings Of Justice)	4
M-8 (Nightwing)	5
Battleships	
Z-1 (Nova)	6
Couriers	
CS-2 (Graceful Flyer)	7
Cruisers	
V-1 (Starglider)	8
V-2 (Hunter)	9
V-4 (Wing Of Vengeance)	10
V-5 (Skyfire)	11
V-6 (Gallant Wing)	12
V-7 (Whitewind)	13
V-8 (Bird Of Prey)	14
V-9 (Night Flyer)	15
V-11 (Stormbird)	16
V-20 (Star Seeker)	17
V-27 (Comet Of Destruction)	18
V-30 (Winged Defender)	19
Cutters	
P-2 (Ranajmar)	20
P-3 (Caladan)	21
P-12 (Comilius)	22
Destroyers	
T-2 (Death Talon)	27
T-5 (Fire Swarm)	28
T-10 (Bright One)	29
Escorts	
R-4 (Mularr)	30
Gunboats	
N-8 (Mandukam)	31
Monitors	
Q-1 (Great Defender)	32
Q-4 (Protector)	33
Scouts	
S-3 (Free Flight)	34
S-4 (Swift Wing)	35
S-9 (Wind Carrier)	36
S-11 (Bird Of Prey)	37
SUPPORT VESSELS	
Cargo Transports	
I-4 (Graffler)	38
I-7 (Vespin)	39
Freighters	
J-3 (Starlifter)	40
J-4 (Baydron)	41
J-8 (Moorabbin)	42
Warpshuttles	
H- 4 (Praetor)	43
H-5 (Ras Lovah)	44
REPAIR VESSELS AND FACILITIES	
Tenders	
E-5 (Little Nest)	45
Construction/Repair Facilities	
F-2 (Nestar)	46
ORBITAL AND DEEP – SPACE STATIONS	
Orbital Border Outposts	
X-3 (Aviary)	47
TIME LINES	23
RECOGNITION SILHOUETTES	24

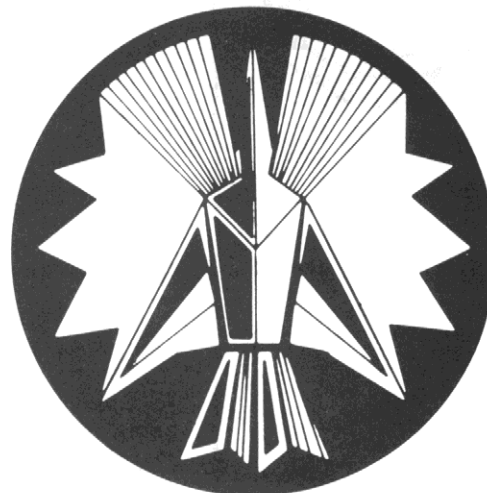

Design

Forest G. Brown

Writing

Forest G. Brown
Wm. John Wheeler

Editorial Staff

Editing
Wm. John Wheeler
Proofreading
Donna Ippolito

Illustration And Cover Art

Dana Knutson

Production Staff

Graphic Design
Jordan Weisman
Layout And Pasteup
Todd F. Marsh
Dana Knutson
Jane Bigos
Typesetting
Karen Vander Mey

STAR TREK is a trademark of Paramount Pictures Corporation.
STAR TREK: The Role Playing Game is published by FASA Corporation under exclusive license from Paramount Pictures Corporation, the trademark owner.
Copyright 1985 Paramount Pictures Corporation.
All Rights Reserved. Printed in the United States of America.

Introduction

THE ROLE OF THE STAR NAVY

The Romulan Star Empire maintains an active navy about three-fourths the size of Star Fleet. This large and modern navy is considered to be of major importance in attaining *The Road To The Stars*, as the Romulans designate their national goals, and in maintaining the security of the Star Empire. The Star Navy has personnel numbering millions and supports extensive production facilities that have been responsible for outputting large quantities of modern, high-firepower weapons during the past few years.

The goals of the Star Empire are being achieved by direct use of military power and by more subtle means as well. In his address to the UFP Intelligence Community Symposium On Romulans, Stardate 2/1902, these latter were described by Adm. Talitha of Andor as follows:

The most prevalent Romulan threats have not been massive military invasions, but a more subtle mix of military, psychological, and political pressures. In light of recent events, it is likely that the Romulans are preparing to come out in the open.

In this context, and in consideration of superpower competition, it is to be assumed that Romulan national goals are hostile to those of the United Federation of Planets.

SCOPE OF THIS MANUAL

This manual describes the major ships of the Star Navy on which enough information exists to give an overview to authorized Star Fleet Intelligence personnel and line officers on a need-to-know basis. An effort has been made to provide a comprehensive and objective presentation, despite the limitations of space. It is designed for general reading and quick reference.

This manual furnishes an historical background of Romulan starships from Stardate 1/8001 to present day, along with discussions of each ship, including its weaknesses and strengths, its known sphere of operations, and such combat data as is available. The overall reliability of the data available for each vessel is noted, as well as the primary information source, the records of which may be consulted if a more detailed briefing is necessary.

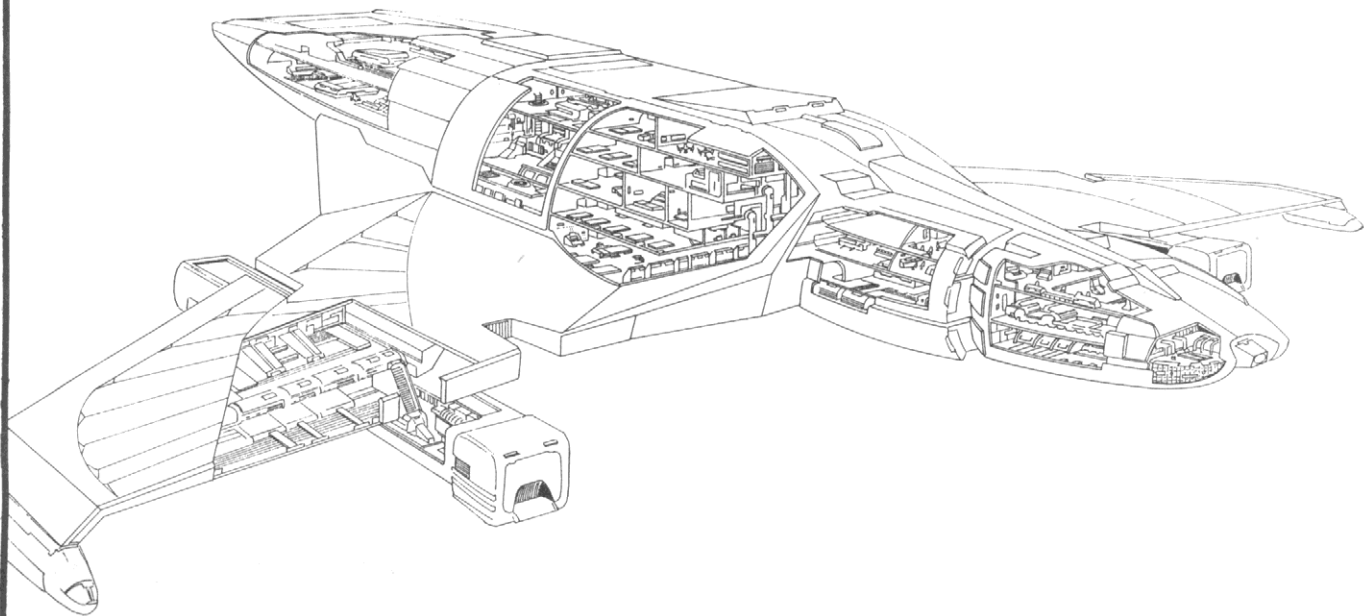



M-4 (Wings Of Justice) Class IX Troop Transport

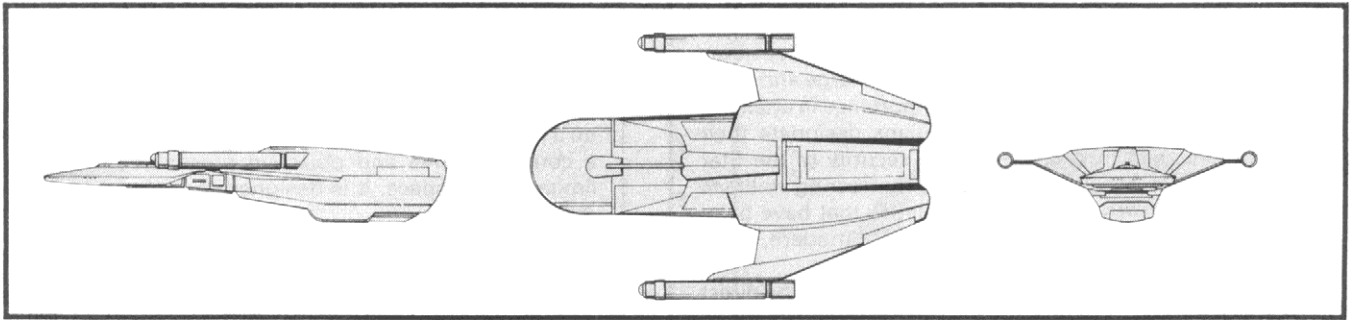

M-4 (Wings Of Justice) CLASS IX TROOP TRANSPORT

Construction Data:

Model Numbers —	Type 1
Date Entering Service —	2/08
Approx. Number Constructed —	150

Hull Data:

Superstructure Points —	14
Damage Chart —	B
Size	
Length —	270 m
Width —	180 m
Height —	50 m
Weight —	126,500 mt
Cargo	
Cargo Units —	6000 SCU
Cargo Capacity —	300,000 mt
Landing Capability —	None

Equipment Data:

Control Computer Type —	R4M
Transporters	
Standard 9-person	8
Combat 20-person	8
Cargo	4
Cloaking Device Type —	None

Other Data:

Crew —	84
Troops —	1800
Shuttlecraft —	6

Engines And Power Data:

Total Power Units Available —	40
Movement Point Ratio	
Unloaded	4/1
Loaded	7/1
Warp Engine Type	
Number —	2
Power Units Available —	18
Stress Charts —	G.L
Maximum Safe Cruising Speed	
Unloaded	Warp 7
Loaded	Warp 4
Emergency Speed	
Unloaded	Warp 9
Loaded	Warp 6
Impulse Engine Type	
Power Units Available —	RID-1 4

Weapons And Firing Data:

Beam Weapon Type	
Beam Weapon Type —	RB-7a
Number —	2
Firing Arcs —	1 port, 1stbd
Firing Chart —	M
Maximum Power —	4
Damage Modifiers	
+3	(1 - 3)
+2	(4 - 9)
+1	(10 - 14)

Shields Data:

Deflector Shield Type —	RSE
Shield Point Ratio —	1/2
Maximum Shield Power —	5

Combat Efficiency:

D-	56.0
WDF-	6.0
	376

Notes:

Known Sphere Of Operation: Conflict zones

Data Reliability: D

Major Data Source: Project Grey Ghost; Klingon Sector Intelligence

The M-4 assault ship, reportedly capable of carrying up to 300,000 metric tons of cargo or 1,800 troops and their equipment, is thought to be the main transport for Romulan ground forces. Introduced about Stardate 2/08, intelligence reports that the vessels have participated in several invasions. Of the more than 150 built, nearly all remain in active service. Intelligence reports show no record of any being sold to the civil sector, and none are known to be operating outside the empire.

The vessel likely is named in reference to the following quote:

The Romulan soldier will lead the way and secure the foundations of the Road to the Stars, for he will be borne on the wings of justice.

*Arenius Triario
Commander*

According to *The Eridam Papers*, this historic statement was made by Commander Triario as the Romulan fleet departed for a great battle with the Corillians. Triario was victorious and returned a hero.

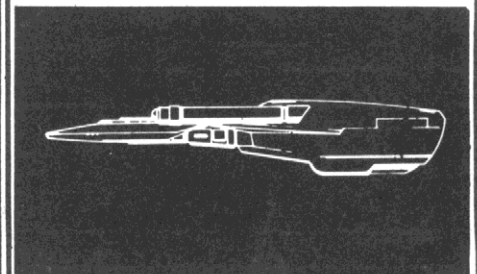



M-8 (Nightwing) Class VIII Assault Ship

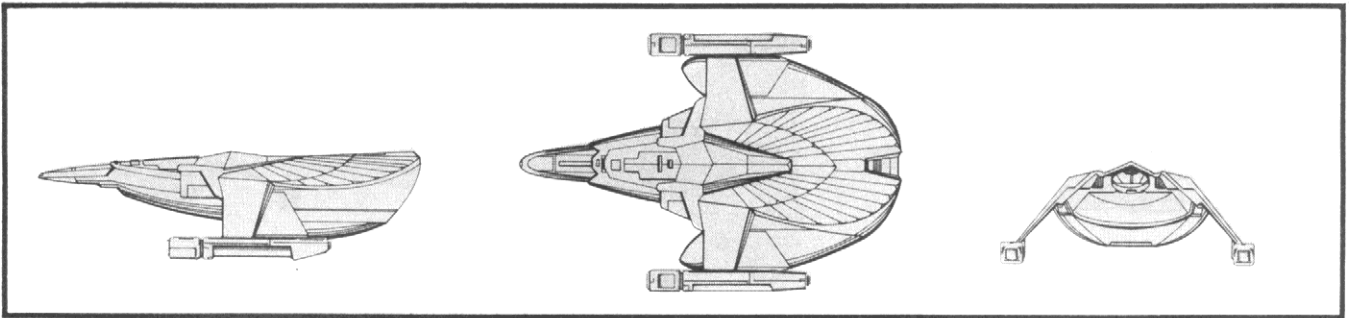

M-8 (Nightwing) CLASS VIII ASSAULT SHIP

Construction Data:

Hull/Ship Numbers —	Type 1
Model Numbers —	2/14
Date Entering Service —	100
Approx. Number Constructed —	

Hull Data:

Superstructure Points —	12
Damage Chart —	B
Size	
Length —	260 m
Width —	172 m
Height —	72 m
Weight —	103,500 mt
Cargo	
Cargo Units —	2000 SCU
Cargo Capacity —	100,000 mt
Landing Capability —	None

Equipment Data:

Control Computer Type —	R4M
Transporters —	
Standard 9-person	3
Combat 20-person	5
Large cargo	3
Cloaking Device Type —	None

Other Data:

Crew —	62
Troops —	700
Shuttlecraft —	4

Engines And Power Data:

Total Power Units Available —	38
Movement Point Ratio —	
Unloaded	3/1
Loaded	4/1
Warp Engine Type —	RWE-1
Number —	2
Power Units Available —	13
Stress Charts —	1 L
Maximum Safe Cruising Speed —	
Unloaded	Warp 7
Loaded	Warp 6
Emergency Speed —	
Unloaded	Warp 8
Loaded	Warp 7
Impulse Engine Type —	RID-3
Power Units Available —	12

Weapons And Firing Data:

Beam Weapon Type —	RB-7a
Number —	2
Firing Arcs —	1 port, 1 stbd
Firing Chart —	M
Maximum Power —	4
Damage Modifiers —	
+3	(1 - 3)
+2	(4 - 9)
+1	(10 - 14)

Shields Data:

Deflector Shield Type —	RSH
Shield Point Ratio —	1/2
Maximum Shield Power —	8

Combat Efficiency:

D-	63.2
WDF-	6.0

379-2

Notes:

Known Sphere Of Operation: Conflict areas

Data Reliability: D

Major Data Source: Project Grey Ghost; Triangle Sector Intelligence

Useful for both troops and cargos, the M-8 assault ships are reported to be the second most important troop carriers in the Romulan Navy. Although the M-8s do not carry as many troops as do the M-4s, they are capable of keeping pace with any fast-moving fleet, as well as being more maneuverable than their counterparts and carrying more effective shields.

Of the approximately 100 built, nearly all are in active service. Approximately 60 vessels of this class are thought to be operating in the civil sector, but, until close scans are possible, this will remain speculation. If the expected confirmation is forthcoming, intelligence will upgrade the Data Reliability to B, for several of these vessels are suspected to be operating in the Triangle.

The class is named from the Romulan *temar vastari* (night flyers), in reference to a large reptilian bird of Hann-rieth, solid black in color. In keeping with its namesake, the assault ships reportedly are painted midnight black.

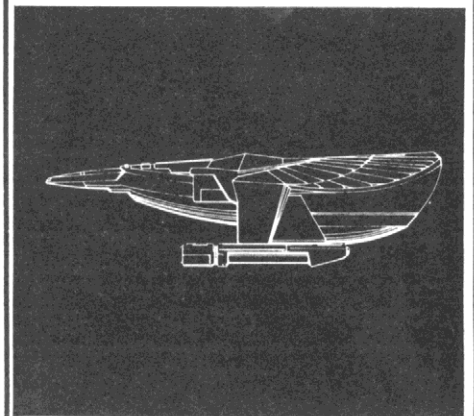



Z-1 (Nova) Class XIII Battleship

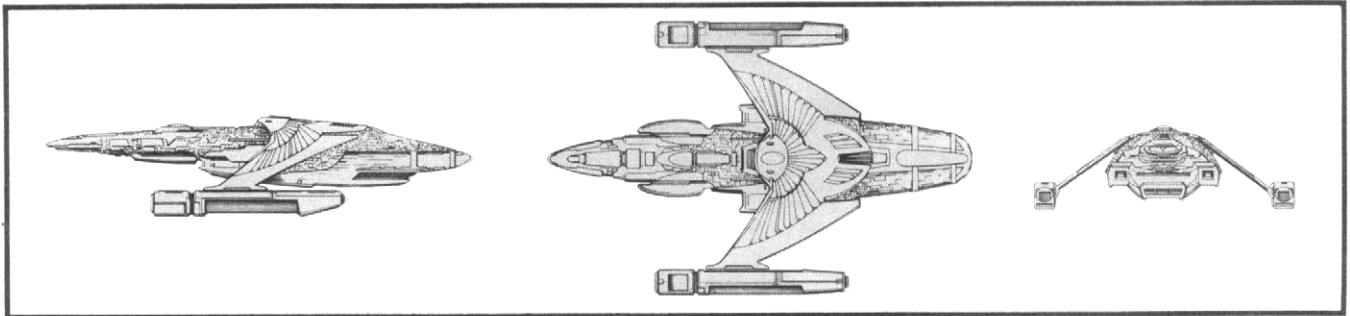

Z-1 (Nova) CLASS XIII BATTLESHIP

Construction Data:

Model Numbers —	Type 1
Date Entering Service —	2/21
Rptd. Number Constructed —	2

Hull Data:

Superstructure Points —	35
Damage Chart —	C
Size	
Length —	400 m
Width —	240 m
Height —	80 m
Weight —	212,000 mt

Cargo

Cargo Units —	400 SCU
Cargo Capacity —	20,000 mt
Landing Capability —	None

Equipment Data:

Control Computer Type —	R6M
Transporters —	
Standard 9-person	6
Emergency 20-person	6
Cargo	2
Cloaking Device Type —	None

Other Data:

Crew —	550
Shuttlecraft —	15

Engines And Power Data:

Total Power Units Available —	76
Movement Point Ratio —	5/1
Warp Engine Type —	RWG-1
Number —	2
Power Units Available —	24
Stress Charts —	G/L
Maximum Safe Cruising Speed —	Warp 6
Emergency Speed —	Warp 8
Impulse Engine Type —	RIF-3
Power Units Available —	28

Weapons And Firing Data:

Beam Weapon Type —	RB-11
Number —	10, in 5 banks of 2
Firing Arcs —	2 p.f., 2 fwd., 2 f.s., 2 s.a., 2, a p
Firing Chart —	V
Maximum Power —	9
Damage Modifiers —	
+3	(1 - 10)
+2	(11 - 16)
+1	(17 - 21)
Missile Weapon Type —	RP-3
Number —	6
Firing Arcs —	1 port, 2 fwd., 1 stbd, 2 aft
Firing Chart —	Q
Power To Arm —	1
Damage —	10

Shields Data:

Deflector Shield Type —	RSO
Shield Point Ratio —	1/3
Maximum Shield Power —	15

Combat Efficiency: D-	103.0
WDF-	112.0

11536

Notes:

Known Sphere Of Operation: Empire interior

Data Reliability: E

Major Data Source: Project Grey
Ghost data acquisition

The Z-1 is the largest, most powerful, and newest ship to enter Romulan Naval service, and the Navy's first battleship to be commissioned. This vessel is reported to incorporate all of the most-modern technology available to the Star Empire, making it a formidable foe.

Commissioned into the home fleet on Stardate 2/2111, according to monitored transmissions, this ship has never been sent into a frontline area. The Z-1 is thought to mount ten of the most powerful disruptors available and six photon torpedo bays, capable of laying down a withering barrage in all directions. It is expected to change the balance of power when it is brought to the borders. Reportedly, four of these ships are nearing completion, and reported production quotas of four per year are not encouraging.

The class is named from the Romulan *morlasasi stejam* (exploding star).

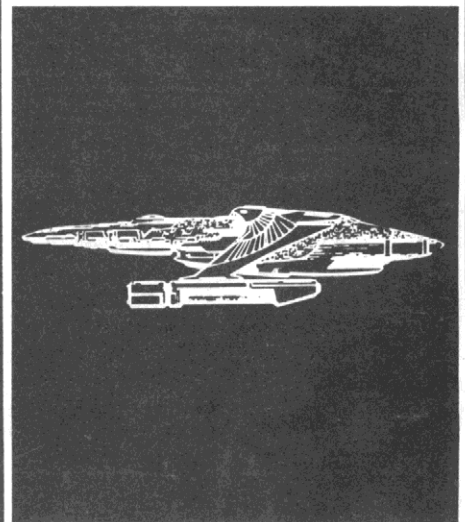



CS-2 (Graceful Flyer) Class V Courier

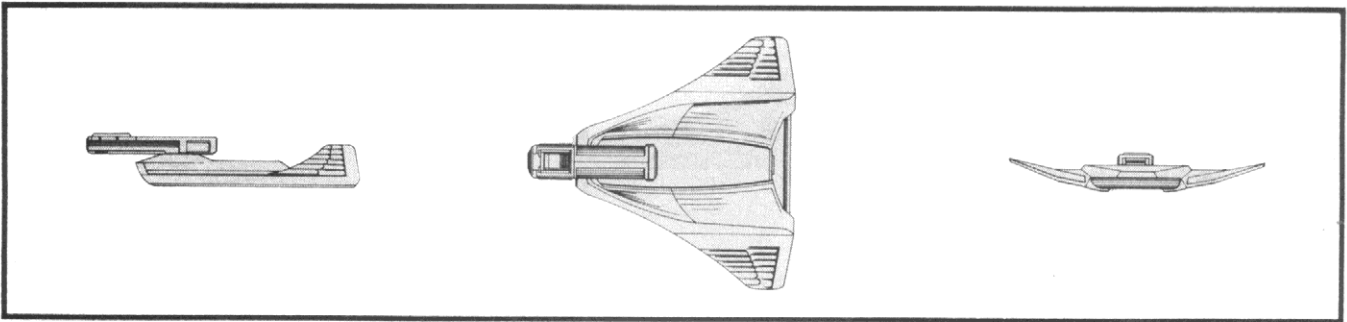

CS-2 (Graceful Flyer) CLASS V COURIER

Construction Data:

	Type 2	Type 6	Type 10
Model Numbers —	1/86	1/98	2/05
Date Entering Service —	120	70	110
Approx. Number Constructed —			

Hull Data:

Superstructure Points —	7	7	8
Damage Chart —	A	A	A
Size			
Length —	164 m	164 m	164 m
Width —	156 m	156 m	156 m
Height —	30 m	31 m	31 m
Weight —	42,100 mt	43,900 mt	46,100 mt
Cargo			
Cargo Units —	24 SCU	24 SCU	24 SCU
Cargo Capacity —	1200 mt	1200 mt	1200 mt
Landing Capability —	Yes	Yes	Yes

Equipment Data:

Control Computer Type —	R2M	R3M	R3M
Transporters —	—	—	—
Standard 9-person	1	1	1
Emergency 20-person	1	1	1

Other Data:

Crew —	118	118	118
Passengers —	30	30	30
Shuttlecraft —	None	None	None

Engines And Power Data:

Total Power Units Available —	20	23	30
Movement Point Ratio —	2/1	2/1	2/1
Warp Engine Type —	RWD-1	RWD-2	RWD-2
Number —	1	1	1
Power Units Available —	15	18	18
Stress Charts —	N/O	O/Q	O/Q
Maximum Safe Cruising Speed —	Warp 7	Warp 7	Warp 7
Emergency Speed —	Warp 8	Warp 8	Warp 8
Impulse Engine Type —	RIB-3	RIB-3	RID-3
Power Units Available —	5	5	12

Weapons And Firing Data:

Beam Weapon Type —	RB-2	RB-7	RB-8
Number —	2	2	2
Firing Arcs —	1fp, 1fs	1fs, 1fp	1fp, 1fs
Firing Chart —	K	J	N
Maximum Power —	2	4	6
Damage Modifiers —	None		
+3	—	—	(1 - 4)
+2	—	(1 - 6)	(5 - 9)
+1	—	(7 - 10)	(10 - 13)

Shields Data:

Deflector Shield Type —	RSD	RSD	RSE
Shield Point Ratio —	1.1	1.1	1.2
Maximum Shield Power —	8	8	8

Combat Efficiency:

D-	36.0	38.0	65.4
WDF-	1.6	4.6	8.2
	57.6	174.8	530.28

Notes:

Known Sphere Of Operation: Empire-wide use

Data Reliability: A

Major Data Source: Type 10 vessel is in Star Fleet possession; captured Romulan data

The ships in this class were used for long-range courier missions for many years. Carrying light armament, they were used extensively along the Federation borders and in the Triangle. Because they can sustain Warp 7 speeds, they have been used as VIP transport throughout the Star Empire.

About Stardate 1/8608, the CS-2 Type 2 was introduced into service to replace the Type 1; though quite suitable for its role, its weapon systems were light, a trend that continued until the introduction of the Type 6 about Stardate 1/9804. This newer model carried an upgraded beam weapon and mounted a more powerful engine; existing vessels of Types 2 through 5 were not refitted, but were relegated to duties within the Empire. Types 7 through 9 showed cosmetic changes to the Type 6, but about Stardate 2/0510, the Type 10 was introduced with new-style shields and more powerful weapons and engines. Vessels in this class were put into the reserve fleets about Stardate 2/14.

Of the approximately 300 built, about 150 currently serve in the reserve fleet. It is known that at least 90 have been sold to the private sector; one Type 5, one Type 7, and one Type 10 operate exclusively in the Triangle.

Named for the *verelan vastarum* (graceful flyer), a Romulan bird known for its ability to glide gracefully for hours at a time, these ships are common along the borders of the Star Empire, though they normally are not involved in military missions.

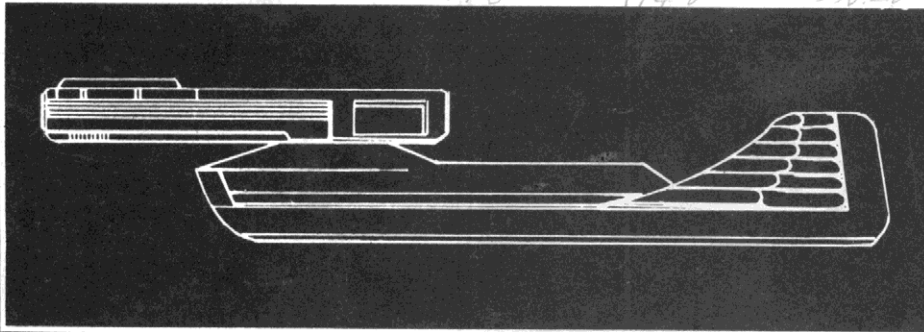



V-1 (Starglider) Class V Cruiser

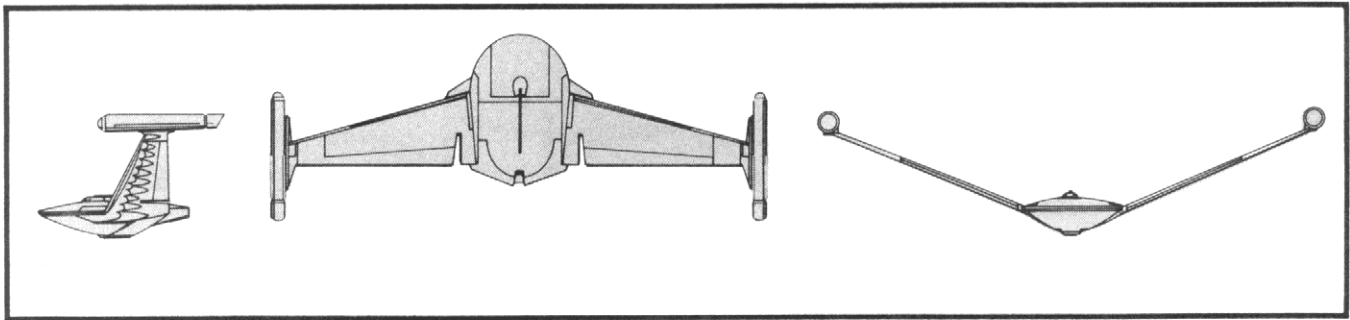

V-1 (Starglider) CLASS V CRUISER

Construction Data:

	Type 1	Type 2
Model Numbers —	1/88	1/98
Date Entering Service —	70	40
Approx. Number Constructed —		

Hull Data:

	Type 1	Type 2
Superstructure Points —	10	11
Damage Chart —	C	C
Size		
Length —	60 m	60 m
Width —	162 m	162 m
Height —	40 m	40 m
Weight —	48,700 mt	52,000 mt
Cargo		
Cargo Units —	120 SCU	120 SCU
Cargo Capacity —	6000 mt	6,000 mt
Landing Capability —	Yes	Yes

Equipment Data:

	Type 1	Type 2
Control Computer Type —	R3M	R3M
Transporters —		
Standard 9-person	1	1
Emergency 20-person	1	1
Small cargo	1	1

Other Data:

	Type 1	Type 2
Crew —	135	135
Passengers —	16	16
Shuttlecraft —	None	None

Engines And Power Data:

	Type 1	Type 2
Total Power Units Available —	20	23
Movement Point Ratio —	2/1	2/1
Warp Engine Type —	RWD-2	RWD-2
Number —	1	1
Power Units Available —	18	18
Stress Charts —	O/Q	O/Q
Maximum Safe Cruising Speed —	Warp 7	Warp 7
Emergency Speed —	Warp 8	Warp 8
Impulse Engine Type —	RIB-1	RIB-3
Power Units Available —	2	5

Weapons And Firing Data:

	Type 1	Type 2
Beam Weapon Type —	RB-2	RB-7
Number —	6	6
Firing Arcs —	1 p/a, 4 fwd, 1 s/a	1 p/a, 4 fwd, 1 s/a
Firing Chart —	K	J
Maximum Power —	2	4
Damage Modifiers —	None	(1 - 6)
+2		(7 - 10)
+1		

Shields Data:

	Type 1	Type 2
Deflector Shield Type —	RSD	RSG
Shield Point Ratio —	1:1	1:1
Maximum Shield Power —	8	13

Combat Efficiency:

	Type 1	Type 2
D-	40.3	50.7
WDF-	4.8	13.8

Notes:

Known Sphere Of Operation:
Romulan interior

Data Reliability: D

Major Data Source: Project Grey
Ghost

Soon after its introduction into exploratory service, the V-1 vessels were found to be unsuitable for their mission. The cramped quarters and work areas would not permit extensive onboard research and testing, which meant that the ships were compelled to land on most worlds to carry out their studies. Not only were such atmospheric operations difficult, but the exposure of the entire ship to unknown environments put them in constant danger. These risks were unacceptable to the Romulan High Command, so the class was reassigned as cruisers to supplement the fleets. It evidently saw no greater success in this role, for it was removed from active service about Stardate 2/0806. The Type 2 mounted better, bank-mounted weaponry and a more powerful impulse drive.

Of the approximately 100 built, half are assigned to reserve fleets. Eighteen have been sold to the civil sector, where they are used as private research vessels; two operate exclusively within the Triangle.

The class is named for *Vadaso Stelri* (glider in the stars), an asteroid in the Romulan home system. Ancient legend is reported to state that this glider was a returning message from the gods, directing the Romulans to follow it on its road through the stars.

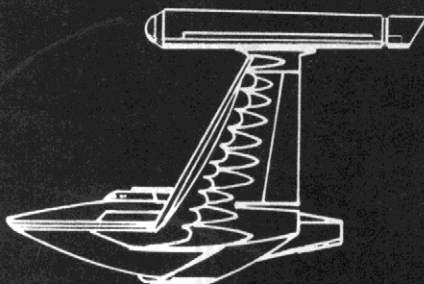



V-2 (Hunter) Class VII Cruiser

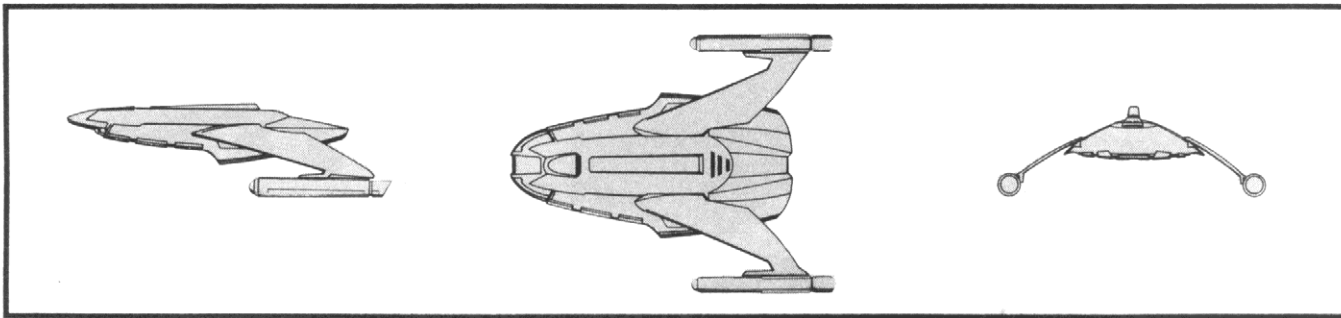

V-2 (Hunter) CLASS VII CRUISER

Construction Data:

Model Numbers—	Type 2	Type 5
Date Entering Service—	1/91	2/00
Approx. Number Constructed—	40	30

Hull Data:

Superstructure Points—	14	14
Damage Chart—	C	C
Size—		
Length—	150 m	153 m
Width—	118 m	118 m
Height—	40 m	40 m
Weight—	88,600 mt	88,700 mt
Cargo—		
Cargo Units—	240 SCU	125 SCU
Cargo Capacity—	12,000 mt	6250 mt
Landing Capability—	None	None

Equipment Data:

Control Computer Type—	R4M	R4M
Transporters—		
Standard 9-person	3	3
Emergency 20-person	2	2
Cargo	1	1
Cloaking Device Type—	None	None

Other Data:

Crew—	220	225
Shuttlecraft—	2	2

Engines And Power Data:

Total Power Units Available—	35	37
Movement Point Ratio—	3/1	3/1
Warp Engine Type—	RWD-1	RWD-1
Number—	2	2
Power Units Available—	16	16
Stress Charts—	O/O	O/O
Maximum Safe Cruising Speed—	Warp 6	Warp 6
Emergency Speed—	Warp 7	Warp 7
Impulse Engine Type—	RIB-2	RIB-3
Power Units Available—	3	5

Weapons And Firing Data:

Beam Weapon Type—	RB-4	RB-4
Number—	6	6
Firing Arcs—	2 f.p., 2 f.s., 2 aft	2 f.p., 2 f.s., 2 aft
Firing Chart—	J	J
Maximum Power—	6	6
Damage Modifiers—		
+3	(1 - 2)	(1 - 2)
+2	(3 - 6)	(3 - 6)
+1	(7 - 10)	(7 - 10)
Plasma Weapon Type—	None	RPL-1
Number—		1
Firing Arcs—		1wd
Firing Chart—		E
Power To Arm—		10
Damage—		See Chart

Shields Data:

Deflector Shield Type—	RSG	RSJ
Shield Point Ratio—	1.1	1.1
Maximum Shield Power—	12	14

Combat Efficiency:

D-	54.0	59.5
WDF-	12.8	23.1

5973 1474.45

Notes:

Known Sphere Of Operation:
Romulan interior

Data Reliability: F

Major Data Source: Project Grey
Ghost data acquisition

The V-2 Class, first encountered by Project Grey Ghost, is believed to have been built for research missions, much like the Federation research cruisers are. Reportedly, spacious laboratory facilities and shuttlebays for cargo storage make this ship an oddity in the Romulan navy. Several recent combat encounters with the Klingons and forces to the coreward have proved the vessel to be undergunned and unsuitable for combat.

Several attempts were made to up-gun the ship, with the last being the introduction of the Type 5, approximately Stardate 2/00. This version is reported to carry a small plasma weapon and improved impulse drive system. Even so, the V-2 did not prove popular, and has been replaced by the V-5 and V-6 cruisers.

Of the approximately 70 Hunters built, about half are reported to be in reserve fleets and about 20 are reportedly working as research vessels for private firms. This vessel has not yet been scanned at close range, and plans given are highly speculative.

The ship is named from the Romulan *hathos* (hunter), likely in reference to its mission in the Exploration Division.

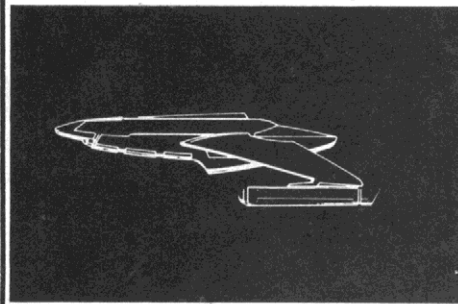



V-4 (Wing Of Vengeance) Class VI Cruiser

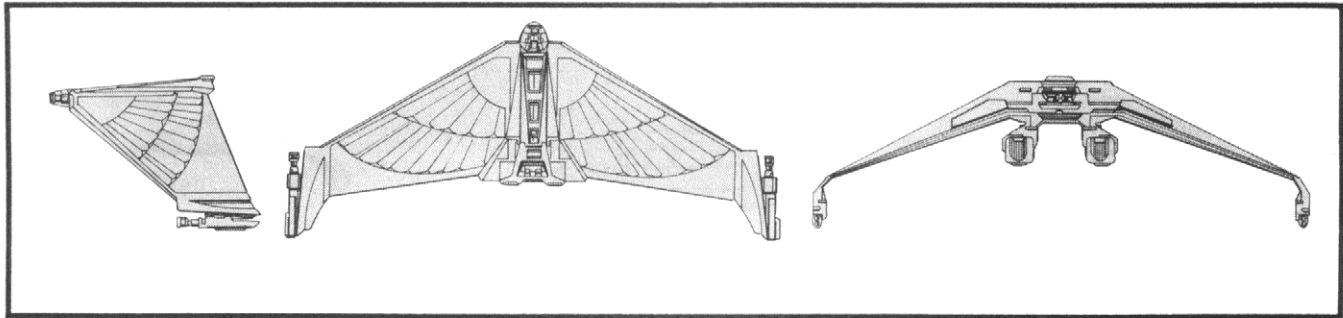

V-4 (Wing Of Vengeance) CLASS VI CRUISER

Construction Data:

Model Numbers —	Type 1	Type 2
Date Entering Service —	1/90	1/94
Approx. Number Constructed —	80	60

Hull Data:

Superstructure Points —	12	13
Damage Chart —	C	C
Size		
Length —	85 m	85 m
Width —	195 m	195 m
Height —	60 m	60 m
Weight —	65,600 mt	66,800 mt

Cargo

Cargo Units —	80 SCU	80 SCU
Cargo Capacity —	4000 mt	4000 mt
Landing Capability —	None	None

Equipment Data:

Control Computer Type —	R4M	R4M
Transporters —		
Standard 9-person	2	2
Emergency 20-person	2	2
Cargo	1	1

Other Data:

Crew —	160	160
Shuttlecraft —	2	2

Engines And Power Data:

Total Power Units Available —	32	35
Movement Point Ratio —	3/1	3/1
Warp Engine Type —	RWC-2	RWC-2
Number —	2	2
Power Units Available —	15	15
Stress Charts —	N/Q	N/Q
Maximum Safe Cruising Speed —	Warp 6	Warp 6
Emergency Speed —	Warp 7	Warp 7
Impulse Engine Type —	RIB-1	RIB-3
Power Units Available —	2	5

Weapons And Firing Data:

Beam Weapon Type —	RB-4	RB-8
Number —	6	6
Firing Arcs —	2 p. a., 2 fwd. 2 s. a.	2 p. a., 2 fwd. 2 s. a.
Firing Chart —	J	N
Maximum Power —	6	6
Damage Modifiers —		
+3	(1 - 2)	(1 - 4)
+2	(3 - 6)	(5 - 9)
+1	(7 - 10)	(10 - 13)

Shields Data:

Deflector Shield Type —	RSG	RSJ
Shield Point Ratio —	1.1	1.1
Maximum Shield Power —	13	14

Combat Efficiency:

D-	50.7	55.1
WDF-	19.2 <i>973.44</i>	24.6 <i>24.6</i>

Notes:

Known Sphere Of Operation: Empire interior.

Data Reliability: D

Major Data Source: Klingon sector intelligence

The V-4 class has, by far, the most unusual design to come from Romulan engineers; fashioned like a giant wing, it was created not only for aesthetics but for combat. When the vessels were first introduced, they were intended to lead an expansion effort, but the war between the Klingons and Federation caused them to be sent to patrol the Klingon border. The Type 2 mounted a more powerful impulse drive system and improved disruptors, which accounted for its greater combat efficiency.

The V-4s were painted by crewmembers in a variety of patterns. These ships, though popular with their crews, were removed from service sometime after Stardate 2/16 for more powerful designs. Of the approximately 135 built, about 65 are in reserve fleets. Six are reported to be used as training vessels, and two are used as spaceborn museums, one each stationed at Remus and at Corill. Eighteen are known to be operating in the civil sector.

On Stardate 1/9611, nine of these vessels are known to have been sent into the Triangle to liberate a small system from the Klingons. The Romulans pressed the attack against the three D-7s protecting the system, immediately destroying two and driving the other away. Flushed with victory, the Romulan commander sent five of his group after the fleeing enemy, but they encountered nine D-7s and three D-10s arriving to reinforce the area. The Romulans flew into a classic trap laid by the Klingon battlegroup, and three were destroyed before getting off one shot. The remaining Romulans miraculously crippled four of the Klingon vessels before one was crippled itself and the remaining vessel fled. The Klingons abandoned the effort and withdrew from the area.

This battle caused a stir in the Klingon High Command, as the ship had never before been encountered. Because the stories told of its abilities were inflated to make the Klingon fleet commander look good, the V-4s enjoyed an undeserved notoriety amongst the Klingons for many years.

The class is named from the Romulan *vastam cl'vangas* (wing of vengeance), in reference to the vessel's combat capabilities.

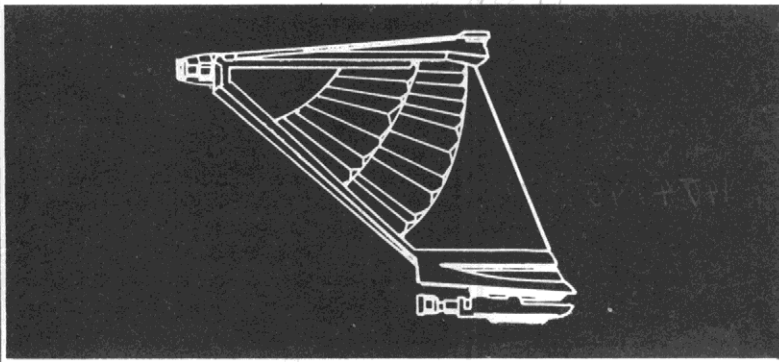



V-5 (Skyfire) Class VII/VIII Cruiser

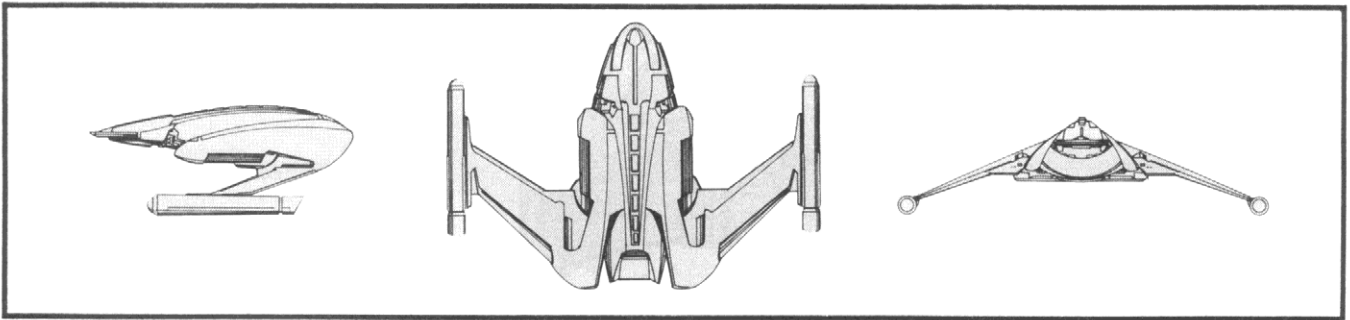

V-5 (Skyfire) CLASS VII/VIII CRUISER

Construction Data:

Model Numbers —	Type 1	Type 2
Ship Class —	VII	VIII
Date Entering Service —	1/96	2/00
Approx. Number Constructed —	40	40

Hull Data:

Superstructure Points —	17	18
Damage Chart —	B	B
Size		
Length —	160 m	160 m
Width —	233 m	233 m
Height —	60 m	60 m
Weight —	93,500 mt	114,300 mt
Cargo		
Cargo Units —	170 SCU	190 SCU
Cargo Capacity —	6500 mt	8500 mt
Landing Capability —	None	None

Equipment Data:

Control Computer Type —	R4M	R4M
Transporters —		
Standard 9-person	3	3
Emergency 20-person	2	2
Cargo	1	1
Cloaking Device Type —	RCC	RCC
Power Requirement —	15	15

Other Data:

Crew —	270	270
Shuttlecraft —	2	2

Engines And Power Data:

Total Power Units Available —	35	38
Movement Point Ratio —	3/1	3/1
Warp Engine Type —	RWD-1	RWE-1
Number —	2	2
Power Units Available —	16	13
Stress Charts —	O/O	I/L
Maximum Safe Cruising Speed —	Warp 6	Warp 7
Emergency Speed —	Warp 7	Warp 8
Impulse Engine Type —	RIB-2	RID-3
Power Units Available —	3	12

Weapons And Firing Data:

Beam Weapon Type —	RB-5	RB-5
Number —	4	4
Firing Arcs —	2 p/a, 2 s/a	2 p/a, 2 s/a
Firing Chart —	V	V
Maximum Power —	5	5
Damage Modifiers —		
+3	(1 - 10)	(1 - 10)
+2	(11 - 16)	(11 - 16)
+1	(17 - 21)	(17 - 21)
Beam Weapon Type —	RB-6	
Number —	2	
Firing Arcs —	fwd	
Firing Chart —	T	
Maximum Power —	6	
Damage Modifiers —	+2	(1 - 18)
Missile Weapon Type —	None	RPL-1
Number —		1
Firing Arcs —		fwd
Firing Chart —		E
Power To Arm —		10
Damage —		See Chart

Shields Data:

Deflector Shield Type —	RSJ	RSJ
Shield Point Ratio —	1.1	1.1
Maximum Shield Power —	14	13

Combat Efficiency: D-	61.3	61.7
WDF-	43.8	28.4

2684-99 1792-28

Notes:

Known Sphere Of Operation:
Romulan interior

Data Reliability: D

Major Data Source: Project Grey Ghost; Klingon Sector Intelligence

The V-5 Class, apparently brought into service to supplement the V-2 Class, combines the need for a military vessel with that of a research vessel. Though it reportedly is quite capable for combat roles in which the V-2 is a failure, it fills its research roles less well. The Type 1 mounted an impressive array of disruptors with very good fields of fire. The Type 2, introduced about Stardate 2/00, saw the removal of the forward firing disruptors in favor of a bow-mounted plasma weapon, but this version did not prove to be as combat-efficient as the earlier model and has not been reported in any great numbers.

Of the approximately 80 built, about 50 are assigned to reserve fleets. Several are used as training vessels, and eight are reported to be in use as private research vessels or cruisers.

The class is named from the Romulan *ralaaram ocala* (fire from the sky), in reference to its military capabilities.

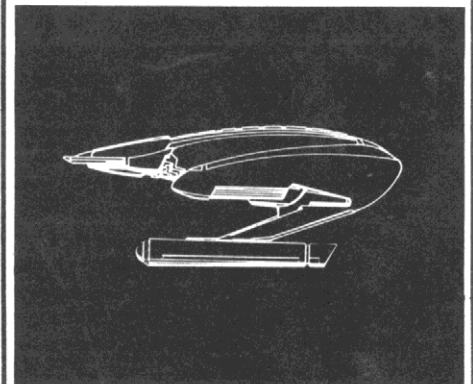



V-6 (Gallant Wing) Class X/XII Cruiser

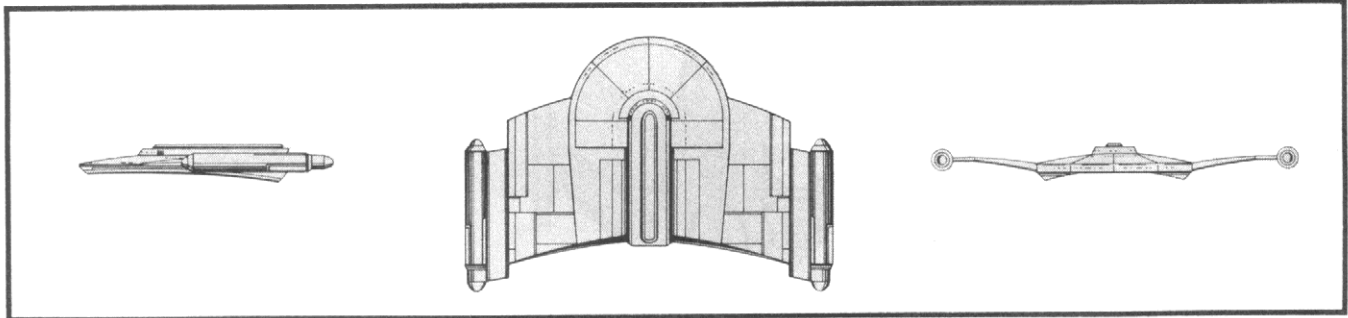

V-6 (Gallant Wing) CLASS X/XII CRUISER

Construction Data:

	Type 1	Type 5	Type 7
Model Numbers —	X	X	XII
Ship Class —	2/09	2/11	2/16
Date Entering Service —	30	50	20
Approx. Number Constructed —			

Hull Data:

	Type 1	Type 5	Type 7
Superstructure Points —	20	22	26
Damage Chart —	B	B	B
Size			
Length —	172 m	172 m	172 m
Width —	250 m	252 m	252 m
Height —	47 m	48 m	48 m
Weight —	140,500 mt	144,000 mt	190,000 mt
Cargo			
Cargo Units —	250 SCU	250 SCU	250 SCU
Cargo Capacity —	12,500 mt	12,500 mt	12,500 mt
Landing Capability —	None	None	None

Equipment Data:

	Type 1	Type 5	Type 7
Control Computer Type —	R5M	R5M	R5M
Transporters —			
Standard 9-person	4	4	4
Emergency 20-person	2	2	2
Cargo	2	2	2
Cloaking Device Type —	RCD	RCD	RCE
Power Requirement —	22	22	38

Other Data:

	Type 1	Type 5	Type 7
Crew —	300	300	300
Shuttlecraft —	2	2	4

Engines And Power Data:

	Type 1	Type 5	Type 7
Total Power Units Available —	40	40	52
Movement Point Ratio —	4/1	4/1	4/1
Warp Engine Type —	RWF-1	RWF-1	RWG-1
Number —	2	2	2
Power Units Available —	18	18	24
Stress Charts —	G/L	G/L	G/L
Maximum Safe Cruising Speed —	Warp 7	Warp 7	Warp 7
Emergency Speed —	Warp 9	Warp 9	Warp 9
Impulse Engine Type —	RID-1	RID-1	RID-1
Power Units Available —	4	4	4

Weapons And Firing Data:

	Type 1	Type 5	Type 7
Beam Weapon Type —	RB-6	RB-9	RB-9
Number —	6, in 3 banks of 2	6, in 3 banks of 2	6, in 3 banks of 2
Firing Arcs —	2 p.f., 2 fwd., 2 f.s.	2 p.f., 2 fwd., 2 f.s.	2 p.f., 2 fwd., 2 f.s.
Firing Chart —	T	W	W
Maximum Power —	5	6	6
Damage Modifiers —			
+3	—	(1 - 8)	(1 - 8)
+2	(1 - 18)	(9 - 16)	(9 - 16)
+1	—	(17 - 20)	(17 - 20)
Plasma Weapon Type —	RPL-2	RPL-2	RPL-2
Number —	1	1	1
Firing Arcs —	fwd	fwd	fwd
Firing Chart —	M	M	M
Power To Arm —	15	15	15
Damage —	See Chart	See Chart	See Chart

Shields Data:

	Type 1	Type 5	Type 7
Deflector Shield Type —	RSN	RSO	RSO
Shield Point Ratio —	1/2	1.3	1.3
Maximum Shield Power —	15	15	15

Combat Efficiency:

	Type 1	Type 5	Type 7
D-	78.6	96.0	113.7
WDF-	62.8	75.4	75.4
	4936-08	7238-4	8572-98

Notes:

Known Sphere Of Operation: Empire-wide use

Data Reliability: A

Major Data Source: Combat reports

The V-6 Class was considered to be the ultimate replacement to fill the need for both a military vessel and a research vessel. Designed much like Star Fleet research cruisers, they are well-equipped for research duties for combat.

At the time of their introduction about Stardate 2/09, they were the most powerful ships in the fleet. The Type 1 mounted six of the most powerful disruptors available and the RPL-2 plasma weapon. Although these vessels never saw combat with any Federation ships, it is speculated that this model would have been an even match for a *Constitution* Class cruiser.

With the Type 5, introduced about Stardate 2/11, the combat efficiency improved because its more powerful disruptors, more efficient shields, and stronger superstructure. At this time, all Type 1s were recalled for refitting to the new configuration, and, by Stardate 2/13, this process had been completed. The Type 5 remained in service until about Stardate 2/22, when all had been converted to the Type 7.

The Type 7, introduced on Stardate 2/1607, mounted improved engines and was structurally improved. Vessels of this type are expected to remain a mainstay of the active Navy.

Of the approximately 100 V-6s built, nearly all remain in active service. One operates as a private research vessel, appearing infrequently in the Triangle.

The class is named from the Romulan *s'ten vastam* (gallant wing).



V-7 (Whitewind) Class IX/X Cruiser

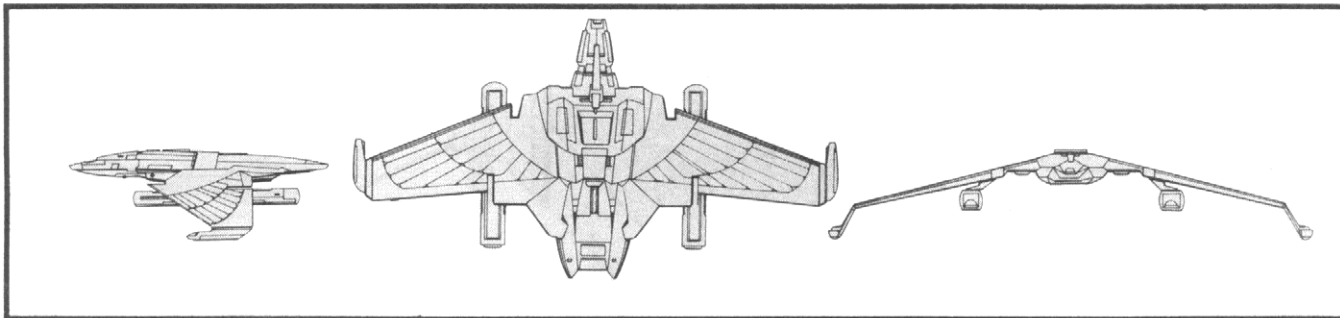

V-7 (Whitewind) CLASS IX/X CRUISER

Construction Data:

Model Numbers —	Type 1	Type 3
Ship Class —	IX	X
Date Entering Service —	2/12	2/17
Approx. Number Constructed —	60	28

Hull Data:

Superstructure Points —	18	18
Damage Chart —	B	B
Size		
Length —	140 m	140 m
Width —	260 m	260 m
Height —	48 m	48 m
Weight —	139,500 mt	144,400 mt
Cargo		
Cargo Units —	320 SCU	320 SCU
Cargo Capacity —	16,000 mt	16,000 mt
Landing Capability —	None	None

Equipment Data:

Control Computer Type —	R4M	R6M
Transporters —		
Standard 9-person	4	4
Emergency 20-person	4	4
Cargo	2	2
Cloaking Device Type —	RCC	RCD
Power Requirement —	15	22

Other Data:

Crew —	320	322
Shuttlecraft —	6	6

Engines And Power Data:

Total Power Units Available —	44	44
Movement Point Ratio —	4/1	4/1
Warp Engine Type —	RWF-1	RWF-1
Number —	2	2
Power Units Available —	18	18
Stress Charts —	G/L	G/L
Maximum Safe Cruising Speed —	Warp 7	Warp 7
Emergency Speed —	Warp 9	Warp 9
Impulse Engine Type —	RID-2	RID-2
Power Units Available —	8	8

Weapons And Firing Data:

Beam Weapon Type —	RB-5	RB-5
Number —	4, in 2 banks of 2	4, in 2 banks of 2
Firing Arcs —	2 p.f., 2 f.s.	2 p.f., 2 f.s.
Firing Chart —	V	V
Maximum Power —	5	5
Damage Modifiers —		
+3	(1 - 10)	(1 - 10)
+2	(11 - 16)	(11 - 16)
+1	(17 - 21)	(17 - 21)
Beam Weapon Type —		RB-9
Number —	—	2, in a bank
Firing Arcs —	—	fwd
Firing Chart —	—	W
Maximum Power —	—	6
Damage Modifiers —		
+3	—	(1 - 8)
+2	—	(8 - 16)
+1	—	(17 - 20)
Missile Weapon Type —	None	RP-2
Number —	—	3
Firing Arcs —	—	2 fwd, 1 aft
Firing Chart —	—	H
Power To Arm —	—	1
Damage —	—	8
Plasma Weapon Type —	RPL-2	None
Number —	1	—
Firing Arcs —	fwd	—
Firing Chart —	M	—
Power To Arm —	15	—
Damage —	See Chart	—

Shields Data:

Deflector Shield Type —	RSK	RSL
Shield Point Ratio —	1/2	1/3
Maximum Shield Power —	13	14

Combat Efficiency: D/WDF-	79.6/45.0	88.5/49.8
---------------------------	-----------	-----------

Notes:

Known Sphere Of Operation: Klingon borders

Data Reliability: C

Major Data Source: Project Grey Ghost

Like their counterparts in the V-6 Class, the V-7s were designed for multiple roles, with spacious interiors and complete onboard research facilities.

The Type 1 entered service about Stardate 2/12 and is still being produced as a support ship, even though it is not as efficient in combat as later models. Mounting the RPL-2 plasma weapon and a cloaking device, the Type 1 is capable of operating alone.

The Type 3, introduced about Stardate 2/17, is the preferred model of the class. It mounts two additional disruptors and three photon torpedoes, and it has more efficient shields.

Of the approximately 80 V-7s built, nearly all remain in active service. Current production of the Whitewind is estimated at six per year.

The aft weaponry of the V-7s has set the standard for the Romulan Navy, as exemplified by this Project Grey Ghost report of an incident between two V-7s and two Klingon L-9 Class frigates. The V-7s, investigating asteroid clusters, detected the Klingons as they approached. Both V-7s cloaked and deployed. As the unsuspecting Klingons began surveying the asteroids, the V-7s decloaked and opened fire, only to have the Klingons disappear from view and sensor, obviously taking advantage of cloaking capabilities acquired in the technological exchange. In the waiting game that followed, all four ships remained cloaked and invisible to sensors for several hours. Finally, one of the Klingon commanders became impatient and attempted to warp away from the area. Unfortunately, his path of departure resulted in a collision and catastrophic explosion. The remaining ships immediately decloaked, only to find themselves lying aft to aft, which put the Klingon at a disadvantage because of its lack of torpedoes to the rear. It suffered serious damage and surrendered to the Romulan commander, who allowed the Klingon to leave after surrendering the cloaking device.

The class is named for a meteorological disturbance peculiar to Remus. As described in *The Eridam Papers*, twice per Remus year, a hot wind blows across the northern hemisphere for as long as five days. Mineral particles from the western cliffs are borne aloft by the winds, and, at night, their phosphorescence causes the hemisphere-wide nightglow that gives the weather phenomenon its name *aye mosaram* (white wind).



V-8 (Bird Of Prey) Class VI Cruiser

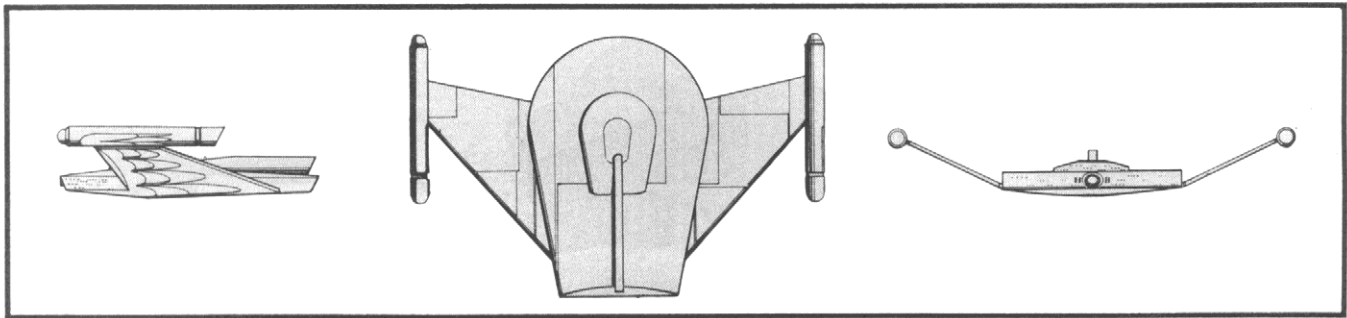

V-8 (Bird Of Prey) CLASS VI CRUISER

Construction Data:		
Model Numbers —	Type 1	Type 4
Date Entering Service —	2/00	2/08
Approx. Number Constructed —	21	73
Hull Data:		
Superstructure Points —	15	15
Damage Chart —	B	B
Size		
Length —	136 m	136 m
Width —	199 m	199 m
Height —	47 m	47 m
Weight —	67,100 mt	68,000 mt
Cargo		
Cargo Units —	48 SCU	48 SCU
Cargo Capacity —	2400 mt	2400 mt
Landing Capability —	None	None
Equipment Data:		
Control Computer Type —	R4M	R4M
Transporters —		
Standard 9-person	1	1
Emergency 20-person	1	1
Cargo	1	1
Cloaking Device Type —	RCC	RCC
Power Requirement —	15	15
Other Data:		
Crew —	150	150
Shuttlecraft —	None	None
Engines And Power Data:		
Total Power Units Available —	26	28
Movement Point Ratio —	3/1	3/1
Warp Engine Type —	RWC-1	RWC-1
Number —	2	2
Power Units Available —	12	12
Stress Charts —	M/P	M/P
Maximum Safe Cruising Speed —	Warp 4	Warp 4
Emergency Speed —	Warp 6	Warp 6
Impulse Engine Type —	RIB-1	RIC-2
Power Units Available —	2	4
Weapons And Firing Data:		
Beam Weapon Type —		
Number —	RB-4	RB-6
Firing Arcs —	1	2
Firing Chart —	port fwd/stbd	port fwd/stbd
Maximum Power —	J	T
Damage Modifiers —	6	6
+3	(1 - 2)	-
+2	(3 - 6)	(1 - 18)
+1	(7 - 10)	-
Plasma Weapon Type —		
Number —	RPL-2	RPL-2
Firing Arcs —	1	1
Firing Chart —	fwd	fwd
Power To Arm —	M	M
Damage —	15	15
	See Chart	See Chart
Shields Data:		
Deflector Shield Type —	RSE	RSH
Shield Point Ratio —	1.2	1.2
Maximum Shield Power —	8	11
Combat Efficiency:		
D-	57.5	63.5
WDF-	21.4	32.0

Notes:

Known Sphere Of Operation: Triangle; Romulan interior

Data Reliability: A

Major Data Source: Combat reports; Triangle Sector Intelligence

On Stardate 2/0710, a V-8 was encountered by a Star Fleet cruiser patrolling the Neutral Zone, the first such contact in over 100 years and the very first visual contact with a Romulan war vessel. The incursion into Federation space obviously was intended to test UFP defenses, and the V-8 destroyed several listening posts and bases before being heavily damaged by the Federation vessel and self-destructing to avoid capture. Because of this incident, and because these ships were encountered in increasing numbers afterward, this vessel, more than any other, has been identified with Romulan military actions. For many years, these vessels were believed to be the mainstay of the Romulan fleet, but improved intelligence reveals that this was a misconception.

The vessel was designed to carry the RPL-2 plasma weapon; because of its size and bulk, the Type 1 ships, 136 meters long, actually were built around the 110-foot-long weapon. The other major feature of the Type 1 was the use of new shielding technology. The Type 4, with upgraded disruptors, was introduced to overcome the inadequate firepower of earlier models.

Of the approximately 100 ships built, about 40 are assigned to reserve fleets. Six have been modified and sold to the civil sector, including two Type 1s, one each of Type 2 and Type 3, and two Type 4s, all of which operate in and out of the Triangle.

The class is named for the Romulan *vas hatham* (bird of prey), in reference to a huge, flying predator, reportedly native to Romulus, but so revered that they have been transplanted to several of the conquered worlds in the empire. Living for nearly 100 years, these avians can reach nearly giant proportions, some having wingspans as wide as 50 feet and weighing as much as 400 pounds.

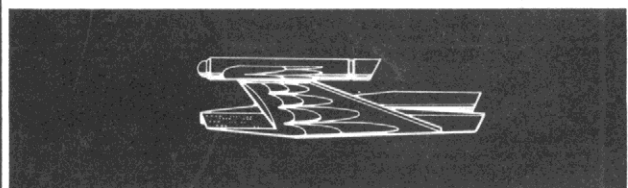



V-9 (Night Flyer) Class VI Cruiser

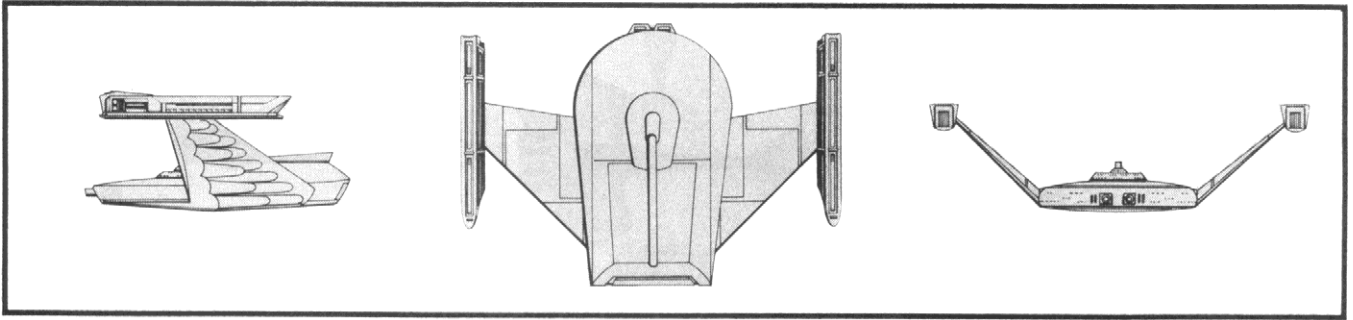

V-9 (Night Flyer) CLASS VI CRUISER

Construction Data:

Model Numbers —	Type 1	Type 6
Date Entering Service —	2/08	2/15
Approx. Number Constructed —	110	70

Hull Data:

Superstructure Points —	15	16
Damage Chart —	B	B
Size		
Length —	136 m	136 m
Width —	190 m	190 m
Height —	57 m	57 m
Weight —	69,400 mt	70,900 mt
Cargo		
Cargo Units —	80 SCU	80 SCU
Cargo Capacity —	4000 mt	4000 mt
Landing Capability —	None	None

Equipment Data:

Control Computer Type —	R4M	R4M
Transporters —		
Standard 9-person	3	3
Emergency 20-person	2	2
Cargo	1	1
Cloaking Device Type —	RCC	RCC
Power Requirement —	15	15

Other Data:

Crew —	162	162
Shuttlecraft —	2	2

Engines And Power Data:

Total Power Units Available —	28	34
Movement Point Ratio —	3/1	3/1
Warp Engine Type —	RWC-1	RWC-2
Number —	2	2
Power Units Available —	12	15
Stress Charts —	M/P	N/Q
Maximum Safe Cruising Speed —	Warp 4	Warp 6
Emergency Speed —	Warp 6	Warp 7
Impulse Engine Type —	RIC-2	RIC-2
Power Units Available —	4	4

Weapons And Firing Data:

Beam Weapon Type —	RB-6	RB-6
Number —	4, in 2 banks of 2	4, in 2 banks of 2
Firing Arcs —	2 p/f/s, 2 aft	2 p/f/s, 2 aft
Firing Chart —	T	T
Maximum Power —	6	6
Damage Modifiers —		
+2	(1 - 18)	(1 - 18)
Plasma Weapon Type —	RPL-1	RPL-1
Number —	2	2
Firing Arcs —	F	F
Firing Chart —	E	E
Power To Arm —	10	10
Damage —	See Chart	See Chart

Shields Data:

Deflector Shield Type —	RSH	RSH
Shield Point Ratio —	1.2	1.2
Maximum Shield Power —	11	11

Combat Efficiency:

D-	63.5	70.4
WDF-	42.4	42.4

Notes:

Known Sphere Of Operation: Federation borders

Data Reliability: C

Major Data Source: Triangle Sector Intelligence

The V-9 Class, created from plans for the older V-8 (Bird Of Prey) Class, was constructed in response to the need for increased firepower and speed. Its similarity to the V-8 on casual inspection is responsible for the prolonged myth that the V-8 was the mainstay of the Romulan Navy.

The Type 1 was introduced about Stardate 2/0805. It was the first vessel in the Romulan fleet to carry two plasma weapons, and it had an impressive array of disruptors and a cloaking device. This vessel reportedly became extremely popular with front line commanders, because of its ability to deliver multiple plasma weapon strikes. It did not, however, address the speed problem still seen in the concurrent Type 4 V-8, and several power plant changes resulted in the successful Type 6.

Of the approximately 180 V-9s constructed, about 160 remain in active service; of these, some are known to be assigned to Romulan Intelligence as training vessels. There are reports of these vessels operating within the Triangle.

The class is named from the Romulan *temar vastaram* (night flyer), in reference to a small, nocturnal, flying predator native to Remus. *The Eridam Papers* state that they were the source of many ancient legends and myths about invisible predators from another dimension.



V-11 (Stormbird) Class VII/X Cruiser

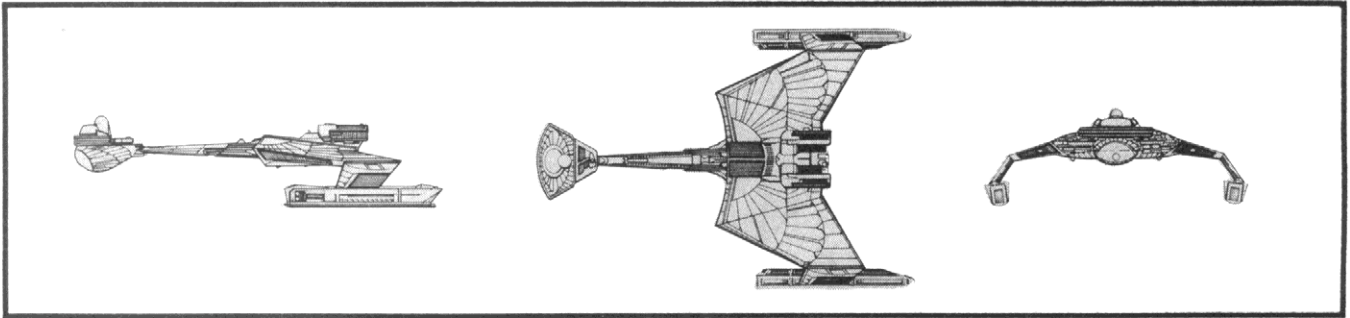

V-11 (Stormbird) CLASS VII/X CRUISER

Construction Data:	Type 1	Type 2	Type 5
Model Numbers —	VII	IX	X
Ship Class —	2/09	2/12	2/17
Date Entering Service —	80	40	50
Approx. Number Constructed —			
Hull Data:			
Superstructure Points —	20	20	21
Damage Chart —	C	C	C
Size			
Length —	216 m	220 m	221 m
Width —	152 m	152 m	156 m
Height —	55 m	55 m	57 m
Weight —	96,600 mt	136,300 mt	141,200 mt
Cargo			
Cargo Units —	120 SCU	120 SCU	120 SCU
Cargo Capacity —	6000 mt	6000 mt	6000 mt
Landing Capability —	None	None	None
Equipment Data:			
Control Computer Type —	R4M	R4M	R5M
Transporters —			
Standard 9-person	3	3	3
Emergency 18-person	1	1	1
Combat 22-person	5	5	5
Cargo	2	2	2
Cloaking Device Type —	RCC	RCC	RCD
Power Requirement —	15	15	22
Other Data:			
Crew —	350	355	350
Troops —	220	220	220
Shuttlecraft —	5	5	5
Engines And Power Data:			
Total Power Units Available —	40	41	44
Movement Point Ratio —	4/1	4/1	4/1
Warp Engine Type —	KWD-1	RWF-1	RWF-1
Number —	2	2	2
Power Units Available —	18	16	18
Stress Charts —	L/N	O/O	G/L
Maximum Safe Cruising Speed —	Warp 6	Warp 7	Warp 7
Emergency Speed —	Warp 8	Warp 9	Warp 9
Impulse Engine Type —	KIC-2	RIC-2	RID-1
Power Units Available —	4	5	8
Weapons And Firing Data:			
Beam Weapon Type —	RB-6	RB-6	RB-10
Number —	4	4	4
Firing Arcs —	2 p.f., 2 f.s.	2 p.f., 2 f.s.	2 p.f., 2 f.s.
Firing Chart —	T	T	U
Maximum Power —	6	6	8
Damage Modifiers —			
+3	—	—	(1 - 8)
+2	(1 - 18)	(1 - 18)	(9 - 16)
+1	—	—	(17 - 20)
Missile Weapon Type —	None	None	RP-3
Number —	—	—	2
Firing Arcs —	—	—	1 fwd, 1 aft
Firing Chart —	—	—	Q
Power To Arm —	—	—	1
Damage —	—	—	10
Plasma Weapon Type —	None	RPL-1	None
Number —	—	1	—
Firing Arcs —	—	fwd	—
Firing Chart —	—	E	—
Power To Arm —	—	10	—
Damage —	—	See Chart	—
Shields Data:			
Deflector Shield Type —	RSG	RSK	RSI
Shield Point Ratio —	1.1	1.2	1.3
Maximum Shield Power —	11	13	11
Combat Efficiency:			
D-	58.6	76.6	93.0
WDF-	30.8	36.6	58.2
	1604.55	7802.56	5412.6

Notes:

Known Sphere Of Operation: Empire-wide use

Data Reliability: A

Major Data Source: Klingon version in Star Fleet possession; Klingon Sector Intelligence

Because of the Romulan-Klingon technological exchange treaties, the Klingons agreed to exchange their D-7A Class cruisers for Romulan plasma weapons and several old-style cloaking devices. These vessels, delivered Stardate 2/09, 2/12, and 2/17 became the V-11 Class.

The 80 vessels in the initial shipment were stripped of their weapons, but the Klingon engines were retained to form the Type 1. The 42 in the second shipment were delivered without engines, shields, or weapons; these were fitted as the Type 2 with a plasma weapon and more efficient shielding. The 50 vessels in the final shipment also were delivered completely stripped, and these were fitted as the Type 5, with fore- and aft-mounted photon torpedoes reminiscent of the Klingon D-7M Class. Types 3 and 4 are modified Type 1s.

Although 172 of these ships have entered Romulan service, they are not liked by their commanders or crews, many of whom consider them to be enemy vessels. In recent years, the Romulans have begun deploying many of the approximately 160 remaining in active service along the Klingon borders in direct violation of the signed accords.

The class is named for the *vas'kalabam* (bird of storms), a small, flying predator of Remus. These nocturnal avians are often seen gliding on the rising winds before a storm and it is said they are capable of travelling hundreds of miles in the vanguard of a storm.



V-20 (Star Seeker) Class VII Cruiser

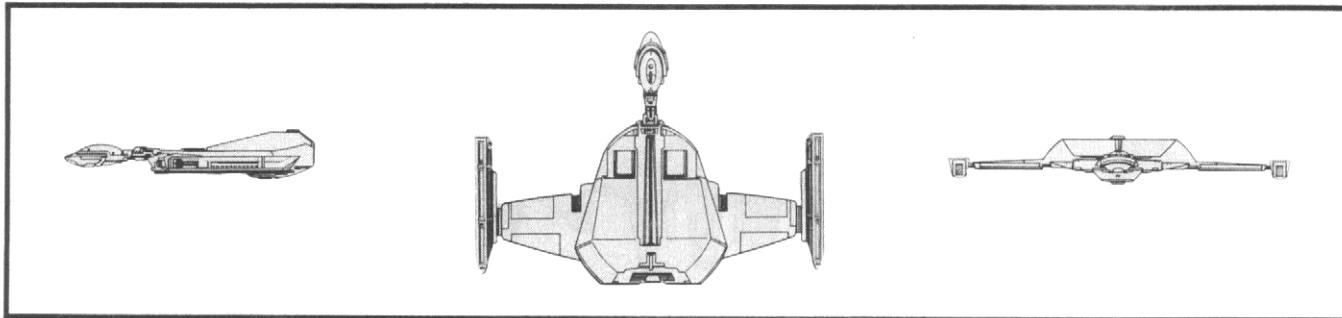

V-20 (Star Seeker) CLASS VII CRUISER

Construction Data:

Model Numbers —	Type 1	Type 2
Date Entering Service —	2/17	2/19
Approx. Number Constructed —	40	25

Hull Data:

Superstructure Points —	16	17
Damage Chart —	C	C
Size		
Length —	110 m	112 m
Width —	161 m	161 m
Height —	21 m	21 m
Weight —	91,500 mt	93,400 mt

Cargo

Cargo Units —	150 SCU	150 SCU
Cargo Capacity —	7500 mt	7500 mt
Landing Capability —	None	None

Equipment Data:

Control Computer Type —	R4M	R4M
Transporters —		
Standard 9-person	2	2
Emergency 20-person	2	2
Cargo	1	1
Cloaking Device Type —	RCC	RCC
Power Requirement —	15	15

Other Data:

Crew —	205	205
Shuttlecraft —	2	2

Engines And Power Data:

Total Power Units Available —	42	42
Movement Point Ratio —	3/1	3/1
Warp Engine Type —	RWD-1	RWD-1
Number —	2	2
Power Units Available —	16	16
Stress Charts —	O/O	O/O
Maximum Safe Cruising Speed —	Warp 6	Warp 6
Emergency Speed —	Warp 7	Warp 7
Impulse Engine Type —	RIE-1	RIE-1
Power Units Available —	10	10

Weapons And Firing Data:

Beam Weapon Type —	RB-10	RB-10
Number —	4, in 2 banks of 2	4, in 2 banks of 2
Firing Arcs —	2 f/p, 2 f/s	2 f/p, 2 f/s
Firing Chart —	U	U
Maximum Power —	8	8
Damage Modifiers —		
+3	(1 - 8)	(1 - 8)
+2	(9 - 16)	(9 - 16)
+1	(17 - 20)	(17 - 20)
Missile Weapon Type —	None	RP-2
Number —	—	3
Firing Arcs —	—	2 fwd, 1 aft
Firing Chart —	—	H
Power To Arm —	—	1
Damage —	—	8
Plasma Weapon Type —	RPL-2	None
Number —	1	—
Firing Arcs —	fwd	—
Firing Chart —	M	—
Power To Arm —	15	—
Damage —	See Chart	—

Shields Data:

Deflector Shield Type —	RSH	RSK
Shield Point Ratio —	1.2	1.2
Maximum Shield Power —	10	14

Combat Efficiency: D-	76.9	84.3
WDF-	58.2	52.4

Notes:

Known Sphere Of Operation: Empire-wide use

Data Reliability: D

Major Data Source: Project Grey Ghost

The V-20 Type 1 was introduced about Stardate 2/18, with the Type 2 brought into service about a year later. The differences between the two are in the missile weapon types and the shields, as well as in the superstructure strength.

The vessel is reputed to be roomy, by Romulan standards. Because the interior of the ship is compartmented for combat, the vessel's survivability is much greater in case of a hull rupture or interior fires.

All of the approximately 70 vessels built are in active service. Reports reveal that ten of both types are being manufactured per year, which recent rapid build-up has alarmed both the Klingons and UFP.

The class is named from the Romulan *galan stelri* (seeker of stars), in reference to its mission in the Exploration Division.

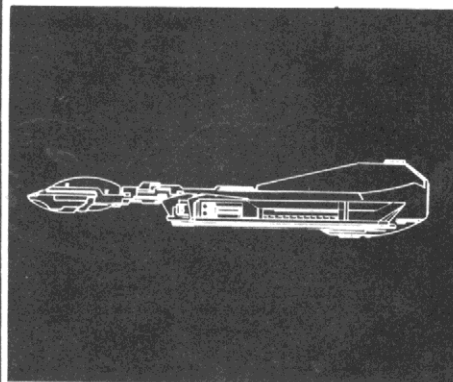



V-27 (Comet Of Destruction) Class XII Cruiser

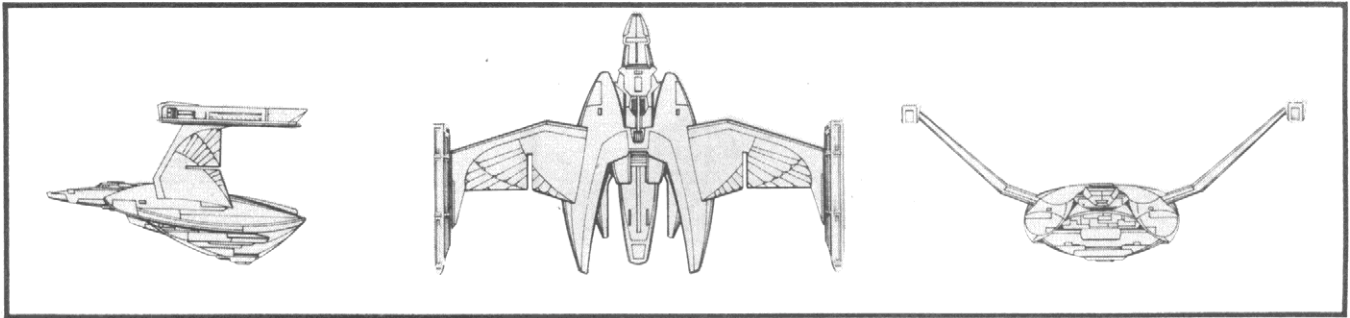

V-27 (Comet Of Destruction) CLASS XII CRUISER

Construction Data:

Model Numbers —	Type 1	Type 2
Date Entering Service —	2/16	2/18
Approx. Number Constructed —	30	20

Hull Data:

Superstructure Points —	25	26
Damage Chart —	C	C
Size		
Length —	190 m	190 m
Width —	305 m	305 m
Height —	120 m	120 m
Weight —	188,700 mt	193,400 mt
Cargo		
Cargo Units —	440 SCU	440 SCU
Cargo Capacity —	22,000 mt	22,000 mt
Landing Capability —	None	None

Equipment Data:

Control Computer Type —	R5M	R6M
Transporters —		
Standard 9-person	4	4
Emergency 20-person	4	4
Cargo	2	2
Cloaking Device Type —	RCE	RCE
Power Requirement —	38	38

Other Data:

Crew —	420	420
Shuttlecraft —	6	6

Engines And Power Data:

Total Power Units Available —	52	52
Movement Point Ratio —	4:1	4:1
Warp Engine Type —	RWG-1	RWG-1
Number —	2	2
Power Units Available —	24	24
Stress Charts —	G/L	G/L
Maximum Safe Cruising Speed —	Warp 7	Warp 7
Emergency Speed —	Warp 9	Warp 9
Impulse Engine Type —	RID-1	RID-1
Power Units Available —	4	4

Weapons And Firing Data:

Beam Weapon Type —	RB-10	RB-11
Number —	4, in 2 banks of 2	4, in 2 banks of 2
Firing Arcs —	2 p.f., 2 f.s	2 p.f., 2 f.s
Firing Chart —	U	V
Maximum Power —	8	9
Damage Modifiers —		
+3	(1 - 8)	(1 - 10)
+2	(8 - 16)	(11 - 16)
+1	(17 - 20)	(17 - 21)
Beam Weapon Type —	RB-6	RB-6
Number —	2, in a bank	2, in a bank
Firing Arcs —	aft	aft
Firing Chart —	T	T
Maximum Power —	6	6
Damage Modifiers — +2	(1 - 18)	(1 - 18)
Missile Weapon Type —	RP-2	RP-3
Number —	2	2
Firing Arcs —	1 fwd, 1 aft	1 fwd, 1 aft
Firing Chart —	H	Q
Power To Arm —	1	1
Damage —	8	10

Shields Data:

Deflector Shield Type —	RSN	RSN
Shield Point Ratio —	1.2	1.2
Maximum Shield Power —	15	15

Combat Efficiency:

D-	93.8	95.2
WDF-	64.2	79.6

Notes:

Known Sphere Of Operation: Empire-wide use

Data Reliability: C

Major Data Source: Combat reports; Romulan Sector Intelligence

The V-27 Class, like the V-30 Class, its counterpart, was designed to provide flagships for the Romulan Navy that would keep parity with new Klingon and Star Fleet vessels. These vessels are very seldom seen operating alone outside a fleet and will always be found with a destroyer escort group accompanying them.

Introduced about Stardate 2/16, the Type 1 is mounted with photon torpedoes both fore and aft and the newest high-powered disruptors. The Comet saw combat early in its career and proved itself to be a formidable opponent. The Type 2, introduced about Stardate 2/18, mounted improved photon weaponry and disruptors.

Of the approximately 50 V-27s built, all are in active service. These ships are being produced at a rate of about ten per year, a number that has alarmed both the Klingons and UFP commands because the balance of power could easily be swayed with the introduction of large numbers of a ship of this power.

The class is named from the Romulan *takara morlatta* (comet of destruction), in reference to a comet that formerly traveled through the Romulan home system on a 40-year cycle. According to *The Eridan Papers*, this comet was seen by early Romulans as a bearer of death and destruction. It was destroyed by the Romulan navy shortly after inter-planetary travel was established.



V-30 (Winged Defender) Class XII Cruiser

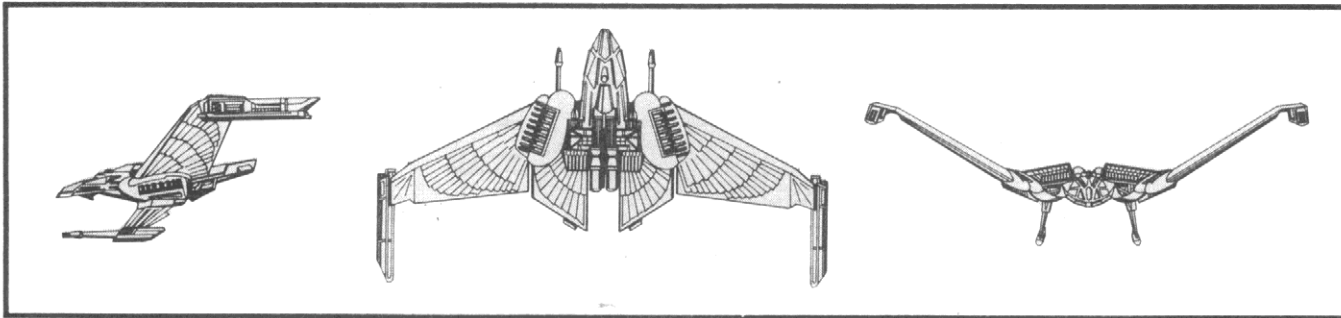

V-30 (Winged Defender) CLASS XII CRUISER

Construction Data:

Model Numbers —	Type 1	Type 2
Date Entering Service —	2/17	2/19
Approx. Number Constructed —	20	15

Hull Data:

Superstructure Points —	30	31
Damage Chart —	C	C
Size		
Length —	187 m	187 m
Width —	293 m	293 m
Height —	94 m	94 m
Weight —	200,100 mt	202,200 mt
Cargo		
Cargo Units —	40 SCU	40 SCU
Cargo Capacity —	2000 mt	2000 mt
Landing Capability —	None	None

Equipment Data:

Control Computer Type —	R6M	R6M
Transporters —		
Standard 9-person	4	4
Emergency 20-person	2	2
Cargo	1	1
Cloaking Device Type —	RCE	RCE
Power Requirement —	38	38

Other Data:

Crew —	350	348
Shuttlecraft —	2	2

Engines And Power Data:

Total Power Units Available —	68	68
Movement Point Ratio —	4/1	4/1
Warp Engine Type —	RWG-1	RWG-1
Number —	2	2
Power Units Available —	24	24
Stress Charts —	G/L	G/L
Maximum Safe Cruising Speed —	Warp 7	Warp 7
Emergency Speed —	Warp 9	Warp 9
Impulse Engine Type —	RIE-3	RIE-3
Power Units Available —	20	20

Weapons And Firing Data:

Beam Weapon Type —	RB-9	RB-9
Number —	8	8
Firing Arcs —	4 fwd, 1 p, 1 s, 1 p a, 1 s a	4 fwd, 1 p, 1 s, 1 p a, 1 s a
Firing Chart —	W	W
Maximum Power —	6	6
Damage Modifiers —		
+3	(1 - 8)	(1 - 8)
+2	(9 - 16)	(9 - 16)
+1	(17 - 20)	(17 - 20)
Missile Weapon Type —	None	RP-3
Number —	—	3
Firing Arcs —	—	2 fwd, 1 aft
Firing Chart —	—	0
Power To Arm —	—	1
Damage —	—	10
Plasma Weapon Type —	RPL-3	None
Number —	1	—
Firing Arcs —	fwd	—
Firing Chart —	T	—
Power To Arm —	8	—
Damage —	See Chart	—

Shields Data:

Deflector Shield Type —	RSL	RSL
Shield Point Ratio —	1.3	1.3
Maximum Shield Power —	13	13

Combat Efficiency:

D-	129.8	131.3
WDF-	98.9	103.3

128.40

135.63

Notes:

Known Sphere Of Operation: Empire-wide use

Data Reliability: A

Major Data Source: Romulan Sector Intelligence; Project Grey Ghost

The V-30 is the most powerful of all Romulan warships. Exemplifying the new-style design, the cruiser looks like a bird and has variable wing positions.

Introduced about Stardate 2/17, the Type 1 mounts eight disruptors arranged to give covering fire in all directions. The newest plasma weapon, the RPL-3, coupled with the cloaking device, allows the V-30 to use standard Romulan tactics and deliver a devastating first strike. The Type 2, introduced about Stardate 2/19, mounts the new RP-3 photon torpedoes both fore and aft.

V-30s are used as flagships or focal points of a fleet, several of which have three or four of these vessels assigned to them. The V-30 is being deployed along the Neutral Zone and areas bordering the Triangle as a deterrent to possible incursions into Empire space. Furthermore, these ships have been used recently for 'shadowing' missions along the Neutral Zone, following a course parallel to and just outside sensors range of any Federation ships that approach the Zone. This has made exact identification of the vessel impossible, and has added to the confusion concerning the exact disposition of these cruisers.

These cruisers, like the V-27s, never operate alone. On every occasion monitored, the V-30 has had an escort of destroyers and/or other cruisers. Although there are no recorded incidents of combat between these ships and Federation vessels, most experts agree that an encounter between a V-30 and an *Enterprise* Class cruiser would be a fairly even match of firepower. Unsubstantiated reports of Klingon encounters with these vessels have been received, with the V-30s reportedly being victorious in all cases.

Of the approximately 35 built, all remain on active duty assigned to border areas. Current intelligence reports show that as many as seven Winged Defenders are being added per year.

The class is named from the Romulan *vas'de-letham* (winged defender), in reference to a small, flying creature native to Remus. These small birds have been known to fight to the death to defend their nest, driving away even full-grown Romulans.



P-2 (Ranajmar) Class II Cutter

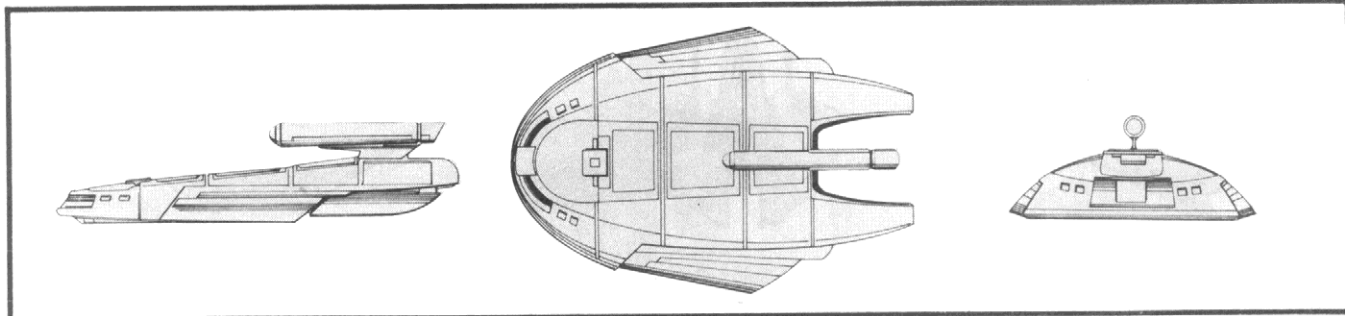

P-2 (Ranajmar) CLASS II CUTTER

Construction Data:		
Model Numbers—	Type 1	Type 4
Date Entering Service—	1/92	2/01
Approx. Number Constructed—	500	950
Hull Data:		
Superstructure Points—	3	4
Damage Chart—	C	C
Size		
Length—	47 m	47 m
Width—	30 m	30 m
Height—	12 m	12 m
Weight—	8,300 mt	15,000 mt
Cargo		
Cargo Units—	10 SCU	10 SCU
Cargo Capacity—	500 mt	500 mt
Landing Capability—	Yes	Yes
Equipment Data:		
Control Computer Type—	R2M	R2M
Other Data:		
Crew—	16	16
Engines And Power Data:		
Total Power Units Available—	8	13
Movement Point Ratio—	1/2	1/1
Warp Engine Type—	RWA-1	RWB-1
Number—	1	1
Power Units Available—	6	10
Stress Charts—	K/M	K/O
Maximum Safe Cruising Speed—	Warp 7	Warp 6
Emergency Speed—	Warp 8	Warp 7
Impulse Engine Type—	RIA-2	RIA-3
Power Units Available—	2	3
Weapons And Firing Data:		
Beam Weapon Type—	RB-2	RB-2a
Number—	2	2
Firing Arcs—	1 f/p/a, 1 f/s/a	1 f/p/a, 1 f/s/a
Firing Chart—	K	K
Maximum Power—	2	3
Damage Modifiers—	none	—
	+3	(1-4)
	+2	(5-9)
	+1	(10-14)
Shields Data:		
Deflector Shield Type—	RSA	RSC
Shield Point Ratio—	1.1	1.2
Maximum Shield Power—	5	10
Combat Efficiency:		
D-	34.3	55.7
WDF-	1.6	4.2

Notes:

Known Sphere Of Operation: Empire-wide use
Data Reliability: B

Major Data Source: Triangle sector intelligence
 Common to the Romulan borders, P-2s also may be found in planetary systems where Romulan law is not fully established. Usually assigned in groups of three to five, these cutters are quite capable of handling civil vessels.

Type 1 is known to have entered service just prior to the outbreak of the Four Years War between the Klingons and the Federation; used to defend newly-acquired areas along the Triangle, it was reported to be underpowered and undergunned to handle its mission. Types 2 and 3 had slight interior and cosmetic changes, but they did not really address the issue of mission suitability and represented no real improvement over the Type 1. The Type 4 remedied this, however, and has not been changed in over 20 years; it has a larger, more powerful warp engine and impulse engine and upgraded weaponry. By Stardate 2/0412, all vessels of this class still in service are thought to have been converted to Type 4.

Of the approximately 1,500 P-2s built, about 950 are in active service, about 50 are assigned to reserve fleets, and about 350 have been lost or destroyed. Best count shows 117 vessels operating in the civil sector; of these, two Type 1s, one Type 2, and two Type 4s operate almost exclusively in the Triangle.

The Eridam Papers indicate that the class derives its name from a small creature of Romulan mythology, a familiar kept by Monan the Seer. The legend says that one day, while Monan was away, bandits attempted to enter his abode and steal his treasures. They were surprised by this strange little reptile, which attacked without care for its safety. Upon his return home, Monan found seven dead bandits and his familiar perilously close to death from the wounds it had received. None of Monan's treasures had been taken.

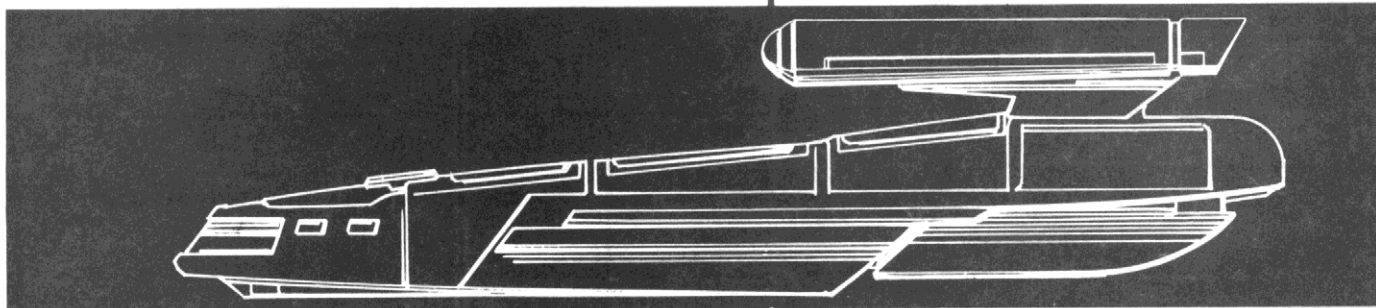



P-3 (Caladan) Class II Cutter

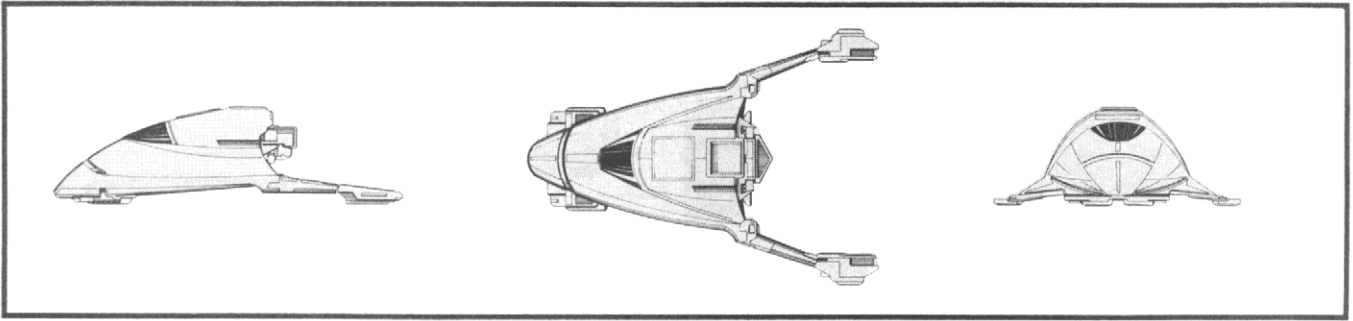

P-3 (Caladan) CLASS II CUTTER

Construction Data:

Model Numbers —	Type 1	Type 3
Date Entering Service —	1/95	2/04
Approx. Number Constructed —	210	745

Hull Data:

Superstructure Points —	2	3
Damage Chart —	B	B
Size		
Length —	45 m	45 m
Width —	32 m	32 m
Height —	12 m	12 m
Weight —	5100 mt	7,050 mt
Cargo		
Cargo Units —	10 SCU	10 SCU
Cargo Capacity —	500 mt	500 mt
Landing Capability —	Yes	Yes

Equipment Data:

Control Computer Type —	R1M	R1M
Transporters —	None	None

Other Data:

Crew —	12	12
Shuttlecraft —	None	None

Engines And Power Data:

Total Power Units Available —	10	10
Movement Point Ratio —	1/2	1/2
Sub-Light Engine Type —	RSLA	RSLA
Number —	1	1
Power Units Available —	10	10
Stress Charts —	H/J	H/J

Weapons And Firing Data:

Beam Weapon Type —	RB-2	RB-2a
Number —	2	2
Firing Arcs —	1 f s, 1 f p	1 f p, 1 f s
Firing Chart —	K	K
Maximum Power —	2	3
Damage Modifiers —	None	(1 - 4)
+3		(5 - 9)
+2		(10 - 14)
+1		

Shields Data:

Deflector Shield Type —	RSA	RSC
Shield Point Ratio —	1.1	1.2
Maximum Shield Power —	5	10

Combat Efficiency:

D-	38.3	39.8
WDF-	1.6	4.2

Built to supplement the *P-2s*, the *P-3s* are used in groups of two or three in the more hostile areas of the Empire. Unlike the *P-2s*, however, the *P-3s* have no warp drive capability, but rely on a powerful impulse engine for their maneuver power. These ships are transferred from one system to another by a special carrier designed to carry up to nine at one time, which can be transported freely.

The Type 1 was found to be under-gunned. This fault was corrected by adding slightly more powerful weapons in the Type 3. By Stardate 2/0612, all Type 1s and Type 2s in service were refitted with the newer weapons.

Of the approximately 960 *P-3s* built, about 650 are in active service, about 50 are in reserve fleets, and about 130 have been lost or destroyed. Intelligence estimates show about 100 Type 1/Type 2s and 30 Type 3s in use in the civil sector; of these, two Type 1s, two Type 2s, and one Type 3 are based in the Triangle.

The class is reportedly named for the Caladan Mountains of Remus, which are reputed to protect the city-states on their leeward sides from the constant and violent winds and also from marauders.

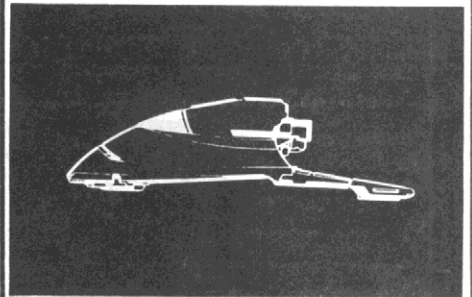
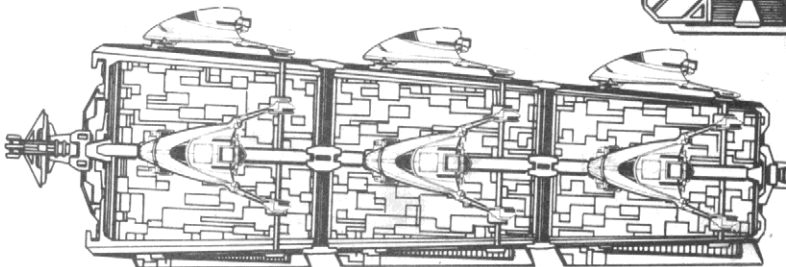
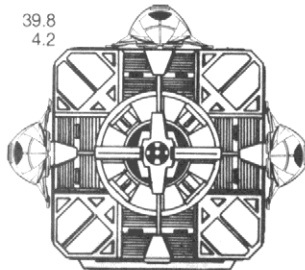



P-12 (Comilius) Class II Cutter

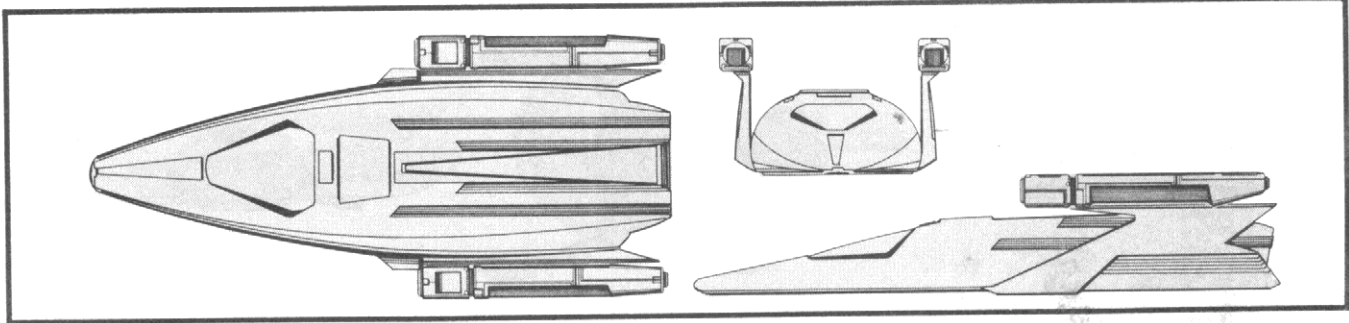

P-12 (Comilius) CLASS II CUTTER

Construction Data:

Model Numbers —	Type 1
Date Entering Service —	2/14
Approx. Number Constructed —	220

Hull Data:

Superstructure Points —	4
Damage Chart —	C
Size	
Length —	54 m
Width —	23 m
Height —	10 m
Weight —	14,800 mt
Cargo	
Cargo Units —	4 SCU
Cargo Capacity —	200 mt
Landing Capability —	Yes

Equipment Data:

Control Computer Type —	R3M
Transporters —	None

Other Data:

Crew —	16
Shuttlecraft —	None

Engines And Power Data:

Total Power Units Available —	20
Movement Point Ratio —	1/1
Warp Engine Type —	RWA-2
Number —	2
Power Units Available —	9
Stress Charts —	J/M
Maximum Safe Cruising Speed —	Warp 6
Emergency Speed —	Warp 7
Impulse Engine Type —	RIA-2
Power Units Available —	2

Weapons And Firing Data:

Beam Weapon Type —	RB-2a
Number —	4, in banks of 2
Firing Arcs —	2 p f s, 2 p a s
Firing Chart —	K
Maximum Power —	3
Damage Modifiers —	
+3	(1 - 4)
+2	(5 - 9)
+1	(10 - 14)

Shields Data:

Deflector Shield Type —	RSC
Shield Point Ratio —	1/2
Maximum Shield Power —	10

Combat Efficiency:

D-	76.7
WDF-	8.4

Notes:

Known Sphere Of Operation: Federation and Triangle borders

Data Reliability: B

Major Data Source: Klingon version in Star Fleet possession; Klingon sector intelligence

These Klingon vessels were traded to the Romulans beginning Stardate 2/1409, largely because of pressure on the Klingons to replace the structurally-weak N-8 (Klingon K-3) vessels. The P-12s also were altered to mount Romulan engines, weapons systems, and shields, but the modifications actually made the ships more structurally sound, probably because of the added support required for the tandem warp engines.

As of this date, only one type is believed to be in service. It obviously has proven effective in its gunboat/systems patrol role, and it is being used along Federation borders and those of the Triangle. Of the 220 acquired in the exchange, about 200 are in active service. Six have been seen in the Triangle operating in the civil sector.

The class is said to have been named for the famous Praetor Comilius, who, after suffering several serious defeats at the hands of his enemies, withdrew to his capital city to hold out for six years against the massive armies that each had assembled. He negotiated an alliance with one of his adversaries and broke the siege, later conquered his remaining enemies, and brought peace to his people that lasted a century.

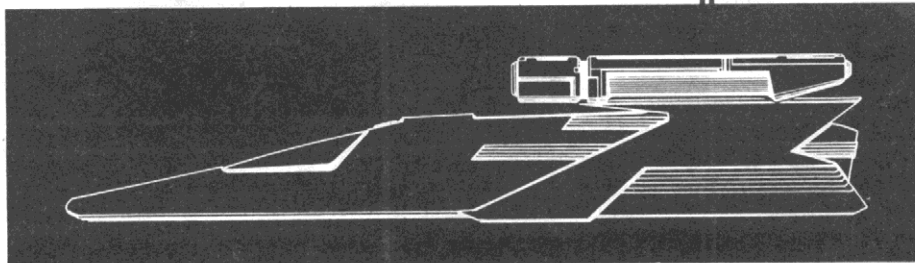

Time Line Of Ac

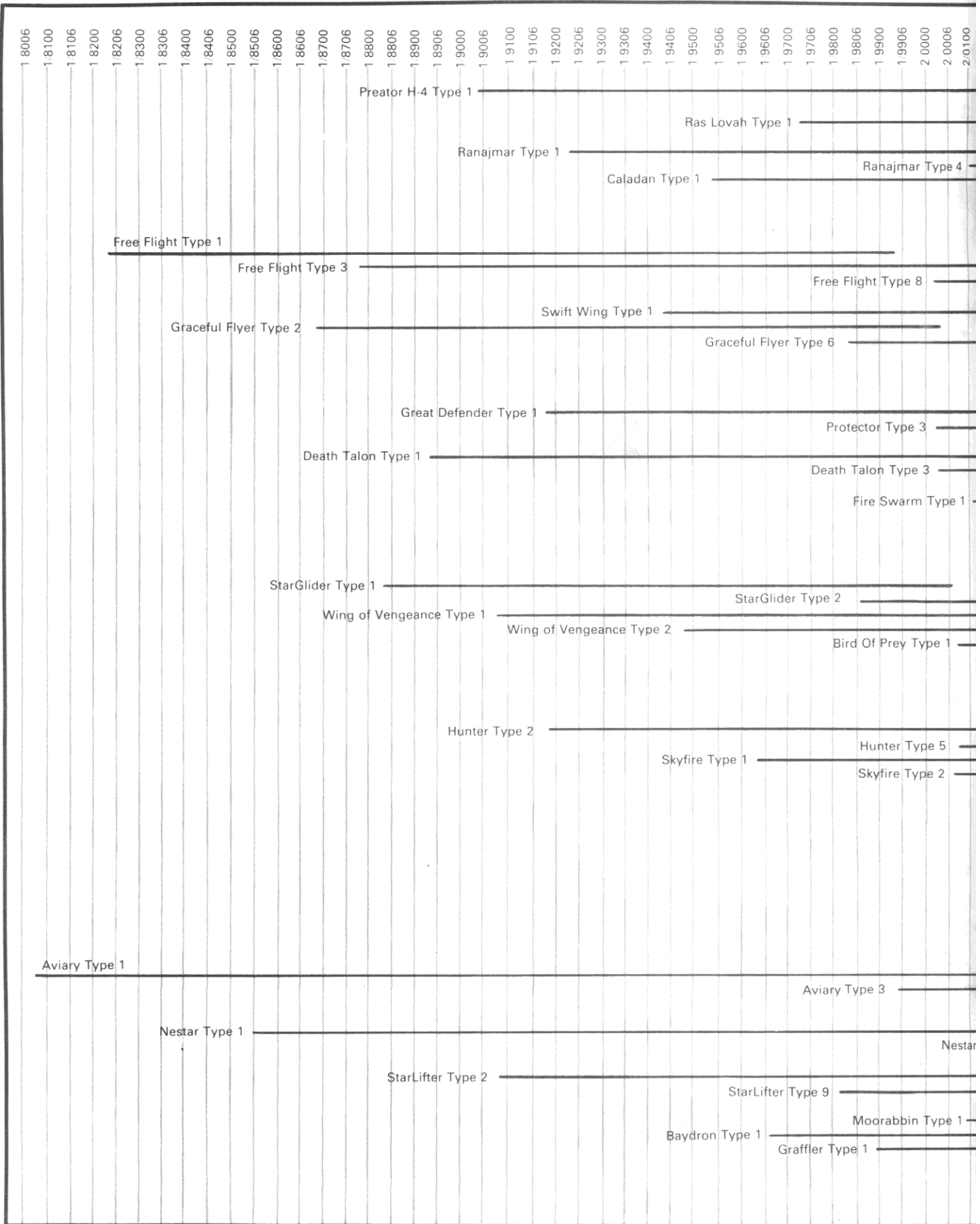

ive Service Duty

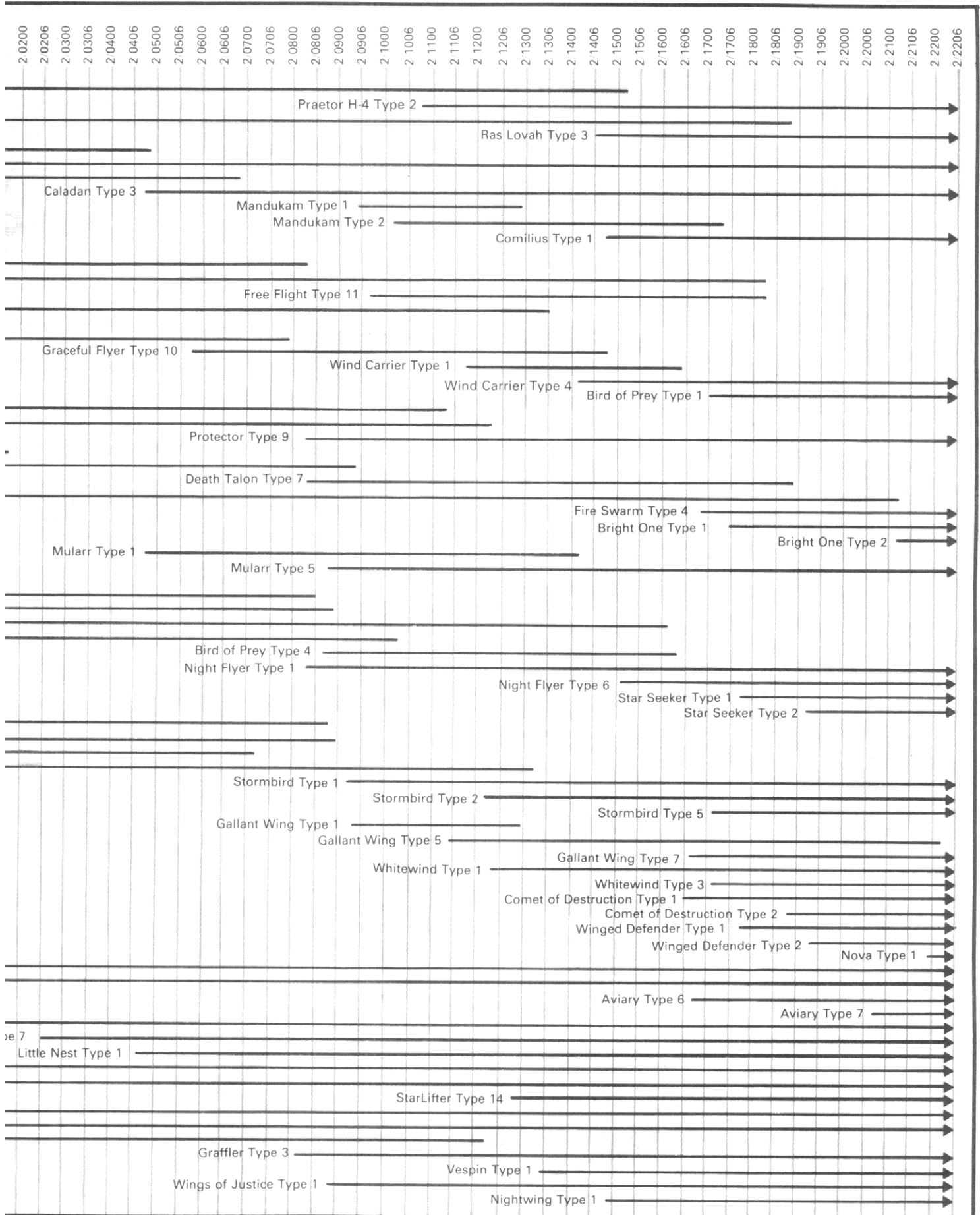

Romulan Recogn

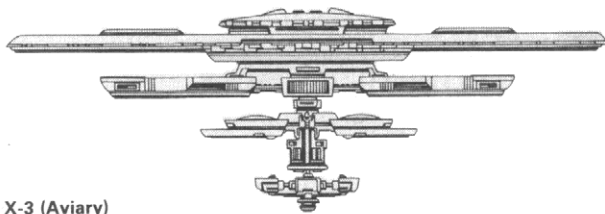

X-3 (Aviary)
BORDER DEFENSE OUTPOST

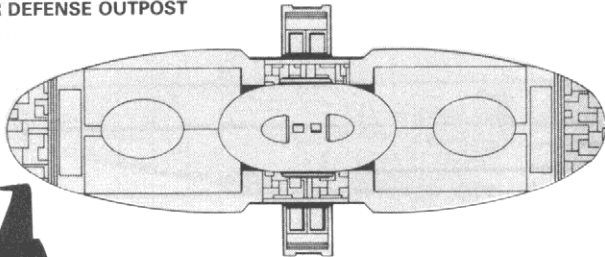

T-10 (Bright One)
CLASS VI DESTROYER



S-11 (Bird Of Prey)
CLASS V SCOUT

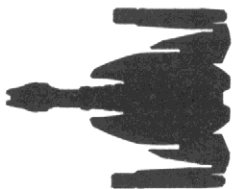

T-5 (Fire Swarm)
CLASS V/VI DESTROYER

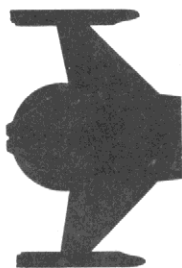

V-9 (Night Flyer)
CLASS VI CRUISER



Q-4 (Protector)
CLASS IV MONITOR



S-9 (Wind Carrier)
CLASS V SCOUT

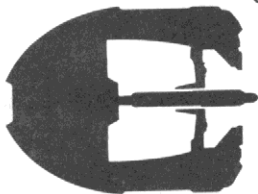

J-8 (Moorabbin)
CLASS IV TRANSPORT



Q-1 (Great Defender)
CLASS III MONITOR

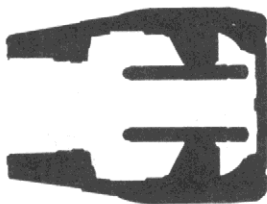

J-4 (Baydron)
CLASS V TRANSPORT

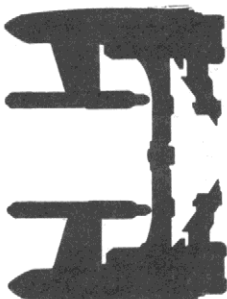

J-3 (Starlifter)
CLASS VI/IX TRANSPORT

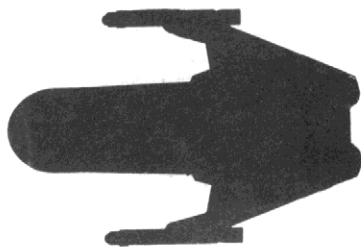

M-4 (Wings Of Justice)
CLASS IX TROOP TRANSPORT

F-2 (Nestar)
CLASS REPAIR FACILITY

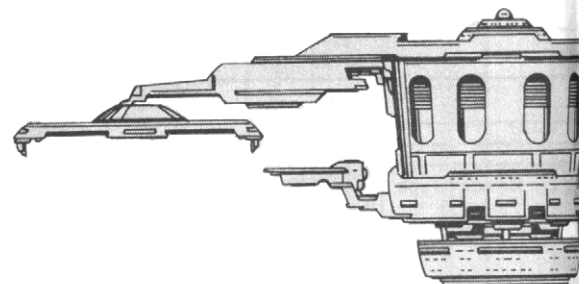

H-4 (Praetor)
CLASS II WARPSHUTTLE

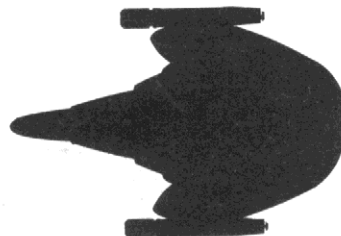

M-8 (Nightwing)
CLASS VIII ASSAULT SHIP



S-3 (Free Flight)
CLASS III/IV SCOUT

N-8 (Mandukam)
CLASS II GUNBOAT

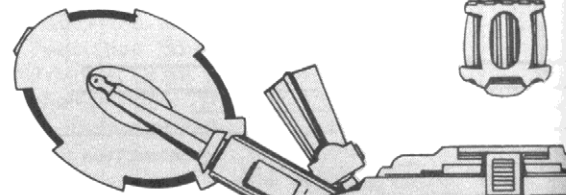

V-8 (Bird Of Prey)
CLASS VI CRUISER



T-2 (Death Talon)
CLASS IV DESTROYER

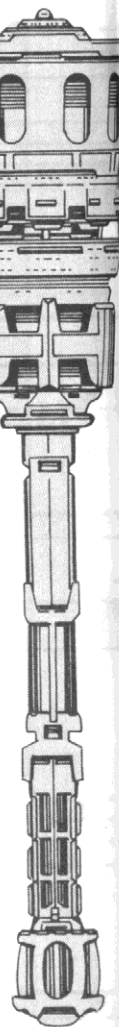

Classification Silhouettes

TY

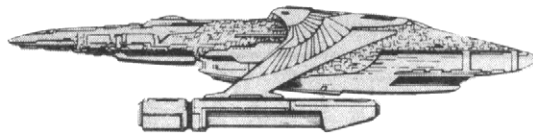

Z-1 (Nova)
CLASS XIII BATTLESHIP

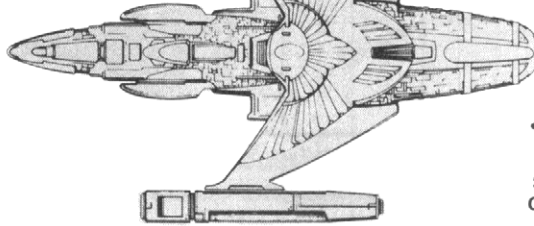

V-7 (Whitewind)
CLASS IX/X CRUISER



S-4 (Swift Wing)
CLASS IV SCOUT

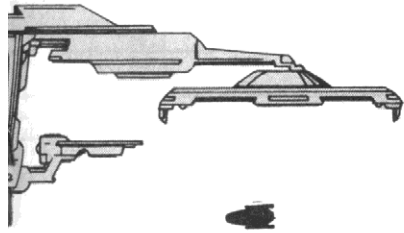

H-5 (Ras Lovah)
CLASS I H-5 WARPSHUTTLE



V-1 (Starglider)
CLASS V CRUISER

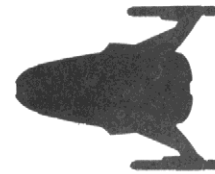

V-2 (Hunter)
CLASS VII CRUISER

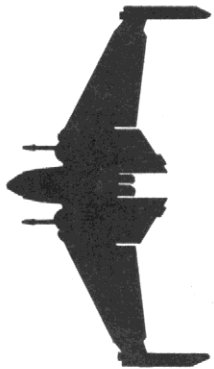

V-30 (Winged Defender)
CLASS XII CRUISER

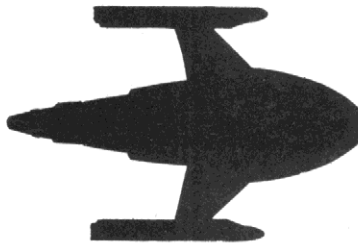

I-7 (Vespin)
CLASS XI FREIGHTER

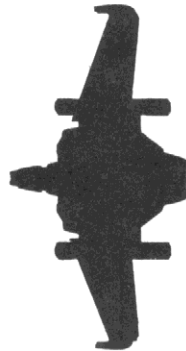

V-6 (Gallant Wing)
CLASS X/XII CRUISER



P-3 (Caladan)
CLASS II CUTTER

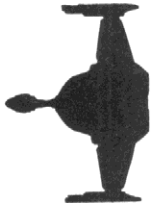

V-20 (Star Seeker)
CLASS VII CRUISER



P-2 (Ranajmar)
CLASS II CUTTER

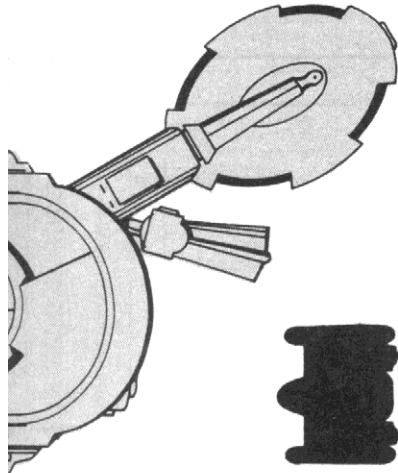

E-5 (Little Nest)
CLASS VII REPAIR TENDER



V-4 (Wing Of Vengeance)
CLASS VI CRUISER

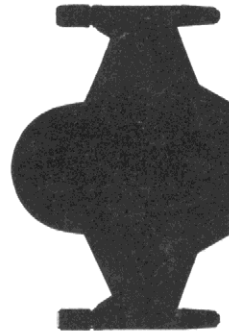

I-4 (Graffler)
CLASS VII/IX FREIGHTER

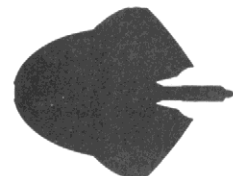

R-4 (Mularr)
CLASS VI ESCORT



CS-2 (Graceful Flyer)
CLASS V COURIER

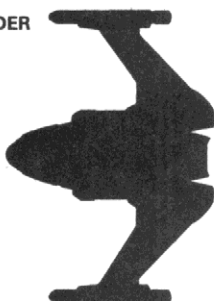

V-5 (Skyfire)
CLASS VII/VIII CRUISER

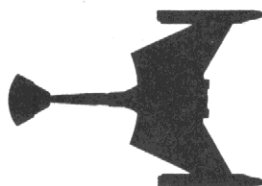

V-11 (Stormbird)
CLASS VII/X CRUISER



V-27 (Comet Of Destruction)
CLASS XII CRUISER



T-2 (Death Talon) Class IV Destroyer

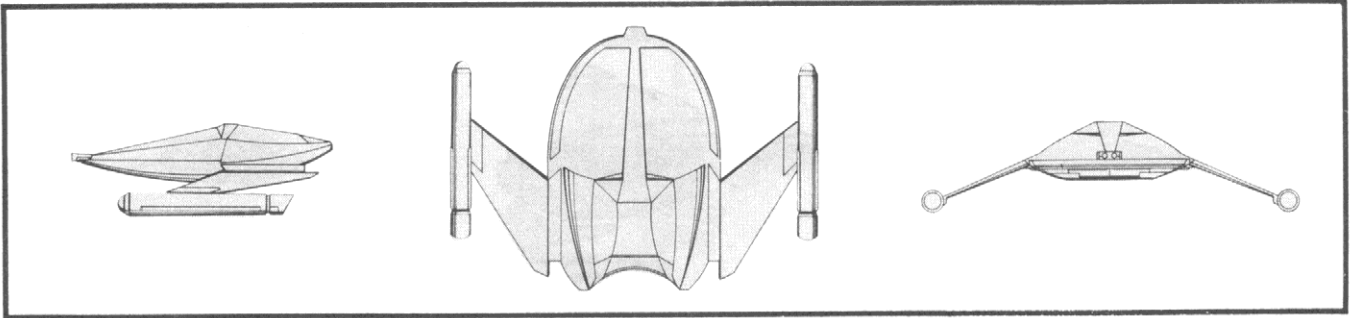

T-2 (Death Talon) CLASS IV DESTROYER

Construction Data:	Type 1	Type 3	Type 7
Model Numbers —	1/89	2/00	2/08
Date Entering Service —			
Approx. Number Constructed —	80	90	70
Hull Data:			
Superstructure Points —	8	8	10
Damage Chart —	B	B	B
Size			
Length —	115 m	120 m	120 m
Width —	165 m	165 m	165 m
Height —	40 m	40 m	40 m
Weight —	31,300 mt	31,500 mt	36,000 mt
Cargo			
Cargo Units —	45 SCU	40 SCU	40 SCU
Cargo Capacity —	2250 mt	2000 mt	2000 mt
Landing Capability —	Yes	Yes	Yes
Equipment Data:			
Control Computer Type —	R3M	R3M	R3M
Transporters —			
Standard 9-person	2	2	2
Emergency 20-person	1	1	1
Cargo	1	1	1
Cloaking Device Type —	None	None	RCB
Power Requirement —	—	—	10
Other Data:			
Crew —	105	110	112
Shuttlecraft —	None	None	None
Engines And Power Data:			
Total Power Units Available —	23	23	25
Movement Point Ratio —	2/1	2/1	2/1
Warp Engine Type —	RWB-1	RWB-1	RWB-1
Number —	2	2	2
Power Units Available —	10	10	10
Stress Charts —	M/P	M/P	M/P
Maximum Safe Cruising Speed —	Warp 6	Warp 6	Warp 6
Emergency Speed —	Warp 7	Warp 7	Warp 7
Impulse Engine Type —	RIB-2	RIB-2	RIB-3
Power Units Available —	3	3	5
Weapons And Firing Data:			
Beam Weapon Type —	RB-2	RB-2	RB-2a
Number —	4	4	6
Firing Arcs —	2 f.p., 2 f.s	2 f.p., 2 f.s	2 f.p., 2 aft, 2 f.s
Firing Chart —	K	K	K
Maximum Power —	2	2	3
Damage Modifiers —	None	None	—
+3	—	—	(1 - 4)
+2	—	—	(5 - 9)
+1	—	—	(10 - 14)
Plasma Weapon Type —	None	RPL-1	RPL-1
Number —	—	1	1
Firing Arcs —	—	fwd	fwd
Firing Chart —	—	E	E
Power To Arm —	—	10	10
Damage —	—	See Chart	See Chart
Shields Data:			
Deflector Shield Type —	RSD	RSC	RSE
Shield Point Ratio —	1.1	1.2	1.2
Maximum Shield Power —	8	7	10
Combat Efficiency:			
D- 38.9		53.4	63.8
WDF- 3.2		7.1	25.0

Notes:

Known Sphere Of Operation: Empire interior

Data Reliability: C

Major Data Source: Border patrol contact reports

Introduced about Stardate 1/8905 and assigned as groups to various fleets in the Romulan navy, the T-2s were designed for escort and patrol duties. Though they had no room to spare for leisure, and though the quarters and work areas were quite cramped, the class is considered to be roomy and comfortable by early standards.

After Stardate 1/9902, vessels appeared in which the hull had been modified to hold a plasma weapon. After Stardate 2/0001, the first Type 3s appeared, with increased length, weight, and crew complement. The firepower of the new type was more than double its original configuration, and the newer shields gave a combat efficiency three times greater than the Type 1. After several years of service, the destroyers began undergoing minor changes to the hull configuration and interior layout, and, beginning with the Type 6, the weapons mountings were increased from four to six.

The Type 7, with this new weapons arrangement, a more powerful impulse engine, and more efficient shields, made its appearance about Stardate 2/0803. A cloaking device also was installed on the Type 7. Reports from the Klingons indicate these were useful in escort duties. Many times, Klingon long-range sensor scans of Romulan convoys would show few escort vessels, but actual contact would reveal five to ten T-2s materializing from nowhere, making the supposed easy Klingon victory and prize a mere dream.

Of the approximately 250 T-2s built, about 150 are in reserve fleets and another 20 are being used as training vessels. Only five of these ships have been sold to the civil sector, all of which operate in the the Triangle or along Federation borders; it is not known if any of these are armed.

The class is named from the Romulan *vas-tagor lattam* (death talon), a reference to the Mogari, a large carnivorous bird native to Romulus. These man-sized birds are reported to swoop down on their prey at speeds up to 120 mph and inflict fatal blows with their long talons.



T-5 (Fire Swarm) Class V/VI Destroyer

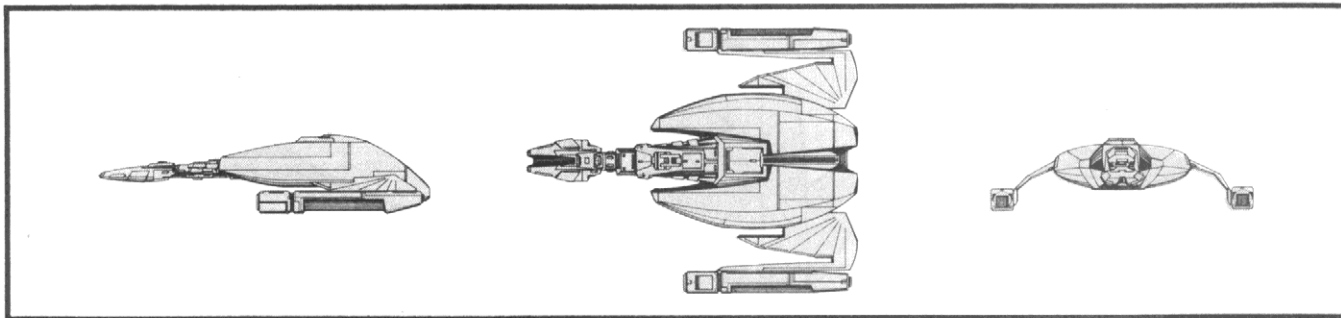

T-5 (Fire Swarm) CLASS V/VI DESTROYER

Construction Data:

Model Numbers —	Type 1	Type 4
Ship Class —	V	VI
Date Entering Service —	2/10	2/15
Approx. Number Constructed —	120	120

Hull Data:

Superstructure Points —	9	10
Damage Chart —	C	C
Size		
Length —	180 m	180 m
Width —	140 m	140 m
Height —	40 m	40 m
Weight —	59,300 mt	68,200 mt
Cargo		
Cargo Units —	40 SCU	40 SCU
Cargo Capacity —	2000 mt	2000 mt
Landing Capability —	None	None

Equipment Data:

Control Computer Type —	R4M	R4M
Transporters —		
Standard 9-person	2	2
Emergency 20-person	2	2
Cargo	1	1
Cloaking Device Type —	RCB	RCC
Power Requirement —	10	15

Other Data:

Crew —	118	118
Shuttlecraft —	1	1

Engines And Power Data:

Total Power Units Available —	35	35
Movement Point Ratio —	2/1	3/1
Warp Engine Type —	RWC-2	RWC-2
Number —	2	2
Power Units Available —	15	15
Stress Charts —	N/Q	N/Q
Maximum Safe Cruising Speed —	Warp 6	Warp 6
Emergency Speed —	Warp 8	Warp 7
Impulse Engine Type —	RIB-3	RIB-3
Power Units Available —	5	5

Weapons And Firing Data:

Beam Weapon Type —	RB-8	RB-8
Number —	8, in 4 banks of 2	8, in 4 banks of 2
Firing Arcs —	2 p, 2 f, 2 s, 2 a	2 p, 2 f, 2 s, 2 a
Firing Chart —	N	N
Maximum Power —	6	6
Damage Modifiers —		
+3	(1 - 4)	(1 - 4)
+2	(5 - 9)	(5 - 9)
+1	(10 - 13)	(10 - 13)
Missile Weapon Type —	None	RP-2
Number —	—	1
Firing Arcs —	—	f
Firing Chart —	—	H
Power To Arm —	—	1
Damage —	—	8

Shields Data:

Deflector Shield Type —	RSC	RSE
Shield Point Ratio —	1/2	1/2
Maximum Shield Power —	6	8

Combat Efficiency:

D-	64.3	62.6
WDF-	37.2	49.6

Notes:

Known Sphere Of Operation: Klingon border

Data Reliability: D (upgrade)

Major Data Source: Klingon sector intelligence; Project Grey Ghost encounters

After Stardate 2/1001, the T-5 Class of high-fire-power destroyers appears to have become the mainstay of the Romulan navy on the Klingon border. The Type 1 was a replacement for the T-2 (Death Talon) destroyer, with a more powerful engine and more powerful disruptors, thus giving it a greater combat efficiency than its counterpart. After some small variations on the overall design, the Type 4 was introduced and immediately saw success as a combat vessel. This model was heavier than the earlier models, causing it to be slightly slower at warp speeds and not quite as maneuverable; however, this was offset by the increase in firepower. The addition of two more disruptors and a photon torpedo made this destroyer a ship not to be taken lightly.

Intercepted subspace radio transmissions show that, on Stardate 2/1911, a convoy escorted by three T-5s was attacked by six Klingon D-18B destroyers. With great skill, the Romulans maneuvered their ships and destroyed the Klingon group one by one, until only one enemy vessel remained. This Klingon was heavily damaged and was not able to flee or destruct and was captured after a spirited boarding action. The Romulan losses in this incident were one T-5 damaged beyond repair and abandoned (likely destroyed), one damaged but still under its own power, and the flagship undamaged.

Of the approximately 240 T-5s built, more than 180 remain in active service. At this time, it is estimated that 15 of these ships are being produced per year. About 20 have been placed in reserve fleets, and none is known to be in the civil sector.

The class is named from the Romulan *ocala sindari* (fire swarm), in reference to an insectoid found on the planet Korma'ahve. About the size of a Terran gnat, these creatures travel in swarms of thousands. Although they are not aggressive in nature, physical contact with them is extremely painful. As a by-product of their nervous system, they secrete an acid that burns the skin on contact.

23.91 21.04



T-10 (Bright One) Class VI Destroyer

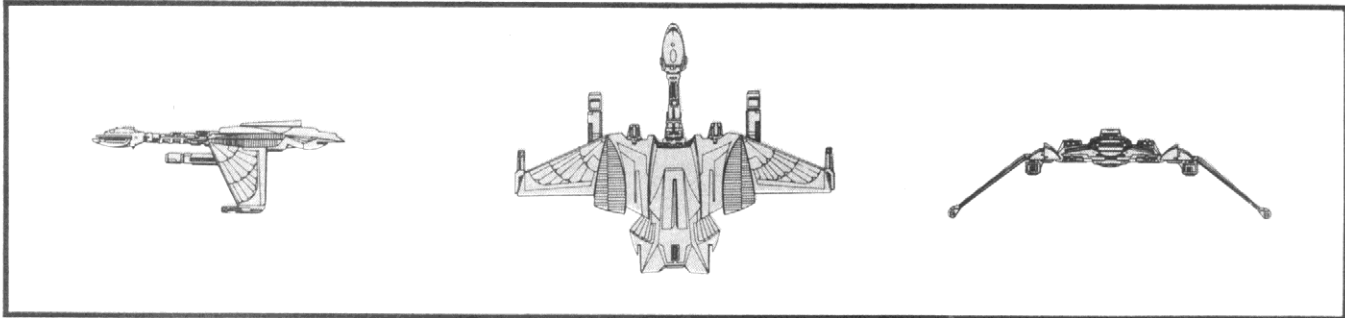

T-10 (Bright One) CLASS VI DESTROYER

Construction Data:

Model Numbers —	Type 1	Type 2
Date Entering Service —	2/16	2/21
Approx. Number Constructed —	90	20

Hull Data:

Superstructure Points —	10	11
Damage Chart —	B	B
Size		
Length —	140 m	140 m
Width —	180 m	180 m
Height —	52 m	52 m
Weight —	61,300 mt	63,400 mt
Cargo		
Cargo Units —	85 SCU	85 SCU
Cargo Capacity —	4250 mt	4250 mt
Landing Capability —	None	None

Equipment Data:

Control Computer Type —	R4M	R4M
Transporters —		
Standard 9-person	2	2
Emergency 20-person	1	1
Cargo	1	1
Cloaking Device Type —	RCC	RCC
Power Requirement —	15	15

Other Data:

Crew —	122	122
Shuttlecraft —	1	1

Engines And Power Data:

Total Power Units Available —	34	40
Movement Point Ratio —	3/1	3/1
Warp Engine Type —	RWC-2	RWC-2
Number —	2	2
Power Units Available —	15	15
Stress Charts —	N/Q	N/Q
Maximum Safe Cruising Speed —	Warp 6	Warp 6
Emergency Speed —	Warp 7	Warp 7
Impulse Engine Type —	RIC-2	RIE-1
Power Units Available —	4	10

Weapons And Firing Data:

Beam Weapon Type —	RB-8	RB-8
Number —	4	4
Firing Arcs —	2 f.p., 2 f.s.	2 f.p., 2 f.s.
Firing Chart —	N	N
Maximum Power —	6	6
Damage Modifiers —		
+3	(1 - 4)	(1 - 4)
+2	(5 - 9)	(5 - 9)
+1	(10 - 13)	(10 - 13)
Missile Weapon Type —	None	RP-3
Number —	—	1
Firing Arcs —	—	fwd
Firing Chart —	—	Q
Power To Arm —	—	1
Damage —	—	10

Shields Data:

Deflector Shield Type —	RSE	RSE
Shield Point Ratio —	1.2	1.2
Maximum Shield Power —	8	8

Combat Efficiency:

D-	56.3	57.7
WDF-	24.8	33.1

14 19 09

Notes:

Known Sphere Of Operation: Border

Data Reliability: C

Major Data Source: Border patrol contact reports

The *T-10s* were designed to replace the older *T-2* (Death Talon) models in patrol missions, and, therefore, several of the shortcomings of the older ships were eliminated. Reportedly, the most notable was the size and arrangement of the crew quarters, though Class B plans show the vessels to be small and cramped compared to similar Federation vessels. The Type 2 vessels of recent years mount a larger impulse engine and house a photon torpedo. Nearly all of the approximately 110 *T-10s* remain in active service.

Named for the *reemea*, a brightly-colored bird native to Corill, these destroyers are painted by their crews in striking rainbow colors. Because no two of these vessels look alike, the paint scheme may be used for positive recognition; the scheme for seven of these vessels is recorded in Star Fleet computers.

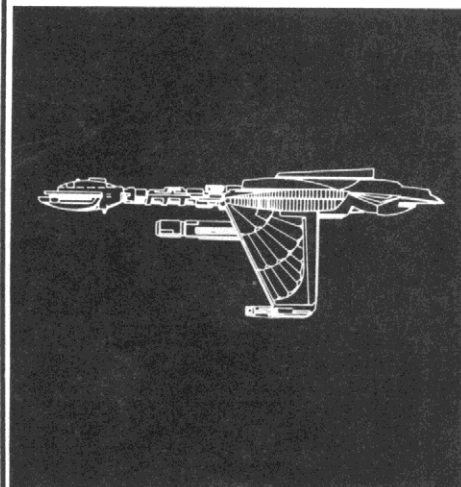



R-4 (Mularr) Class VI Escort

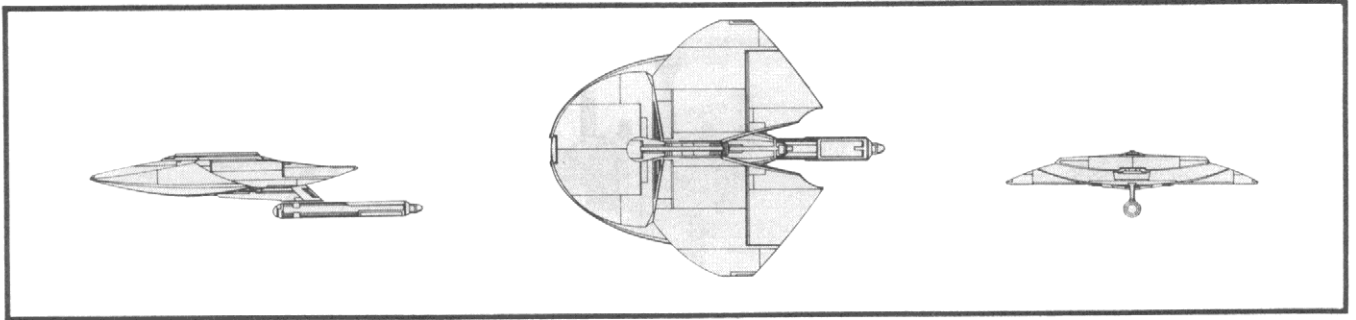

R-4 (Mularr) CLASS VI ESCORT

Construction Data:

Model Numbers —	Type 1	Type 5
Date Entering Service —	2/04	2/08
Approx. Number Constructed —	85	170

Hull Data:

Superstructure Points —	8	8
Damage Chart —	C	C
Size		
Length —	186 m	186 m
Width —	147 m	147 m
Height —	38 m	38 m
Weight —	69,500 mt	71,900 mt

Cargo

Cargo Units —	100 SCU	100 SCU
Cargo Capacity —	5000 mt	5000 mt
Landing Capability —	None	None

Equipment Data:

Control Computer Type —	R3M	R3M
Transporters —		
Standard 9-person	2	2
Emergency 20-person	1	1

Other Data:

Crew —	120	122
Shuttlecraft —	2	2

Engines And Power Data:

Total Power Units Available —	26	28
Movement Point Ratio —	3/1	3/1
Warp Engine Type —	RWF-1	RWF-2
Number —	1	1
Power Units Available —	16	18
Stress Charts —	F/K	F/L
Maximum Safe Cruising Speed —	Warp 7	Warp 7
Emergency Speed —	Warp 9	Warp 8
Impulse Engine Type —	RIE-1	RIE-1
Power Units Available —	10	10

Weapons And Firing Data:

Beam Weapon Type —	RB-3a	RB-8
Number —	4	4
Firing Arcs —	1 p/a, 2 fwd, 1 s/a	1 p/a, 2 fwd, 1 s/a
Firing Chart —	L	N
Maximum Power —	6	6
Damage Modifiers —		
+3	(1 - 3)	(1 - 4)
+2	(4 - 8)	(5 - 9)
+1	(9 - 12)	(10 - 13)

Shields Data:

Deflector Shield Type —	RSC	RSE
Shield Point Ratio —	1.2	1.2
Maximum Shield Power —	5	8

Combat Efficiency:

D-	43.9	53.2
WDF-	14.8	16.4

Notes:

Known Sphere Of Operation: Triangle and Klingon borders

Data Reliability: C (upgrade)

Major Data Source: Project Grey Ghost encounters

Designed strictly as escort vessels and used only for convoy or fleet support, *R-4s* are very rarely seen alone, according to Project Grey Ghost information. Normally assigned in groups of five to seven, they are known to be sufficient in firepower to deter most enemies.

Though several Type 1 vessels remain on active duty, most have been refitted to the Type 5, with improved weapons, more powerful engine, and more efficient shields.

Of the approximately 250 *R-4s* built, about 200 remain in active service and about 20 are in reserve fleets. About Stardate 2/1307, an *R-4* escorting a group of three freighters was taken by a mutinous crew and disappeared with the freighters into the Triangle, where it operates currently. Intelligence reports state that the Romulan government has put a bounty on the crew members' capture and/or elimination.

The class is named for the *mularr*, a large, flying reptile native to Corill. The creature's protective nature provides the vessel its name.

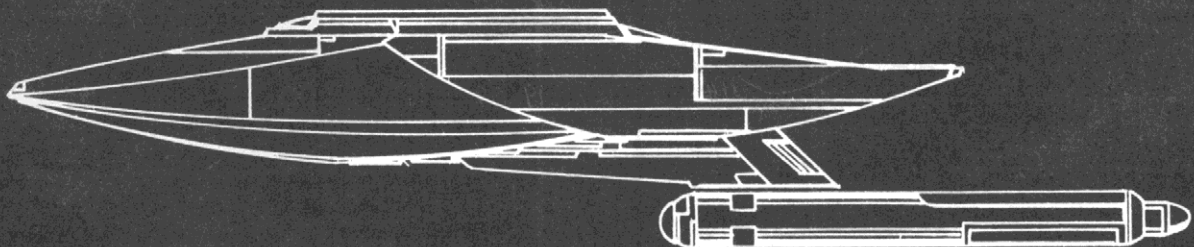



N-8 (Mandukam) Class II Gunboat

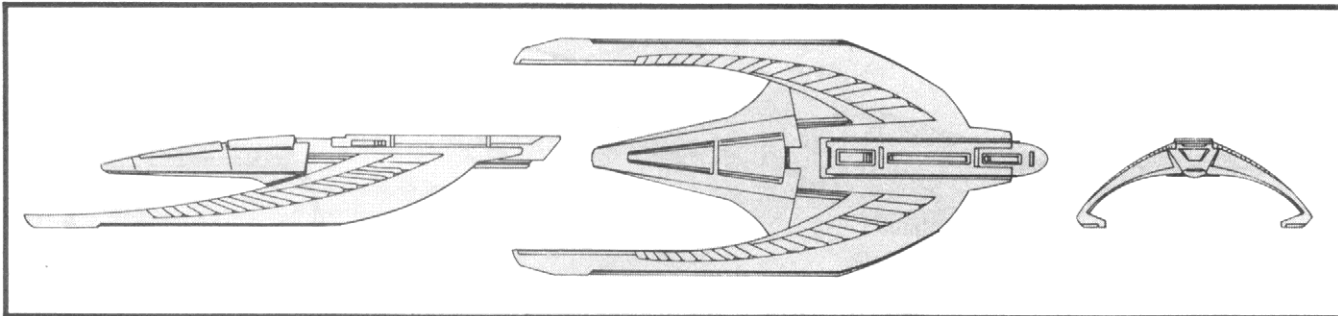

N-8 (Mandukam) CLASS II GUNBOAT

Construction Data:

Model Numbers —	Type 1	Type 2
Date Entering Service —	2/09	2/10
Approx. Number Constructed —	83	40

Hull Data:

Superstructure Points —	3	4
Damage Chart —	C	C
Size		
Length —	53 m	53 m
Width —	23 m	23 m
Height —	9 m	9 m
Weight —	8650 mt	10,970 mt
Cargo		
Cargo Units —	10 SCU	10 SCU
Cargo Capacity —	500 mt	500 mt
Landing Capability —	Yes	Yes

Equipment Data:

Control Computer Type —	R1M	R2M
Transporters —	None	None

Other Data:

Crew —	14	14
Shuttlecraft —	None	None

Engines And Power Data:

Total Power Units Available —	8	11
Movement Point Ratio —	1/2	1/1
Warp Engine Type —	RWA-1	RWA-2
Number —	1	1
Power Units Available —	6	8
Stress Charts —	K/M	K/O
Maximum Safe Cruising Speed —	Warp 7	Warp 6
Emergency Speed —	Warp 8	Warp 7
Impulse Engine Type —	RIA-2	RIA-3
Power Units Available —	2	3

Weapons And Firing Data:

Beam Weapon Type —	RB-2a	RB-2a
Number —	2	3, with 1 bank of 2
Firing Arcs —	1 p.f.s., 1 p.a.s.	2 p.f.s., 1 p.a.s.
Firing Chart —	K	K
Maximum Power —	3	3
Damage Modifiers —		
+3	(1 - 4)	(1 - 4)
+2	(5 - 9)	(5 - 9)
+1	(10 - 14)	(10 - 14)

Shields Data:

Deflector Shield Type —	RSC	RSC
Shield Point Ratio —	1.2	1.2
Maximum Shield Power —	10	10

Combat Efficiency:

D-	64.3	50.7
WDF-	4.2	6.3

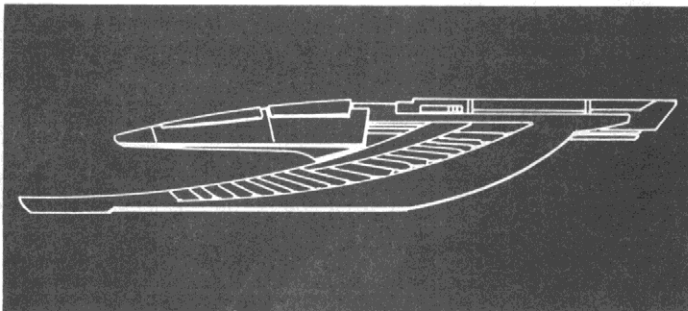

Notes:

Known Sphere Of Operation: Empire spinward borders

Data Reliability: B

Major Data Source: Klingon version of vessel in Star Fleet possession; Klingon sector intelligence

The N-8 Class gunboat is one of the first ships the Romulans acquired (Stardate 2/0905) from the Klingons along the Federation and spinward borders. Though intelligence reports that the Klingons required this disposition as part of the trade agreement, agents reported that, in response to pressure along the Romulan-Klingon border, these ships began to see service in there as well.

Reports from agents within the Klingon Empire show that the Klingon K-3s traded were not fully operational, the Romulans having requested that no engines, weapons, or shields be mounted. Comparison of the Romulan-refitted model with that which the Klingons delivered show that several major structural changes were required in order for the Romulan equipment to be installed. Of these changes, the most notable was the reduction of internal structural components that lessened the superstructure strength, which likely accounts for the vessel's tendency to break apart during high speed maneuvers. The vessel reportedly was not popular with crews. It was removed from service by Stardate 2/1703.

Soon after the Type 1 was put into service, it was found to have inadequate weapons mountings and to be underpowered. The Type 2, brought into service Stardate 2/10, corrected these problems, and, by Stardate 2/13, all Type 1s had been refitted with the newer engines and an additional bank of beam weapons. In making these changes, the superstructure strength was increased somewhat, but not enough to correct the the problems with structural integrity during high-speed maneuvers.

Of the 123 K-3 gumboats exchanged, about 30 N-8s are known to be in reserve fleets. Of the remainder, approximately 10 Type 1s and 35 Type 2s are at work in the civil sector; two Type 1s and six Type 2s operate exclusively in the Triangle.

The class is named in reference to its mission, from the Romulan *mandukam* (vigilant one).



Q-1 (Great Defender) Class III Monitor

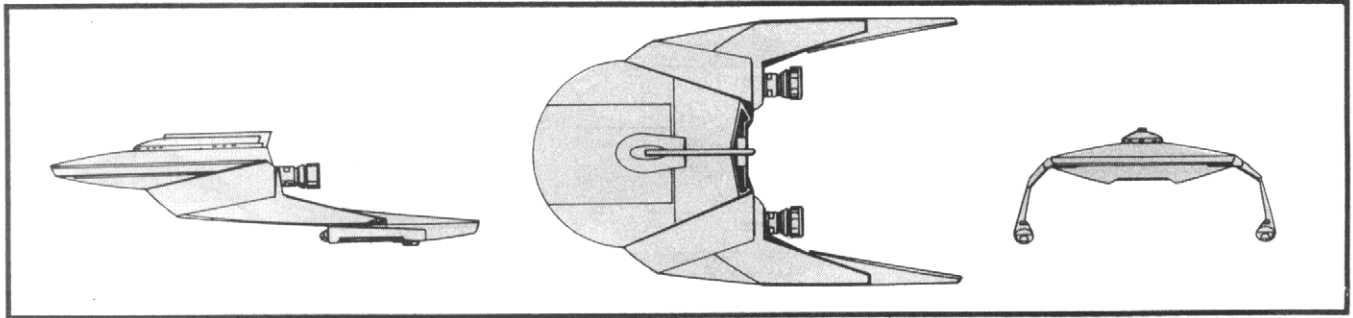

Q-1 (Great Defender) CLASS III MONITOR

Construction Data:

Model Numbers —	Type 1
Date Entering Service —	1/91
Approx. Number Constructed —	150

Hull Data:

Superstructure Points —	6
Damage Chart —	B
Size	
Length —	130 m
Width —	80 m
Height —	35 m
Weight —	15,300 mt
Cargo	
Cargo Units —	20 SCU
Cargo Capacity —	1000 mt
Landing Capability —	None

Equipment Data:

Control Computer Type —	R2M
Transporters —	
Standard 9-person	2

Other Data:

Crew —	32
Shuttlecraft —	1

Engines And Power Data:

Total Power Units Available —	18
Movement Point Ratio —	2/1
Warp Engine Type —	RSLA
Number —	2
Power Units Available —	9

Weapons And Firing Data:

Beam Weapon Type —	RB-2
Number —	8, in 4 banks of 2
Firing Arcs —	2 p.a., 4 fwd, 2 s.a
Firing Chart —	K
Maximum Power —	2
Damage Modifiers —	None

Shields Data:

Deflector Shield Type —	RSD
Shield Point Ratio —	1/1
Maximum Shield Power —	9

Combat Efficiency: D-	34.6
WDF-	6.4

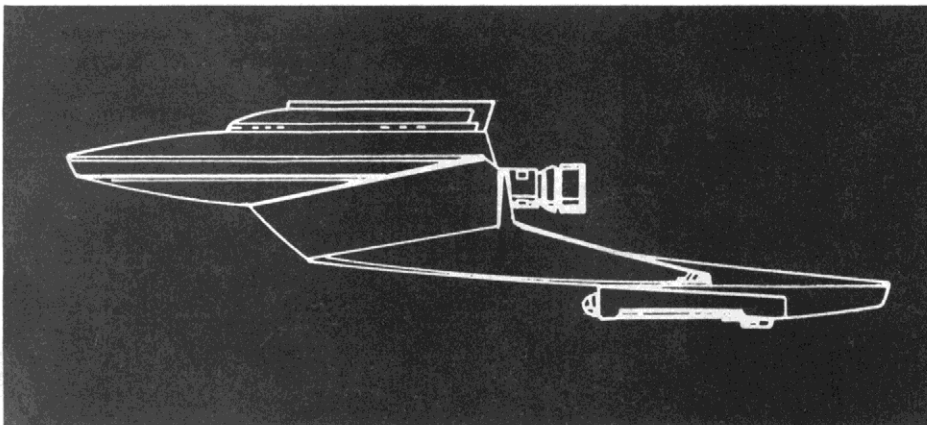

Notes:

Known Sphere Of Operation: Triangle and Klingon borders; Empire interior

Data Reliability: E

Major Data Source: Subspace radio communications monitored by Triangle sector intelligence

About Stardate 1/9109, just prior to the outbreak of the Four Years War, the first of these monitors began active service guarding systems bordering the Triangle area and Klingon territories to coreward. As the war progressed, their numbers were increased, likely because the Romulans feared a possible invasion by either of their foes.

This class is powered by the Romulan Sub-Light Engine Class A and carries no impulse drive system. These vessels mount eight disruptors in four banks, making them formidable opponents for rebels and pirates. It was during the period immediately following the war that the Romulans discovered that the vessels were not quite suited for their mission of support for cutters and gunboats in systems defense. As with most Romulan ships, these vessels were not very comfortable and did not lend themselves to prolonged duty. Because of this, they were reassigned to guard border outposts as the Q-4 (Protector) vessels replaced them; by Stardate 2/1103, all of the vessels of this type are believed to have been removed from active service.

Of the approximately 150 Q-1s built, about 130 have been assigned to active reserve fleets within the interior of the Empire. Twelve are known to have been disarmed and sold to the civil sector. Of the three that operate exclusively in the Triangle, one is rumored to have been fully rearmed for guard duty around Fountainworld, a wealthy tourist spa in the Association Of Outer Free Worlds.

The class is named from the Romulan *d'deletham* (great defender), in reference to its mission.



Q-4 (Protector) Class IV Monitor

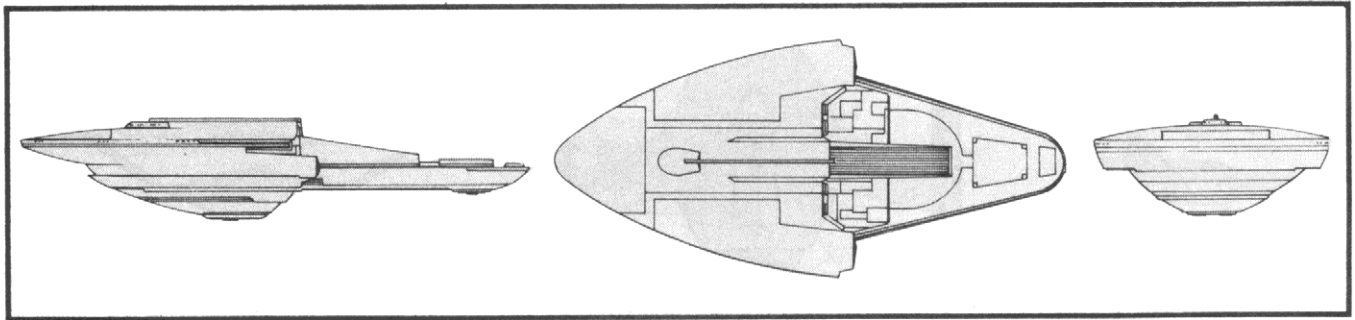

Q-4 (Protector) CLASS IV MONITOR

Construction Data:

Model Numbers —	Type 3	Type 9
Date Entering Service —	2/00	2/08
Approx. Number Constructed —	160	280

Hull Data:

Superstructure Points —	5	6
Damage Chart —	B	B
Size		
Length —	152 m	152 m
Width —	70 m	70 m
Height —	32 m	32 m
Weight —	25,000 mt	29,000 mt
Cargo		
Cargo Units —	12 SCU	12 SCU
Cargo Capacity —	600 mt	600 mt
Landing Capability —	None	None

Equipment Data:

Control Computer Type —	R3M	R4M
Transporters —		
Standard 9-person	1	1
Cloaking Device Type —	RCB	RCB
Power Requirement —	10	10

Other Data:

Crew —	34	34
Shuttlecraft —	1	1

Engines And Power Data:

Total Power Units Available —	27	27
Movement Point Ratio —	3/1	3/1
Sub-Light Engine Type —	RSLA	RSLA
Number —	3	3
Power Units Available —	9	9

Weapons And Firing Data:

Beam Weapon Type —	RB-2a	RB-7a
Number —	10, in 5 banks of 2	10, in 5 banks of 2
Firing Arcs —	4 p/a, 2 fwd, 4 s/a	4 p/a, 2 fwd, 4 s/a
Firing Chart —	K	M
Maximum Power —	3	4
Damage Modifiers —		
+3	(1 - 4)	(1 - 3)
+2	(5 - 9)	(4 - 9)
+1	(10 - 14)	(10 - 14)

Shields Data:

Deflector Shield Type —	RSC	RSC
Shield Point Ratio —	1/2	1/2
Maximum Shield Power —	7	7

Combat Efficiency:

D-	48.9	48.9
WDF-	21.0	30.0

Notes:

Known Sphere Of Operation: Klingon border

Data Reliability: C (upgrade)

Major Data Source: Border patrol contact reports; Project Grey Ghost short-range scans

Probably built to replace the Q-1 (Great Defender), the vessels of the Q-4 Class are more suited for prolonged duty. Vessels near the border are equipped with Sub-Light Class A engines. When these ships first appeared on the frontiers, it was believed that the Romulans had found a way to balance a triary warp envelope. As can be seen, the ships look peculiar with their three engine nacelles, which are easily identified on sensor scan. Project Grey Ghost was unable to confirm that these vessels had warp capability, as originally reported.

The Q-4 class, like its predecessor, is wellarmed. Mounting ten disruptors in five banks, it has a very effective field of fire. The only improvement to the ship weaponry has been with the Type 9, which carries an improved version of the RB-7, known as the RB-7a. By Stardate 2/1204, all Type 3s scanned had been refitted with the RB-7a and given the uprated R4M computer system to handle the added firepower.

Of the approximately 450 Q-4s built, almost 370 remain in active service and about 40 have been assigned to active reserve groups within the Empire.

The class is named from the Romulan *deletham* (protector), in reference to its mission.

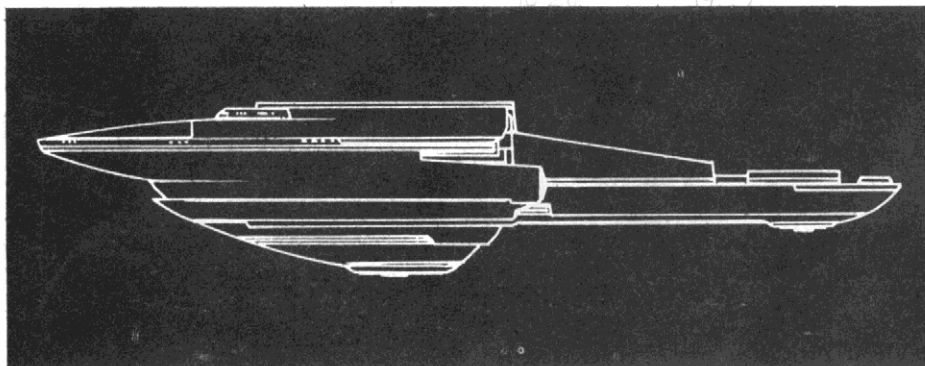



S-3 (Free Flight) Class III/IV Scout

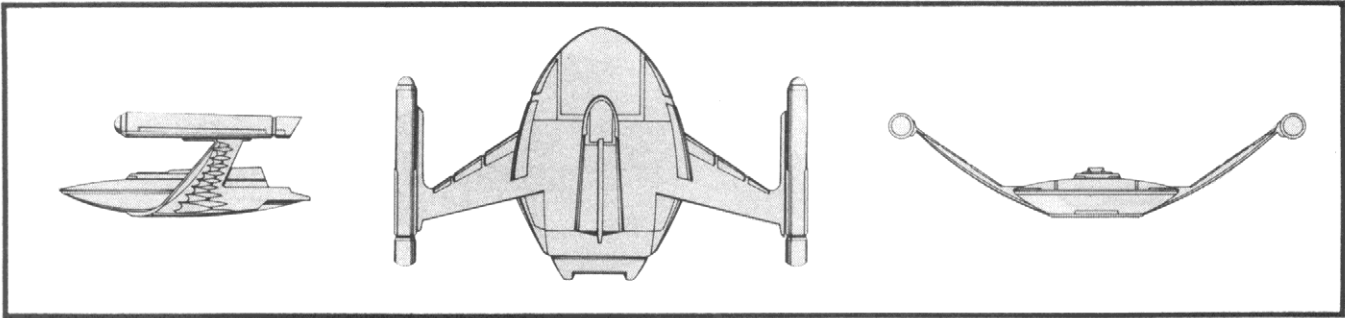

S-3 (Free Flight) CLASS III/IV SCOUT

Construction Data:

Model Numbers—	Type 1	Type 3	Type 8	Type 11
Ship Class—	III	III	IV	IV
Date Entering Service—	1/82	1/87	2/00	2/09
Approx. Number Constructed—	200	370	150	84

Hull Data:

Superstructure Points—	5	5	5	6
Damage Chart—	B	B	B	B
Size				
Length—	80 m	80 m	80 m	80 m
Width—	132 m	132 m	132 m	132 m
Height—	30 m	30 m	30 m	30 m
Weight—	15,580 mt	15,830 mt	26,780 mt	30,900 mt
Cargo				
Cargo Units—	10 SCU	10 SCU	10 SCU	10 SCU
Cargo Capacity—	500 mt	500 mt	500 mt	500 mt
Landing Capability—	Yes	Yes	Yes	Yes

Equipment Data:

Control Computer Type—	R3M	R3M	R3M	R4M
Transporters—	—	—	—	—
Standard 9-person	1	1	1	1

Other Data:

Crew—	12	12	12	12
Shuttlecraft—	None	None	None	None

Engines And Power Data:

Total Power Units Available—	21	21	23	25
Movement Point Ratio—	1/1	1/1	1/1	1/1
Warp Engine Type—	RWA-2	RWA-2	RWB-1	RWB-2
Number—	2	2	2	2
Power Units Available—	9	9	10	11
Stress Charts—	J/M	J/M	M/P	N/P
Maximum Safe Cruising Speed—	Warp 6	Warp 6	Warp 6	Warp 6
Emergency Speed—	Warp 7	Warp 7	Warp 7	Warp 7
Impulse Engine Type—	RIA-3	RIA-3	RIA-3	RIA-3
Power Units Available—	3	3	3	3

Weapons And Firing Data:

Beam Weapon Type—	RB-1	RB-2	RB-7	RB-7
Number—	1	2	2	4
Firing Arcs—	fwd	fwd	fwd	2 f/p, 2 f/s
Firing Chart—	G	K	J	J
Maximum Power—	2	2	4	4
Damage Modifiers—	None	None	—	—
+2	—	—	(1 - 6)	(1 - 6)
+1	—	—	(7 - 10)	(7 - 10)

Shields Data:

Deflector Shield Type—	RSB	RSB	RSB	RSC
Shield Point Ratio—	1/1	1/1	1/1	1/2
Maximum Shield Power—	7	7	7	7

Combat Efficiency:

D-	46.6	46.6	49.6	88.6
WDF-	0.5	1.6	4.6	9.2

Notes:

Known Sphere Of Operation: Empire interior

Data Reliability: C

Major Data Source: Contact reports from border conflicts; Project Grey Ghost data acquisition

This reserve-status class was once in the forefront of early coreward and spinward advances, accounting for a reported 60% of the contacts made with new civilizations. Known from its introduction for its speed and maneuverability, the Type 1 was found only to be lacking in the power of its weaponry. By Stardate 1/8707, the Type 3 is known to have been introduced, and, by Stardate 1/9902, the Type 1 no longer existed in the fleet.

The S-3 underwent internal changes that did not effect the overall performance of the vessel until the Type 8 was introduced about Stardate 2/0000. This new type mounted more powerful engines and weapons than earlier versions; the overall warp speed was increased. The final modification to this class was the Type 11, introduced about Stardate 2/0910; this version had an impressive array of weapons and an upgraded shield system.

At this time, all vessels of this class are believed to have been removed from active duty. Of the nearly 800 vessels constructed, about 400 were placed into reserve status and about 200 are assumed to have been lost. Most of the vessels sold are being used as light transport, though several are being used for private research; of the 176 vessels known to be operating in the civil sector, two are Type 11s and frequent the Triangle.

The class is named from the Romulan *revastal* (free flight), a reference to its speed and maneuverability.

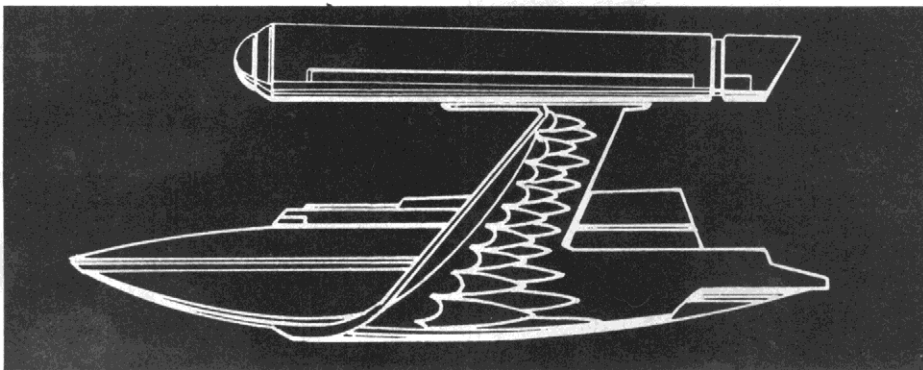



S-4 (Swift Wing) Class IV Scout

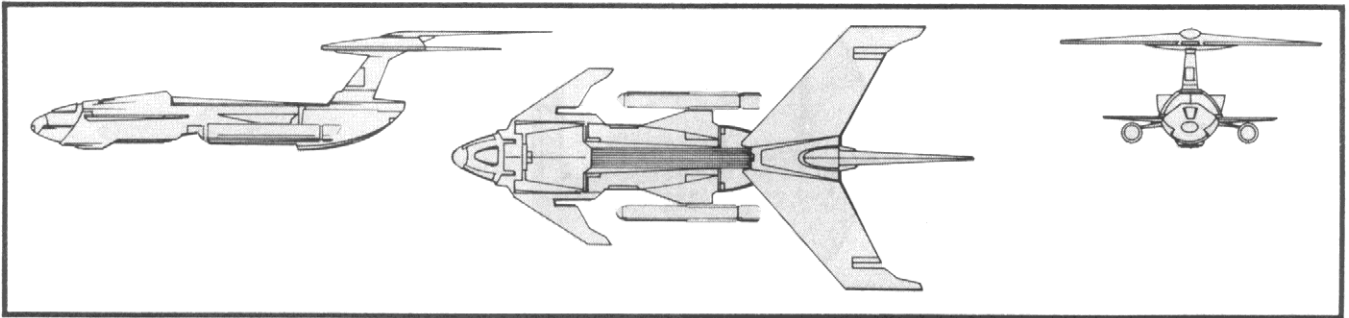

S-4 (Swift Wing) CLASS IV SCOUT

Construction Data:

Model Numbers —	Type 1
Date Entering Service —	1/94
Approx. Number Constructed —	150

Hull Data:

Superstructure Points —	5
Damage Chart —	B
Size	
Length —	120 m
Width —	60 m
Height —	28 m
Weight —	27,100 mt
Cargo	
Cargo Units —	5 SCU
Cargo Capacity —	250 mt
Landing Capability —	Yes

Equipment Data:

Control Computer Type —	R3M
Transporters —	
Standard 9-person	1

Other Data:

Crew —	28
Shuttlecraft —	None

Engines And Power Data:

Total Power Units Available —	23
Movement Point Ratio —	2/1
Warp Engine Type —	RWB-1
Number —	2
Power Units Available —	10
Stress Charts —	M/P
Maximum Safe Cruising Speed —	Warp 6
Emergency Speed —	Warp 7
Impulse Engine Type —	RIB-2
Power Units Available —	3

Weapons And Firing Data:

Beam Weapon Type —	RB-7
Number —	2
Firing Arcs —	1 f/p, 1 f/s
Firing Chart —	J
Maximum Power —	4
Damage Modifiers —	
+ 2	(1 - 6)
+ 1	(7 - 10)

Shields Data:

Deflector Shield Type —	RSB
Shield Point Ratio —	1.1
Maximum Shield Power —	7

Combat Efficiency:

D-	33.1
WDF-	4.6

Notes:

Known Sphere Of Operation: Empire-wide use as civilian craft

Data Reliability: C

Major Data Source: Triangle sector intelligence

The S-4 Class was commissioned to lead the expansion into the galactic trailing arm. To accomplish its mission, this class needed speed and maneuverability; it is reported that these sleek ships were a real joy to fly in the atmosphere due to their responsive manual controls. Its light armament was a liability, making the vessels unsuitable for combat roles and endangering crews when exploring new worlds with their own starfaring capabilities.

Due to its inability to perform its assigned tasks, the Swift Wings were not produced in any great number and were not modified or upgraded. Of the approximately 160 vessels produced, about 100 are known to be operating in the civil sector, many within the Triangle. Project Grey Ghost found no evidence of any use in the Romulan reserve fleets.

The class is named from the Romulan *delon vastam* (swift wing), in reference to its atmospheric capabilities.

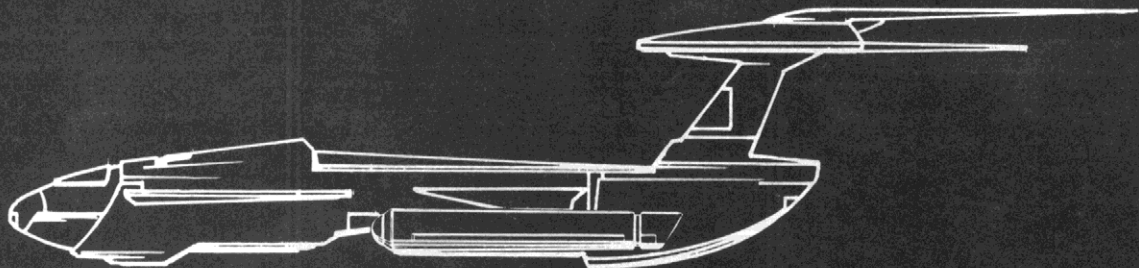



S-9 (Wind Carrier) Class V Scout

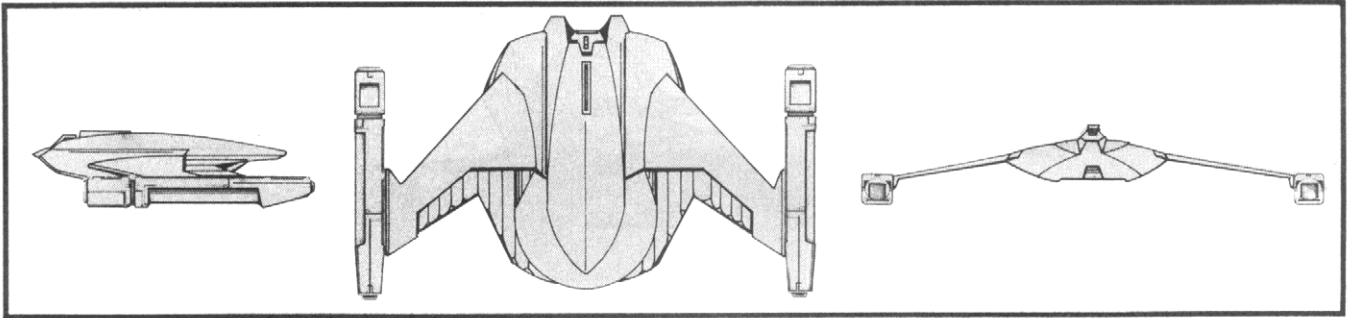

S-9 (Wind Carrier) CLASS V SCOUT

Construction Data:

Model Numbers—	Type 1	Type 4
Date Entering Service—	2/10	2/14
Approx. Number Constructed—	266	182

Hull Data:

Superstructure Points—	7	7
Damage Chart—	C	C
Size		
Length—	72 m	72 m
Width—	120 m	120 m
Height—	20 m	20 m
Weight—	44,300 mt	45,600 mt
Cargo		
Cargo Units—	60 SCU	60 SCU
Cargo Capacity—	3000 mt	3000 mt
Landing Capability—	Yes	Yes

Equipment Data:

Control Computer Type—	R3M	R3M
Transporters—		
Standard 9-person	1	1
Cargo	1	1

Other Data:

Crew—	42	42
Shuttlecraft—	None	None

Engines And Power Data:

Total Power Units Available—	23	23
Movement Point Ratio—	2/1	2/1
Warp Engine Type—	RWD-2	RWD-2
Number—	1	1
Power Units Available—	18	18
Stress Charts—	O/Q	O/Q
Maximum Safe Cruising Speed—	Warp 7	Warp 7
Emergency Speed—	Warp 8	Warp 8
Impulse Engine Type—	RIB-3	RIB-3
Power Units Available—	5	5

Weapons And Firing Data:

Beam Weapon Type—	RB-7a	RB-7a
Number—	2	4, in 2 banks of 2
Firing Arcs—	fwd	2 f.p. 2 f.s
Firing Chart—	M	M
Maximum Power—	4	4
Damage Modifiers—		
+3	(1 - 3)	(1 - 3)
+2	(4 - 9)	(4 - 9)
+1	(10 - 14)	(10 - 14)

Shields Data:

Deflector Shield Type—	RSC	RSC
Shield Point Ratio—	1/2	1/2
Maximum Shield Power—	6	6

Combat Efficiency:

D-	52.0	52.0
WDF-	6.0	12.0

Notes:

Known Sphere Of Operation: Empire frontiers

Data Reliability: E (new)

Major Data Source: Transmissions monitored by Project Grey Ghost

The S-9 Class probably was designed to replace the older S-4 (Swift Wing) as a front-line scout vessel capable of combat and exploration duties. The inadequate weaponry of its predecessor corrected by the addition of more powerful disruptors and more efficient shields, the Type 1 was a vast improvement. The Type 4 mounts two banks of two disruptors, giving the scout a better field of fire and increasing its combat efficiency beyond that of the CS-2 (Graceful Flyer), which it is believed to have also replaced. The class reportedly leads the Romulan expansion efforts spinward.

Of the approximately 450 vessels built, about 400 are reported to remain in active service and about 20 have been placed in reserve fleets. Best estimates now give 19 Type 1s operating in the civil sector; plans for a vessel now believed to be one of these have been purchased from Orion sources in the Triangle.

This class is named for *Talas Mosarum* (Wind Carrier), an ancient Romulan chieftain said to have carried the winds of Romulus with him as he travelled his territories. This leader supposedly waited to attack his enemies until storms were brewing in the area, and then would lead his armies into battle in the vanguard of the winds and rain.

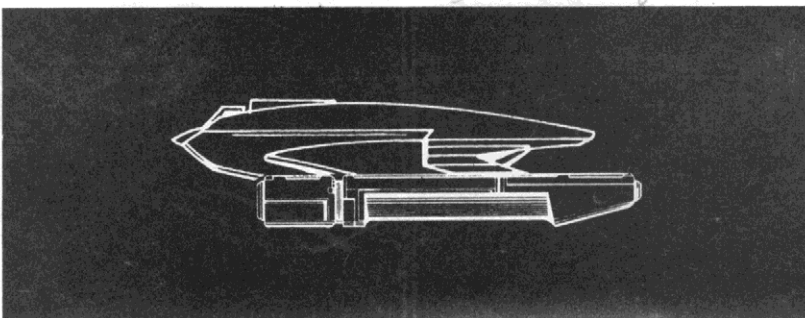



S-11 (Bird Of Prey) Class V Scout

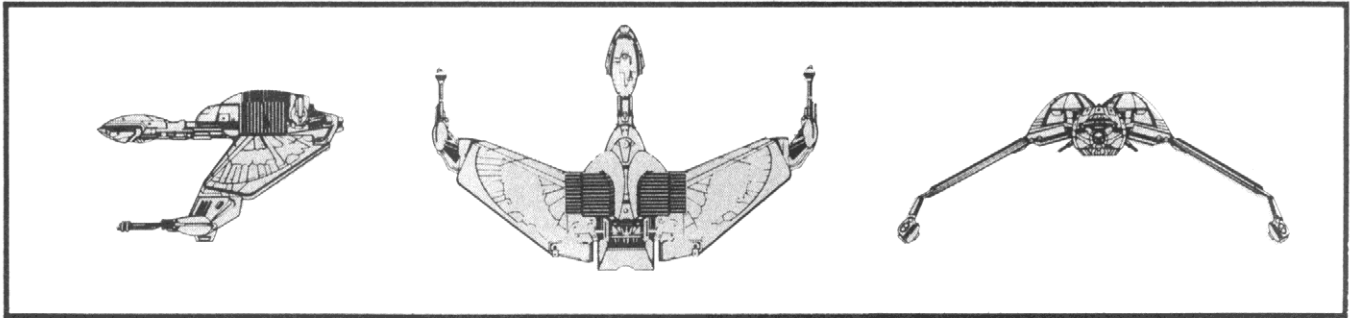

S-11 (Bird Of Prey) CLASS V SCOUT

Construction Data:

Model Numbers —	Type 1
Date Entering Service —	2/17
Approx. Number Constructed —	84

Hull Data:

Superstructure Points —	8
Damage Chart —	C
Size	
Length —	88 m
Width —	130 m
Height —	16 m
Weight —	47,800 mt
Cargo	
Cargo Units —	5 SCU
Cargo Capacity —	250 mt
Landing Capability —	Yes

Equipment Data:

Control Computer Type —	R3M
Transporters —	
Standard 9-person	1
Cloaking Device Type —	RCB
Power Requirement —	10

Other Data:

Crew —	14
Shuttlecraft —	None

Engines And Power Data:

Total Power Units Available —	30
Movement Point Ratio —	2/1
Warp Engine Type —	RWD-2
Number —	1
Power Units Available —	18
Stress Charts —	O/O
Maximum Safe Cruising Speed —	Warp 7
Emergency Speed —	Warp 8
Impulse Engine Type —	RIJ-3
Power Units Available —	12

Weapons And Firing Data:

Beam Weapon Type —	RB-7a
Number —	4, in 2 banks of 2
Firing Arcs —	2 f.p., 2 f.s.
Firing Chart —	M
Maximum Power —	4
Damage Modifiers —	
+3	(1 - 3)
+2	(4 - 9)
+1	(10 - 14)
Missile Weapon Type —	RP-2
Number —	1
Firing Arcs —	fwd
Firing Chart —	H
Power To Arm —	1
Damage —	8

Shields Data:

Deflector Shield Type —	RSC
Shield Point Ratio —	1/2
Maximum Shield Power —	6

Combat Efficiency:

D-	63.4
WDF-	27.6

Notes:

Known Sphere Of Operation: Empire-wide use

Data Reliability: C (upgrade)

Major Data Source: Scanned by Project Grey Ghost; Triangle sector intelligence

The improved S-11 (Bird of Prey) is probably the most formidable of all enemy scout ships facing the Federation. It is the first blending of Klingon and Romulan technologies to come from the exchange agreements between these powers. The improved power plant is housed in a Klingon-designed compartment made for survivability during combat; the addition of the photon torpedo tube is a direct result of Klingon influence.

The S-11 is believed to be the first scout ship to use the cloaking device for deep-space penetrations of UFP and Klingon territories, which theretofore have been performed only by larger capital ships. The Romulan High Command apparently now feels that the survival potential of the S-11 is just as great as for larger vessels, probably because of the scout's size and cloaking ability.

As of this date, only the Type 1 is known to exist. Consistent with Romulan methods, other types probably are in the making, if not already coming on line. None of these vessels have passed into the private sector at this time; 82 are known to actively patrol both the Klingon and Federation borders. The Klingon version of this vessel is in Star Fleet possession, captured by Admiral James T. Kirk.

This design so intrigued the Klingons that, as part of the treaties of Stardate 2/1801, they insisted that a small number of these vessels be exchanged for plans of improved Klingon weaponry. At the signing of the treaty, seven of these vessels (named *Strong Bird* by the Klingons) were given to the Klingons, along with a modified version of the famed cloaking device. Within a year, several larger prototypes of this design appeared in the Klingon inventory, a mimicry the Romulans do not find flattering. As the relationship between the Klingons and Romulans has become more strained, Romulan commanders are reported to be increasingly nervous at the fact of having to someday face these giant clones.

The class takes its name from the famed V-8 Class cruiser, because of the similarity in the designs of the two vessels. It is proving to be worthy of replacing the cruiser's notoriety as a hit-and-run vessel.

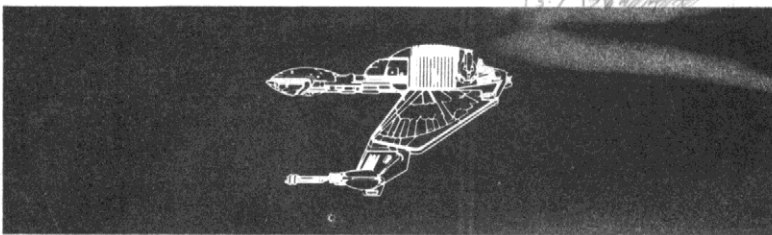



I-4 (Graffler) Class VII/IX Freighter

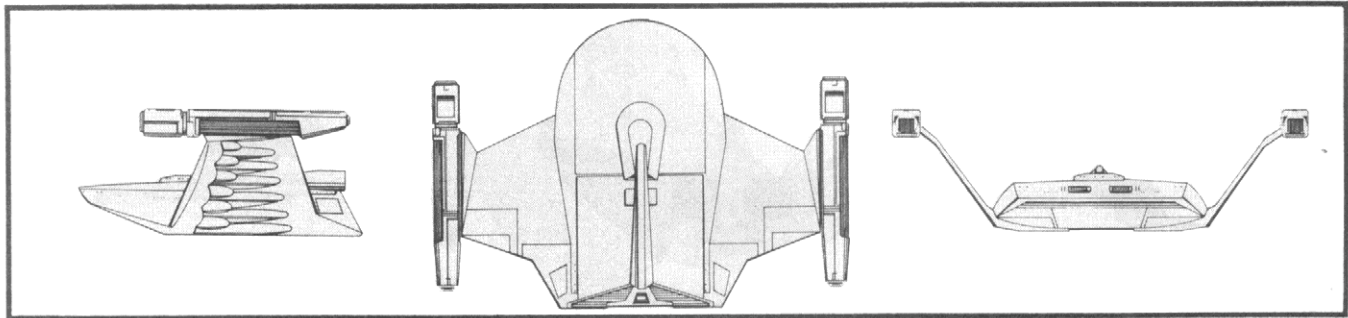

I-4 (Graffler) CLASS VII/IX FREIGHTER

Construction Data:

Model Numbers —	Type 1	Type 3
Ship Class —	VII	IX
Date Entering Service —	1/98	2/08
Approx. Number Constructed —	80	160

Hull Data:

Superstructure Points —	15	15
Damage Chart —	B	B
Size		
Length —	240 m	240 m
Width —	180 m	180 m
Height —	60 m	60 m
Weight —	86,200 mt	126,700 mt
Cargo		
Cargo Units —	8000 SCU	9400 SCU
Cargo Capacity —	400,000 mt	470,000 mt
Landing Capability —	None	None

Equipment Data:

Control Computer Type —	R4M	R4M
Transporters —		
Standard 9-person	2	2
Small cargo	3	3
Large cargo	3	3
Cloaking Device Type —	None	None

Other Data:

Crew —	40	40
Shuttlecraft —	4	4

Engines And Power Data:

Total Power Units Available —	35	44
Movement Point Ratio —		
Unloaded	3/1	4/1
Loaded	5/1	7/1
Warp Engine Type —	RWD-1	RWF-1
Number —	2	2
Power Units Available —	16	18
Stress Charts —	O Q	G L
Maximum Safe Cruising Speed —		
Unloaded	Warp 6	Warp 7
Loaded	Warp 4	Warp 4
Emergency Speed —		
Unloaded	Warp 7	Warp 9
Loaded	Warp 5	Warp 6
Impulse Engine Type —	RIB-2	RID-2
Power Units Available —	3	8

Weapons And Firing Data:

	None	None
--	------	------

Shields Data:

Deflector Shield Type —	RSG	RSH
Shield Point Ratio —	1/1	1/1
Maximum Shield Power —	12	8

Combat Efficiency:

D-	44.5	41.5
WDF-	0	0

Notes:

Known Sphere Of Operation: Empire-wide use

Data Reliability: C

Major Data Source: Triangle Sector Intelligence

Introduced about Stardate 1/98, the Type 1 was considered to be state-of-the-art in freighter design at the time but it was soon realized that it was underpowered for the cargo it could carry in its internal cargo bays. The Type 3, introduced about Stardate 2/0801, mounted a more powerful drive system that was capable of maintaining higher warp speeds. There was a trade-off in this increased performance and that was the slight loss of maneuverability and available shielding. By Stardate 2/12, all Type 1s in the Military and Exploration Divisions were refitted to Type 3s. Of the approximately 250 built, only about 150 remain in active service; about 60 each are assigned to the Colonization and Military Divisions, and about 30 to the Exploration Division.

Although the navy has stopped contracting for the Type 1, it is still in production and being sold to the civil sector. The current production rate for the navy is estimated to be 10 Type 3s per year and for the civil sector a total of about 15 per year, of which ten are Type 3s and five are Type 1s. Like other Romulan commercial vessels, some of these ships are owned and operated within the Triangle.

The class is named for the *graffler*, an amphibian native to Perhonies. These small creatures have pouches that line their undersides and have an uncanny flap device that allows them to carry food and young underwater without becoming wet.

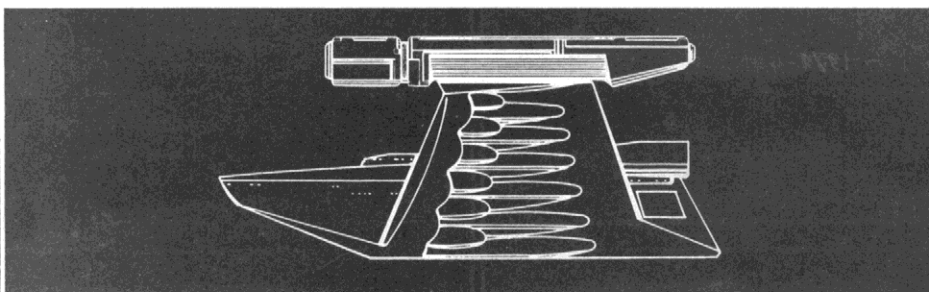



I-7 (Vespin) Class XI Freighter

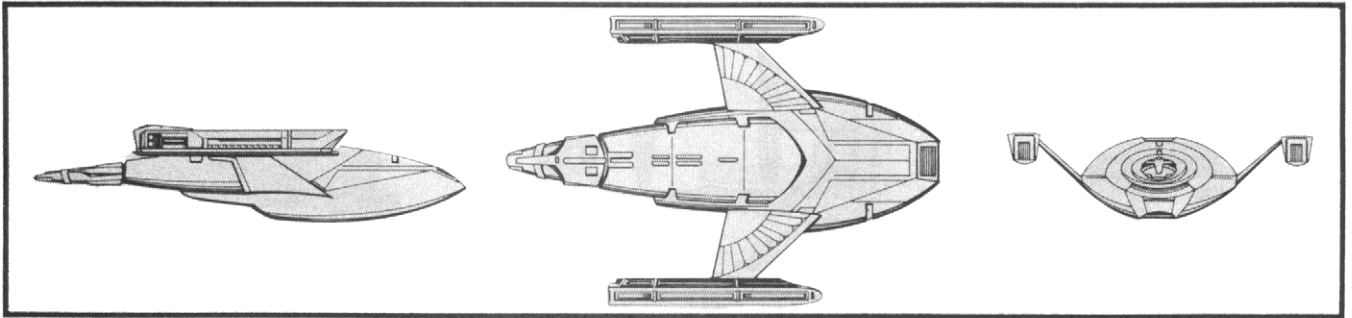

I-7 (Vespin) CLASS XI FREIGHTER

Construction Data:

Hull/Ship Numbers—	Type 1
Model Numbers—	2/13
Date Entering Service—	90
Approx. Number Constructed—	

Hull Data:

Superstructure Points—	11
Damage Chart—	B
Size	
Length—	270 m
Width—	182 m
Height—	54 m
Weight—	121,000 mt

Cargo

Cargo Units—	9600 SCU
Cargo Capacity—	480,000 mt
Landing Capability—	None

Equipment Data:

Control Computer Type—	R4M
Transporters—	
Standard 9-person	2
Emergency 20-person	1
Small cargo	4
Large cargo	4
Cloaking Device Type—	None

Other Data:

Crew—	86
Shuttlecraft—	4

Engines And Power Data:

Total Power Units Available—	40
Movement Point Ratio—	
Unloaded	4/1
Loaded	6/1
Warp Engine Type—	RWF-1
Number—	2
Power Units Available—	18
Stress Charts—	G/L
Maximum Safe Cruising Speed—	
Unloaded	Warp 7
Loaded	Warp 4
Emergency Speed—	
Unloaded	Warp 9
Loaded	Warp 6
Impulse Engine Type—	RID-1
Power Units Available—	4

Weapons And Firing Data:

None

Shields Data:

Deflector Shield Type—	RSK
Shield Point Ratio—	1/2
Maximum Shield Power—	12

Combat Efficiency:

D-	61.7
WDF-	0

Notes:

Known Sphere Of Operation: Empire-wide use

Data Reliability: C

Major Data Source: Triangle Sector Intelligence

Though designed to be used as a freighter, the I-7 can be converted into a troop transport on short notice, a part of the contract for service that has proven its worth. The ships are capable of carrying 480,000 metric tons of cargo or up to 3,200 troops. When the I-7 entered service approximately Stardate 2/13, they were assigned to the Military and Outpost Divisions, which made them easily accessible for conversion and put them under the command of the divisions that would require their services.

When the I-7 is used to carry troops, half of the cargo transporters are removed and replaced with 16 transporter stations capable of beaming 14 troopers per station. This allows 242 soldiers to be beamed to the surface every two minutes or the entire contingent of troops in less than 30 minutes. The remaining cargo transporters are used to beam down support equipment such as armored vehicles and artillery.

Of the approximately 90 built, nearly all are in active service. Current production rates on this vessel are estimated at eight per year.

The I-7 is not as widely used by the civil sector as are the other freight carriers of the Star Navy, likely because of the recall/refit clause reported to be required of all civilian purchasers. It is estimated that only 60 of these vessels are being used by private industry. Several are known to be operating in the Triangle.

The class is named for Vespin, a trade city in the Kalabestasz system.

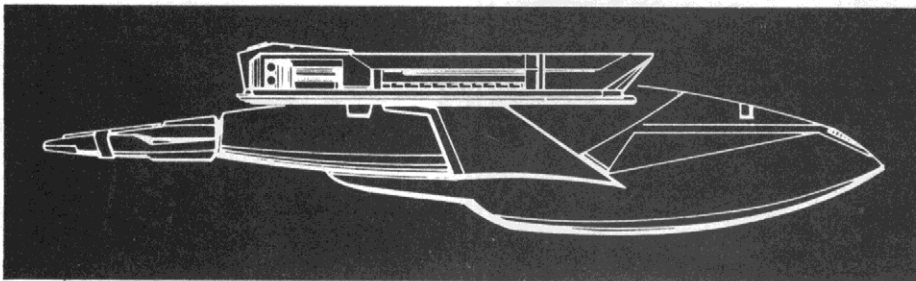



J-3 (Starlifter) Class VI/IX Freighter

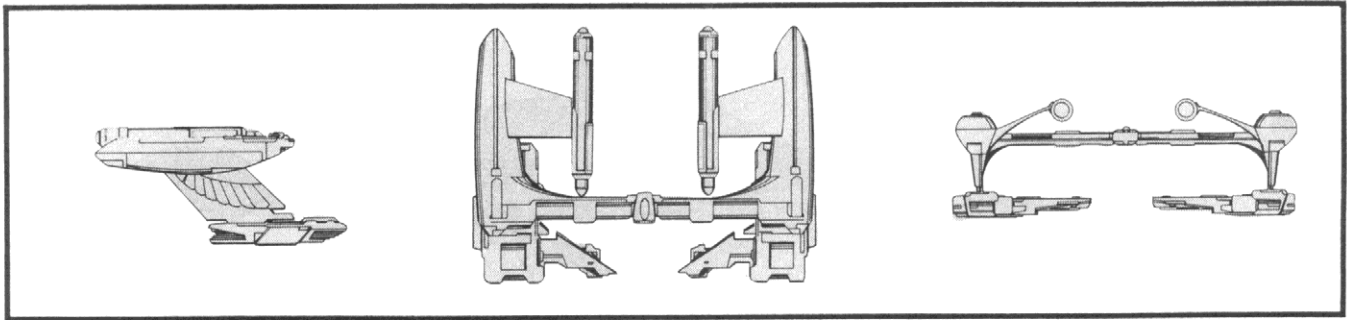

J-3 (Starlifter) CLASS VI/IX FREIGHTER

Construction Data:

	Type 2	Type 9	Type 14
Model Numbers —	VI	VII	IX
Ship Class —	VI	VII	IX
Date Entering Service —	1/90	1/98	2/12
Approx. Number Constructed —	330	260	110

Hull Data:

	Type 2	Type 9	Type 14
Superstructure Points —	10	12	12
Damage Chart —	A	A	A
Size			
Length —	180 m	180 m	180m
Width —	242 m	242 m	242m
Height —	81 m	81 m	81m
Weight —	78,700 mt	81,700 mt	122,300mt
Cargo			
Internal Cargo Units —	10 SCU	10 SCU	10 SCU
Internal Cargo Capacity —	500 mt	500 mt	500 mt
Cargo Transport Capacity —	200,000 mt	410,000 mt	500,000 mt
Landing Capability —	None	None	None

Equipment Data:

	Type 2	Type 9	Type 14
Control Computer Type —	R4M	R4M	R4M
Transporters —			
Standard 9-person Cargo	1	1	1

Other Data:

	Type 2	Type 9	Type 14
Crew —	34	36	32
Shuttlecraft —	1	1	1

Engines And Power Data:

	Type 2	Type 9	Type 14
Total Power Units Available —	33	35	44
Movement Point Ratio —			
Unloaded	3/1	3/1	4/1
Loaded	5/1	5/1	7/1
Warp Engine Type —	RWD-1	RWD-1	RWF-1
Number —	2	2	2
Power Units Available —	16	16	18
Stress Charts —	O O	O O	G L
Maximum Safe Cruising Speed —			
Unloaded	Warp 6	Warp 6	Warp 7
Loaded	Warp 4	Warp 4	Warp 4
Emergency Speed —			
Unloaded	Warp 7	Warp 7	Warp 9
Loaded	Warp 5	Warp 5	Warp 6
Impulse Engine Type —	RIB-1	RIC-2	RID-2
Power Units Available —	2	4	8

Weapons And Firing Data:

	Type 2	Type 9	Type 14
	None	None	None

Shields Data:

	Type 2	Type 9	Type 14
Deflector Shield Type —	RSG	RSG	RSK
Shield Point Ratio —	1/1	1/1	1/2
Maximum Shield Power —	12	12	12

Combat Efficiency:

	Type 2	Type 9	Type 14
D-	47.8	51.2	47.2
WDF-	0	0	0

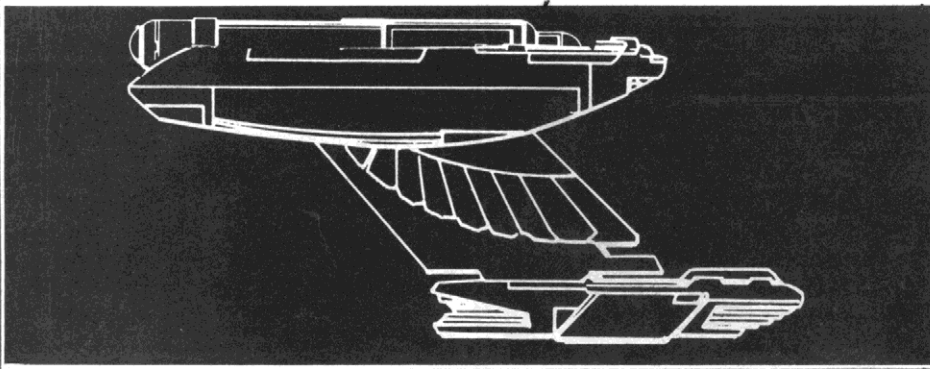

Notes:

Known Sphere Of Operation: Empire-wide use

Data Reliability: C

Major Data Source: Triangle Sector Intelligence

One of the oldest transport ships in known space, the *J-3* Class tug is designed to tow cargo arranged in pods attached one to the other in a chain behind the ship.

About Stardate 1/90, the Type 2 was introduced into service; although it does not have the cargo towing capabilities of later models, it is still in production, because of its reliability and the need for a vessel to move cargos in its specific tonnage range. By Stardate 1/98, the class had undergone several unsuccessful modifications attempting to allow the design to use the RWD-1 warp engine to its fullest capacity; the Type 9 altered the hull configuration, relieving the problem. The Type 9 also had slightly more maneuvering power, greater superstructure strength, and the ability to tow twice as much cargo. The Type 14, capable of pulling 25% more cargo than the Type 9 at higher warp speeds, mounts more efficient shields and engines.

Current production estimates show about 15 of these vessels being produced a year. Of the approximately 700 vessels built, about 500 remain in service with the navy. Something over 100 have been sold to the civil sector.

The class is named from the Romulan *ustalam stelas* (lifter of stars), in reference to its towing capabilities.



J-4 (Baydron) Class V Transport

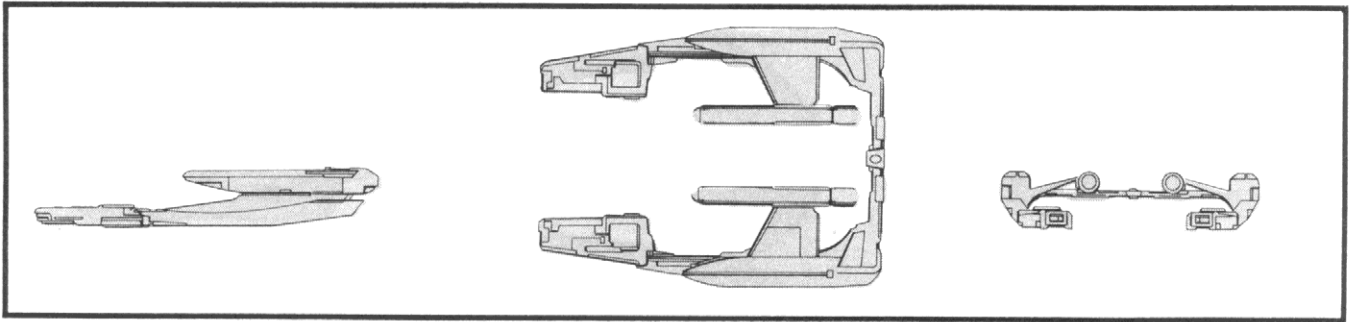

J-4 (Baydron) CLASS V TRANSPORT

Construction Data:	
Model Numbers—	Type 1
Date Entering Service—	1/96
Approx. Number Constructed—	250
Hull Data:	
Superstructure Points—	8
Damage Chart—	C
Size	
Length—	200 m
Width—	150 m
Height—	35 m
Weight—	55,600 mt
Cargo	
Internal Cargo Units—	60 SCU
Internal Cargo Capacity—	3000 mt
Cargo Transport Capacity—	160,000 mt
Landing Capability—	None
Equipment Data:	
Control Computer Type—	R4M
Transporters—	
Standard 9-person	1
Emergency 20-person	
Cargo	1
Other Data:	
Crew—	32
Passengers—	40
Shuttlecraft—	1
Engines And Power Data:	
Total Power Units Available—	36
Movement Point Ratio—	
Unloaded	2/1
Loaded	4/1
Warp Engine Type—	
Number—	2
Power Units Available—	15
Stress Charts—	N/Q
Maximum Safe Cruising Speed—	
Unloaded	Warp 6
Loaded	Warp 4
Emergency Speed—	
Unloaded	Warp 8
Loaded	Warp 6
Impulse Engine Type—	
Power Units Available—	RIB-3
	5
Weapons And Firing Data:	
	None
Shields Data:	
Deflector Shield Type—	RSD
Shield Point Ratio—	1.1
Maximum Shield Power—	8
Combat Efficiency:	
D-	44.9
WDF-	.0

Notes:

Known Sphere Of Operation: Empire-wide use

Data Reliability: B

Major Data Source: Triangle Sector Intelligence

The J-4, which transports cargo in pods that are pushed from behind, entered service about Stardate 1/96 and has not been modified. These vessels are extremely reliable and easy to maintain, which makes them very cost effective. It carries slightly more cargo and is more maneuverable than the J-8 but is not as fast; it requires fewer crewmembers and has facilities for 40 passengers. Of the more than 240 built for the navy, about 180 remain in service.

So popular is this ship that its manufacturer began selling it to private industry within six months after its delivery to the navy. It is estimated that over 250 of these vessels have been sold to private industry, and several of these are owned and operated by private concerns located in the Triangle. Production capacity of this vessel is estimated at ten per year for the navy and 20 per year for private industry.

The class is named to honor Senator Baydron, the senator from Messala, who was instrumental in establishing the current trade accords.

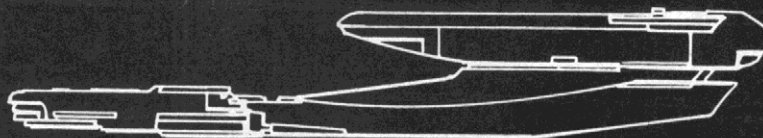



J-8 (Moorabbin) Class IV Transport

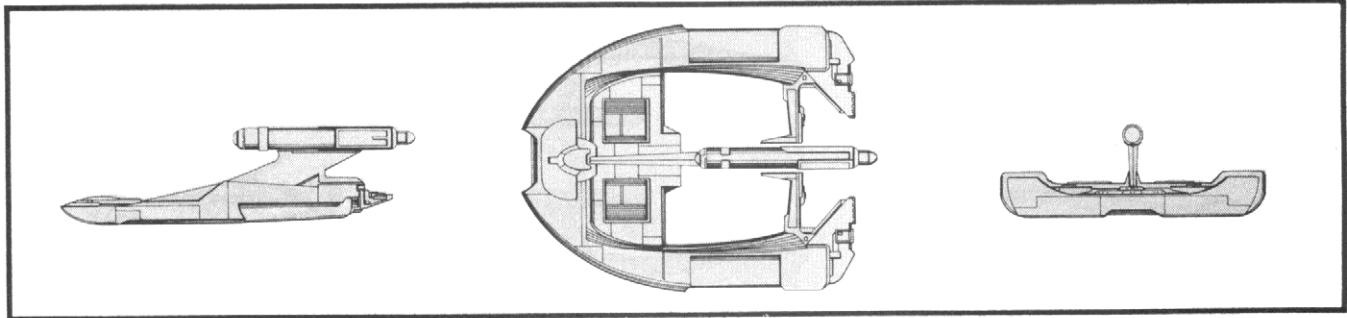

J-8 (Moorabbin) CLASS IV TRANSPORT

Construction Data:

Model Numbers —	Type 1
Date Entering Service —	2/00
Approx. Number Constructed —	202

Hull Data:

Superstructure Points —	10
Damage Chart —	C
Size	
Length —	201 m
Width —	152 m
Height —	52 m
Weight —	35,700 mt

Cargo

Internal Cargo Units —	10 SCU
Internal Cargo Capacity —	500 mt
Cargo Transport Capacity —	150,000 mt
Landing Capability —	None

Equipment Data:

Control Computer Type —	R3M
Transporters —	
Standard 9-person	2
Small cargo	1

Other Data:

Crew —	67
Shuttlecraft —	3

Engines And Power Data:

Total Power Units Available —	20
Movement Point Ratio —	
Unloaded	2/1
Loaded	4/1
Warp Engine Type —	RWD-1
Number —	1
Power Units Available —	15
Stress Charts —	N O
Maximum Safe Cruising Speed —	
Unloaded	Warp 7
Loaded	Warp 5
Emergency Speed —	
Unloaded	Warp 8
Loaded	Warp 6
Impulse Engine Type —	RIC-2
Power Units Available —	4

Weapons And Firing Data:

None

Shields Data:

Deflector Shield Type —	RSJ
Shield Point Ratio —	1.1
Maximum Shield Power —	15

Combat Efficiency: D-	48.8
WDF-	0

Notes:

Known Sphere Of Operation: Empire-wide use

Data Reliability: A

Major Data Source: Vessel in Star Fleet possession

The J-8, which tows cargo pods similar to but smaller than those towed by the J-3, entered service about Stardate 2/00 and has not been changed or modified since. Of the approximately 200 ships built for the navy, more than 160 remain in service.

This vessel has been so successful that the manufacturer began placing them in the civil sector shortly after their introduction, and they are probably the most common small transport vessels built by the Romulans to date. It is estimated that over 250 ships of this type have been manufactured and sold to private industry. Several of these are known to be owned and operated out of the Triangle. With current production capacity estimated at 15 per year for the navy and 20 per year for the civil sector, these ships will be a common sight for many years to come.

The class takes its name from Moorabbin, a wellknown trade center on Gorwah.

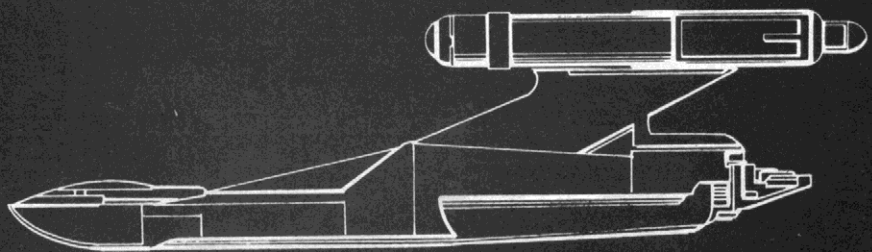



H-4 (Praetor) Class II Warpshuttle

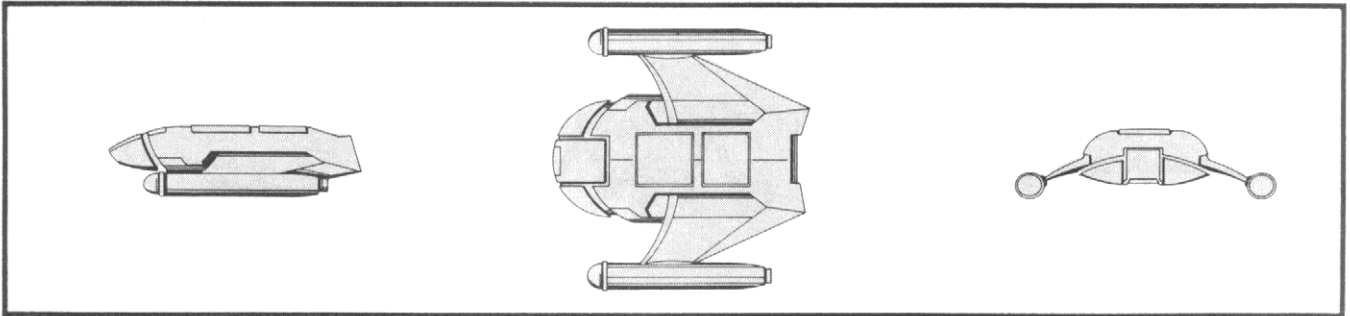

H-4 (PRAETOR) CLASS II WARPSHUTTLE

Construction Data:

Model Numbers —	Type 1	Type 2
Date Entering Service —	1.90	2.10
Approx. Number Constructed —	1400	1000

Hull Data:

Superstructure Points —	2	2
Damage Chart —	C	C
Size		
Length —	20 m	20 m
Width —	21 m	21 m
Height —	6 m	6 m
Weight —	9970 mt	10,840 mt
Cargo		
Cargo Units —	10 SCU	10 SCU
Cargo Capacity —	500 mt	500 mt
Landing Capability —	Yes	Yes

Equipment Data:

Control Computer Type —	R2M	R3M
Transporters —	None	None

Other Data:

Crew —	2	2
Passengers —	8	8

Engines And Power Data:

Total Power Units Available —	14	20
Movement Point Ratio —	1/1	1/1
Warp Engine Type —	RWA-1	RWA-2
Number —	2	2
Power Units Available —	6	9
Stress Charts —	M.O	J.M
Maximum Safe Cruising Speed —	Warp 6	Warp 7
Emergency Speed —	Warp 7	Warp 8
Impulse Engine Type —	RIA-2	RIA-2
Power Units Available —	2	2

Weapons And Firing Data:

	None	None
--	------	------

Shields Data:

Deflector Shield Type —	RSA	RSA
Shield Point Ratio —	1.1	1.1
Maximum Shield Power —	5	5

Combat Efficiency:

D-	29.8	38.3
WDF-	0	0

Notes:

Known Sphere Of Operation: Empire-wide use

Data Reliability: A

Major Data Source: Vessel in Star Fleet possession; Triangle Sector Intelligence

The more popular of the two major warpshuttles, the *H-4* lives up to its name (*Praetor* translates as 'leader'). Its spacious quarters are the most luxurious of all Romulan shuttles, and, therefore, makes for the most desired and comfortable travel. With a crew of two and passenger facilities for eight, it is considered to be large for the mission requirements. It is found either ground-based or attached to an outpost or orbital station, probably due to the vessel's size, but some are known to be carried aboard Class V or larger vessels. The *H-4* carries out courier and VIP transport duties for both the Navy and government agencies throughout the Empire; as it is not armed, it is not usually seen in sensitive areas.

Production of the Type 1 appears to have slowed drastically after the introduction of the Type 2. Sources report that as more and more of the Type 2s became available, the Type 1s were taken out of production, and those existing models were refit and modified as Type 2s. The Type 2s use a newer, lighter version of the same engine, which requires less space and allows for more room in the crew compartments.

Of the approximately 2500 *H-4* warpshuttles built, about 2,000 are still in service. About 30% of the remaining vessels have been lost or destroyed; another 40% are in reserve fleets. By best count, at least 28 Type 1s and 121 Type 2s are operating within the civil sector. Current production capabilities are estimated to add an additional 50 Type 2s per year to the number in service.

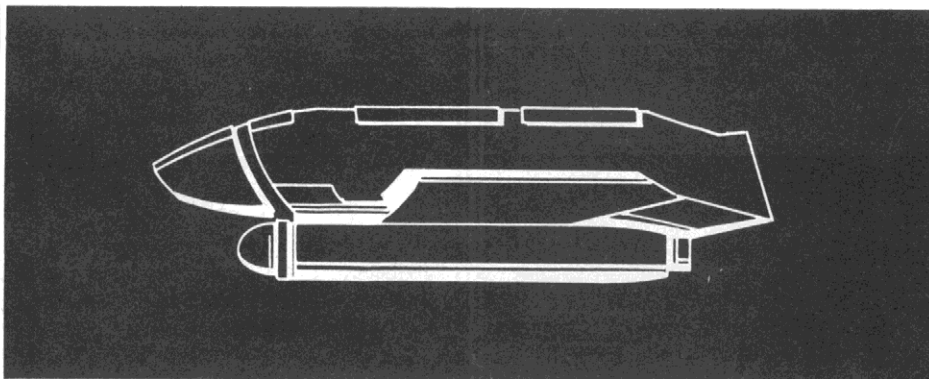



H-5 (Ras Lovah) Class I H-5 Warpshuttle

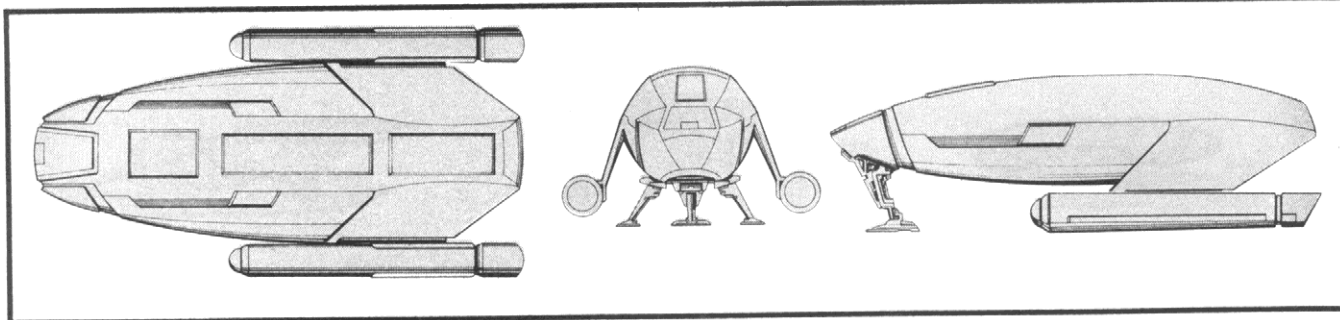

H-5 (Ras Lovah) CLASS I H-5 WARPSHUTTLE

Construction Data:

Model Numbers —	Type 1	Type 3
Date Entering Service —	1/97	2/14
Approx. Number Constructed —	850	500

Hull Data:

Superstructure Points —	1	1
Damage Chart —	C	C
Size		
Length —	38 m	38m
Width —	20 m	20m
Height —	12 m	12m
Weight —	4850 mt	4650mt
Cargo		
Cargo Units —	16 SCU	16 SCU
Cargo Capacity —	900 mt	900mt
Landing Capability —	Yes	Yes

Equipment Data:

Control Computer Type —	R1M	R1M
Transporters —		
Standard 3-person	1	1

Other Data:

Crew —	2	2
Passengers —	14	14

Engines And Power Data:

Total Power Units Available —	8	10
Movement Point Ratio —	1/3	1/3
Warp Engine Type —	RWA-1	RWA-2
Number —	1	1
Power Units Available —	6	8
Stress Charts —	K/M	J/L
Maximum Safe Cruising Speed —	Warp 7	Warp 7
Emergency Speed —	Warp 8	Warp 8
Impulse Engine Type —	RIA-2	RIA-2
Power Units Available —	2	2

Weapons And Firing Data:

	None	None
--	------	------

Shields Data:

Deflector Shield Type —	RSA	RSA
Shield Point Ratio —	1:1	1:1
Maximum Shield Power —	5	5

Combat Efficiency:

D-	42.4	50.9
WDF-	0	0

Notes:

Known Sphere Of Operation: Empire-wide use

Data Reliability: A

Major Data Source: Types 1 and 3 have been examined by Star Fleet personnel; Triangle sector intelligence

The H-5 warpshuttle, one of the most common types found in the Romulan Empire, is used to transport passengers and act as a courier. Although its exterior dimensions would make it seem to have a roomy interior, it really is very cramped because of its large cargo bay. Its small crew and passenger quarters reportedly make the ship unpopular with travelers and crews alike; when it is used as a courier, the crew are said to often occupy the unused staterooms. Named for an early explorer of Romulus, this craft perpetuates the tradition that adventurers and explorers neither live nor travel in comfort. Because of Romulan need to conserve resources, and because it is unnecessary to maintain an armament system for vessels that are exposed to the hazards of the border areas for only a brief period, these ships are unarmed.

The Type 3 appears to have completely replaced the Type 1s within the fleet, but some Type 1s still remain in reserve fleets. The newer model has a more powerful warp engine and impulse engine, making operation of the ship more efficient. The Type 2 appears to have been a failure.

Of the 1300 H-5s built, about 800 serve in the fleet, about 100 in reserve fleets, and 300 or so have been lost or destroyed. Best estimates show 86 Type 1s and 22 Type 2s operating in the civil sector; two Type 1s operate exclusively in the Triangle.

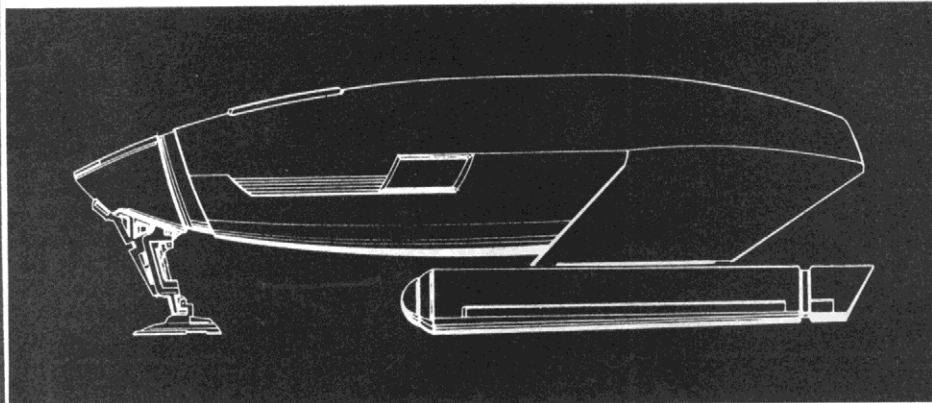



E-5 (Little Nest) Class VII Repair Tender

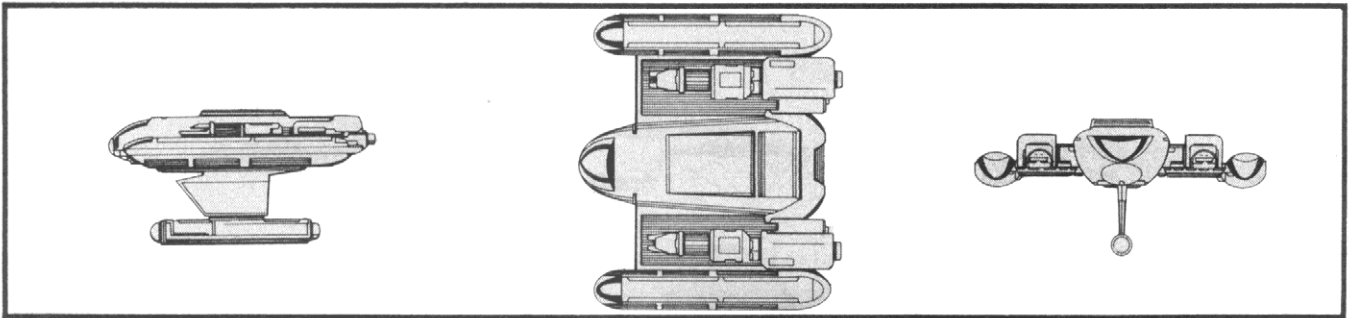

E-5 (Little Nest) CLASS VII REPAIR TENDER

Construction Data:	
Model Numbers —	Type 1
Date Entering Service —	2/04
Approx. Number Constructed —	250
Hull Data:	
Superstructure Points —	10
Damage Chart —	B
Size	
Length —	102 m
Width —	110 m
Height —	50 m
Weight —	46,100 mt
Cargo	
Cargo Units —	300 SCU
Cargo Capacity —	15,000 mt
Landing Capability —	None
Equipment Data:	
Control Computer Type —	RCC
Transporters —	
Standard 9-person	2
Small cargo	2
Large cargo	2
Other Data:	
Crew —	114
Shuttlecraft —	12
Engines And Power Data:	
Total Power Units Available —	20
Movement Point Ratio —	2/1
Warp Engine Type —	RWD-1
Number —	1
Power Units Available —	15
Stress Charts —	N/O
Maximum Safe Cruising Speed —	Warp 7
Emergency Speed —	Warp 8
Impulse Engine Type —	RIB-3
Power Units Available —	5
Weapons And Firing Data:	
	None
Shields Data:	
Deflector Shield Type —	RSD
Shield Point Ratio —	1/1
Maximum Shield Power —	8
Combat Efficiency:	
D-	43.6
WDF-	0

Notes:

Known Sphere Of Operation: Empire-wide use

Data Reliability: A

Major Data Source: Vessel in Star Fleet possession

The E-5 repair tenders, which came into service about Stardate 2/04, are fleet service and support ships that extend war vessels' time-on-station and that facilitate frontline repair during war. All Romulan fleets contain several of these useful vessels so that in-transit repairs are possible for individual ships. It is a common sight at all border outposts that maintain an F-2 repair and construction facility.

The E-5 uses its two retractable arms to position large components and place them in their mountings. Once placed, the components can be fitted properly by the small work pods listed as shuttlecraft in the tender's statistics. These small pods also have retractable arms that are used for final fitting or positioning. The pods are also capable of completing most external repair jobs with the wide array of attachments for their little arms. If more detailed work than the pod can perform is required, speciallysuited engineers will finish the job.

Current production estimates show about nine of these vessels being built per year, but this is a peacetime production goal that would be greatly increased during wartime. Of the approximately 250 built, about 190 remain in service. About 30 have been sold to the civil sector, four of which are operated in conjunction with the independent F-2 facility orbiting Freeman's Port in the Triangle.

The class is named from the Romulan *narvasam'al* (little nest).

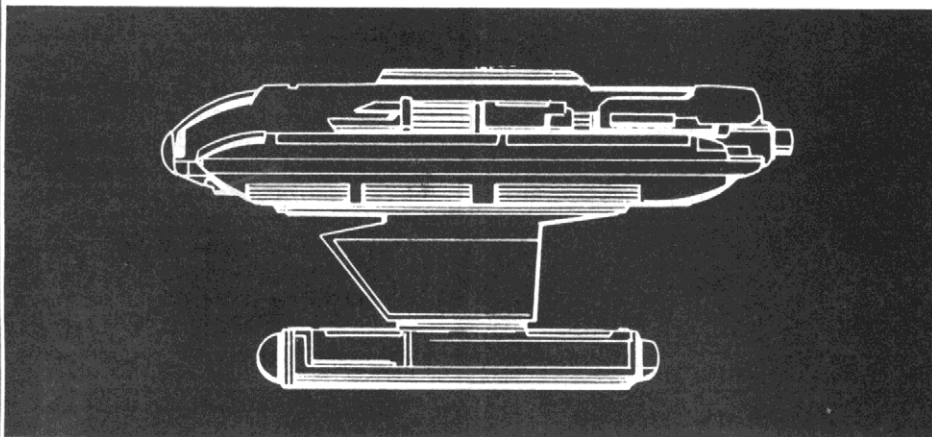



F-2 (Nestar) Class Repair Facility

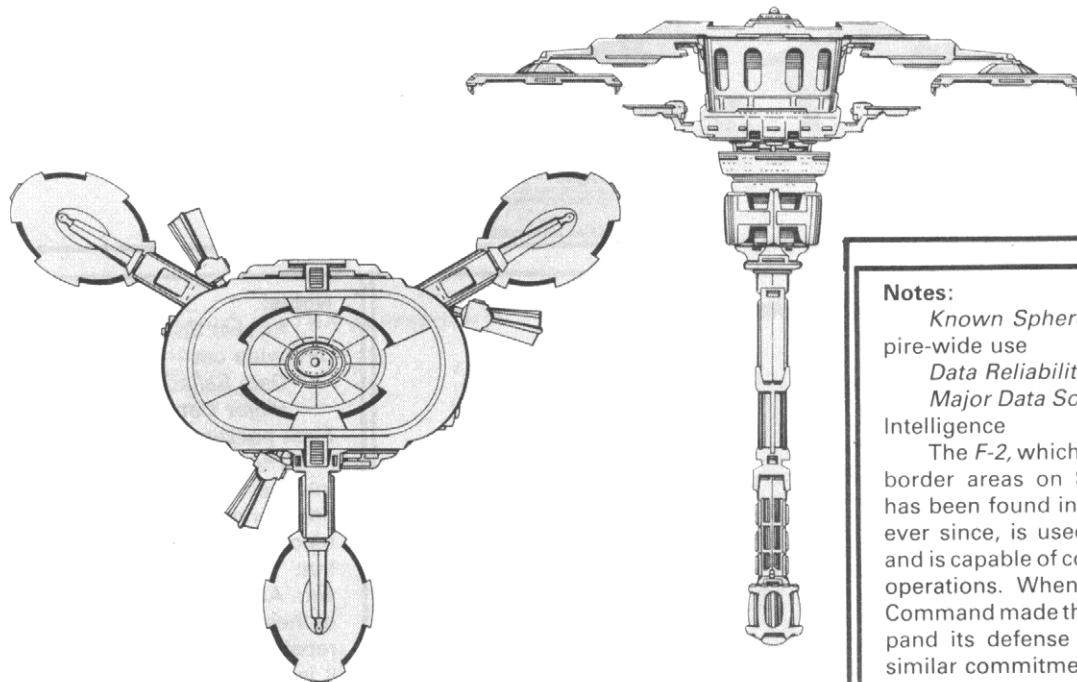

Notes:

Known Sphere Of Operation: Empire-wide use

Data Reliability: B

Major Data Source: Klingon Sector Intelligence

The F-2, which first appeared along border areas on Stardate 1/8504 and has been found in increasing numbers ever since, is used to repair starships and is capable of complete construction operations. When the Romulan High Command made the commitment to expand its defense posts, they made a similar commitment to create frontline construction and repair facilities, because this capability would allow their ships to operate for longer periods of time in or near enemy sectors, giving a constant military presence there.

The Type 1 facility was introduced into service about Stardate 1/85. The Type 7, introduced about Stardate 2/02, carried a slightly larger crew complement, had increased passenger facilities, and mounted more powerful shielding systems. Although known as a mobile repair facility, they are not capable of travelling any distance under their own power. They have only correctional navigation thrusters that allow them to maintain whatever orbital position is necessary. Most actually have been built in place, though some have been transported to their present locations.

Of the approximately 90 built, most are still on station and functioning at normal capacity. An additional F-2 was built in orbit around Freeman's Port in the Triangle; operated by a private concern, it takes advantage of that planet's port to draw customers.

The class is named from the Romulan *narvasam stelas* (nest of stars), in reference to its construction role in the Road to the Stars.

F-2 (Nestar) CLASS REPAIR FACILITY

Construction Data:

<i>Model Numbers —</i>	Type 1	Type 7
<i>Date Entering Service —</i>	1/85	2/02
<i>Approx. Number Constructed —</i>	30	60

Hull Data:

<i>Superstructure Points —</i>	4	6
<i>Damage Chart —</i>	C	C
Size		
Diameter —	780 m	780 m
Height —	800 m	800 m
Weight —	127,000 mt	141,000 mt
Storage		
Cargo Units —	200 SCU	200 SCU
Storage Capacity —	10,000 mt	10,000 mt

Equipment Data:

<i>Transporters —</i>		
Standard 9-person	2	2
Emergency 20-person	1	1
Cargo	1	1

Other Data:

<i>Crew —</i>	163	178
<i>Other Personnel —</i>	150	220
<i>Shuttlecraft —</i>	2	2

Engines And Power Data:

<i>Total Power Units Available —</i>	16	16
<i>Impulse Engine Type —</i>	RIPG-1	RIPG-1
<i>Power Units Available —</i>	16	16

Weapons And Firing Data:

	None	None
--	------	------

Shields Data:

<i>Deflector Shield Type —</i>	RSD	RSF
<i>Shield Point Ratio —</i>	1/1	1/1
<i>Maximum Shield Power —</i>	6	15

Combat Efficiency:

D-	37.2	53.1
WDF-	0	0

37

53



X-3 (Aviary) Border Defense Outpost

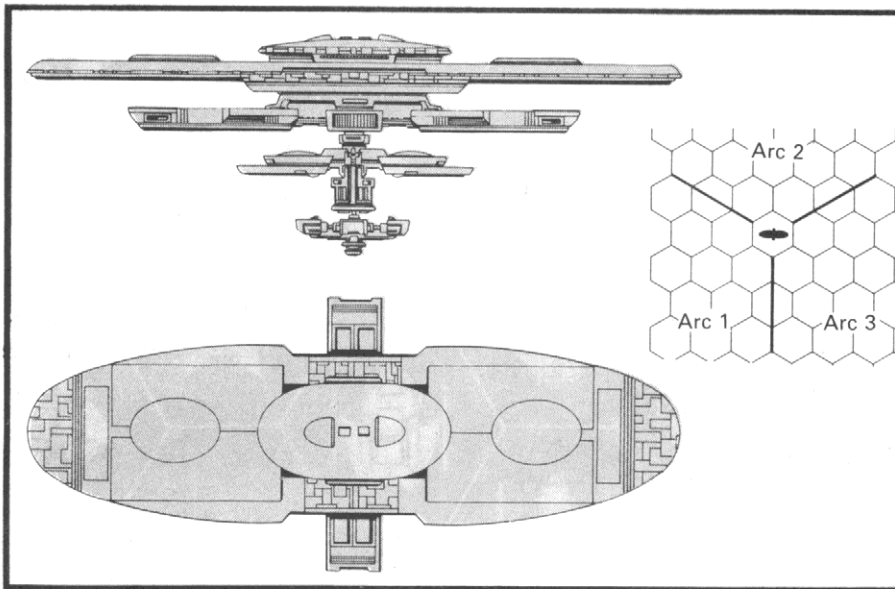

Notes:

Known Sphere Of Operation: Borders

Data Reliability: B

Major Data Source: Border patrol reports; Triangle Sector Intelligence

Soon after the signing of the treaties that ended the Romulan/UFP War, the Romulan High Command began to establish border outposts along the Neutral Zone to insure that no vessels entered Romulan space.

From the outset, it was obvious that these stations would have to be built on location. This meant that construction, maintenance, and quartering facilities would have to be established at the same time. Construction completed, these facilities were left in place to create a broader and more self-sustaining base from which to work. Because of this, a Romulan outpost resembles a spaceborn city, with its many structures and high levels of traffic.

The officers and crew of these outposts are the best the empire has to offer. They support several outlying listening posts and a small detachment of warships. The outposts bordering the Triangle and the Neutral Zone support entire fleets.

On Stardate 1/8008, the first of 80 such outposts was made operational at 8.2S 7.3E, anchoring the arc of the Neutral Zone. From the first, it was capable of gathering intelligence and monitoring ship movements well past the boundaries of the Zone itself, as well as throughout the Imperial Klingon States inside the Triangle.

The commissioning of the Type 6 on Stardate 2 1609 signalled a new era. This station, located at 12.6S 7.5E at the sensitive spinward tip of the Triangle, was powered by the new RMAPG-4 engine, which boasted an increase in power of 67%, and used the RIPG-2 instead of the older RIPG-1. The weaponry was improved by upgrading the disruptors and by adding the new RPL-3 plasma weapons. The shielding was upgraded and the superstructure strength was increased by 40%.

Beginning Stardate 2 2007, the four outposts bordering the Triangle were refitted. Known as the Type 7, they also have improved shielding and an increased superstructure. Refit of all Type 1s and type 3s is projected to be completed by Stardate 2/2606.

The class is named from the Romulan *vas'calanam* (territory of birds).

See attached diagram for firing arcs.

X-3 (Aviary) BORDER DEFENSE OUTPOST

Construction Data:	Type 1	Type 3	Type 6	Type 7
<i>Model Numbers —</i>	1/80	1/99	2/16	2/20
<i>Date Entering Service —</i>	80	88	26	4
<i>Approx. Number Constructed —</i>				
Hull Data:				
<i>Superstructure Points —</i>	30	41	58	70
<i>Damage Chart —</i>	C	C	C	C
<i>Size</i>				
Length —	498 m	498 m	498 m	498 m
Width —	208 m	208 m	208 m	208 m
Height —	152 m	152 m	170 m	170 m
Weight —	800,000 mt	910,000 mt	1,100,000 mt	1,310,000 mt
<i>Storage</i>				
Cargo Units —	600 SCU	600 SCU	600 SCU	600 SCU
Storage Capacity —	30,000 mt	30,000 mt	30,000 mt	30,000 mt
Equipment Data:				
<i>Transporters —</i>				
Standard 9-person	4	4	4	4
Emergency 20-person	2	2	2	2
Cargo	2	2	2	2
<i>Cloaking Device Type —</i>	None	None	None	None
Other Data:				
<i>Crew —</i>	225	240	272	296
<i>Other Personnel —</i>	200	200	240	240
<i>Assigned Shuttlecraft —</i>	10	12	16	16
Generators And Power Data:				
<i>Total Power Units Available —</i>	64	88	144	144
<i>Matter/Antimatter Generator Type —</i>	RMAPG-1	RMAPG-2	RMAPG-4	RMAPG-4
<i>Power Units Available —</i>	48	72	120	120
<i>Impulse Generator Type —</i>	RIPG-1	RIPG-1	RIPG-2	RIPG-2
<i>Power Units Available —</i>	16	16	24	24
Weapons And Firing Data:				
<i>Beam Weapon Type —</i>	RB-3	RB-8	RB-10	RB-11
Number —	12, in 6 banks of 2	12, in 6 banks of 2	12, in 6 banks of 2	12, in 6 banks of 2
Firing Arcs —	4 per arc	4 per arc	4 per arc	4 per arc
Firing Chart —	J	N	U	V
Maximum Power —	6	6	8	9
Damage Modifiers —				
+3	—	(1 - 4)	(1 - 8)	(1 - 10)
+2	(1 - 6)	(5 - 9)	(9 - 16)	(11 - 16)
+1	(7 - 10)	(10 - 13)	(17 - 20)	(17 - 21)
<i>Missile Weapon Type —</i>	None	None	None	RP-3
Number —	—	—	—	9
Firing Arcs —	—	—	—	3 per arc
Firing Chart —	—	—	—	Q
Power To Arm —	—	—	—	10
Damage —	—	—	—	1
<i>Plasma Weapon Type —</i>	None	None	RPL-3	RPL-3
Number —	—	—	3	3
Firing Arcs —	—	—	1 per arc	1 per arc
Firing Chart —	—	—	T	T
Power To Arm —	—	—	8	8
Damage —	—	—	See Chart	See Chart
Shields Data:				
<i>Deflector Shield Type —</i>	RSG	RSJ	RSN	RSO
Shield Point Ratio —	1/1	1/1	1/2	1/3
Maximum Shield Power —	10	13	15	15
Combat Efficiency:				
D-	147.8	207.3	516.3	739.0
WDF-	9.6	49.2	123.9	185.4

*These counters are to be used as playing pieces.
Glue onto cardboard and cut on solid white lines.*

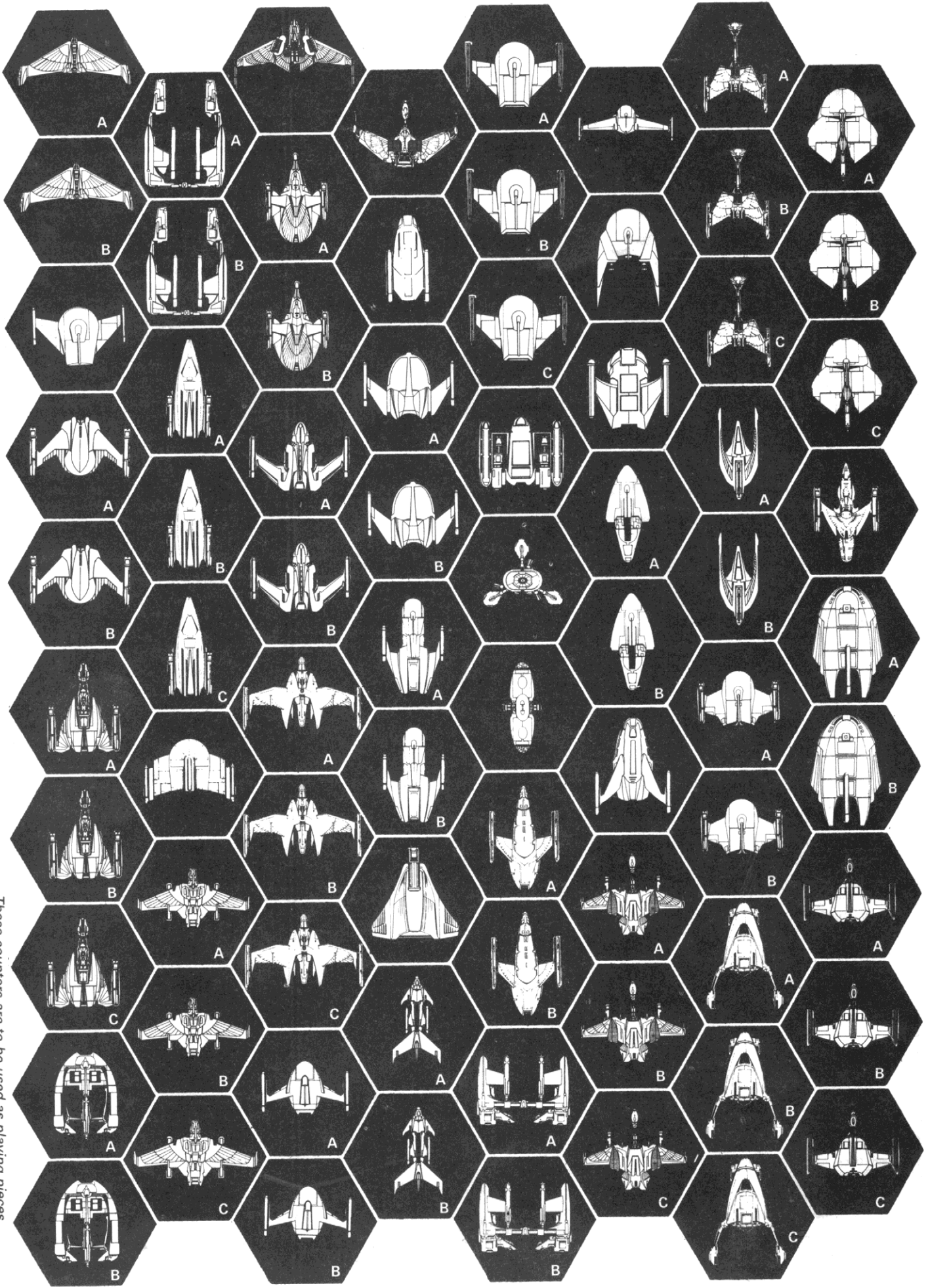

CLASSIFIED AUTHORIZED PERSONNEL ONLY

The Romulan Ship Recognition Manual is intended for Star Fleet personnel with a "need to know" concerning information on the Romulan Star Navy. This comprehensive study discloses, for the first time, all known combat, visual, and historical data on 40 different Romulan ships and their variants. Also included is a chronology of service and silhouette recognition chart. This manual is a must for all *Star Trek* enthusiasts.

Shown on the cover is a cutaway view of the Whitewind cruiser.

