

A supplement for use with
STAR TREK[®]
THE ROLE PLAYING GAME

FEDERATION

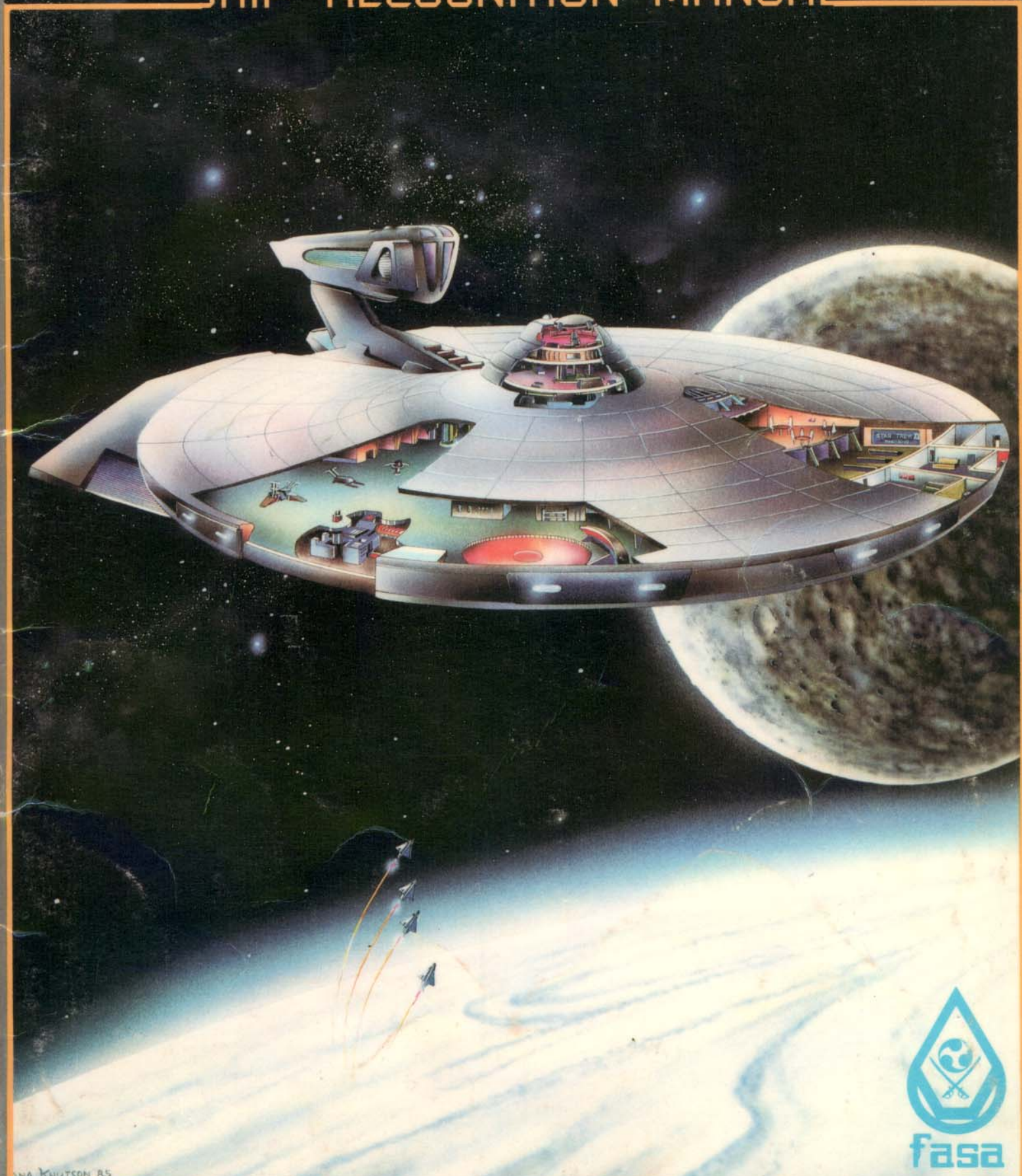

SHIP RECOGNITION MANUAL





CHANGES TO THIS MANUAL

Users of this manual are required to submit changes in the information in this publication pursuant to SFOPS. MAN. 307/A45T. Such changes or other comments regarding this publication must be keyed to the specific page, paragraph, and line of text in which the change is recommended. Reasons should be provided for each comment to insure understanding and complete evaluation.

Comments should be prepared using SFRD Form 2028 (*Recommended Changes to Publication*) and forwarded directly to:

STAR FLEET INTELLIGENCE COMMAND

Assistant Chief of Staff,
Military History Division
Austin, Tx, Terra 01.3

Unauthorized use, possession, or disclosure of the contents of this manual is strictly prohibited. All violations are treasonous acts against the United Federation of Planets. Failure to comply with directives regarding the use of this manual will result in life imprisonment, death or both.

Classified Documents Directive 998.21C

Introduction

THE ROLE OF STAR FLEET

Since its austere beginnings on Stardate 0/8910, Star Fleet has grown into the most powerful military, colonial, and exploratory force in known space. Its purpose is to defend the United Federation of Planets from its known enemies or any would-be invaders, to keep open all trade routes by enforcing the laws governing their use, and to explore, colonize, and develop frontier areas for the betterment of all. To this end, Star Fleet maintains a large and modern navy capable of meeting any challenge.

The following excerpt, from Adm. Josef Cookston's address to the Military Appropriations Committee, Stardate 2/2104, gives a portent of the future:

For more than 130 years, Star Fleet has been tested, re-tested, and never found wanting, but its supreme challenge lies ahead. With the quantitative military balance decidedly adverse and with the former qualitative edge increasingly in doubt, we can assume a favorable outcome in the event of war only by superior concepts, tactics, and leadership. We are desperately in need of a strategy not only for waging war, but for winning without war.

SCOPE OF THIS MANUAL

This manual describes the major ships of Star Fleet on a classified basis, providing an overview to authorized personnel and line officers. An effort has been made to provide a comprehensive and objective presentation despite the limitations of space. It is designed for general reading and quick reference.

A historical background of Star Fleet starships from the period of "The Great Awakening" to the present is provided. Discussions of all major ships include observations on their weaknesses and strengths, and complete combat data is provided for evaluation. The overall reliability of the data provided is subject to the level of classification authorized by Star Fleet Command. More detailed information on the performance characteristics of each vessel may be found in the operations manuals of those particular vessels.

FEDERATION SHIP RECOGNITION MANUAL

INTRODUCTION

The Role Of Star Fleet 1
Scope Of This Manual 1

COMBAT VESSELS

Assault Ships
Makin 3
Continent 3

Battleships
Excelsior 4

Corvettes
Scorpio 5

Cruisers
Andor 6
Anton 7
Constitution 8
Enterprise 10
Reliant 12
Brenton 14
Durrett 14

Cutters
Epsilon 15
Solar 15

Destroyers
Baker 16
Wilkerson 17
Larson 18
Lenthal 20
Thufir 20

Escort
Genser 21
Griffon 22
Remora 22

Frigate
Northampton 23
Chandley 24
Loknar 26
Babcock 28
Kiev 28

Monitors
Fenlon 29

Scouts
Nelson 30
Bader 31
Keith 32
Ranger 32

SUPPORT VESSELS

Transports
Cochrane 33
Kethkin 34
MoKal 35

Freighters
Aakenn 36
Liberty 37

Warpshuttles
Greyhound 38
Pulsar 38

REPAIR VESSELS AND FACILITIES

Tenders
Derf 39
Cle Dan 40

Repair Facilities
Pearl 41

Defense Outposts
Alamo 42

RECOGNITION SILHOUETTES

Pull-out 43

TIME LINES

Pull-out 45



CREDITS

- Design**
 Forest G. Brown
- Writing**
 Forest G. Brown
- Historical Consultant**
 Commander Hikaru Sulu
- Editorial Staff**
Editor-In-Chief
 L. Ross Babcock III
Editing And Additional Writing
 Wm. John Wheeler
Proofreading
 Donna Ippolito
- Illustration**
 Dana Knutson
 Robert Oswald
- Cover Art**
 Dana Knutson
- Production Staff**
Layout And Pasteup
 Dana Knutson
 Todd F. Marsh
 Jane Bigos
Typesetting
 Karen Vander Mey

Makin Class VII Assault Ship

Construction Data:		
Model Numbers —	MK II	
Date Entering Service —	2/1712	
Number Constructed —	68	
Hull Data:		
Superstructure Points —	11	
Damage Chart —	C	
Size		
Length —	180 m	
Width —	95 m	
Height —	35 m	
Weight —	102,200 mt	
Cargo		
Cargo Units —	600 SCU	
Cargo Capacity —	30,000 mt	
Landing Capability —	None	
Equipment Data:		
Control Computer Type —	M-2	
Transporters —		
standard 6 person	4	
combat 20 person	6	
emergency 22 person	2	
cargo - small	4	
large	2	
Other Data:		
Crew —	38	
Troops —	1,800	
Shuttlecraft —	2	
Engines And Power Data:		
Total Power Units Available —	20	
Movement Point Ratio —	3/1	
Warp Engine Type —	FWE-1	
Number —	2	
Power Units Available —	8	
Stress Charts —	GJK	
Maximum Safe Cruising Speed —	Warp 7	
Emergency Speed —	Warp 9	
Impulse Engine Type —	FIB-2	
Power Units Available —	4	
Weapons And Firing Data:		
Beam Weapon Type —	FH-2	
Number —	4	
Firing Arcs —	2Up, 2Ws	
Firing Chart —	H	
Maximum Power —	3	
Damage Modifiers —	(1 - 10)	
+ 1		
Shields Data:		
Deflector Shield Type —	FSD	
Shield Point Ratio —	1/2	
Maximum Shield Power —	7	
Combat Efficiency:		
D —	44.7	
WDF —	5.2	

232.44

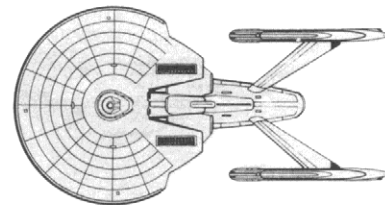
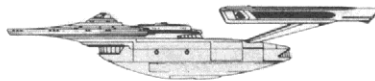

Notes:

The *Makin* Class assault ship can beam down its complement of 1800 marines, 9 heavy tanks and 32 light support vehicles in 25 minutes, slightly less rapidly than the *Continent* Class vessel.

The *Makin* is produced at the Tellar and Salazaar ship-yards, with a combined annual production rate of 14 per year. Of the 68 *Makin* Class ships built, 64 remain in active service, 1 is used by Star Fleet Training Command, 1 has been destroyed, and 1 has been scrapped.

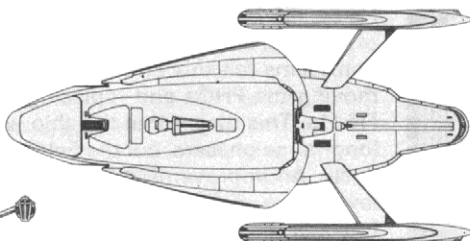
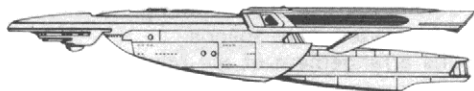

Notes:

A typical *Continent* Class assault ship can beam down its contingent of 3200 marines, 16 heavy tanks, and 50 light support vehicles in 30 minutes, insuring fast response when arriving at a planetary trouble-spot.

The *Continent* is produced at Sol II at a rate of 12 per year. Of the 60 *Continent* Class ships built, 58 remain in active service, 1 is used by Star Fleet Training Command, and 1 has been scrapped.

Continent Class IX Assault Ship

Construction Data:		
Model Numbers —	MK I	
Date Entering Service —	2/1801	
Number Constructed —	60	
Hull Data:		
Superstructure Points —	15	
Damage Chart —	C	
Size		
Length —	245 m	
Width —	175 m	
Height —	45 m	
Weight —	129,900 mt	
Cargo		
Cargo Units —	1,000 SCU	
Cargo Capacity —	50,000 mt	
Landing Capability —	None	
Equipment Data:		
Control Computer Type —	M-3	
Transporters —		
standard 6 person	6	
combat 20 person	8	
emergency 22 person	4	
cargo - small	6	
large	2	
Other Data:		
Crew —	62	
Troops —	3,200	
Shuttlecraft —	6	
Engines And Power Data:		
Total Power Units Available —	40	
Movement Point Ratio —	3/1	
Warp Engine Type —	FWD-2	
Number —	2	
Power Units Available —	18	
Stress Charts —	MKG	
Maximum Safe Cruising Speed —	Warp 5	
Emergency Speed —	Warp 7	
Impulse Engine Type —	FID-2	
Power Units Available —	4	
Weapons And Firing Data:		
Beam Weapon Type —	FH-2	
Number —	6	
Firing Arcs —	2Up, 21, 2Ws	
Firing Chart —	H	
Maximum Power —	3	
Shields Data:		
Deflector Shield Type —	FSD	
Shield Point Ratio —	1/2	
Maximum Shield Power —	6	
Damage Modifiers —	(1 - 10)	
+ 1		
Combat Efficiency:		
D —	68.5	
WDF —	7.8	

Excelsior Class XIII-XIV Battleship

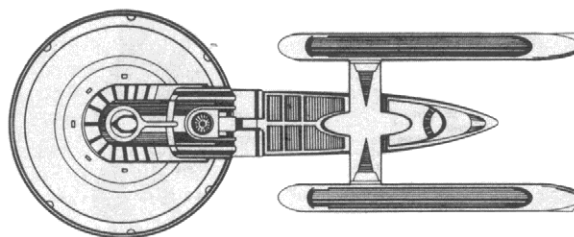
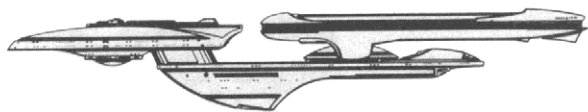

Construction Data:

Model Numbers —	MK I	MK II
Date Entering Service —	2/2210	2/2303
Number Constructed —	1	1

Hull Data:

Superstructure Points —	38	42
Damage Chart —	C	C
Size		
Length	467 m	467 m
Width —	186 m	186 m
Height —	78 m	78 m
Weight —	239,930 mt	243,610
Cargo		
Cargo Units —	550 SCU	550 SCU
Cargo Capacity —	27,500 mt	27,500 mt
Landing Capability —	None	None

Equipment Data:

Control Computer Type —	M-8	M-8
Transporters —		
standard 6-person	6	6
emergency 22-person	6	6
cargo	3	3

Other Data:

Crew —	810	802
Passengers —	40	40
Shuttlecraft —	20	20

Engines And Power Data:

Total Power Units Available —	108	116
Movement Point Ratio —	6/1	6/1
Warp Engine Type —	FTWA	FTWA
Number —	2	2
Power Units Available —	38	38
Stress Charts —	D/F	D/F
Maximum Safe Cruising Speed —	Warp 12	Warp 12
Emergency Speed —	Warp 14	Warp 14
Impulse Engine Type —	FIG-2	FIG-3
Power Units Available —	32	40

Weapons And Firing Data:

Beam Weapon Type —	FH-11	FH-11
Number —	8 in 4 banks	10 in 5 banks
Firing Arcs —	2f, 2f, 2s, 2a	2f/p, 2f, 2f/s, 2p/a, 2s/a
Firing Chart —	Y	Y
Maximum Power —	10	10
Damage Modifiers —		
+3	(1 - 10)	(1 - 10)
+2	(11 - 17)	(11 - 17)
+1	(18 - 24)	(18 - 24)
Beam Weapon Type —	FH-5	
Number —	8 in 4 banks	
Firing Arcs —	4p, 4s	
Firing Chart —	R	
Maximum Power —	4	
Damage Modifiers —		
+2	(1 - 8)	
+1	(9 - 16)	
Missile Weapon Type —	FP-4	FP-4
Number —	4	6
Firing Arcs —	2f, 2a	1f, 2f/p, 2f/s, 1a
Firing Chart —	S	S
Power To Arm —	1	1
Damage —	20	20

Shields Data:

Deflector Shield Type —	FSS	FSS
Shield Point Ratio —	1/4	1/4
Maximum Shield Power —	20	20

Combat Efficiency:

D —	184.3	198
WDF —	160.4	182

Notes:

On Stardate 2/2210, the first of the new battleships, the *USS Excelsior*, was commissioned. This vessel is the newest in Star Fleet, and it incorporates many experimental operating systems. Since that time, Star Fleet has announced that another Mk I has been built, the *USS Proxima*, which is expected to finish its trials sometime in early 2/2400, and will be commissioned immediately thereafter.

Star Fleet Command has contracted for two Mk II versions to be built. The first of those, the *USS Columbia*, will be completed and ready for trials in early 2/2400 while the second, the *USS Galacta*, is expected to begin its trials sometime in the latter part of the year.

All the battleships are being constructed at the Sol III and Sol IV shipyards.

Technical data regarding the TransWarp engines used on these ships is classified and is not available for publication at this time. These engines operate by capturing the warp envelope in a transporter field and beaming it ahead of the ship to attain the reported warp speeds.

The weapons arrangement of the Mk I consists of 16 phasers and 4 photon torpedoes. Mounting 8 FH-11s and 8 FH-5s, the Mk Is originally were designed to cover all fields of fire with both long- and short-range phasers. The evaluation teams felt this arrangement could be improved by removing the FH-5s and replacing them with two additional FH-11s. This meant that the ship would carry only 10 of the long-range phasers, but the fields of fire overlap more effectively. An improvement in torpedo launcher technology allowed two more torpedo bays to be added. The torpedo tubes of the Mk I bear only to the fore and aft, but those of the Mk II are arranged to cover all firing arcs.

The shield system of the *Excelsior* Class vessels is reportedly an improved version of the quadri-transducer that delivers more deflector power. Like the engines, the technical data regarding the shield system is classified.

The *Excelsior* has been called "The Great Experiment" by many in influential circles. These ships are the newest of any in Star Fleet and incorporate experimental technology in most of the components required to operate a warship. With so many new systems aboard these vessels, the process of testing them has been slow. Prior to being installed, each component was tested and re-tested until it met standards. Nevertheless, when the *USS Excelsior* was taken out for trials, the evaluation teams were constantly faced with primary system malfunctions that would not allow any of the secondary or back-up systems to be tested. This caused the evaluators to deal with these new components on a one-at-a-time basis, and thus creating time delays in the commissioning of the class.

Scorpio Class II Corvette

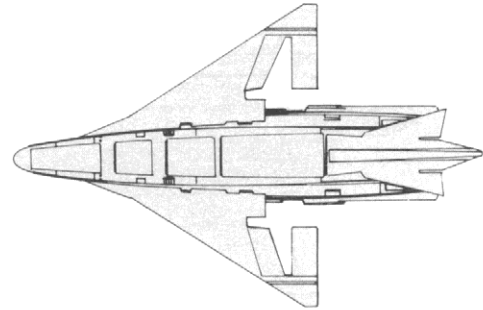
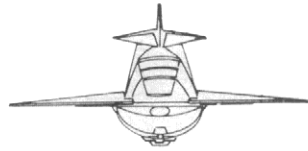
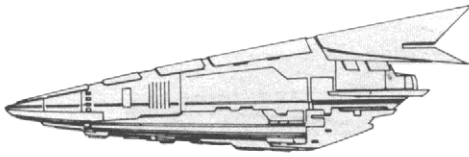

Construction Data:

Model Numbers —	MK I
Date Entering Service —	2/2206
Number Constructed —	192

Hull Data:

Superstructure Points —	3
Damage Chart —	C
Size	
Length —	22 m
Width —	7 m
Height —	7 m
Weight —	7,840 mt

Cargo

Cargo Units —	1 SCU
Cargo Capacity —	50 mt
Landing Capability —	Yes

Equipment Data:

Control Computer Type —	L-13
Transporters —	
standard 6-person	1

Other Data:

Crew —	4
--------	---

Engines And Power Data:

Total Power Units Available —	7
Movement Point Ratio —	1/3
Warp Engine Type —	FWA-1
Number —	1
Power Units Available —	6
Stress Charts —	F/G
Maximum Safe Cruising Speed —	Warp 7
Emergency Speed —	Warp 9
Impulse Engine Type —	FIA-1
Power Units Available —	1

Weapons And Firing Data:

Beam Weapon Type —	FH-1
Number —	2 in 1 bank
Firing Arcs —	1/4/4
Firing Chart —	F
Maximum Power —	2
Missile Weapon Type —	FP-3
Number —	1
Firing Arcs —	1
Firing Chart —	D
Power To Arm —	1
Damage —	6

Shields Data:

Deflector Shield Type —	FSB
Shield Point Ratio —	1/2
Maximum Shield Power —	11

Combat Efficiency:

D —	81.2
WDF —	2.2

175-6

Notes:

The *Scorpio* Class corvettes have been commissioned to supplement Star Fleet's monitors, most of which are restricted to in-system or near-base patrols because of their sub-light engines. The *Scorpio* Class is lightweight and warp-capable, thus extending the defensive range of the bases or systems that require protection. These small ships are expected to improve the overall defensive posture of the UFP by allowing capital ships to operate for longer periods in sensitive areas.

The corvettes are organized into groups consisting of 12 ships operating in 3 flights of 4 ships each. At the present time, there are 15 operational groups with plans for an additional 45. The operational groups are assigned as follows: The 1st, 2nd and 5th Pursuit Groups at Starbase 10; the 3rd, 6th and 7th Pursuit Groups at Starbase 12; the 4th, 8th, and 9th Pursuit Groups at Starbase 20; the 1st Andorian, 10th, and 11th Pursuit Groups at Starbase 27; the 2nd Andorian, and 12th Pursuit Groups at Starbase 15; and the 13th Pursuit Group at Starbase 14.

Though the original design for the *Scorpio* came from Andorian contractors, construction contracts were awarded to the shipyards at Morena and Salazaar, the latter being an Andorian-operated facility. Like so many Andorian designs, these vessels are made to close quickly with their enemies and deal crippling or fatal blows. The highly efficient FWA-1 warp engines allow the corvettes to rapidly surround an enemy vessel, causing it to divert power to an all-around defense, and therefore, weakening its offensive capability.

These ships carry only two FH-1 phasers and one FP-3 photon torpedo, but they are considered to have sufficient offensive power to deter pirates, smugglers, and small enemy warships from operating in their patrol areas.

The Morena and Salazaar shipyards are currently producing approximately 180 *Scorpio* Class corvettes per year. Of the 192 ships built, 180 remain in active service, and 12 are assigned to Star Fleet Training Command.

Andor Class IX Cruiser

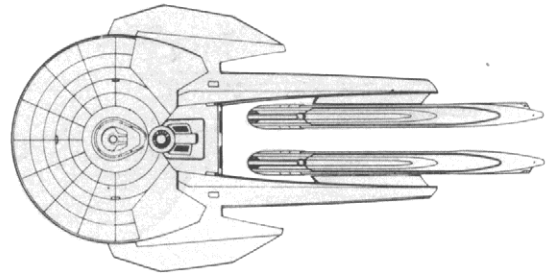
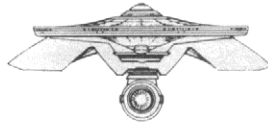
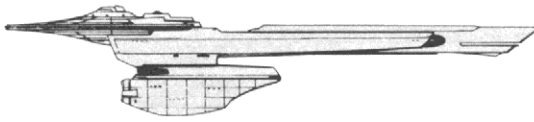

Construction Data:

Model Numbers —	MK II
Date Entering Service —	2/1806
Number Constructed —	140

Hull Data:

Superstructure Points —	22
Damage Chart —	C
Size	
Length —	260 m
Width —	130 m
Height —	60 m
Weight —	121,600 mt

Cargo

Cargo Units —	300 SCU
Cargo Capacity —	15,000 mt
Landing Capability —	None

Equipment Data:

Control Computer Type —	M-3
Transporters —	
standard 6-person	6
emergency 22-person	3
cargo - small	2
large	1

Other Data:

Crew —	240
Passengers —	40
Shuttlecraft —	6

Engines And Power Data:

Total Power Units Available —	42
Movement Point Ratio —	3/1
Warp Engine Type —	FWE-2
Number —	2
Power Units Available —	13
Stress Charts —	G/K
Maximum Safe Cruising Speed —	Warp 7
Emergency Speed —	Warp 9
Impulse Engine Type —	FIF-2
Power Units Available —	16

Weapons And Firing Data:

Beam Weapon Type —	FH-3
Number —	2 in 1 bank
Firing Arcs —	2f
Firing Chart —	T
Maximum Power —	8
Damage Modifiers —	
+3	(1 - 5)
+2	(6 - 12)
+1	(13 - 18)

Missile Weapon Type —

Number —	8
Firing Arcs —	1p, 4f, 1s, 2a
Firing Chart —	R
Power To Arm —	1
Damage —	8

Shields Data:

Deflector Shield Type —	FSL
Shield Point Ratio —	1/3
Maximum Shield Power —	15

Combat Efficiency:

D —	112.5
WDF —	51.4

5782-5

Notes:

The *Andor* Class is the only operational missile cruiser in Star Fleet. These unique vessels have gained the respect and admiration of their crews because of their handling characteristics and offensive capabilities. The overall design came from Andorian design teams contracted to create a cruiser with photon torpedoes as its main weapons. These ships have so captured the heart and spirit of the Andorians that the majority are crewed solely by them. All have been named for Andorian military leaders. The *Andor* Class forms the core of all squadrons in the famed 'Blue Fleet', and is an integral part of front line forces for Star Fleet.

Like the *Thufir* Class destroyer, the warp engines are mounted close together and center aft of the main hull. This affords the engines more protection during battle because of the partial cover provided by the secondary hull. As with all Star Fleet vessels, the engines can be jettisoned in case of an overload in the matter/anti-matter chamber.

The most unusual feature of this vessel is the weapons array. Mounting two FH-13 phasers and 8 FP-7 photon torpedoes, it well deserves its informal name of 'missile boat'. *Andor* Class vessels are capable of engaging the enemy at 180,000 km with their phasers, and 16,000 km with their torpedoes. Due to the number of torpedoes and the ranges at which they are most effective, these vessels normally operate in combat at 120,000 km. The *Andor* Class has been encountered and engaged by both Romulan and Klingon forces, which were taken by surprise when the Star Fleet vessel fired a spread of torpedoes whose number was unexpected. In each case, the enemy withdrew from the field of battle before the cruiser could be fully put to the test.

The *Andor* Class cruiser is manufactured at the Andor and Salazaar shipyards at a combined rate of 28 per year. Of the 140 *Andors* built, 138 remain in active service. Two have been scrapped after a high-speed collision that resulted in irreparable damage.

Anton Class X Cruiser

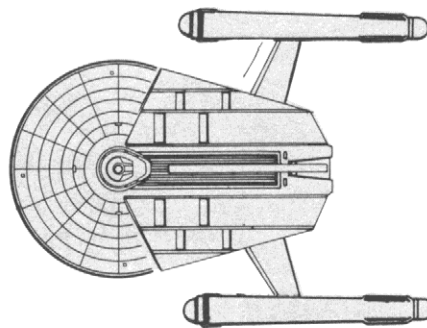
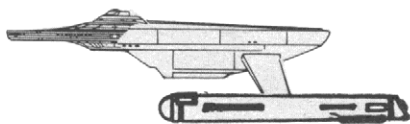

Construction Data:

Model Numbers —	MK I	MK II	MK IV
Date Entering Service —	1/8704-2/1002	1/9702-2/1410	2/1210
Number Constructed —	68	56	12

Hull Data:

Superstructure Points —	16	18	18
Damage Chart —	C	C	C
Size			
Length —	224 m	226 m	226 m
Width —	145 m	145 m	145 m
Height —	51 m	51 m	51 m
Weight —	147,800 mt	150,000 mt	149,200 mt

Cargo

Cargo Units —	300 SCU	300 SCU	300 SCU
Cargo Capacity —	15,000 mt	15,000 mt	15,000 mt
Landing Capability —	None	None	None

Equipment Data:

Control Computer Type —	M-3	M-4	M-4
Transporters —			
standard 6-person	4	4	4
emergency 22-person cargo	2	3	3
	2	2	2

Other Data:

Crew —	290	295	306
Passengers —	40	40	40
Shuttlecraft —	4	4	4

Engines And Power Data:

Total Power Units Available —	35	38	46
Movement Point Ratio —	3/1	3/1	4/1
Warp Engine Type —	FWC-1	FWC-1	FWC-2
Number —	2	2	2
Power Units Available —	16	16	20
Stress Charts —	O/M	O/M	N/M
Maximum Safe Cruising Speed —	Warp 7	Warp 7	Warp 6
Emergency Speed —	Warp 9	Warp 9	Warp 8
Impulse Engine Type —	FIC-2	FIC-3	FIC-3
Power Units Available —	3	6	6

Weapons And Firing Data:

Beam Weapon Type —	FL-5	FH-3	FH-10
Number —	4 in 2 banks	4 in 2 banks	4 in 2 banks
Firing Arcs —	2fp, 21/s	2fp, 21/s	2fp, 21/s
Firing Chart —	H	W	W
Maximum Power —	2	5	7
Damage Modifiers —			
+3		(1 - 10)	(1 - 10)
+2	(1 - 4)	(11 - 17)	(11 - 17)
+1	(5 - 7)	(18 - 20)	(18 - 20)

Shields Data:

Deflector Shield Type —	FSG	FSH	FSH
Shield Point Ratio —	1/1	1/2	1/2
Maximum Shield Power —	9	11	11

Combat Efficiency:

D —	52.9	78.7	76.7
WDF —	4.4	23.2	38.8

232 1825-8 2975-96



Notes:

First commissioned on Stardate 1/8704 during the period known as "The Great Awakening", the *Anton* Class cruiser was in the forefront of that expansion effort. At the time, Star Fleet itself was expanding in response to the changing and expanding economic and political goals of the UFP. To meet the demand of a larger navy, the Military Appropriations Committee authorized the development and testing of hundreds of vessel types, the *Anton* among them.

During this same period, the concepts of ship design were rapidly evolving and becoming more sophisticated, and the technology to build and operate starships was going through an industrial revolution. Advances in all facets of the technology required to construct, maintain, and operate a starship was changing so rapidly that some ships were obsolete before they were completed. The *Anton* design was changed no fewer than 12 times before the tooling and machining was begun. Even so, the ship required some alterations during its trials and was to see many more changes after its commissioning, the last of which was the refitting to the *Reliant* Class.

When these new cruisers were launched, they were only capable of performing 3-year missions with re-supply at 1-year intervals. This made their dual-purpose role of research cruiser harder to perform. With the great distances that had to be travelled, they could not get more than 6-months travel time from a friendly outpost. This meant they could only advance as fast as the frontier was expanding.

Constitution Class XI Cruiser

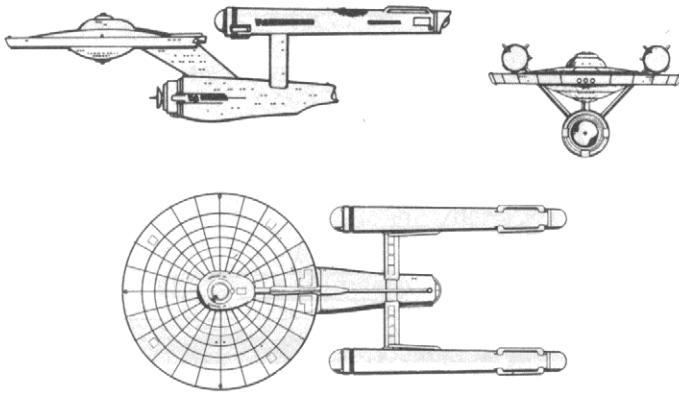

Construction Data:

Model Numbers —	MK I	MK II	MK III
Date Entering Service —	1/8801-2/1210	2/0206	2/1202
Number Constructed —	13	28	6

Hull Data:

Superstructure Points —	20	20	22
Damage Chart —	C	C	C
Size			
Length —	290 m	290 m	295 m
Width —	127 m	127 m	127 m
Height —	73 m	73 m	73 m
Weight —	162,425 mt	164,600 mt	167,900 mt
Cargo			
Cargo Units —	380 SCU	390 SCU	390 SCU
Cargo Capacity —	19,000 mt	19,500 mt	19,500 mt
Landing Capability —	None	None	None

Equipment Data:

Control Computer Type —	M-3	M-4	M-4
Transporters —			
standard 6-person	4	4	4
emergency 22-person cargo	5	5	5
	2	2	2

Other Data:

Crew —	410	430	430
Passengers —	80	60	60
Shuttlecraft —	10	12	12

Engines And Power Data:

Total Power Units Available —	36	44	48
Movement Point Ratio —	4/1	4/1	4/1
Warp Engine Type —	FWC-1	FWF-1	FWF-1
Number —	2	2	2
Power Units Available —	16	20	20
Stress Charts —	O/M	G/L	G/L
Maximum Safe Cruising Speed —	Warp 6	Warp 6	Warp 6
Emergency Speed —	Warp 8	Warp 8	Warp 8
Impulse Engine Type —	FIB-2	FID-2	FIE-2
Power Units Available —	4	4	8

Weapons And Firing Data:

Beam Weapon Type —	FL-6	FH-3	FH-3
Number —	6 in 3 banks	6 in 3 banks	6 in 3 banks
Firing Arcs —	2/p, 2f, 2/s	2/p, 2f, 2/s	2/p, 2f, 2/s
Firing Chart —	H	W	W
Maximum Power —	3	5	5
Damage Modifiers —			
+3		(1 - 10)	(1 - 10)
+2	(1 - 4)	(11 - 17)	(11 - 17)
+1	(5 - 7)	(18 - 20)	(18 - 20)
Missile Weapon Type —	FAC-3	FP-1	FP-5
Number —	2	2	2
Firing Arcs —	f	f	f
Firing Chart —	H	L	R
Power To Arm —	4	1	1
Damage —	12	10	16

Shields Data:

Deflector Shield Type —	FSG	FSN	FSO
Shield Point Ratio —	1/1	1/2	1/3
Maximum Shield Power —	9	16	16

Combat Efficiency:

D —	64.6	83.6	97.5
WDF —	12.4	43.6	53.8

801 04 12.4 9.5 43.6



Notes:

The *Constitution* Class cruisers are the most renowned vessels of their time. Serving as both a research vessel and a cruiser, these ships have performed their duties to perfection for the last 35 years. The *Constitution* Class ships were an integral part of the buildup during "The Great Awakening," from the outset the most versatile of all ships built for the expansion efforts.

The original construction contract called for 13 vessels to be built that would serve as cruisers, have complete research facilities, and be capable of operating on 5-year research and exploration missions. On Stardate 1/8801, the first of these vessels, the *USS Constitution*, was commissioned, followed by one more each month for five months. As soon as these vessels were completed and commissioned, they were sent on 2-year shakedown cruises. Over the next five years, the remaining 7 cruisers were built. The construction program came to a halt with the commissioning of the *USS Defiant*.

When the Four Years War broke out, Star Fleet decided to produce warships instead of the dual-purpose cruisers that devoted large areas of their space to research and laboratories. Even though the *Constitution* Class was not put into production for the war effort, four of the ships saw action. Each distinguished itself in battle time and again, soon gaining the nickname "The Queens Of Star Fleet". After-action reports continued to show the combat ability of this ship to be superior to any other ship in the fleets, and so the decision to produce more of them was finally issued on Stardate 1/9611.

The ship that would be produced was the Mk II version, mounting the new phaser weaponry and newer, more powerful shields. Because of these modifications to the original design, construction did not begin until Stardate 1/9709, and the first ship did not come off the line until 1/9901, 7 months after the end of the war. Star Fleet decided to continue the production of the *Constitution* Class cruisers and expanded the total number to 42 vessels.

On Stardate 2/0104, the FWF-1 warp drive engine was brought into the inventory, and all *Constitution* Class ships were recalled to be refit as Mk IIIs. By Stardate 2/0510, the refitting was complete and the *Constitution* Class remained the most advanced starship of its time. One Mk III, the *USS Ark Royal*, still serves in Star Fleet, exploring the rimward areas and acting as ongoing proof of this class' successful record.

After the first successful test firing of the FP-5 photon torpedo, Star Fleet ordered that 12 *Constitution* Class ships be modified to fire it. On Stardate 2/1202, the *USS Discovery*, *USS Saratoga*, *USS El Dorado*, and *USS Kitty Hawk* were sent into service as Mk IVs, mounting not only the new torpedo system, but also more powerful impulse engine and shield generators.

The Mk IV was the last version of the *Constitution* Class to be built, but not the last to use that particular hull style. The *Enterprise* Class cruiser was originally built from older *Constitution* hulls and retains its general appearance. *Constitution* Class ships were constructed at the Sol IV shipyards.

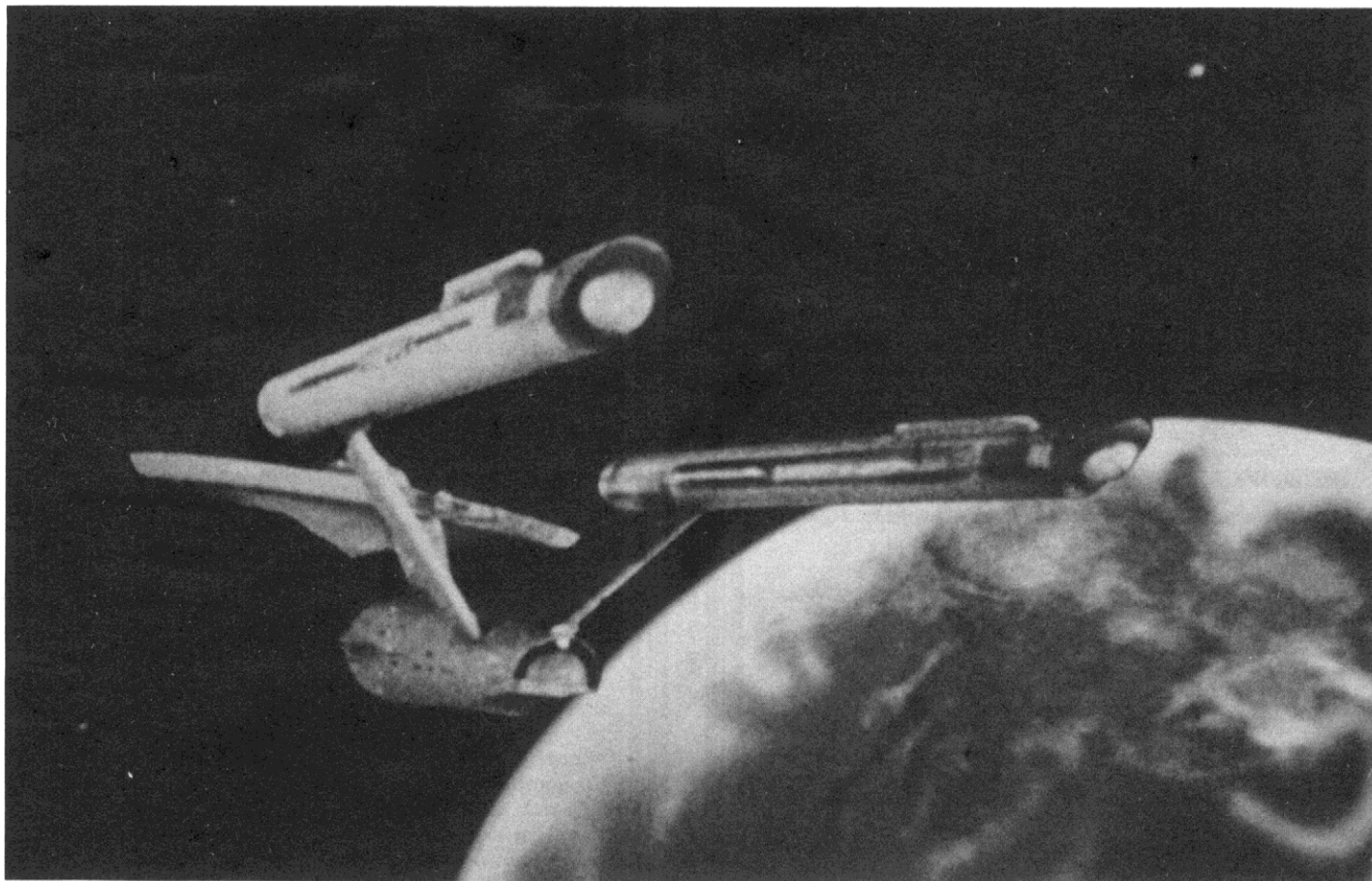

Disposition:

The following list of *Constitution* Class cruisers shows their hull numbers, name, model designation, date entering service, and current disposition. The disposition is represented by the letter codes given below and is followed by the date of occurrence, if known.

- I Inactive Reserve fleet
- D Destroyed by hostile action or natural disaster
- Sc Scrapped
- L Lost, whereabouts unknown
- R3 Refit to Mk III
- R4 Refit to Mk IV
- RE Refit to *Enterprise* Class
- * Original 13

NCC 1017*	<i>Constellation</i>	I	1/8803, R3 2/0211, D 2/0802	NCC 1715	<i>Challenger</i>	II	2/0008, R3 2/0508, RE 2/1707
NCC 1373*	<i>Republic</i>	I	1/8805, R3 2/0309, L 2/0801	NCC 1717*	<i>Yorktown</i>	I	1/9005, R3 2/0308, Sc 2/1102
NCC 1631*	<i>Intrepid</i>	I	1/8804, R3 2/0206, D 2/0812	NCC 1718	<i>Valiant</i>	II	2/0010, R3 2/0312, RE 2/1802
NCC 1647*	<i>Farragut</i>	I	1/8806, R3 2/0501, D 2/0904	NCC 1719	<i>Essex</i>	II	2/0104, R3 2/0209, RE 2/1803
NCC 1664*	<i>Excalibur</i>	I	1/8901, R3 2/0402, D 2/0905	NCC 1720	<i>Saratoga</i>	II	2/0105, R3 2/0410, R4 2/1202, 12/2006
NCC 1672*	<i>Exeter</i>	I	1/9003, R3 2/0307, Sc 2/1012	NCC 1724	<i>El Dorado</i>	II	2/0109, R3 2/0212, R4 2/1202, 12/2006
NCC 1700*	<i>Constitution</i>	I	1/8801, R3 2/0206, 12/1205	NCC 1725	<i>Kent</i>	II	2/0202, R3 2/0501, R4 2/1212
NCC 1701*	<i>Enterprise</i>	I	1/8802, R3 2/0203, RE 2/1704, D 2/2206	NCC 1727	<i>Littorio</i>	III	2/0912, R4 2/1308
NCC 1702*	<i>Potemkin</i>	I	1/9206, R3 2/0410, D 2/1201	NCC 1736	<i>Ticonderoga</i>	III	2/0308, Sc 2/2204
NCC 1703*	<i>Hood</i>	I	1/9307, R3 2/0402, Sc 2/1201	NCC 1738	<i>Eagle</i>	III	2/0405, Sc 2/2006
NCC 1704	<i>Bismark</i>	II	1/9901, R3 2/0510, RE 2/1709	NCC 1742	<i>Santissima Trinidad</i>	III	2/0606, RE 2/1902
NCC 1705	<i>Yamato</i>	II	1/9903, R3 2/0311, RE 2/1711	NCC 1744	<i>Marseille</i>	III	2/0410, RE 2/1902
NCC 1709*	<i>Lexington</i>	I	1/8912, R3 2/0304, L 2/0702	NCC 1749	<i>Langley</i>	III	2/0503, R4 2/1308
NCC 1710	<i>Kongo</i>	II	1/9909, R3 2/0406, D 2/1803	NCC 1750	<i>Richelieu</i>	III	2/0702, R4 2/1303
				NCC 1751	<i>Forrestal</i>	III	2/0702, R4 2/1205, Sc 2/2111
				NCC 1754	<i>Kitty Hawk</i>	III	2/0801, R4 2/1202, D 2/2209
				NCC 1759	<i>Chikuma</i>	III	2/0804 Sc 2/2301
				NCC 1760	<i>Victory</i>	III	2/0805, L 2/1903
				NCC 1764	<i>Defiant</i>	I	1/9311, R3 2/0303, D 2/0910
				NCC 1765	<i>Rivoli</i>	III	2/0808, D 2/1510
				NCC 1776	<i>BonHomme Richard</i>	III	2/0809, RE 2/1810
				NCC 1777	<i>Endeavor</i>	III	2/0901, R4 2/1211
				NCC 1778	<i>Hornet</i>	III	2/0901, R4 2/1306
				NCC 1779	<i>Akagi</i>	III	2/0905, D 2/1709
				NCC 1780	<i>Kaga</i>	III	2/0905, L 2/1709
				NCC 1791	<i>Ark Royal</i>	III	2/1001
				NCC 1792	<i>Radetsky</i>	III	2/1004, R4 2/1204, D 2/1906
				NCC 1798	<i>Discovery</i>	III	2/1010, R4 2/1202

Enterprise Class XI Cruiser

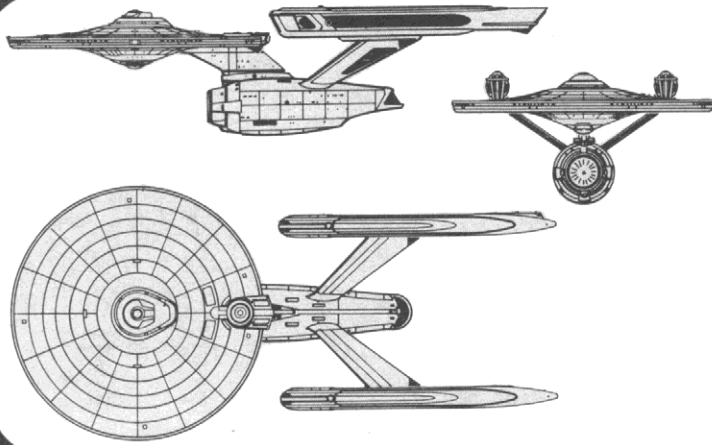

Construction Data:

Model Numbers —	MK I	MK II	MK III
Date Entering Service —	2/1704	2/1910	2/2102
Number Constructed —	26	19	10

Hull Data:

Superstructure Points —	26	27	28
Damage Chart —	C	C	C
Size			
Length —	302 m	302 m	302 m
Width —	131 m	131 m	131 m
Height —	74 m	74 m	74 m
Weight —	160,275 mt	163,275 mt	171,008 mt
Cargo			
Cargo Units —	450 SCU	450 SCU	450 SCU
Cargo Capacity —	22,500 mt	22,500 mt	22,500 mt
Landing Capability —	None	None	None

Equipment Data:

Control Computer Type —	M-6	M-6	M-6A
Transporters —			
standard 6-person	4	4	4
emergency 22-person cargo	4	4	4
	2	2	2

Other Data:

Crew —	412	416	416
Passengers —	60	60	60
Shuttlecraft —	12	12	12

Engines And Power Data:

Total Power Units Available —	60	64	68
Movement Point Ratio —	4/1	4/1	4/1
Warp Engine Type —	FWG-1	FWG-1	FWG-1
Number —	2	2	2
Power Units Available —	26	26	26
Stress Charts —	D/F	D/F	D/F
Maximum Safe Cruising Speed —	Warp 8	Warp 8	Warp 8
Emergency Speed —	Warp 10	Warp 10	Warp 10
Impulse Engine Type —	FIE-2	FIF-1	FIF-2
Power Units Available —	8	12	16

Weapons And Firing Data:

Beam Weapon Type —	FH-11	FH-11	FH-11
Number —	6 in 3 banks	6 in 3 banks	8 in 4 banks
Firing Arcs —	2f/p, 2f, 2f/s	2f/p, 2f, 2f/s	2f/p, 2f, 2f/s, 2a
Firing Chart —	Y	Y	Y
Maximum Power —	10	10	10
Damage Modifiers —			
+3	(1 - 10)	(1 - 10)	(1 - 10)
+2	(11 - 17)	(11 - 17)	(11 - 17)
+1	(18 - 24)	(18 - 24)	(18 - 24)
Missile Weapon Type —	FP-4	FP-4	FP-4
Number —	2	2	3
Firing Arcs —	f	f	2f, 1a
Firing Chart —	S	S	S
Power To Arm —	1	1	1
Damage —	20	20	20

Shields Data:

Deflector Shield Type —	FSP	FSP	FSP
Shield Point Ratio —	1/4	1/4	1/4
Maximum Shield Power —	16	16	16

Combat Efficiency:

D —	145.2	152	162.8
WDF —	89.2	89.2	123.1

1295-9 1328 4 200-07



Notes:

On Stardate 2/1204, the *Constitution Class* cruiser *Enterprise* returned from its last 5-year mission, the only one of the original 13 remaining in service, all others having been lost or destroyed. She was publicly hailed as the Champion Of The Federation, and, on Stardate 2/1302, the vessel began a scheduled overhaul that would lead to one of the most interesting conversion/modifications in recent history. What began as a scheduled overhaul of a *Constitution Class* cruiser turned into the *Enterprise Class* cruiser.

While in drydock for upgrade to the Mk IV version of the *Constitution Class*, the Chief of Engineering, Commander Montgomery Scott, proposed that the vessel be fitted with FWG-1 warp engines, which would give the ship 33% more operating power and would increase its range. The proposal was endorsed, and the vessel was fitted with the newer engines. Once the engines were tested, it was found that the mounts would not withstand the forces exerted by the higher speeds, and so new pylon assemblies were required. A new lower or secondary hull assembly was designed that not only supported the new engines but also incorporated several major changes in appearance.

The secondary hull was enlarged, giving room for larger shuttle bays, larger and more efficiently arranged engineering compartments and work stations, enlarged and improved research facilities, and an enclosed sensor array instead of the older-style extended dish. Furthermore, the photon torpedo bay was placed in the upper forward area. These changes also meant that the primary hull had to be replaced with a larger dish able to house the new fire-control, life-support, and computer systems. The vessel's final appearance was so drastically changed that Star Fleet Command decided to make it a new class entirely.

The *Enterprise Class* ships are the most powerful in known space. Since their introduction on Stardate 2/1704, they have been the UFP's most effective deterrent to aggression. Their combat abilities are equalled by their capability to perform extensive research duties, and this makes them the most versatile of all vessels in service. Despite the dual capabilities, however, the class is being used more and more in its combat role due to the increased border activities of both the Klingon and Romulan Empires.

Like many ships, the *Enterprise Class* has been modified. The first modification was made to house the FIF-1 impulse drive system, giving the Mk II 7% more operating power. The Mk III, likely to replace both the Mk I and II, mounts the FIF-2 impulse drive system, giving 15% more power than the Mk I and 6% more power than the Mk II. Also incorporated into this design is an additional bank of FH-11 phasers and an additional FP-4 torpedo bay, both systems firing aft, giving the class much needed protection there. These modifications have been ordered on several existing Mk Is and Mk IIs, and they may be required on all vessels of this class in the near future. Only two Mk Is are under construction; both are believed to be undergoing the modifications to Mk III.

The *Enterprise Class* cruisers are produced at the Sol III and Salazaar shipyards at a rate of 4 per year. The number under production varies and should only be used for reference.

Disposition

The following list of *Enterprise* Class cruisers shows their hull numbers, model designation, date entering service, and current disposition. The disposition is represented by the letter codes given below and is followed by the date of occurrence, if known. Ships with names that are immediately followed by *II* are successors to *Constitution* Class vessels listed as missing.

- I Inactive/Reserve fleet
- D Destroyed by hostile action or natural disaster
- Sc Scrapped
- L Lost, whereabouts unknown
- RC Refit from *Constitution* Class
- T Training Command vessel

NCC 1701	Enterprise	I	RC 2/1704, D 2/2206
NCC 1702	Potemkin	I	2/1704, I2/2208
NCC 1703	Hood	I	2/1704
NCC 1704	Bismark	I	RC 2/1708
NCC 1705	Yamato	I	RC 2/1705, T 2/1906
NCC 1706	Constellation	I	2/1711
NCC 1707	Intrepid	I	2/1706
NCC 1708	Farragut	I	2/1802
NCC 1709	Lexington	I	2/1802
NCC 1710	Kongo	III	2/2102
NCC 1711	Excalibur	I	2/1808, Sc 2/2003
NCC 1712	Exeter	I	2/1805
NCC 1715	Challenger	I	RC 2/1707
NCC 1716	Zuiho	II	2/1912
NCC 1717	Yorktown	I	2/1712
NCC 1718	Valiant	I	RC 2/1802
NCC 1719	Essex	I	RC 2/1803
NCC 1720	Saratoga II	III	2/2109
NCC 1721	Kearsarge	III	2/2202
NCC 1724	El Dorado II	III	2/2111
NCC 1726	Graf Zeppelin	II	2/1910
NCC 1730	Soryu	II	2/2006
NCC 1731	Hiryu	II	2/2008

NCC 1732	Valley Forge	I	2/1903
NCC 1733	Oriskany	I	2/1906
NCC 1734	Wasp	I	2/1906
NCC 1735	Hancock	I	2/1910, D 2/2108
NCC 1736	Ticonderoga	III	Incomplete
NCC 1738	Eagle	II	2/2108
NCC 1740	King George V	II	2/2201
NCC 1741	Prince of Wales	II	2/2201
NCC 1742	Santissima Trinidad	II	RC 2/2002
NCC 1743	Franklin	II	2/2006
NCC 1744	Marseille	II	RC 2/2001
NCC 1745	Bunker Hill	III	2/2202
NCC 1751	Forrestal	I	2/2210
NCC 1752	Minsk	I	2/1904
NCC 1753	Republic II	I	2/1904
NCC 1754	Kitty Hawk	III	Incomplete
NCC 1759	Chikuma	III	Incomplete
NCC 1760	Victory II	II	2/2010
NCC 1764	Defiant	I	2/1712
NCC 1765	Rivoli	I	2/1809
NCC 1772	Scharnhorst	II	2/2003
NCC 1773	Gneisenau	II	2/2006
NCC 1774	Emperador	III	2/2109
NCC 1775	Kashima	II	2/2110
NCC 1776	BonHomme Richard	I	RC 2/1810
NCC 1779	Akagi	I	2/1903
NCC 1780	Kaga II	II	2/2008
NCC 1781	Freidland	II	2/2201
NCC 1782	Konigsberg	II	2/2106
NCC 1783	Ukrania	III	2/2206
NCC 1784	Clemenceau	II	2/2301
NCC 1785	Marcello	III	2/2210
NCC 1792	Radetsky	II	2/2104
NCC 1793	Fontana	III	2/2208
NCC 1794	Java	III	2/2212

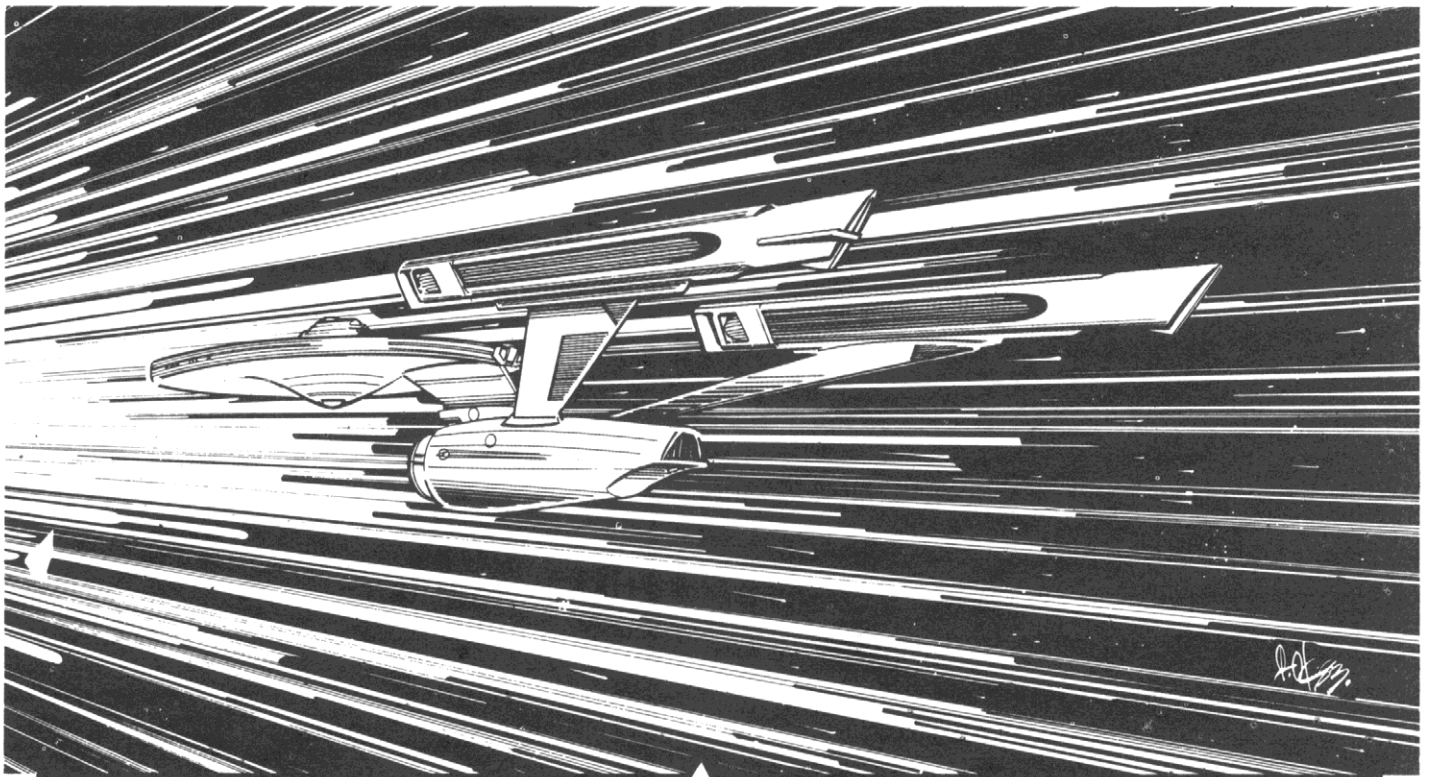

Reliant Class XI Cruiser

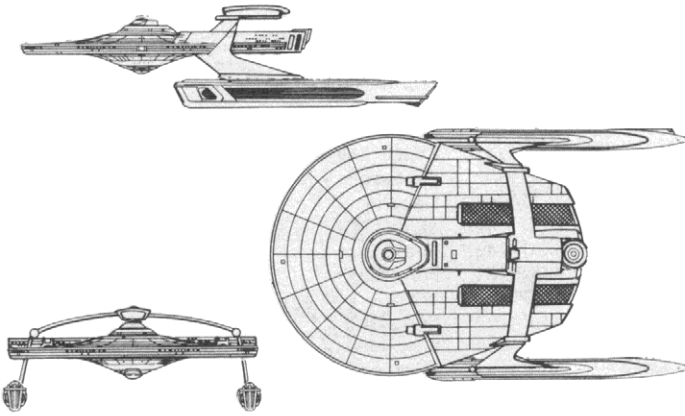

Construction Data:

Model Numbers —	MK I	MK II	MK III
Date Entering Service —	2/1507	2/1802	2/2204
Number Constructed —	52	46	5

Hull Data:

Superstructure Points —	22	24	24
Damage Chart —	C	C	C
Size			
Length —	233 m	233 m	233 m
Width —	140 m	140 m	140 m
Height —	64 m	64 m	64 m
Weight —	165,800 mt	169,600 mt	161,600 mt

Cargo

Cargo Units —	400 SCU	400 SCU	400 SCU
Cargo Capacity —	20,000 mt	20,000 mt	20,000 mt
Landing Capability —	None	None	None

Equipment Data:

Control Computer Type —	M-4	M-4	M-4
Transporters —			
standard 6-person	4	4	4
emergency 22-person cargo	3	3	3
	2	2	2

Other Data:

Crew —	336	346	352
Passengers —	75	75	75
Shuttlecraft —	4	4	4

Engines And Power Data:

Total Power Units Available —	48	52	56
Movement Point Ratio —	4/1	4/1	4/1
Warp Engine Type —			
Number —	2	2	2
Power Units Available —	20	20	22
Stress Charts —	G/L	G/L	H/K
Maximum Safe Cruising Speed —	Warp 6	Warp 6	Warp 8
Emergency Speed —	Warp 8	Warp 8	Warp 9
Impulse Engine Type —			
Number —	8	12	12

Weapons And Firing Data:

Beam Weapon Type —	FH-10	FH-11	FH-11
Number —	4 in 2 banks	4 in 2 banks	4 in 2 banks
Firing Arcs —	2fp, 2fs	2fp, 2fs	2fp, 2fs
Firing Chart —	W	Y	Y
Maximum Power —	7	10	10
Damage Modifiers —			
+3	(1 - 10)	(1 - 10)	(1 - 10)
+2	(11 - 17)	(11 - 17)	(11 - 17)
+1	(18 - 20)	(18 - 24)	(18 - 24)
Missile Weapon Type —			
Number —	2	2	2
Firing Arcs —	1f, 1a	1f, 1a	1f, 1a
Firing Chart —	S	S	S
Power To Arm —	1	1	1
Damage —	20	20	20

Shields Data:

Deflector Shield Type —	FSL	FSL	FSL
Shield Point Ratio —	1/3	1/3	1/3
Maximum Shield Power —	14	14	14

Combat Efficiency:

D —	105	110.8	113.8
WDF —	63.8	67.8	67.8

6699 75122 77156

Notes:

The *Reliant* Class cruiser evolved from the *Anton* Class research cruiser in much the same manner as the *Enterprise* Class cruiser evolved from the *Constitution* Class. On Stardate 2/1410, the *USS Reliant*, an *Anton* Class research cruiser, was brought into the shipyards of Morena for a refit to the Mk IV. As the ship was being dismantled for an engine refit, Star Fleet Command decided to mount the FWF-1 and FIE-2 engine systems instead of the FWC-2 and FIC-3 systems normally used on the Mk IV. This change in both the warp and impulse drive systems created several exterior design changes that prompted Star Fleet to christen this a new class.

During this time, the *Reliant* was further fitted with the 'roll bar' weapons pod, which gave a better field of fire and allowed the addition of photon torpedoes. The *Anton* Class had suffered from lack of intense firepower during the Four Years War, in which 16 *Antons* were destroyed due to their inability to deliver massive blows to their targets. After the war, when public feeling was to disarm instead of rearming, no consideration was given to rearm research ships, but after the Klingon attempt to take Organia, public opinion changed and the problem of the undergunned *Anton* Class resurfaced. In considering the refit and upgrade to more firepower with the emerging *Reliant* Class, the problem of preserving the massive onboard research facilities prompted the 'roll bar' weapons pod. This pod contains the phaser banks mounted on the outer edges, and the fore and aft torpedoes mounted centrally. The major components of the fire control system are also located in the pod, thus giving additional room for personnel and work stations.

The *USS Reliant*, being the first of this type, was made the class vessel. It retained its original hull number, as have all converted models, but newly constructed ships have been given a different series of numbers. Once the decision was made, production of new ships and modifications of existing models was then ordered.

Since they entered service, *Reliant* Class vessels have undergone two changes. The first, upgrading to the Mk II, saw an improved impulse drive system and the changing of the phasers to the FH-11. The second and most recent change, refitting to the Mk III, includes a more powerful set of warp drive engines, which are actually lighter than several of the older styles still in use. All production of Mk I and II models will be halted with the completion of the ships that are already in production, and new *Reliants* will be of the Mk III type.

The *Reliant* Class cruisers are produced at the Morena, Sol IV, and Salazaar shipyards. The rate of production is currently 10 per year.

Disposition:

The following list of *Reliant* Class cruisers shows their hull numbers, name, model designation, date entering service, and current disposition. The disposition is represented by the letter codes given below and is followed by the date of occurrence, if known.

- D Destroyed by hostile action or natural disaster
- Sc Scrapped
- S Disarmed and sold to civil sector
- L Lost, whereabouts unknown
- R1 Refit from *Anton* Class to Mk I
- R2 Refit to Mk II
- R3 Refit to Mk III
- T Training Command vessel

NCC 1863	<i>Repulse</i>	R1 2/1509
NCC 1864	<i>Reliant</i>	R1 2/1507, D 2/2206
NCC 1866	<i>Condor</i>	R1 2/1603
NCC 1869	<i>Gallant</i>	R2 2/1806, R3 2/2205
NCC 1870	<i>Renown</i>	R1 2/1603
NCC 1871	<i>Invincible</i>	R2 2/1904
NCC 1872	<i>Daring</i>	R1 2/1704, T 2/2110
NCC 1873	<i>Devastator</i>	R1 2/1609, R2 2/1907
NCC 1874	<i>Courage</i>	R2 2/1811
NCC 26226	<i>Formidable</i>	I 2/1507
NCC 26227	<i>Defender</i>	I 2/1507, R2 2/2007
NCC 26228	<i>Triumph</i>	I 2/1509, L 2/1706
NCC 26229	<i>Vengeance</i>	I 2/1509
NCC 26230	<i>Venerable</i>	I 2/1508
NCC 25231	<i>Ardent</i>	I 2/1512
NCC 26232	<i>Encounter</i>	I 2/1602, D 2/1902
NCC 26233	<i>Champion</i>	I 2/1604
NCC 26234	<i>Furious</i>	I 2/1604, R2 2/1905
NCC 26235	<i>Ramilles</i>	I 2/1605
NCC 26236	<i>Conqueror</i>	I 2/1605
NCC 26237	<i>Glorious</i>	I 2/1605
NCC 26238	<i>Terror</i>	I 2/1606, S 2/2210
NCC 26239	<i>Valorous</i>	I 2/1607
NCC 26240	<i>Terminator</i>	I 2/1609, R2 2/2101
NCC 26241	<i>Courageous</i>	I 2/1610, R2 2/1904
NCC 26242	<i>Vindicator</i>	I 2/1610
NCC 26243	<i>Redoubt</i>	I 2/1610
NCC 26244	<i>Guardian</i>	I 2/1611, R2 2/1909
NCC 26245	<i>Regulator</i>	I 2/1612, L 2/1712
NCC 26246	<i>Invicta</i>	I 2/1612
NCC 26247	<i>Kings Destroyer</i>	I 2/1701
NCC 26248	<i>Audacious</i>	I 2/1702, R2 2/2102
NCC 26249	<i>Daredevil</i>	I 2/1702
NCC 26250	<i>Striker</i>	I 2/1702
NCC 26251	<i>Enforcer</i>	I 2/1701, R2 2/1812
NCC 26252	<i>Rigorous</i>	I 2/1703
NCC 26253	<i>Blade of Tellar</i>	I 2/1704, R2 2/2003
NCC 26254	<i>Immortal</i>	I 2/1802
NCC 26255	<i>Commencement</i>	I 2/1705
NCC 26256	<i>Accommodator</i>	I 2/1802, Sc 2/2302
NCC 26257	<i>Dominator</i>	I 2/1705
NCC 26258	<i>Lifeforce</i>	I 2/1707, R2 2/1910
NCC 26259	<i>Eradicator</i>	I 2/1706
NCC 26260	<i>Warrior</i>	I 2/1804
NCC 26261	<i>Pugilist</i>	I 2/1807
NCC 26262	<i>Archer</i>	I 2/1803
NCC 26263	<i>Grenadier</i>	I 2/1803
NCC 26264	<i>Fusilier</i>	I 2/1707, D 2/1812
NCC 26265	<i>Reforged</i>	I 2/1902, R2 2/2011
NCC 26266	<i>Brave Shield</i>	I 2/1708
NCC 26267	<i>Legionaire</i>	I 2/1903
NCC 26268	<i>Administrator</i>	I 2/1710, D 2/2002
NCC 26269	<i>Valhalla</i>	I 2/1805
NCC 26270	<i>Forceful</i>	I 2/1901, R2 2/2006
NCC 26271	<i>Redan</i>	I 2/1812
NCC 26272	<i>Perseus</i>	II 2/1802
NCC 26273	<i>Thetis</i>	II 2/1802, R3 2/2209
NCC 26274	<i>Crommalen</i>	II 2/1802

NCC 26275	<i>Amador</i>	II 2/1803
NCC 26276	<i>Circe</i>	II 2/1806
NCC 26277	<i>Achilles</i>	II 2/1803
NCC 26278	<i>Odysseus</i>	II 2/1803, R3 2/2206
NCC 26279	<i>Ra</i>	II 2/1805, D 2/2111
NCC 26280	<i>Odessa</i>	II 2/1806
NCC 26281	<i>Thurgon</i>	II 2/1804
NCC 26282	<i>Athena</i>	II 2/1808
NCC 26283	<i>Hypnos</i>	II 2/1808
NCC 26284	<i>Vesta</i>	II 2/1805
NCC 26285	<i>Hermes</i>	II 2/1806
NCC 26286	<i>Artemis</i>	II 2/1810
NCC 26287	<i>Minerva</i>	II 2/1902
NCC 26288	<i>Bacchus</i>	II 2/1901
NCC 26289	<i>Dionysus</i>	II 2/1812
NCC 26290	<i>Ceres</i>	II 2/1905
NCC 26291	<i>Ares</i>	II 2/1908
NCC 26292	<i>Hestia</i>	II 2/1912
NCC 26293	<i>Asclepius</i>	II 2/1907, R3 2/2204
NCC 26294	<i>Hephaestus</i>	II 2/2001
NCC 26295	<i>Demeter</i>	II 2/2004
NCC 26296	<i>Poseidon</i>	II 2/2010
NCC 26297	<i>Hera</i>	II 2/2003
NCC 26298	<i>Chronos</i>	II 2/2010
NCC 26299	<i>Hathor</i>	II 2/2102
NCC 26300	<i>Isis</i>	II 2/2106, R3 2/2204
NCC 26301	<i>Osiris</i>	II 2/2103
NCC 26302	<i>Thoth</i>	II 2/2107

Historical Notes:

The *USS Triumph* was listed as missing when it failed to make scheduled reports to Galaxy Exploration Command. The official date that the ship was listed as missing was Stardate 2/1706, even though its last report was on 2/1705. The *USS Regulator* was dispatched to search for the missing vessel on Stardate 2/1707. The *Regulator* failed to make its scheduled report on Stardate 2/1712 and was also listed as missing. Both vessels were under the direction of Galaxy Exploration Command and were operating in rimward frontier areas. Subsequent searches have produced no evidence of the whereabouts of these two vessels, and all search activities were called off by Stardate 2/1805.

On Stardate 2/2301, the *USS Accommodator* returned from a 3-year mission into the spinward frontier. Most crewmembers were given leave while the ship was to undergo scheduled maintenance. During the maintenance checks, the *Accommodator* was found to need parts that were not readily available and was therefore removed from its moorings inside the drydock and placed in an exterior mooring. On Stardate 2/2302, the *USS John B. Goodings*, a *Liberty* Class freighter, lost its directional maneuvering control system and rammed the *Accommodator*, causing excessive external damage and internal fires that could not be controlled for several days. The collision completely destroyed the damage control system of the *Accommodator*, and all surviving crewmembers were evacuated. The burning hulk was then towed away from the repair facility and allowed to burn itself out. When the ship was finally boarded by a damage control team, it was found to be totally unserviceable. The vessel was scrapped.

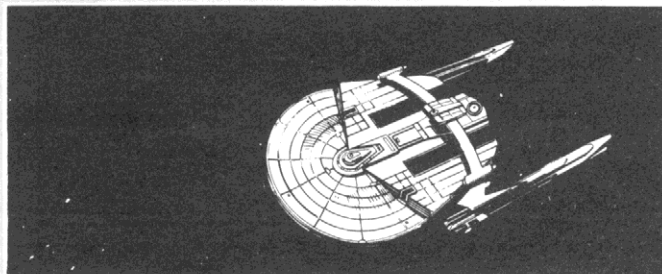

Brenton Class XI Cruiser

Construction Data:

Model Numbers —	MK I	MK III	MK V
Date Entering Service —	2/1404	2/1810	2/2101
Number Constructed —	108	59	18

Hull Data:

Superstructure Points —	21	26	28
Damage Chart —	C	C	C
Size			
Length —	260 m	260 m	275 m
Width —	254 m	254 m	258 m
Height —	55 m	55 m	57 m
Weight —	162,200 mt	173,100 mt	177,300 mt
Cargo			
Cargo Units —	450 SCU	450 SCU	400 SCU
Cargo Capacity —	22,500 mt	22,500 mt	20,000 mt
Landing Capability —	None	None	None

Equipment Data:

Control Computer Type —	M-4	M-4	M-4
Transporters —			
standard 6-person	4	4	4
emergency 22-person	3	3	3
cargo	2	2	2

Other Data:

Crew —	378	386	395
Passengers —	60	60	60
Shuttlecraft —	4	4	4

Engines And Power Data:

Total Power Units Available —	44	44	48
Movement Point Ratio —	4/1	4/1	4/1
Warp Engine Type —	FWF-1	FWF-1	FWF-1
Number —	2	2	2
Power Units Available —	20	20	20
Stress Charts —	G/L	G/L	G/L
Maximum Safe Cruising Speed —	Warp 6	Warp 6	Warp 6
Emergency Speed —	Warp 8	Warp 8	Warp 8
Impulse Engine Type —	FID-2	FID-2	FIE-2
Power Units Available —	4	4	8

Weapons And Firing Data:

Beam Weapon Type —	FH-5	FH-8	FH-8
Number —	6 in 3 banks	6 in 3 banks	8 in 4 banks
Firing Arcs —	2/fp, 2f, 2fs	2/fp, 2f, 2fs	2/fp, 4f, 2fs
Firing Chart —	R	T	T
Maximum Power —	4	5	5
Damage Modifiers —			
+2	(1 - 8)	(1 - 10)	(1 - 10)
+1	(9 - 16)	(11 - 18)	(11 - 18)
Missile Weapon Type —	FP-3	FP-6	FP-5
Number —	3	3	3
Firing Arcs —	2f, 1a	2f, 1a	2f, 1a
Firing Chart —	D	O	R
Power To Arm —	1	1	1
Damage —	6	12	16

Shields Data:

Deflector Shield Type —	FSK	FSL	FSL
Shield Point Ratio —	1/2	1/3	1/3
Maximum Shield Power —	14	14	14

Combat Efficiency:

D —	82	106	113.5
WDF —	22.2	45.9	62.9

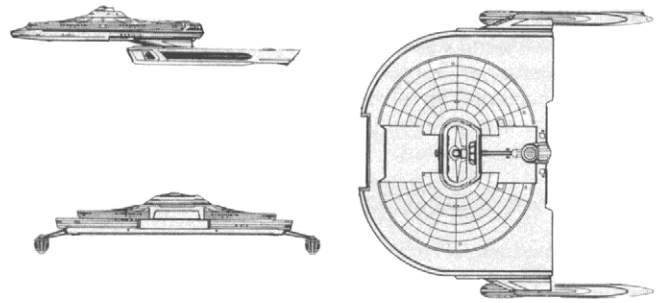

Notes:

Of the 185 *Brentons* built, 28 Mk Is, 57 Mk IIIs, and 18 Mk Vs remain in active service, with 12 Mk Is in reserve fleets; 1 Mk I is used by Star Fleet Training Command, 6 Mk Is have been destroyed, 1 Mk I has been captured by the Klingons, 1 Mk I and 1 Mk III are listed as missing, 2 Mk Is and 1 Mk III have been scrapped, and 2 Mk Is have been disarmed and sold to private commercial concerns.

The *Brenton* is produced at the Sol IV, Cait, and Morena shipyards at a combined rate of 12 per year.

18209 4865-4 7139-15

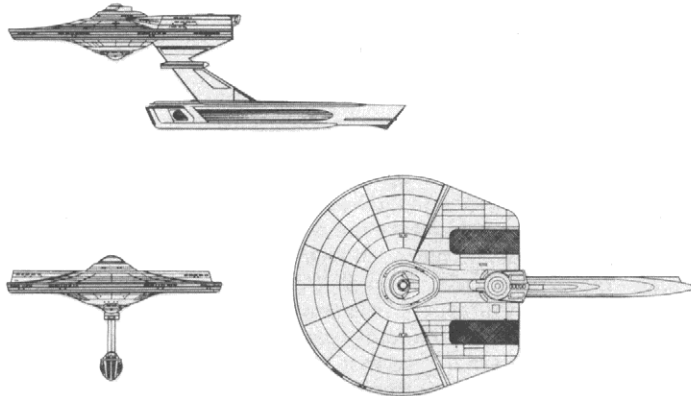

Notes:

Of the 108 *Durrett*s built, 102 remain in active service, 1 is used in Star Fleet Training Command, 2 have been destroyed, 2 are listed as missing, and 1 has been scrapped.

The *Durrett* is produced at the Sol II facility at a rate of 14 per year.

Durrett Class VIII Cruiser

Construction Data:

Model Numbers —	MK I
Date Entering Service —	2/1509
Number Constructed —	108

Hull Data:

Superstructure Points —	22
Damage Chart —	C
Size	
Length —	240 m
Width —	131 m
Height —	75 m
Weight —	101,400 mt
Cargo	
Cargo Units —	200 SCU
Cargo Capacity —	10,000 mt
Landing Capability —	None

Equipment Data:

Control Computer Type —	M-3
Transporters —	
standard 6-person	4
emergency 22-person	2
cargo	2

Other Data:

Crew —	320
Passengers —	10
Shuttlecraft —	4

Engines And Power Data:

Total Power Units Available —	32
Movement Point Ratio —	3/1
Warp Engine Type —	FWC-2
Number —	1
Power Units Available —	20
Stress Charts —	M/K
Maximum Safe Cruising Speed —	Warp 6
Emergency Speed —	Warp 8
Impulse Engine Type —	FIF-1
Power Units Available —	12

Weapons And Firing Data:

Beam Weapon Type —	FH-9
Number —	4 in 2 banks
Firing Arcs —	2/fp, 2fs
Firing Chart —	X
Maximum Power —	6
Damage Modifiers —	
+2	(1 - 12)
+1	(13 - 22)
Missile Weapon Type —	FP-6
Number —	2
Firing Arcs —	1f, 1a
Firing Chart —	O
Power To Arm —	1
Damage —	12

Shields Data:

Deflector Shield Type —	FSL
Shield Point Ratio —	1/3
Maximum Shield Power —	16

Combat Efficiency:

D —	100.5
WDF —	37.4

Epsilon Class III-IV Cutter

Construction Data:	MK I	MK II
<i>Model Numbers —</i>	III	IV
<i>Ship Class —</i>	2/1104	2/1412
<i>Date Entering Service —</i>	461	344
<i>Number Constructed —</i>		
Hull Data:		
<i>Superstructure Points —</i>	7	9
<i>Damage Chart —</i>	C	C
<i>Size</i>		
Length —	96 m	96 m
Width —	18 m	18 m
Height —	12 m	12 m
Weight —	17,925 mt	25,975 mt
<i>Cargo</i>		
Cargo Units —	5 SCU	5 SCU
Cargo Capacity —	250 mt	250 mt
Landing Capability —	Yes	Yes
Equipment Data:		
<i>Control Computer Type —</i>	L-14	L-14
<i>Transporters —</i>		
standard 6 person	1	1
combat 20 person	1	1
cargo	1	1
Other Data:		
<i>Crew —</i>	25	28
<i>Passengers —</i>	10	10
<i>Troops —</i>	10	10
Engines And Power Data:		
<i>Total Power Units Available —</i>	18	26
<i>Movement Point Ratio —</i>	2/1	3/1
<i>Warp Engine Type —</i>	FWA-2	FWH-1
Number —	2	2
Power Units Available —	8	10
Stress Charts —	J/M	Q/R
Maximum Safe Cruising Speed —	Warp 6	Warp 5
Emergency Speed —	Warp 8	Warp 6
<i>Impulse Engine Type —</i>	FIB 1	FIB 3
Power Units Available —	2	6
Weapons And Firing Data:		
<i>Beam Weapon Type —</i>	FH-6	FH-6
Number —	4 in 2 banks	4 in 2 banks
Firing Arcs —	2/p, 2/s	2/p, 2/s
Firing Chart —	N	N
Maximum Power —	3	3
Damage Modifiers —		
+2	(1 - 7)	(1 - 7)
+1	(8 - 13)	(8 - 13)
Shields Data:		
<i>Deflector Shield Type —</i>	FSB	FSB
Shield Point Ratio —	1/2	1/2
Maximum Shield Power —	9	8
Combat Efficiency:		
<i>D —</i>	49	47.9
<i>WDF —</i>	10	10

490 479

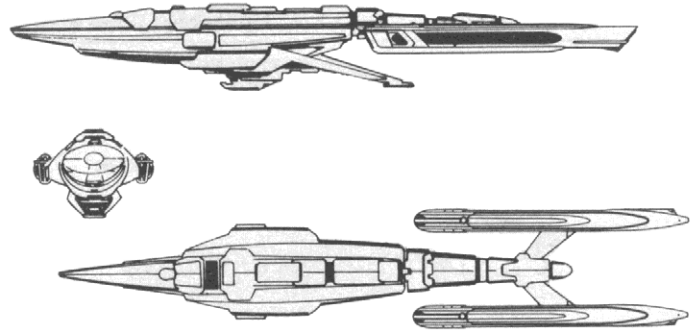

Notes:

Of the 805 *Epsilons* built, 363 Mk Is and 266 Mk IIs remain in active service, with 16 Mk Is and 8 Mk IIs in reserve fleets; 4 Mk Is and 2 Mk IIs are used by Star Fleet Training Command; 87 Mk Is and 41 Mk IIs have been destroyed, 4 Mk Is disappeared along the Triangle border, and 2 Mk Is disappeared on the Rimward frontier; 2 Mk Is and 4 Mk IIs have been scrapped, and 6 Mk Is have been sold to civilian commercial interests.

The *Epsilon* Class cutters are produced at the Morena, Salazaar, and Merak shipyards at a combined rate of 18 per year.

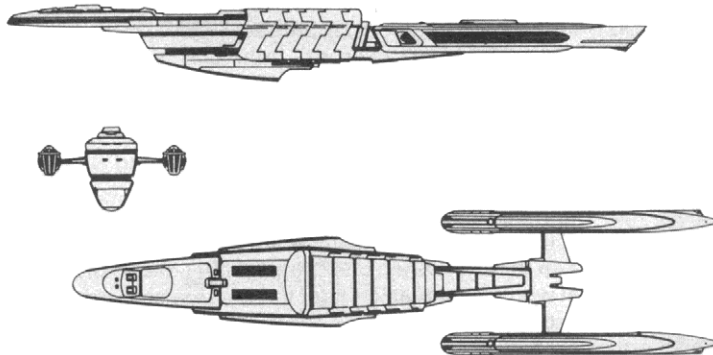

Notes:

Of the 1,297 *Solar* Class cutters built, 144 Mk IIIs and 524 Mk VIs remain in active service, with 196 Mk Is and 42 Mk IIIs in reserve fleets. Twenty-four Mk IIIs and 24 Mk VIs are used by Star Fleet Training Command; 79 Mk Is, 48 Mk IIIs, and 46 Mk VIs have been destroyed; 2 Mk Is, 1 Mk III and 3 Mk VIs are listed as missing; 16 Mk Is, 14 Mk IIIs, and 14 Mk VIs have been scrapped; and 81 Mk Is, 29 Mk IIIs, and 10 Mk VIs have been sold to civilian commercial concerns.

The *Solar* Class cutters are manufactured at the Salazaar and Alpha Centauri shipyards at a combined rate of 26 per year.

Solar Class III Cutter

Construction Data:	MK I	MK III	MK VI
<i>Model Numbers —</i>	19805-2/1501	2/1010	2/1206
<i>Date Entering Service —</i>	588	410	621
<i>Number Constructed —</i>			
Hull Data:			
<i>Superstructure Points —</i>	6	7	8
<i>Damage Chart —</i>	C	C	C
<i>Size</i>			
Length —	90 m	90 m	90 m
Width —	20 m	20 m	20 m
Height —	12 m	12 m	12 m
Weight —	17,100 mt	18,100 mt	20,400 mt
<i>Cargo</i>			
Cargo Units —	5 SCU	5 SCU	5 SCU
Cargo Capacity —	250 mt	250 mt	250 mt
Landing Capability —	Yes	Yes	Yes
Equipment Data:			
<i>Control Computer Type —</i>	L-14	L-14	L-14
<i>Transporters —</i>			
standard 6-person	1	1	1
combat 20-person	1	1	1
cargo	1	1	1
Other Data:			
<i>Crew —</i>	23	25	28
<i>Passengers —</i>	6	6	6
<i>Troops —</i>	10	10	10
Engines And Power Data:			
<i>Total Power Units Available —</i>	15	19	19
<i>Movement Point Ratio —</i>	1/1	1/1	1/1
<i>Warp Engine Type —</i>	FWA-1	FWA-2	FWA-2
Number —	2	2	2
Power Units Available —	6	8	8
Stress Charts —	G/K	J/M	J/M
Maximum Safe Cruising Speed —	Warp 7	Warp 7	Warp 7
Emergency Speed —	Warp 9	Warp 9	Warp 9
<i>Impulse Engine Type —</i>	FIA-3	FIA-3	FIA-3
Power Units Available —	3	3	3
Weapons And Firing Data:			
<i>Beam Weapon Type —</i>	FH-1	FH-1	FH-2
Number —	6 in 3 banks	6 in 3 banks	6 in 3 banks
Firing Arcs —	2/p, 2/s	2/p, 2/s	2/p, 2/s
Firing Chart —	F	F	H
Maximum Power —	2	2	3
Damage Modifiers —			
+1			(1 - 10)
Shields Data:			
<i>Deflector Shield Type —</i>	FSB	FSB	FSB
Shield Point Ratio —	1/2	1/2	1/2
Maximum Shield Power —	11	11	11
Combat Efficiency:			
<i>D —</i>	66.6	80.6	80.6
<i>WDF —</i>	3.0	3.0	7.8

17.8 24.18 31.28

Baker Class IX Destroyer

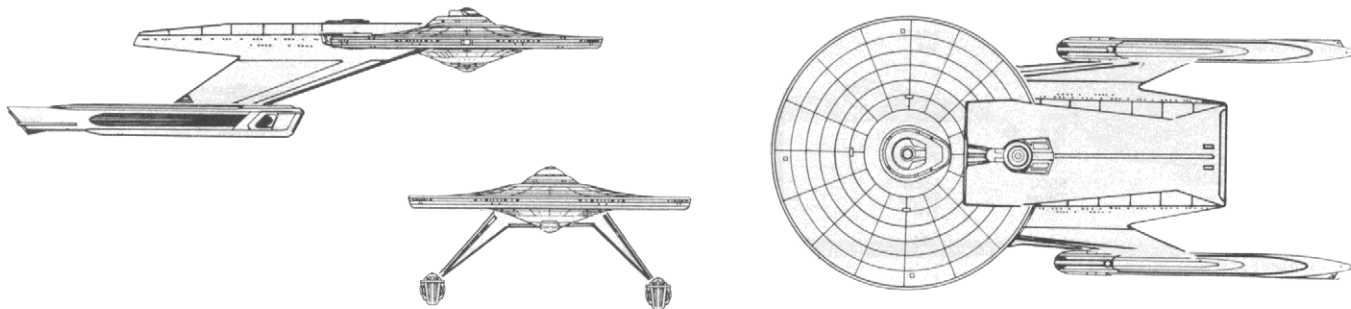

Construction Data:

Model Numbers —	MK II	MK IV
Date Entering Service —	2/1606	2/1912
Number Constructed —	162	62

Hull Data:

Superstructure Points —	15	17
Damage Chart —	C	C
Size		
Length —	301 m	301 m
Width —	148 m	148 m
Height —	77 m	77 m
Weight —	121,300 mt	125,600 mt

Cargo

Cargo Units —	110 SCU	110 SCU
Cargo Capacity —	5,500 mt	5,500 mt
Landing Capability —	None	None

Equipment Data:

Control Computer Type —	M-3	M-4
Transporters —		
standard 6-person	4	4
emergency 22-person	2	2
cargo	1	1

Other Data:

Crew —	265	273
Passengers —	15	15
Shuttlecraft —	2	2

Engines And Power Data:

Total Power Units Available —	30	38
Movement Point Ratio —	3/1	3/1
Warp Engine Type —	FWE-2	FWE-2
Number —	2	2
Power Units Available —	13	13
Stress Charts —	G/K	G/K
Maximum Safe Cruising Speed —	Warp 7	Warp 7
Emergency Speed —	Warp 9	Warp 9
Impulse Engine Type —	FID-2	FIF-1
Power Units Available —	4	12

Weapons And Firing Data:

Beam Weapon Type —	FH-8	FH-8
Number —	6 in 3 banks	6 in 3 banks
Firing Arcs —	4 p/l/s, 2f	4 p/l/s, 2f
Firing Chart —	T	T
Maximum Power —	5	5
Damage Modifiers —		
+2	(1 - 10)	(1 - 10)
+1	(11 - 18)	(11 - 18)
Missile Weapon Type —	FP-2	FP-1
Number —	2	2
Firing Arcs —	f	f
Firing Chart —	H	L
Power To Arm —	1	1
Damage —	6	10

Shields Data:

Deflector Shield Type —	FSI	FSI
Shield Ppint Ratio —	1/3	1/3
Maximum Shield Power —	12	12

Combat Efficiency:

D —	81.5	96.3
WDF —	27.6	34.8

The *Baker* Class destroyer has a unique development history. When the original contracts were let out, they called for a research vessel with limited combat capabilities. The designs for the ship were accepted by Star Fleet Procurement, and, on Stardate 2 1403, the actual construction of the *Baker* Class research cruiser began.

As the main hull neared completion, Star Fleet decided that a destroyer was needed to supplement the *Larson* Class. At this same time, the Admiralty was of the opinion that fewer research cruisers would be needed on the frontiers. The *Baker* class was then dropped as a research cruiser and redesignated a destroyer.

In order to accomplish its mission as a destroyer, the *Baker's* design underwent several changes. The laboratory facilities were removed and crew quarters and recreation areas were expanded. The *Baker* class vessels are well known for these spacious quarters and crew comforts. Another change came in the weaponry. The original design had only four phasers, and as can be seen, the finished design, known as the Mk II, was fitted with six phasers and two torpedoes.

On Stardate 2 1606 the *Baker* Class destroyer was brought into service with the commissioning of the *USS Baker*, *USS Stafford*, and *USS Peterson*. Since that time, 224 ships of this class have been commissioned. As was intended, these vessels are being used to replace the aging *Larson* Class destroyers in more hostile areas, the latter being used more and more along trailing and rimward frontiers.

The *Baker* Class has a compartmented dual-wall internal structure to give additional protection from explosive decompression during battle. Earlier designs with single-wall protection often ruptured when one compartment decompressed, victims of a domino effect that would eventually render the entire vessel incapable of sustaining itself. Although compartmentation is not new in ship design, double walls separated by a pressurized dead space was. Such a dead space counteracts the forces on the outer wall surfaces by means of sensors that detect any changes in pressure and trigger units that regulate the pressure inside the dead space. This system has become a standard feature on all Federation warships.

The *Baker* Class destroyer is the first vessel in Star Fleet to be designed with the newer style nacelle; previous uses were all refits. The FWE-2 warp drive system was installed to give a cruising speed of Warp 7 and temporary speeds of Warp 8, as well as great maneuverability, making it more efficient in battle than many of its counterparts. The weapons arrangement of the *Baker* Class is unusual by Star Fleet standards. Two of the phaser banks are capable of firing in all quadrants except directly to the rear, unlike most other Federation vessels on which they are usually positioned to fire in only two quadrants.

The *Baker* Class remained unchanged until an experimental model, the *USS Knutson*, completed its testing of an impulse drive system that would increase the total power output of the vessel by 25%. The Mk III went into production on Stardate 2 1804, but was quickly replaced by the Mk IV with upgraded FP-1 photon torpedoes. All Mk III's have been refitted to this design.

Wilkerson Class IX Destroyer

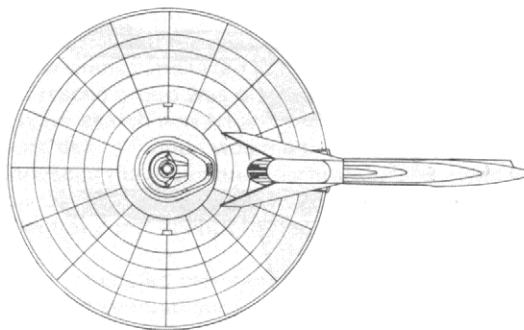
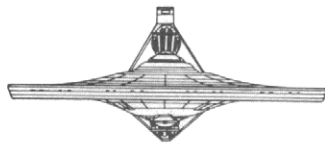
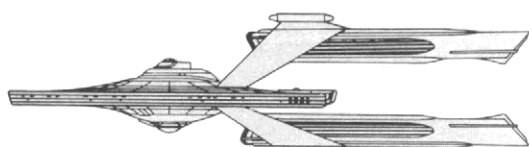

Construction Data:

Model Numbers —	MK I
Date Entering Service —	2/1804
Number Constructed —	132

Hull Data:

Superstructure Points —	15
Damage Chart —	C
Size	
Length —	240 m
Width —	150 m
Height —	60 m
Weight —	112,500 mt

Cargo

Cargo Units —	100 SCU
Cargo Capacity —	5,000 mt
Landing Capability —	None

Equipment Data:

Control Computer Type —	M-3
Transporters —	
standard 6-person	3
emergency 22-person	2
cargo	1

Other Data:

Crew —	200
Passengers —	20
Shuttlecraft —	2

Engines And Power Data:

Total Power Units Available —	38
Movement Point Ratio —	3/1
Warp Engine Type —	FWF-2
Number —	2
Power Units Available —	13
Stress Charts —	G/K
Maximum Safe Cruising Speed —	Warp 7
Emergency Speed —	Warp 9
Impulse Engine Type —	FIF-1
Power Units Available —	12

Weapons And Firing Data:

Beam Weapon Type —	FH-3
Number —	4 in 2 banks
Firing Arcs —	2fp, 2fs
Firing Chart —	W
Maximum Power —	S
Damage Modifiers —	
+3	(1 - 10)
+2	(11 - 17)
+1	(18 - 20)

Missile Weapon Type —

Number —	2
Firing Arcs —	1f, 1a
Firing Chart —	L
Power To Arm —	1
Damage —	10

Shields Data:

Deflector Shield Type —	FSI
Shield Point Ratio —	1/3
Maximum Shield Power —	12

Combat Efficiency:

D —	93.5
WDF —	32.0

3022-5

Notes:

The *Wilkerson* Class destroyers, which first entered service on Stardate 2/1804, have since become a favorite among the personnel of Star Fleet's Destroyer Command. These sleek ships are not only fast and maneuverable, but also well-armed and shielded. Spacious crew quarters and work areas make tours of duty aboard a *Wilkerson* much sought-after.

The *Wilkersons* were tested for combat readiness shortly after they began arriving at their duty stations. Six of them participated in Solar Wind IV, a fleet-level training operation designed to test the fleet's ability to respond to and repulse an invasion by limited Romulan forces. The after-action reports showed the *Wilkerson* to be a formidable opponent. During this operation, the *Wilkersons* were in combat four times and suffered no losses. The only pertinent negative reports from the operation were due to an overzealous captain who was so flushed with victory during a successful engagement that he pursued the fleeing enemy ships and left his support behind. Luckily, he broke off the action after realizing that he was the only ship in pursuit of the five enemy ships.

During a docking operation on Stardate 2/2010, the *USS Carmichael* was pulled into the *USS Henley*. Both *Wilkersons* were destroyed, along with the docking facility and 730 personnel. Post-accident investigations revealed that a faulty tractor beam guidance control aboard the docking facility pulled the *Carmichael* into the *Henley*.

Of the 132 *Wilkersons* built, 128 remain in active service, 2 are used by Star Fleet Training Command, and 2 have been destroyed. The *Wilkerson* Class destroyers are produced at the Sol IV and Salazaar shipyards at a combined rate of 26 per year. Star Fleet has contracted for the construction of 340 of these destroyers.

Larson Class VII Destroyer



Construction Data:

	Mk I	Mk II	Mk VI	Mk VII
Model Numbers —	1/8801-2/0109	1/9804-2/2205	2/0912	2/1403
Date Entering Service —	109	34	6	13
Number Constructed —				
Hull Data:				
Superstructure Points —	11	10	14	16
Damage Chart —	C	C	C	C
Size				
Length —	269 m	269 m	269 m	272 m
Width —	134 m	134 m	134 m	134 m
Height —	62 m	62 m	62 m	62 m
Weight —	82,400 mt	80,750 mt	87,000 mt	88,600 mt
Cargo				
Cargo Units —	200 SCU	200 SCU	200 SCU	200 SCU
Cargo Capacity —	10,000 mt	10,000 mt	10,000 mt	10,000 mt
Landing Capability —	None	None	None	None
Equipment Data:				
Control Computer Type —	M-1	M-1	M-1	M-1
Transporters —				
standard 6-person	4	4	4	4
emergency 22-person cargo	3	3	3	3
	1	1	1	1
Other Data:				
Crew —	195	195	200	200
Passengers —	10	10	10	10
Shuttlecraft —	6	6	6	6
Engines And Power Data:				
Total Power Units Available —	22	22	23	28
Movement Point Ratio —	2/1	2/1	2/1	2/1
Warp Engine Type —	FWC-2	FWC-2	FWC-2	FWC-2
Number —	1	1	1	1
Power Units Available —	20	20	20	20
Stress Charts —	M/K	M/K	M/K	M/K
Maximum Safe Cruising Speed —	Warp 7	Warp 7	Warp 7	Warp 7
Emergency Speed —	Warp 9	Warp 9	Warp 9	Warp 9
Impulse Engine Type —	FIB-1	FIB-1	FIC-2	FIE-2
Power Units Available —	2	2	3	8
Weapons And Firing Data:				
Beam Weapon Type —	FL-2	FH-4	FH-7	FH-7
Number —	6 in 3 banks	6 in 3 banks	6 in 3 banks	6 in 3 banks
Firing Arcs —	2f/p, 2f, 2f	2f/p, 2f, 2f/s	2f/p, 2f, 2f/s	2f/p, 2f, 2f/s
Firing Chart —	F	Q	Q	Q
Maximum Power —	2	3	4	4
Damage Modifiers —	None			
+2		(1 - 8)	(1 - 8)	(1 - 8)
+1		(9 - 15)	(9 - 15)	(9 - 15)
Missile Weapon Type —	FAC-1	FP-2	FP-2	FP-2
Number —	1	2	2	2
Firing Arcs —	f	f	f	f
Firing Chart —	F	H	H	H
Power To Arm —	3	1	1	1
Damage —	8	6	6	6
Shields Data:				
Deflector Shield Type —	FSC	FSC	FSD	FSF
Shield Point Ratio —	1/1	1/1	1/2	1/2
Maximum Shield Power —	8	8	7	10
Combat Efficiency:				
D —	36.2	34.8	63.0	77.0
WDF —	4.2	19.6	23.2	23.2

152.04 682.08 1461.6 1786.4

Designed at the same time as the *Nelson* class scouts and the *Constitution* class cruisers, *Larson* Class destroyers share many of the same physical features of these ships. An efficient ship that performed its function well, it was intended to perform the same tasks as other dual-function vessels, namely both research and defense. Even so, most of the existing *Larsons* in service are employed by Star Fleet's Military Operations Command, with several serving in the Galaxy Exploration Command.

Destroyers such as the *Larson* frequently are employed on patrol duty along the frontier areas. In time of war or other military emergencies, *Larsons* and other destroyers may be assigned to escort convoys or used as scouts by squadrons or small fleets. With its array of weapons, it is a fine combat vessel, though not as powerful as a cruiser or larger ship.

As can be seen by reviewing the statistics, the *Larson* Mk I was introduced into service on Stardate 1/8801, remaining unchanged until the introduction of the Mk II on Stardate 1/9804, when laser weaponry was replaced by the newer phaser and photon technology. All Mk I vessels were refitted with the new weapons by 2/0109. Several small interior changes were also made, but these did not affect the combat performance of the vessels until the introduction of the Mk VI.

The Mk VI mounted a more powerful impulse drive system, improved phaser weapons and the more efficient FSD shield generators. The Mk VII, introduced on Stardate 2/1403, mounted the newer style engine nacelle and a more powerful impulse drive system. This increased the overall power output by 25% and extended the service life of the *Larson* class by several years. As of Stardate 2/2205, all *Larsons* in active service have been upgraded to the Mk VI, and several have been modified to Mk VII's.

Production of the *Larson* Class was halted on Stardate 2/1808 with the commissioning of the *USS Juno*. This class is being supplemented by several newer destroyer designs and may see and end to service within the next 5 to 7 years.

No ships sold to the private sector have been refit, and most retain the characteristics they had at the time of sale. All vessels sold were disarmed by Star Fleet, though the weapon-mounting hardpoints usually were left intact.

Historical Notes

Larsons are named for military leaders and battles of Terran origin. The class vessel is named for Admiral William G. Larson, hero of the battle at Gamma Hydra during the Romulan War. The only exception to this naming convention is NCC 4305 *Theleth*, which is named after an Andorian admiral who defeated the Klingons in a pitched battle at Donovan's Star at the cost of his own ship and crew.

The ships *Hammurabi* and *Troy* were both destroyed while escorting a convoy of merchant ships bound for a frontier area. During this battle, seventeen freighters were destroyed and an additional four were taken as prizes by the Klingons. Of the five ships that survived the encounter, all reported that the *Hammurabi* destroyed two Klingon D-7 cruisers and crippled two others before being destroyed itself. The *Troy* apparently was disabled in the initial exchange of fire and left for dead. When a Klingon cruiser ventured too close to the derelict, however, it opened fire and destroyed the enemy vessel in a single volley. Of course, without maneuvering power, the *Troy* later was easily dispatched.

On Stardate 2:0208, the *Bolivar* led a small detachment consisting of the *Normandy*, *Alesia*, *Babur*, and *Tecumseh* into an uncontrolled area near the Romulan Neutral Zone. The task force maintained radio silence and failed to report back at its scheduled time. When extensive communications attempts were made unsuccessfully, a rescue group was dispatched to the last reported position of the task force. Upon arrival, nothing was to be found, and an extensive search was begun, ultimately discovering the engine nacelle of the *Alesia* adrift in an unknown asteroid cluster. At the time no determination was made as to what had caused the loss of the ships, but it was suspected by many that the Romulans had ambushed the group and successfully destroyed them before they were able to send a call for aid. This theory was never proved, and no action was ever taken against the Romulans, largely because it was felt that the Romulans could not have crossed the Neutral Zone unnoticed. Since the discovery of the Romulan cloaking capability, the theory has been given new weight.

On Stardate 2:1502, the *USS Richtofen* was recalled for an engine refit and scheduled maintenance to shipboard systems. As the ship's refit and maintenance checks neared completion, spirited Ensigns and sympathetic workers painted it bright red in honor of its namesake. Star Fleet Command has decided to leave the ship this color despite the breach of regulations, though all Ensigns were mildly disciplined. The vessel is still in service and is assigned to the Klingon sector.

On its maiden flight, the *USS Sheridan* experienced a critical overload in its warp drive system. All backup systems failed to correct the problem. It was decided to jettison the engine pod because an uncontrolled matter anti-matter mix was underway and could not be stopped. The systems used to eject the engine also failed, and the ship was totally destroyed in the subsequent explosion. Three crewmembers who had taken refuge in a shuttle survived.

The *Larson* Class destroyers were produced at the Sol V and Proxima shipyards.

Disposition:

The following list of *Larson* Class destroyers shows their hull numbers, name, model, date entering service, and current disposition. The disposition is represented by letter codes given below and is followed by the date of occurrence, if known.

I	Inactive	R2	Refit to Mk II
D	Destroyed by hostile action or natural disaster.	R6	Refit to Mk VI
DK	Destroyed in Four Years War	R7	Refit to Mk VII
Sc	Scrapped	T	Used by Training Command
L	Lost, whereabouts unknown		

NCC 4300	Larson	I	1/8801, R2 2/0102, R6 2/1111, R7 2/1410	NCC 4358	Alaric	I	1/8412, DK 1/9802	NCC 4417	Moltke	I	1/9803, R2 2/0012, R6 2/1010
NCC 4301	Midway	I	1/8801, DK 1/9411	NCC 4360	Orleans	I	1/9501, D 1/9909	NCC 4418	Nashimov	I	1/9803, R2 2/0104, D 2/9801
NCC 4302	Coral Sea	I	1/8802, R2 2/0006, R6 2/1002, R7 2/1501	NCC 4361	Pendragon	I	1/9502, R2 1/9809, R6 2/1202, R7 2/1606	NCC 4419	Balatkava	II	1/9806, R6 2/1007, R7 2/1610
NCC 4303	Tannenbergl	I	1/8803, R2 1/9809, R6 2/1001	NCC 4362	Justinian	I	1/9503, R2 1/9912, R6 2/1011, R7 2/1410, 12/1511	NCC 4420	Dreyfus	II	1/9806, R6 2/1110, R7 2/1510
NCC 4304	Trafalgar	I	1/8803, R2 1/9806, R6 2/1102, R7 2/1408	NCC 4363	Tiberius	I	1/9506, R2 2/0012, R6 2/1201, R7 2/1603	NCC 4421	Mahdi	II	1/9808, L 2/0603
NCC 4305	Theleth	I	1/8804, R2 1/9806, R6 2/1202, R7 2/1503	NCC 4364	Charlemagne	I	1/9506, R2 1/9908, R6 2/0912, R7 2/1802	NCC 4422	Rorkes Drift	II	1/9809, R6 2/1202, R7 2/1710
NCC 4306	Waterloo	I	1/8806, D 1/9909	NCC 4366	Jahur	I	1/9506, R2 1/9805, R6 2/1401	NCC 4423	Semmes	II	1/9811, D 1/9912
NCC 4307	Borodino	I	1/8807, R2 1/9805, R6 2/0912, R7 2/1404	NCC 4367	Alexander	I	1/9506, R2 1/9906, R6 2/1212, R7 2/1703	NCC 4424	Chief Joseph	II	1/9812, R6 2/1108, R7 2/1801
NCC 4308	Austerlitz	I	1/8807, DK 1/9702	NCC 4368	Saladin	I	1/9507, R2 2/0109, R6 2/1103, R7 2/1512	NCC 4426	Hindenburg	II	1/9903, R6 2/1208, R7 1/612
NCC 4309	Normandy	I	1/8807, R2 2/0010, L 2/0208	NCC 4369	Hardraade	I	1/9508, R2 2/0003, R6 2/0912, R7 2/1801	NCC 4427	Foch	II	1/9907, D 2/1111
NCC 4310	Marathon	I	1/8810, R2 1/9909, R6 2/1104	NCC 4371	Frederick	I	1/9510, R2 2/0006, R6 2/1305	NCC 4428	Pershing	II	1/9908, R6 2/1101, R7 2/1610
NCC 4311	Pharsalus	I	1/8810, DK 1/9506	NCC 4372	Acre	I	1/9510, DK 1/9609	NCC 4429	Nicholas	II	1/9909, R6 2/1302, R7 2/1802
NCC 4312	Cre'cy	I	1/8910, R2 1/9804, R6 2/1107	NCC 4373	Rajendra	I	1/9602, R2 2/0009, 12/1606	NCC 4430	Kermel	II	1/9912, R6 2/1010, R7 2/1509
NCC 4313	Poitiers	I	1/8903, R2 1/9901, 12/0909	NCC 4374	Bahu	I	1/9603, DK 1/9609	NCC 4431	Oyama	II	2/0003, R6 2/1311, R7 2/1412
NCC 4314	Agincourt	I	1/8903, R2 1/9912, R6 2/1011, S 2/1202	NCC 4375	Genghis Khan	I	1/9603, R2 1/9910, R6 2/1010, R7 2/1602	NCC 4432	Pilsudski	II	2/0005, R6 2/1212, R7 2/1609
NCC 4315	Bienheim	I	1/8906, R2 1/9903, R6 2/1103, R7 2/1511	NCC 4376	Liegnitz	I	1/9603, R2 2/0101, 12/1304	NCC 4433	Port Arthur	II	2/0010, R6 2/1301, R7 2/1510
NCC 4316	Torgau	I	1/8908, R2 1/9805, R6 2/1001, R7 2/1502	NCC 4377	Cromwell	I	1/9604, R2 2/0107, R6 2/1103, R7 2/1711	NCC 4434	Tsushima	II	2/0102, D 2/1309
NCC 4317	Eylau	I	1/8909, DK 1/9602	NCC 4378	Joan Of Arc	I	1/9605, R2 2/0001, R6 2/1208, R7 2/1510	NCC 4435	Marne	II	2/0108, R6 2/1403, R7 1409
NCC 4319	Leyte	I	1/8910, R2 1/9807, R6 2/0912, R7 2/1409	NCC 4379	San Miguel	I	1/9606, DK 1/9611	NCC 4436	Richtofen	II	2/0111, R6 2/1311, R7 2/1712
NCC 4320	Leipzig	I	1/8910, R2 2/0104, 12/1010	NCC 4380	Babur	I	1/9606, R2 1/9901, R6 2/1008	NCC 4437	MacArthur	II	2/0205, R6 2/1301, R7 2/1610
NCC 4322	Buena Vista	I	1/9002, DK 1/9506	NCC 4381	Hideyoshi	I	1/9607, R2 1/9809, R6 2/1301	NCC 4438	Montgomery	II	2/0209, D 2/1205
NCC 4323	Garbo	I	1/9004, R2 1/9809, R6 2/1002	NCC 4382	Bayinnaung	I	1/9608, DK 1/9711	NCC 4439	Nimitz	II	2/0212, R6 2/1109, R7 2/1412
NCC 4324	Gettysburg	I	1/9005, R2 1/9804, R6 2/1006, R7 2/1403	NCC 4383	Cortez	I	1/9609, R2 1/9806, R6 2/1011, R7 2/1512	NCC 4440	Zhukov	II	2/0306, R6 2/1212, R7 2/1711
NCC 4325	Castinair	I	1/9006, R2 1/9901, R6 2/1107, R7 2/1412	NCC 4384	Tenochtitlan	I	1/9609, R2 2/0101, 12/1303	NCC 4441	Eisenhower	II	2/0311, R6 2/1203, D 2/1503
NCC 4326	Shioph	I	1/9009, R2 1/9812, S 2/0802	NCC 4385	Adolphus	I	1/9610, R2 1/9912, R6 2/1208, R7 2/1708	NCC 4442	Wavell	II	2/0409, D 2/1004
NCC 4327	Gallipoli	I	1/9011, R2 1/9805, R6 2/1303, R7 2/1801	NCC 4386	de Tourville	I	1/9610, DK 1/9801	NCC 4444	Doentzi	II	2/0501, R6 2/1105, R7 2/1404
NCC 4328	Jutland	I	1/9012, R2 1/9808, R6 2/1401, R7 2/1806	NCC 4387	Brietefeld	I	1/9611, R2 2/0002, R6 2/1312	NCC 4445	Tedder	II	2/0512, R6 2/1012, R7 2/1709
NCC 4329	Anzio	I	1/9104, DK 9512	NCC 4388	Bradley	I	1/9611, R2 1/9806, R6 2/1111, R7 2/1712	NCC 4447	Kursk	II	2/0611, R6 2/1302, R7 2/1606
NCC 4331	Corregidor	I	1/9107, R2 1/9807, R6 2/1002, S 2/1111	NCC 4389	Blake	I	1/9612, R2 1/9910, R6 2/1207, R7 2/1801	NCC 4448	Axanar	II	2/0612, R6 2/1405, R7 2/1609
NCC 4332	Guadalcanal	I	1/9108, R2 1/9907, R6 2/0912, R7 2/1411	NCC 4391	Nhat-La	I	1/9701, R2 2/0107, R6 2/1304, R7 2/1407	NCC 4449	Collinswill	II	2/0706, R6 2/1308, R7 2/1504, 12/2012
NCC 4333	Iwo Jima	I	1/9108, DK 1/9512	NCC 4392	Marlborough	I	1/9702, R2 2/0005, R6 2/1207	NCC 4450	Inchon	II	2/0710, R6 2/1211, R7 2/1502
NCC 4334	Okinawa	I	1/9108, R2 2/0008, R6 2/1004	NCC 4393	Ali Bey	I	1/9702, D 2/0001	NCC 4451	Dayan	II	2/0805, R6 2/1301, L 2/2104
NCC 4335	Ramses	I	1/9110, R2 1/9912, R6 2/1009, R7 2/1410	NCC 4394	Washington	I	1/9702, R2 2/0010, R6 2/1105, R7 2/1801	NCC 4452	Doermann	II	2/0902, R6 2/1212, R7 2/1802
NCC 4336	Thebes	I	1/9112, DK 1/9801	NCC 4395	Wellington	I	1/9703, R2 2/0011, R6 2/1208	NCC 4453	Chryse	II	2/0903, R6 2/1012, R7 2/1509, S 2/2202
NCC 4337	Hammurabi	I	1/9201, DK 1/9604	NCC 4397	Lafayette	I	1/9704, R2 1/9901, R6 2/1202, R7 2/1709	NCC 4454	Buraiiev	II	2/0906, R6 2/1106, R7 2/1806
NCC 4338	Troy	I	1/9204, DK 1/9604	NCC 4398	Murat	I	1/9704, R2 1/9807, R6 2/1204, R7 2/1505	NCC 4455	Titan Plain	II	2/0909, R6 2/1306, R7 2/1709
NCC 4339	Chou	I	1/9206, R2 1/9903, R6 2/1008, S 2/1302	NCC 4399	Ney	I	1/9705, DK 1/9711	NCC 4456	Kohlar	VI	2/1002, R7 2/1511
NCC 4340	Xerxes	I	1/9208, R2 1/9901, R6 2/1202, R7 2/1412, S 2/1811	NCC 4400	Von Blucher	I	1/9706, R2 1/9910, R6 2/1101, R7 2/1603	NCC 4457	Cona'Re	VI	2/1004, R7 2/1704
NCC 4341	Salamis	I	1/9208, R2 1/9804, 12/2001	NCC 4401	Khartoum	I	1/9708, R2 2/0009, R6 2/1003	NCC 4458	Conley	VI	2/1107, R7 2/1801
NCC 4342	Xenophon	I	1/9211, R2 1/9903, R6 2/1211, R7 2/1602	NCC 4402	Tecumseh	I	1/9709, R2 1/9901, L 2/0208	NCC 4459	Timoshenko	VI	2/1202, R7 2/1711
NCC 4343	Julius Caesar	I	1/9211, R2 2/0013, S 2/1704	NCC 4403	Perry	I	1/9711, R2 1/9908, R6 2/1112, R7 2/1803	NCC 4460	Aguilar	VI	2/1210, R7 2/1708
NCC 4344	Napoleon	I	1/9303, R2 1/9807, R6 2/0912, R7 2/1509	NCC 4404	Hastings	I	1/9711, R2 1/9910, R6 2/1304, R7 2/1701	NCC 4461	Stalngard	VI	2/1309
NCC 4345	Cochise	I	1/9306, R2 2/0106, R6 2/1102, R7 2/1403	NCC 4405	Jackson	I	1/9712, R2 2/0002, D 2/0505	NCC 4462	Imbrium	VI	2/1403
NCC 4346	Lutzen	I	1/9309, R2 1/9804, R6 2/1201	NCC 4407	San Jacinto	I	1/9712, R2 2/0010, R6 2/1102, R7 2/1604	NCC 4463	Sheridan	VII	2/1403, D 2/1403
NCC 4347	Sun Tzu	I	1/9311, R2 1/9911, R6 2/1006, R7 2/1803	NCC 4408	Palo Alto	I	1/9801, R2 1/9806, R6 2/1206, R7 2/1409	NCC 4464	Choam	VII	2/1406
NCC 4348	Demetrius	I	1/9311, DK 1/9503	NCC 4409	Scott	I	1/9801, DK 1/9802	NCC 4465	Varistan	VII	2/1501
NCC 4349	Hannibal	I	1/9402, R2 1/9804, R6 2/1106, R7 2/1910	NCC 4410	Rommel	I	1/9801, R2 1/9808, R6 2/1212, R7 2/1606	NCC 4466	Maoribunde	VII	2/1508
NCC 4351	Thermopylae	I	1/9406, R2 1/9808, R6 2/1303	NCC 4411	Bolivar	I	1/9801, R2 1/9809, R6 2/1206, R7 2/1601	NCC 4468	James	VII	2/1601
NCC 4352	Scipio	I	1/9409, R2 2/0102, R6 2/1105, R7 2/1611	NCC 4412	San Martin	I	1/9801, R2 1/9808, R6 2/1206, R7 2/1601	NCC 4469	Petrovich	VII	2/1605
NCC 4353	Cannae	I	1/9409, R2 2/0102, R6 2/0912, S 2/1208	NCC 4413	Boycas	I	1/9801, DK 1/9803	NCC 4470	Schultz	VII	2/1609
NCC 4354	Alesia	I	1/9409, R2 2/0003, L 2/0208	NCC 4414	Dewey	I	1/9801, R2 2/0109, R6 2/1310, R7 2/1606	NCC 4471	Petaiv	VII	2/1707
NCC 4355	Marc Antony	I	1/9409, R2 2/0109, 12/2002	NCC 4415	Lee	I	1/9802, R2 2/0109, R6 2/1202	NCC 4472	de Gaulle	VII	2/1707
NCC 4356	Liu Pang	I	1/9410, R2 1/9809, R6 2/1010, R7 2/1801	NCC 4416	Grant	I	1/9802, R2 2/0103, R6 2/1008, R7 2/1505	NCC 4473	Trenton	VII	2/1803
NCC 4357	Constantine	I	1/9411, R2 1/9911, 12/1010					NCC 4474	Calisto	VII	2/1808
								NCC 4475	Juno	VII	2/1808

Lenthal Class IX Destroyer

Construction Data:		
Model Numbers —	Mk II	Mk V
Date Entering Service —	2/1202	2/1708
Number Constructed —	201	110
Hull Data:		
Superstructure Points —	18	19
Damage Chart —	C	C
Size:		
Length —	260 m	260 m
Width —	110 m	110 m
Height —	40 m	40 m
Weight —	133,700 mt	135,300 mt
Cargo:		
Cargo Units —	100 SCU	100 SCU
Cargo Capacity —	5,000 mt	5,000 mt
Landing Capability —	None	None
Equipment Data:		
Control Computer Type —	M-2	M-2
Transporters —		
standard 6 person	4	4
emergency 22 person	2	2
cargo	1	1
Other Data:		
Crew —	160	165
Passengers —	10	10
Shuttlecraft —	2	2
Engines And Power Data:		
Total Power Units Available —	36	40
Movement Point Ratio —	3/1	3/1
Warp Engine Type —	FWD-1	FWD-1
Number	2	2
Power Units Available —	12	12
Stress Charts —	L/G	L/G
Maximum Safe Cruising Speed —	Warp 7	Warp 7
Emergency Speed —	Warp 9	Warp 9
Impulse Engine Type —	FIF-1	FIF-2
Power Units Available —	12	16
Weapons And Firing Data:		
Beam Weapon Type —	FH-12	FH-13
Number	6 in 2 banks	6 in 2 banks
Firing Arcs	315/330	315/330
Firing Chart —	R	T
Maximum Power —	6	8
Damage Modifiers —		
+3	(1 - 9)	(1 - 5)
+2	(10 - 16)	(6 - 12)
+1		(13 - 18)
Shields Data:		
Deflector Shield Type —	FSH	FSH
Shield Point Ratio —	1/2	1/2
Maximum Shield Power —	12	12
Combat Efficiency:		
D —	77.7	82.1
WDF —	29.4	39
	2284.4	3201.9

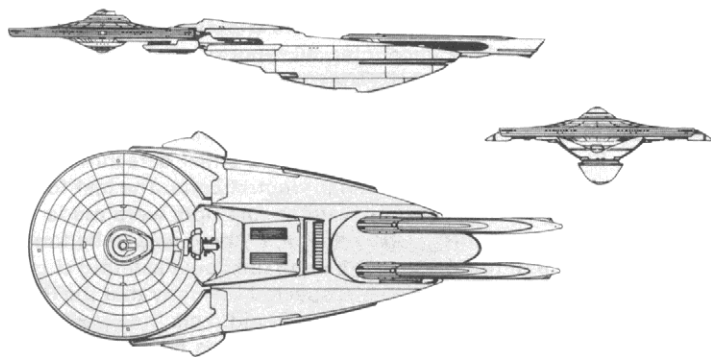

Notes:

Of the 311 *Lenthals* built, 161 Mk IIs and 98 Mk Vs remain in active service, with 10 Mk IIs in reserve fleets; 2 Mk IIs are used by Star Fleet Training Command; 22 Mk IIs and 10 Mk Vs have been destroyed; 2 Mk IIs are listed as missing; 2 Mk IIs and 2 Mk Vs have been scrapped; and 2 Mk IIs have been sold to civilian commercial concerns.

The *Lenthal*, an Andorian design, is manufactured at Salazaar at a rate of 18 per year.

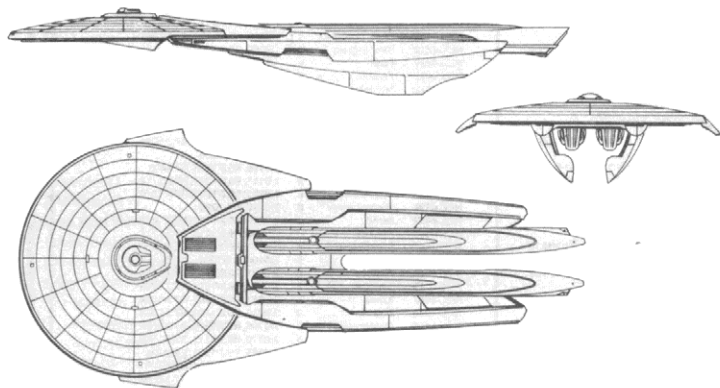

Thufir Class VIII-IX Destroyer

Construction Data:		
Model Numbers —	Mk I	Mk III
Ship Class —	VIII	IX
Date Entering Service —	2/1011	2/1503
Number Constructed —	226	148
Hull Data:		
Superstructure Points —	15	16
Damage Chart —	C	C
Size:		
Length —	280 m	280 m
Width —	130 m	130 m
Height —	40 m	40 m
Weight —	110,900 mt	132,430 mt
Cargo:		
Cargo Units —	100 SCU	100 SCU
Cargo Capacity —	5,000 mt	5,000 mt
Landing Capability —	None	None
Equipment Data:		
Control Computer Type —	M-3	M-3
Transporters —		
standard 6 person	3	3
emergency 22 person	2	2
cargo	1	1
Other Data:		
Crew —	180	180
Passengers —	15	15
Shuttlecraft —	4	4
Engines And Power Data:		
Total Power Units Available —	29	39
Movement Point Ratio —	3/1	2/1
Warp Engine Type —	FWE-2	FWD-2
Number	2	2
Power Units Available —	13	18
Stress Charts —	G/K	M/G
Maximum Safe Cruising Speed —	Warp 7	Warp 6
Emergency Speed —	Warp 9	Warp 8
Impulse Engine Type —	FIC-2	FIC-2
Power Units Available —	3	3
Weapons And Firing Data:		
Beam Weapon Type —	FH-5	FH-5
Number	6 in 3 banks	6 in 3 banks
Firing Arcs	21p, 21fs, 2a	21p, 21fs, 2a
Firing Chart —	R	R
Maximum Power —	4	4
Damage Modifiers —		
+2	(1 - 8)	(1 - 8)
+1	(9 - 16)	(9 - 16)
Missile Weapon Type —	FP-2	FP-2
Number	2	2
Firing Arcs —	1	1
Firing Chart —	H	H
Power To Arm —	1	1
Damage —	6	6
Shields Data:		
Deflector Shield Type —	FSF	FSF
Shield Point Ratio —	1/2	1/2
Maximum Shield Power —	8	8
Combat Efficiency:		
D —	62.9	88.9
WDF —	20.4	20.4

Notes:

Of the 374 *Thufir* Class destroyers built, 192 Mk Is and 136 Mk IIIs remain in active service, with 6 Mk Is in reserve fleets. Of the remainder, 1 Mk III is used by Star Fleet Training Command, 26 Mk Is and 8 Mk IIIs have been destroyed; 1 Mk III is listed as missing; 1 Mk I and 2 Mk IIIs have been scrapped; and 1 Mk I has been sold to civilian commercial concerns.

The *Thufir*, an Andorian design, is produced at the Morena and Salazaar shipyards at a combined rate of 15 per year.

Genser Class IV Escort

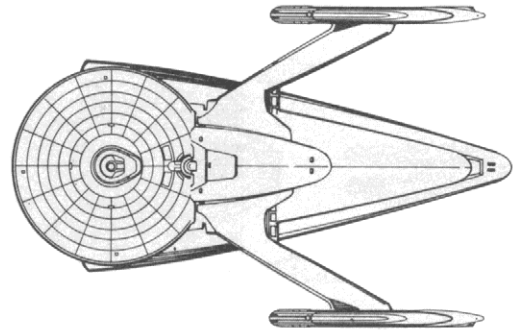
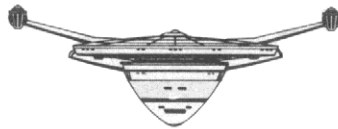
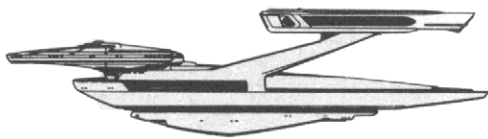

Construction Data:

Model Numbers —	MK I	MK II
Date Entering Service —	2/1712	2/2210
Number Constructed —	251	12

Hull Data:

Superstructure Points —	13	14
Damage Chart —	C	C
Size		
Length —	180 m	180 m
Width —	120 m	120 m
Height —	45 m	45 m
Weight —	33,200 mt	32,300 mt

Cargo

Cargo Units —	50 SCU	50 SCU
Cargo Capacity —	2,500 mt	2,500 mt
Landing Capability —	None	None

Equipment Data:

Control Computer Type —	M-1	M-1
Transporters —		
standard 6-person	2	2
emergency 22-person cargo	1	2
	1	1

Other Data:

Crew —	82	80
Passengers —	10	10
Shuttlecraft —	1	1

Engines And Power Data:

Total Power Units Available —	24	22
Movement Point Ratio —	3/1	2/1
Warp Engine Type —	FWH-1	FWA-2
Number —	2	2
Power Units Available —	10	8
Stress Charts —	Q/R	J/M
Maximum Safe Cruising Speed —	Warp 5	Warp 6
Emergency Speed —	Warp 6	Warp 8
Impulse Engine Type —	FIB-2	FIB-3
Power Units Available —	4	6

Weapons And Firing Data:

Beam Weapon Type —	FH-6	FH-7
Number —	8 in 4 banks	8 in 4 banks
Firing Arcs —	2fp, 2fs, 2pla, 2sla	2fp, 2fs, 2pla, 2sla
Firing Chart —	N	Q
Maximum Power —	3	4
Damage Modifiers —		
+2	(1 - 7)	(1 - 8)
+1	(8 - 13)	(9 - 15)

Shields Data:

Deflector Shield Type —	FSF	FSF
Shield Point Ratio —	1/2	1/2
Maximum Shield Power —	13	13

Combat Efficiency:

D —	59.6	70
WDF —	18.4	25.6

1096-64 1772

Notes:

The *Genser* Class escort is not only the newest ship in Materiel Command's fleet of escorts, it is also the smallest. Like all escorts, it is inexpensive to build, maintain, and operate. The *Genser* is even cheaper to build and operate than earlier escorts because of its size and design simplicity.

Because the maneuverability of the Mk I was unacceptable for escort duties, the design was modified and FWA-2 warp engines were installed on four test models before being approved for installation on all *Gensers*. In addition, the weapon systems were upgraded from the FH-6 to the FH-7 phaser, creating the Mk II. All *Genser* Class ships will be converted to this design no later than Stardate 2/2404.

On Stardate 2/1912, the *USS Genser*, along with five other escorts, was accompanying a convoy of neutronic fuel carriers to the rimward frontier when sensors scanned a small object travelling on a parallel course. The object could not be identified through computer search nor would it respond to any radio communications. The *Genser* broke away from the convoy to investigate the object and, as the other ships watched, disappeared. After several minutes, the *Genser* reappeared, maintaining its last course and speed, though it did not respond to radio calls; the small, mysterious object was nowhere to be found. Sensor scan revealed that the entire crew of the *Genser* had disappeared. The convoy was halted and searches were made, but nothing was found that would help solve the mystery. The connection between the unidentified object and the disappearance of the ship remains clouded in mystery and may never be solved. The *USS Genser* is on active duty and operates in the rimward frontier areas.

Of the 259 *Genser* Class escorts built, 226 Mk Is and 12 Mk IIs remain in active service. One Mk I is used by Star Fleet Training Command, 16 have been destroyed; 2 are listed as missing; 1 has been scrapped; and 14 have been sold.

The *Genser* is produced at the Cait facility at a rate of 30 per year.

Griffon Class VIII Escort

Construction Data:

Model Numbers —	MK I	MK II
Date Entering Service —	2/1503	2/2008
Number Constructed —	208	28

Hull Data:

Superstructure Points —	14	14
Damage Chart —	C	C
Size —		
Length —	220 m	220 m
Width —	85 m	85 m
Height —	40 m	40 m
Weight —	107,195 mt	107,450 mt

Cargo

Cargo Units —	50 SCU	50 SCU
Cargo Capacity —	2,500 mt	2,500 mt
Landing Capability —	None	None

Equipment Data:

Control Computer Type —	M 2	M 2
Transporters —		
standard 6 person	3	3
emergency 22 person	2	2
cargo	1	1

Other Data:

Crew —	146	148
Passengers —	10	10
Shuttlecraft —	2	2

Engines And Power Data:

Total Power Units Available —	34	34
Movement Point Ratio —	3/1	3/1
Warp Engine Type —	FWE-2	FWE-2
Number —	2	2
Power Units Available —	13	13
Stress Charts —	G/K	G/K
Maximum Safe Cruising Speed —	Warp 7	Warp 7
Emergency Speed —	Warp 9	Warp 9
Impulse Engine Type —	FIE-1	FIE-1
Power Units Available —	8	8

Weapons And Firing Data:

Beam Weapon Type —	FH-4	FH-4
Number —	4 in 2 banks	4 in 2 banks
Firing Arcs —	2Hp, 2Vs	2Hp, 2Vs
Firing Chart —	Q	Q
Maximum Power —	3	3
Damage Modifiers —		
+2	(1 - 8)	(1 - 8)
+1	(9 - 14)	(9 - 14)
Missile Weapon Type —	FP-2	FP-7
Number —	2	2
Firing Arcs —	1f, 1a	1f, 1a
Firing Chart —	H	R
Power To Arm —	1	1
Damage —	6	8

Shields Data:

Deflector Shield Type —	FSH	FSK
Shield Point Ratio —	1/2	1/2
Maximum Shield Power —	12	16

Combat Efficiency:

D —	66	72.0
WDF —	14.4	20.0

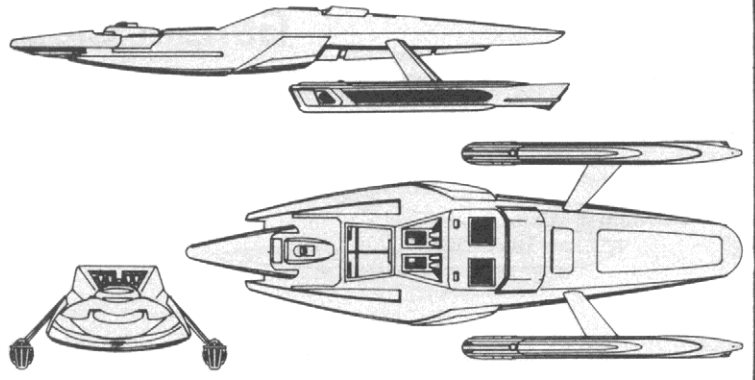

Notes:

Of the 236 *Griffon* Class escorts built, 177 Mk Is and 26 Mk IIs remain in active service, with 4 Mk Is in reserve fleets; 1 Mk II is used by Star Fleet Training Command; 20 Mk Is and 1 Mk II have been destroyed; 3 Mk IIs are listed as missing; 1 Mk I and 1 Mk II have been scrapped; and 2 Mk IIs have been sold to private commercial concerns.

The Mk I *Griffon* is no longer in production, but the Mk II is produced at the Morena facility at a rate of 24 per year.

9504 1440

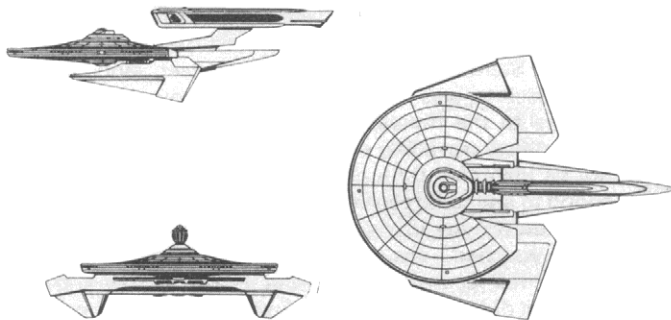

Notes:

Of the 861 *Remoras* built, 175 Mk IIs and 205 Mk IIIs remain in active service, with 280 Mk IIs and 12 Mk IIIs in reserve fleets. Eight Mk IIs are used by Star Fleet Training Command; 102 Mk IIs and 20 Mk IIIs have been destroyed; 3 Mk IIs have been captured by the Klingons. Twelve Mk IIs are listed as missing, and 2 are likely to have been captured by the Romulans; 28 Mk IIs and 2 Mk IIIs have been scrapped; and 12 Mk IIs and 2 Mk IIIs have been sold to private commercial concerns.

Production of the Mk II has been halted, but the Mk IIIs are being produced at Sol VI at a rate of 32 per year.

Remora Class VI-VII Escort

Construction Data:

Model Numbers —	MK II	MK III
Ship Class —	VI	VII
Date Entering Service —	2/0509	2/1601
Number Constructed —	620	241

Hull Data:

Superstructure Points —	12	18
Damage Chart —	C	C
Size —		
Length —	210 m	210 m
Width —	170 m	170 m
Height —	60 m	60 m
Weight —	78,200 mt	88,450 mt

Cargo

Cargo Units —	100 SCU	100 SCU
Cargo Capacity —	5,000 mt	5,000 mt
Landing Capability —	None	None

Equipment Data:

Control Computer Type —	M-2	M-2
Transporters —		
standard 6 person	3	3
emergency 22 person	2	2
cargo	1	1

Other Data:

Crew —	162	162
Passengers —	20	20
Troops —	20	20
Shuttlecraft —	None	1

Engines And Power Data:

Total Power Units Available —	22	28
Movement Point Ratio —	2/1	2/1
Warp Engine Type —	FWD-2	FWC-2
Number —	1	1
Power Units Available —	16	20
Stress Charts —	L/F	M/K
Maximum Safe Cruising Speed —	Warp 6	Warp 7
Emergency Speed —	Warp 8	Warp 9
Impulse Engine Type —	FIE-3	FIE-2
Power Units Available —	6	8

Weapons And Firing Data:

Beam Weapon Type —	FH-4	FH-4
Number —	8 in 4 banks	8 in 4 banks
Firing Arcs —	2Hp, 2p/a, 2Vs, 2s/a	2Hp, 2p/a, 2Vs, 2s/a
Firing Chart —	Q	Q
Maximum Power —	3	3
Damage Modifiers —		
+2	(1 - 8)	(1 - 8)
+1	(9 - 14)	(9 - 15)

Shields Data:

Deflector Shield Type —	FSF	FSH
Shield Point Ratio —	1/2	1/2
Maximum Shield Power —	10	13

Combat Efficiency:

D —	62.2	80
WDF —	20.8	20.8

1293.76 1664

Northampton Class X Frigate

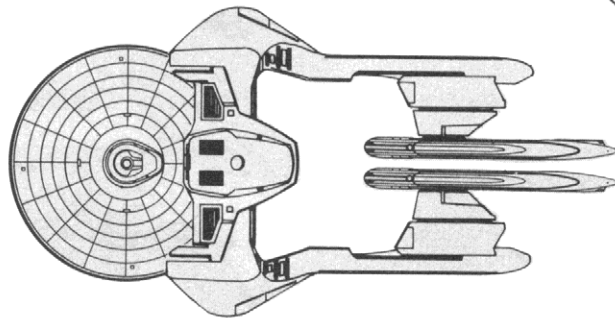
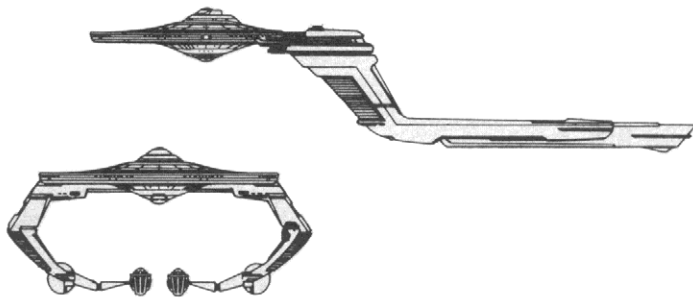

Construction Data:

Model Numbers —	MK I	MK III
Date Entering Service —	2/1905	2/2002
Number Constructed —	39	28

Hull Data:

Superstructure Points —	29	29
Damage Chart —	C	C
Size		
Length —	300 m	300 m
Width —	150 m	150 m
Height —	75 m	75 m
Weight —	154,600 mt	154,570 mt

Cargo

Cargo Units —	500 SCU	500 SCU
Cargo Capacity —	25,000 mt	25,000 mt
Landing Capability —	None	None

Equipment Data:

Control Computer Type —	M-6	M-6
Transporters —		
standard 6 person	6	6
combat 20-person	4	4
cargo	2	2

Other Data:

Crew —	325	328
Troops —	220	220
Shuttlecraft —	6	6

Engines And Power Data:

Total Power Units Available —	56	56
Movement Point Ratio —	4/1	4/1
Warp Engine Type —	FWG-1	FWG-1
Number —	2	2
Power Units Available —	26	26
Stress Charts —	D/F	D/F
Maximum Safe Cruising Speed —	Warp 8	Warp 8
Emergency Speed —	Warp 10	Warp 10
Impulse Engine Type —	FID-2	FID-2
Power Units Available —	4	4

Weapons And Firing Data:

Beam Weapon Type —	FH-11	FH-11
Number —	6 in 3 banks	6 in 3 banks
Firing Arcs —	2p/a, 2f, 2s/a	2p/a, 2f, 2s/a
Firing Chart —	Y	Y
Maximum Power —	10	10
Damage Modifiers —		
+3	(1 - 10)	(1 - 10)
+2	(11 - 17)	(11 - 17)
+1	(18 - 24)	(18 - 24)
Missile Weapon Type —	FP-7	FP-6
Number —	3	3
Firing Arcs —	3f	3f
Firing Chart —	R	O
Power To Arm —	1	1
Damage —	8	12

Shields Data:

Deflector Shield Type —	FSO	FSO
Shield Point Ratio —	1/3	1/3
Maximum Shield Power —	16	16

Combat Efficiency:

D —	124.0	124.0
WDF —	78.6	84.3

9740 + 104532

Notes:

The *Northampton* Class frigate, stationed by Star Fleet in all sensitive areas to prevent aggression, enjoys the respect and admiration of its crews and troops. These ships have numerous recreation facilities and spacious quarters for the crewmembers and marines. Swimming pools, grav-ball courts, and physical fitness centers are all located in the lower hull adjacent to the shuttlebay and near the engineering section.

The *Northampton* mounts the most powerful of Star Fleet's engines, the FWG-1 warp engine, which allows it to reach trouble spots quickly. Although the hull design incorporates the single-engine lock found on several Andorian designs, the *Northampton* is a Martian design.

The weapons array is similar to that found on the *Chandley* Class frigates, though the arrangement is not the same. Both classes mount 6 FH-11 phasers, but the fields of fire are quite different, with the *Northampton* having better aft-firing capabilities and the *Chandley* having better forward-firing capabilities. Unlike the *Chandley*, the *Northampton* has concentrated all three of its torpedo tubes forward, which makes it offensively powerful.

Reports on the exploits of the *USS Bremerton* while in the Triangle have made quite a stir in military circles. After spending one year in the Triangle conducting business of an undisclosed nature, the *Bremerton* returned to Starbase 10 and reported that it had encountered both Romulan and Klingon ships, all of which it was forced to fight. Details of the encounters are still classified.

Of the 67 *Northampton*s built, 66 remain in active service and 1 is used by Star Fleet Intelligence. The *Northampton* is produced at the Sol IV shipyards at a rate of 20 per year.

Chandley Class XI Frigate

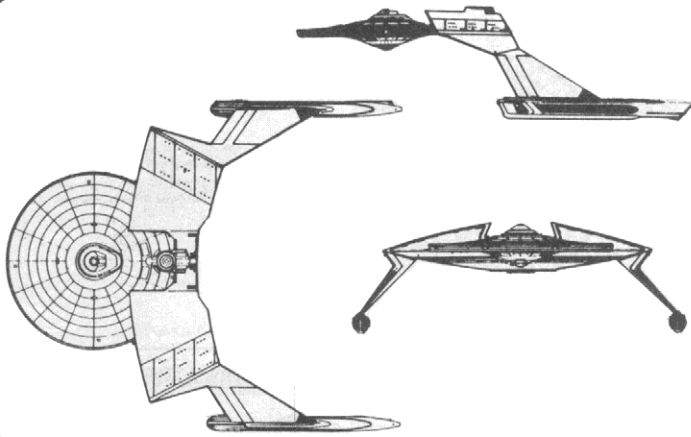

Notes:

After the conclusion of the Four Years War, Star Fleet Command initiated the *Strategic Forces Survey* to evaluate every major operation of the war, from its conception to its final outcome. All aspects of these operations, starting with the initial planning stages, to the deployment of forces, their use during the operation, and the after-action requirements of those forces, were evaluated. The results of this survey have directly influenced plans made by Star Fleet Command ever since.

One of the weaknesses identified by the survey was that Star Fleet needed combat vessels carrying boarding parties or prize crews so that it could follow up a successful campaign with rapid and decisive blows against a retreating or routed enemy. Star Fleet warships did not carry marine assault teams, and, therefore, they were unable to board and capture enemy vessels or outposts. In many operations, Star Fleet vessels were held back so that their combined boarding groups could take control of disabled enemy vessels or outposts; this caused lengthy delays in follow-up operations and allowed the enemy to recover. To take enemy outposts, assault ships were called in, frequently a poor choice because they were slow, vulnerable, and usually carried too many troops for small operations. To solve this problem, Star Fleet began developing the frigate class of ships to carry marines trained to board hostile vessels and complexes. Of the several different ships with this design, the most impressive is the *USS Chandley* Class frigate.

On Stardate 2/1612, the *USS Chandley*, the first of this prestigious line of vessels, was commissioned. The *Chandley* not only met the requirements of being a deep-space fighting vessel but also could beam its 250 marines in less than four minutes. With this vessel, Star Fleet had the ability to follow up combat more efficiently.

The *Chandley's* large, winglike assembly houses the company of marines, their equipment, training areas, shuttlebay, and the combat transporters needed. The marines are billeted by platoons, with each platoon having its own spacious training, mess, dormitory, and recreation areas. The training areas, located in the central core of the wing structures, are made up of modules that may be positioned to resemble the interior of enemy ships and installations, allowing assault teams to familiarize themselves with their intended operation area; this training technique is largely responsible for the high success rate in boarding actions. The training areas are also used for physical training and firing ranges. Each platoon has a recreation area containing a swimming pool, gymnasium, gravball chamber, and complete health facilities; these facilities are largely responsible for the notable successes enjoyed by marine sports teams.

Since its inception, the *Chandley* Class frigate has used the older FWC-1 warp drive system, an engine proven to be highly reliable. Though many ship designers have wanted to put newer, more powerful warp systems on the *Chandleys*, each time the power systems have been upgraded, it has been through improvements to the impulse drive system. Warp drives larger than the FWC-1 are more costly to run and maintain, an important factor that must be considered because of the relatively great expense required to keep a company of marines aboard.

Construction Data:

	MK I	MK III	MK IV
Model Numbers —	MK I	MK III	MK IV
Date Entering Service —	2/1612	2/1902	2/1912
Number Constructed —	84	64	48
Hull Data:			
Superstructure Points —	28	28	28
Damage Chart —	C	C	C
Size			
Length —	315 m	315 m	320 m
Width —	262 m	262 m	264 m
Height —	90 m	90 m	92 m
Weight —	173,300 mt	176,700 mt	177,500 mt
Cargo			
Cargo Units —	825 SCU	850 SCU	850 SCU
Cargo Capacity —	41,250 mt	42,500 mt	42,500 mt
Equipment Data:			
Control Computer Type —	M-6	M-6A	M-6A
Transporters —			
standard 6-person	8	8	8
combat 20-person	8	8	8
cargo	4	4	4
Other Data:			
Crew —	363	370	370
Passengers —	10	10	10
Troops —	250	250	250
Shuttlecraft —	12	12	12
Engines And Power Data:			
Total Power Units Available —	48	52	56
Movement Point Ratio —	3/1	3/1	3/1
Warp Engine Type —	FWC-1	FWC-1	FWC-1
Number —	2	2	2
Power Units Available —	16	16	16
Stress Charts —	Q/M	Q/M	Q/M
Maximum Safe Cruising Speed —	Warp 7	Warp 7	Warp 7
Emergency Speed —	Warp 9	Warp 9	Warp 9
Impulse Engine Type —	FIF-2	FIF-3	FIG-1
Power Units Available —	16	20	24
Weapons And Firing Data:			
Beam Weapon Type —	FH-11	FH-11	FH-11
Number —	6 in 3 banks	6 in 3 banks	6 in 3 banks
Firing Arcs —	21/p, 21, 21/s	21/p, 21, 21/s	21/p, 21, 21/s
Firing Chart —	Y	Y	Y
Maximum Power —	10	10	10
Damage Modifiers —			
+3	(1 - 10)	(1 - 10)	(1 - 10)
+2	(11 - 17)	(11 - 17)	(11 - 17)
+1	(18 - 24)	(18 - 24)	(18 - 24)
Missile Weapon Type —	FP-6	FP-5	FP-5
Number —	4	4	4
Firing Arcs —	2f, 2a	2f, 2a	2f, 2s
Firing Chart —	O	R	R
Power To Arm —	1	1	1
Damage —	12	16	16
Shields Data:			
Deflector Shield Type —	FSO	FSO	FSP
Shield Point Ratio —	1/3	1/3	1/4
Maximum Shield Power —	16	16	16
Combat Efficiency:			
D —	131.5	137.5	170
WDF —	91	102.2	102.2

11966-5 14082-5 17374

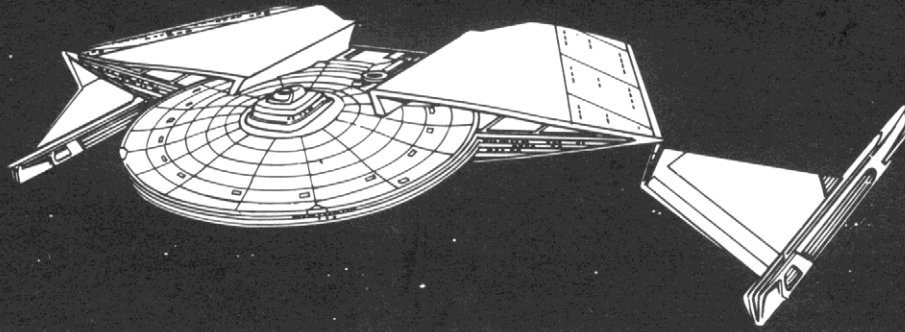

The *Chandley* Mk II design merely increased the size of the marines' storage cargo bays, but the Mk III changed the computer system, cargo bays, impulse drive system, and photon torpedo launchers. The computer was altered to the experimental M-6A for improved fire control, as the standard M-6 would not efficiently handle the increased capabilities of the FP-5 photon torpedo; the *Chandley* is the only class of ship in Star Fleet to possess this computer, as it has not been needed in other designs. The Mk IV design improved the shields; the earlier FSO shield generator was changed to the more efficient FSP. With this change, the *Chandley* Class frigate is one of the most powerful ships in known space. In all its modifications, it has gained a high level of respect from Romulan, Klingon, and Gorn commanders.

Historical Notes:

The *Chandley* is the only ship in Star Fleet named after the company that designed and built the class vessel. Actually, the company is owned by the descendants of Rear Admiral Thomas Chandley, one of the most-decorated naval heroes of Terran history. Chandley, an admiral in the U.S. Navy, is well known for his brilliant blockade of Soviet ports during the Aleutian Incident of 2003.

The first combat experience of any *Chandley* Class vessel was considered a total success. While patrolling in the Gorn Sector, the *USS Hanson* (NCC 2309), received a distress call from a commercial freighter stating it was under attack by unknown vessels. Upon reaching the coordinates given by the freighter, the *Hanson* encountered two Gorn cruisers involved in a boarding action against a *Liberty* Class freighter. When called upon to withdraw, the Gorn cruisers put up shields and opened fire. The *Hanson* made short work of the Gorn vessels, but the marine boarding parties found their task difficult at best, for they encountered Gorn marines who refused to give ground easily. Victory was won only after the Star Fleet marines gained access to the life support systems and shut them down. When the bridges of the Gorn vessels were entered, it was discovered that the entire bridge crew had committed suicide. Interrogation revealed that the ships had defected from the Gorn Alliance and were operating as renegades. The *Hanson's* marines sustained only three deaths and 17 casualties during this spirited action; all units involved received Commendations of Valor. This was the first time a Gorn ship had been boarded by Star Fleet personnel; much of the current knowledge about the Gorn Navy stems from this encounter.

In another incident, this one occurring Stardate 2/1910, the *USS Monson* (NCC 2392), on a fact-finding mission within the Triangle, was overtaken by four Klingon K-23 Class destroyers. At first, the Klingons merely scanned the *Monson* at a seemingly safe distance to its rear, but eventually two closed with the frigate, declared it had entered Klingon Imperial space, and demanded it heave to and prepare to be boarded. Finding himself well within the boundaries of the

Triangle, and realizing that the Klingon demands were the prelude to an unprovoked attack, the *Monson's* Captain immediately raised shields and warned the Klingons off. The Klingons attacked immediately, and the *Monson* returned fire. The *Monson's* aft torpedoes hit the bridge of the lead K-23, causing it to veer off course and into the path of the other oncoming vessels, whose fire crippled their comrade. Seeing this as an ill omen, the Klingons immediately departed the area, leaving the crippled ship behind. The *Monson* approached the Klingon, accepted its surrender, and beamed aboard two marine platoons before the Klingon ship exploded, killing all aboard. An after-action investigation revealed that an unidentified device in the engine room had been touched by an unsuspecting trooper, initiating a critical overload in the matter/anti-matter mix chamber. The explosion was of low yield and caused no damage to the *Monson*. The device that caused it has never been seen or reported since, and it is suspected by Star Fleet Intelligence to have been a jury-rigged self-destruct unit.

Because of this incident, Star Fleet policy states that before marines board any enemy vessel, a complete scan will be made of the vessel to determine if the destruct systems are in operation. Only if the scan results are negative will the boarding operation proceed. If the scan is positive, the enemy will be given the chance to disarm any such devices, and should they fail to do so promptly, the vessel is to be disabled and the crew subjected to intense phaser stun. Only then will engineers and UXB personnel beam aboard to disarm the device.

On Stardate 2/2005, one of the most-decorated frigates in Star Fleet, the *USS Blackheart* (NCC 2327), was reported missing while patrolling the Rimward Sector. A search was made, but all that was found was a communications buoy apparently discharged by the *Blackheart*. This buoy had only the partial message "...small object paralleling our course...no response on hailing freq..." The remainder of the tape was garbled, and portions had been intentionally erased. Star Fleet has no more information on the fate of the ship or its crew. The *Blackheart* is most remembered for the large black hearts painted on each of its lower wing assemblies; such painting is typical of *Chandley* Class ships, making them easily distinguished on visual scan. The practice is thought to keep the crew's pride in their vessel at a peak.

Of the 184 *Chandleys* built, 63 Mk Is, 64 Mk IIIs, and 47 Mk IVs remain in active service. Two Mk Is are used by Star Fleet Training Command; 4 Mk Is and 1 Mk IV have been destroyed; 1 Mk I is listed as missing; 1 Mk I has been scrapped, and 1 Mk I has been sold to the private sector.

The *Chandley* Class frigate is produced at the shipyards of Sol IV, Sol VI, and Andor at a rate of 4 Mk Is, 10 Mk IIIs, and 14 Mk IVs per year.

Loknar Class VIII-X Frigate

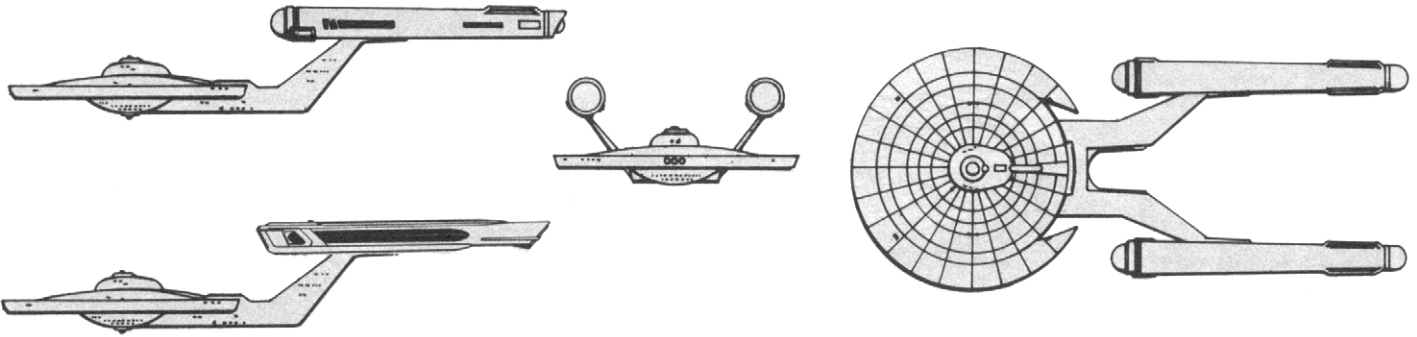

Construction Data:

	MK-I	MK II	MK IV	MK V
Model Numbers —	VII	VIII	IX	X
Ship Class —	VII	VIII	IX	X
Date Entering Service —	1/9010-1/9912	1/9801-2/1502	2/1308	2/1709
Number Constructed —	48	42	86	42
Hull Data:				
Superstructure Points —	14	18	21	24
Damage Chart —	C	C	C	C
Size				
Length —	290 m	290 m	290 m	290 m
Width —	127 m	127 m	127 m	127 m
Height —	56 m	56 m	56 m	56 m
Weight —	109,000 mt	115,800 mt	140,400 mt	145,975 mt
Cargo				
Cargo Units —	260 SCU	280 SCU	280 SCU	280 SCU
Cargo Capacity —	13,000 mt	14,000 mt	14,000 mt	14,000 mt
Landing Capability —	None	None	None	None
Equipment Data:				
Control Computer Type —	M-2	M-2	M-3	M-3
Transporters —				
standard 6-person	3	3	3	3
emergency 22-person	1	1	1	1
cargo	1	1	1	1
Other Data:				
Crew —	76	79	84	84
Passengers —	4	4	4	4
Shuttlecraft —	2	2	2	2
Engines And Power Data:				
Total Power Units Available —	19	29	39	42
Movement Point Ratio —	3/1	3/1	2/1	2/1
Warp Engine Type —				
Number —	2	2	2	2
Power Units Available —	8	13	18	18
Stress Charts —	LG	G/K	M/G	M/G
Maximum Safe Cruising Speed —	Warp 7	Warp 7	Warp 6	Warp 6
Emergency Speed —	Warp 9	Warp 9	Warp 8	Warp 8
Impulse Engine Type —				
Number —	3	3	3	6
Power Units Available —	-	-	-	-
Weapons And Firing Data:				
Beam Weapon Type —				
Number —	FL-4	FH-5	FH-5	FH-5
Firing Arcs —	4	8 in 4 banks	8 in 4 banks	8 in 4 banks
Firing Chart —	4p/1fs	2lp, 2fs, 4a	2lp, 2fs, 4a	2lp, 2fs, 4a
Maximum Power —	G	R	R	R
Damage Modifiers —	3	4	4	4
+2		(1 - 8)	(1 - 8)	(1 - 8)
+1	(1 - 4)	(9 - 16)	(9 - 16)	(9 - 16)
Missile Weapon Type —				
Number —	FAC-2	FP-3	FP-1	FP-6
Firing Arcs —	1	4	4	4
Firing Chart —	F	3f, 1a	3f, 1a	3f, 1a
Power To Arm —	G	D	L	O
Damage —	4	1	1	1
	10	6	10	12
Shields Data:				
Deflector Shield Type —	FSH	FSK	FSK	FSK
Shield Point Ratio —	1/2	1/2	1/2	1/2
Maximum Shield Power —	12	16	15	15
Combat Efficiency:				
D —	65.0	76.7	76.7	114.3
WDF —	5.4	29.6	42.4	51.6

The Loknar Class frigates were built during "The Great Awakening", a period of expansion by the Federation. During this time, many research and exploration vessels were designed and built to aid in the efforts to solidify an enlarged and growing United Federation of Planets. Also during this period, a smaller number of warships were built. The Loknar, the most noted of these warships, is still in service to this day, a tribute to the quality of the Andorian design.

Soon after the Federation Appropriations Committee granted Star Fleet the funds necessary to construct fleets to expand and patrol the limits of the UFP, Andorian factions began pushing for warship construction. The basic Andorian philosophy was that, in expanding, the Federation might come upon races as hostile as the Romulans and Klingons, leading to another protracted war broke out for which the Federation and Star Fleet were unprepared. The Andorians argued that, were this to happen or were the Klingons or Romulans to escalate hostilities, Star Fleet needed to be better prepared and would need ships to protect the new borders and colonies. The Andorian arguments were successful, and Star Fleet began a limited build-up of warships. Several shipbuilding facilities were constructed by Andorian firms to design and manufacture these warships, the most notable of these on Sol IV and Salazaar, the largest and most productive in the Federation.

Introduced on Stardate 1/9010, the Loknar Class frigate mounted the new, but already proven, FWE-1 warp drive, in Star Fleet's inventory for only two years. The FIC-2 impulse engine was introduced on the Loknar and has since proven itself to be one of the most reliable of all production. The Loknar Mk I was considered a 'muscle' ship because of its four heavy lasers and single accelerator cannon, making it equal to all but the largest Klingon vessels and more powerful than any ship in the Romulan navy. In addition, the Loknar mounted FSH shield generators, more efficient than any used by the enemies of the Federation.

During the Four Years War, the Loknar saw more action than any other vessel in Star Fleet. Although it was considered to be successful, the Andorian designers felt a need to improve it. The FWE-2 warp drive systems, still being tested, would produce 60% more power than the FWE-1 and would increase the ship's overall performance. The Mk II was commissioned into service on Stardate 1/9801 mounting the FWE-2, even though this engine was not officially adopted by Star Fleet until Stardate 2/0002.

The most significant advance in starship technology came with the phaser and photon torpedo. The phaser delivers more firepower at longer ranges, weighs less, and requires less structural reinforcing than the laser. The newly developed photon torpedo delivered the same explosive power at 75% less power requirement, was considerably

351 2270-32 3252.08 589788

lighter, and required less structural reinforcement than the accelerator cannon. Eight FH-5 phasers and four FP-3 torpedoes were incorporated into the Mk II, making it more powerful than anything in the Klingon fleet with the exception of the D-10. The Mk II also mounted an upgraded binary shield generator, the FSK, giving 33% more protection at the same output level as the earlier system.

The next major change in the *Loknar's* design came with the introduction of the FWD-2 warp drive to the Mk IV. This increased the power output and overall performance by 40%. Furthermore, this model was modified to fire the FP-1 torpedo.

The Mk V is the latest model of the *Loknar* Class. This version mounts the FIC-3 impulse engine and FP-6 torpedoes.

Loknar Class frigates have served Star Fleet faithfully for 33 years and will remain in the inventory for many years to come. *Loknars* are produced at the Salazaar and Sol VI facilities at a rate of 2 ships per year, including refits. The current production rate is low due to the number of ships required and the high levels of reliability in existing ships.

Historical Notes:

The *Loknar* Class frigates are named after cities and provinces of the Federation. More than half of these vessels are crewed by Andorians and the majority of these are assigned to the 'Blue Fleet', ships whose officer contingent and crew are entirely Andorian. The *USS Loknar* was the first ship commissioned into the Blue Fleet, serving as the flagship for many years.

The infamous *IKSV Staa'v'eMara* (Slave Of Justice), was originally the *USS Morgan City*, a *Loknar* Class frigate captured by Admiral Kamato's forces during the Four Years War and later used in Kamato's abortive coup attempt on the Klingon throne. After failing, Kamato retreated into the Triangle, taking the *Loknar* Class frigate with him. From their location in the Triangle, the Klingon rebels began attacking unprotected convoys and merchant vessels by using the *Staa'v'eMara* to lure them in. This ruse lasted for several years, then a general recall of all *Loknar* Class vessels made it difficult for the Klingon vessel to operate as though it were from Star Fleet. The IKS Admiralty then decided to have the vessel painted in the standard steel-gray color of their Navy. The *Staa'v'eMara* still operates with the IKS Navy and has been seen as recently as Stardate 2/2301.

Disposition

The following list of *Loknar* Class frigates shows their hull numbers, name, model designation, date entering service, and current disposition. The disposition is represented by the letter codes given below and is followed by the date of occurrence.

I	Inactive	L	Lost, whereabouts unknown.
D	Destroyed	R2	Refit to Mk II
CK	Captured in Four Years War	R4	Refit to Mk IV
DK	Destroyed in Four Years War	R5	Refit to Mk V
Sc	Scrapped	T	Used by Training Command

NCC 2700	Loknar	I	1/9010, R2 1/9807, R4 2/1406	NCC 2751	Izar	II	1/9802, R4 2/1501, R5 2/2002
NCC 2701	Ahkeil	I	1/9011, R2 1/9901, 12/1502	NCC 2752	Titan	II	1/9802, R4 2/1402, R5 2/1810
NCC 2702	Vernol	I	1/9101, DK 1/9412	NCC 2753	Rhea	II	1/9809, R4 2/1312
NCC 2703	Trantis	I	1/9104, R2 1/9810, 12/1502	NCC 2754	Helios	II	1/9811, 12/1410
NCC 2704	Morgan City	I	1/9107, CK 1/9409	NCC 2755	Capor Bana	II	1/9906, D 2/0305
NCC 2705	Farside	I	1/9201, R2 9906, 12/1508	NCC 2756	Houston	II	2/0003, R4 2/1403, R5 2/1710
NCC 2706	New America	I	1/9205, R2 2/0012, R4 2/1410	NCC 2757	Rio De Janiero	II	2/0102, R4 2/1312, R5 2/1906
NCC 2708	Kosk	I	1/9206, Sc 2/0012	NCC 2758	Lavinius	II	2/0111, L 2/0902
NCC 2709	Borga	I	1/9212, DK 1/9506	NCC 2759	Dallas	II	2/0301, R4 2/1408, R5 2/2110
NCC 2710	Peking	I	1/9304, R2 1/9804, Sc 2/1411	NCC 2760	Iriia	II	2/0401, R4 2/1310, R5 2/2006
NCC 2711	Epcot	I	1/9306, R2 1/9812, R4 2/1406, R5 2/1808	NCC 2761	Karrik Al Van	II	2/0406, R4 2/1404, R5 2/1802
NCC 2712	Aldebaran	I	1/9310, R2 1/9904, D 2/0802	NCC 2762	Thefel	II	2/0603, R4 2/1408, R5 1712
NCC 2713	Proxima	I	1/9310, L 1/9711	NCC 2763	Ptarth	II	2/0712, 12/1502
NCC 2714	Antares	I	1/9402, Sc 2/0012	NCC 2764	Alpha Colony	II	2/0906, D 2/1408
NCC 2715	Argus City	I	1/9406, DK 1/9510	NCC 2765	Altair VI	II	2/1004, R4 2/1402
NCC 2716	New York	I	1/9409, DK 1/9510	NCC 2766	Ariannus	III	2/1212, R4 2/1502, R5 2/2001
NCC 2717	Boridi	I	1/9501, DK 1/9610	NCC 2767	Cairo	II	2/1308, R5 2/1806
NCC 2718	Moscow	I	1/9504, R2 1/9803, R4 2/1312	NCC 2768	Coridan	IV	2/1308, R5 2/2006
NCC 2719	Tokyo	I	1/9508, D 1/9801	NCC 2769	Cygni Minor	IV	2/1312, R5 2/1901
NCC 2720	Corinth IV	I	1/9508, DL 1/9611	NCC 2770	Drox	IV	2/1402, R5 2/2101
NCC 2721	Daran V	I	1/9511, R2 1/9804, R4 2/1402	NCC 2771	Toronto	IV	2/1405, R5 2/2202
NCC 2722	Paris	I	1/9601, R2 2/0006, 12/1011	NCC 2772	Trifis	IV	2/1407, R5 2/1805
NCC 2723	Elas	I	1/9603, DK 1/9701	NCC 2773	Bondorant	IV	2/1410
NCC 2724	Troyius	I	1/9606, R2 2/0001, 12/1410	NCC 2774	Garros	IV	2/1410, R5 2/1712
NCC 2726	Rome	I	1/9609, R2 1/9804, R4 2/1501, D 2/1803	NCC 2775	Janus Colony	IV	2/1501, D 2/2201
NCC 2727	Los Angeles	I	1/9609, DK 1/9701	NCC 2776	Iotia	IV	2/1412, R5 2/1910
NCC 2728	Ekos	I	1/9611, R2 1/9904, 12/1410	NCC 2777	Tryla	IV	2/1502, R5 2/2007
NCC 2729	Yonada	I	1/9611, DK 1/9704	NCC 2778	Vladivostok	IV	2/1503, R5 2/1911
NCC 2730	Makusia	I	1/9611, DK 1/9709	NCC 2779	Noma Ra Den	IV	2/1503, L 2/1902
NCC 2731	Berlin	I	1/9701, R2 1/9806, D 2/1203	NCC 2780	New Delphi	IV	2/1502, R5 2/1808
NCC 2732	Opkapi	I	1/9702, R2 9802, 12/1410	NCC 2781	Salos	IV	2/1508, R5 2/1910
NCC 2733	Aurelia	I	1/9705, DK 1/9712	NCC 2782	Thuphylla	IV	2/1511, R5 2/1902
NCC 2734	Carinae II	I	1/9705, DK 1/9801	NCC 2783	Molens	IV	2/1601, R5 2/2103
NCC 2735	Antos IV	I	1/9706, R2 2/0002	NCC 2784	Mantilles	IV	2/1606, R5 2/2202
NCC 2736	Arcannis	I	1/9706, DK 1/9711	NCC 2785	Sogon	IV	2/1610, R5 2/1710
NCC 2737	Mordensia	I	1/9706, R2 1/9901, 12/1502	NCC 2786	Phobos	IV	2/1701, R5 2/2204
NCC 2738	Chicago	I	1/9708, R2 2/0008, 12/1410	NCC 2787	Luna	IV	2/1709, R5 2/2006
NCC 2739	Deneb Clar	I	1/9709, DK 9801	NCC 2788	Johannesburg	IV	2/1709, R5 2/1812
NCC 2740	Gaikos	I	1/9710, L 1/9903	NCC 2789	Stockholm	IV	2/1803, R5 2/1909
NCC 2741	Sydney	I	1/9711, R2 1/9802, D 2/0505	NCC 2790	Fall Den	IV	2/1810
NCC 2742	Halk	I	1/9712, R2 1/9804, R4 2/1312, D 2/1803	NCC 2791	Que Dane	IV	2/1904, R5 2/2011
NCC 2743	Ilyra	I	1/9712, R2 1/9804, 12/1410	NCC 2793	Jezar	V	2/1709
NCC 2744	Mjorn	I	1/9801, R2 1/9804, R4 2/1406, R5 2/1803	NCC 2794	Hobbiton	V	2/1806
NCC 2745	Alondra	I	1/9801, DK 1/9805	NCC 2795	Hong Kong	V	2/1811
NCC 2746	Carinae V	I	1/9803, R2 1/9812, 12/1502	NCC 2796	Caitos Prea	V	2/1903
NCC 2747	Argelia	I	1/9803, D 2/0004	NCC 2797	Mulandra	V	2/1905
NCC 2748	Lactra	II	1/9801, 12/1502	NCC 2798	Kism	V	2/1910
NCC 2749	London	II	1/9801, R4 2/1312, R5 2/1810	NCC 2799	Tog	V	2/2004
NCC 2750	Deneva Ra	II	1/9801, R4 2/1412, R5 2/1901				

Babcock Class XI Frigate

Construction Data:

Model Numbers —	MK II	MK V
Date Entering Service —	2/1709	2/2002
Number Constructed —	92	48

Hull Data:

Superstructure Points —	24	26
Damage Chart —	C	C
Size —		
Length —	355 m	355 m
Width —	150 m	150 m
Height —	60 m	60 m
Weight —	170,900 mt	173,750 mt

Cargo

Cargo Units —	600 SCU	600 SCU
Cargo Capacity —	30,000 mt	30,000 mt

Equipment Data:

Control Computer Type —	M-4	M-4
Transporters —		
standard 6 person	8	8
combat 20 person	8	8
cargo	3	3

Other Data:

Crew —	360	368
Passengers —	10	10
Troops —	250	250
Shuttlecraft —	8	8

Engines And Power Data:

Total Power Units Available —	46	46
Movement Point Ratio —	4/1	4/1
Warp Engine Type —	FWF-1	FWF-1
Number —	2	2
Power Units Available —	20	20
Stress Charts —	G/L	G/L
Maximum Safe Cruising Speed —	Warp 6	Warp 6
Emergency Speed —	Warp 8	Warp 8
Impulse Engine Type —	FIC-3	FIC-3
Power Units Available —	6	6

Weapons And Firing Data:

Beam Weapon Type —	FH-3	FH-9
Number —	6 in 3 banks	6 in 3 banks
Firing Arcs —	2fp, 2l, 2fs	2fp, 2l, 2fs
Firing Chart —	W	X
Maximum Power —	5	6
Damage Modifiers —		
+3	(1 - 10)	
+2	(11 - 17)	(1 - 12)
+1	(18 - 20)	(13 - 22)
Missile Weapon Type —	FP-6	FP-6
Number —	2	2
Firing Arcs —	1f, 1a	1f, 1a
Firing Chart —	0	0
Power To Arm —	1	1
Damage —	12	12

Shields Data:

Deflector Shield Type —	FSP	FSP
Shield Point Ratio —	1/4	1/4
Maximum Shield Power —	16	16

Combat Efficiency:

D —	130.3	133.2
WDF —	48.2	49.4

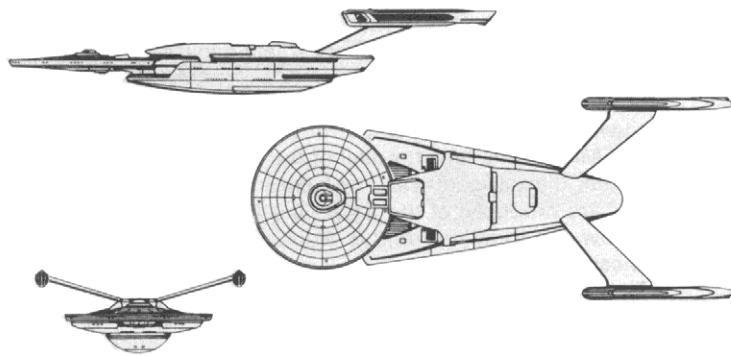

Notes:

Of the 140 Babcock Class frigates built, 84 Mk IIs and all 48 Vs remain in active service. One Mk II is used by Star Fleet Training Command, 6 Mk IIs have been destroyed, and 1 Mk II is listed as missing.

The Babcock is manufactured at the Morena and Merak facilities at a combined rate of 16 per year.

6280-5 6580-08

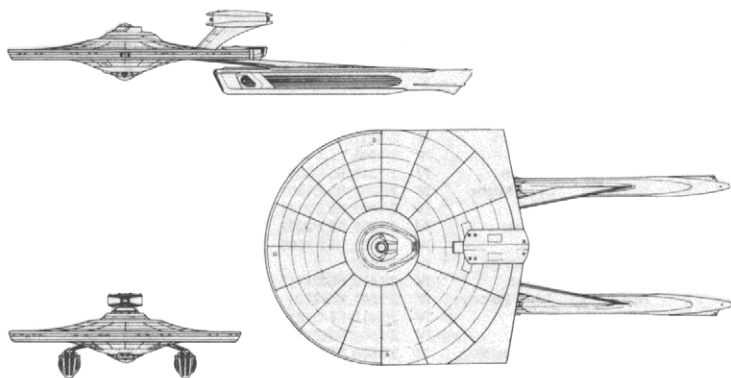

Notes:

Of the 84 Kiev Class frigates built, 68 remain in active service, 1 is used by Star Fleet Training Command; 12 have been destroyed; 1 is listed as missing; and 2 have been scrapped.

The Kiev is produced at the Salazaar and Merak shipyards at a combined rate of 14 per year.

Kiev Class XI Frigate

Construction Data:

Model Numbers —	MK I
Date Entering Service —	2/1610
Number Constructed —	84

Hull Data:

Superstructure Points —	24
Damage Chart —	C
Size —	
Length —	280 m
Width —	140 m
Height —	50 m
Weight —	165,200 mt

Cargo

Cargo Units —	150 SCU
Cargo Capacity —	7,500 mt
Landing Capability —	None

Equipment Data:

Control Computer Type —	M-3
Transporters —	
standard 6 person	4
combat 20 person	3
cargo	2

Other Data:

Crew —	300
Troops —	120
Shuttlecraft —	4

Engines And Power Data:

Total Power Units Available —	44
Movement Point Ratio —	3/1
Warp Engine Type —	FWC-1
Number —	2
Power Units Available —	16
Stress Charts —	O/M
Maximum Safe Cruising Speed —	Warp 7
Emergency Speed —	Warp 9
Impulse Engine Type —	FIF-1
Power Units Available —	12

Weapons And Firing Data:

Beam Weapon Type —	FH-8
Number —	6 in 3 banks
Firing Arcs —	2fp, 2fs, 2a
Firing Chart —	T
Maximum Power —	5
Damage Modifiers —	
+2	(1 - 10)
+1	(11 - 18)
Missile Weapon Type —	FP-4
Number —	2
Firing Arcs —	1f, 1a
Firing Chart —	S
Power To Arm —	1
Damage —	20

Shields Data:

Deflector Shield Type —	FSL
Shield Point Ratio —	1/3
Maximum Shield Power —	14

Combat Efficiency:

D —	119.8
WDF —	50.0

Fenlon Class V Monitor

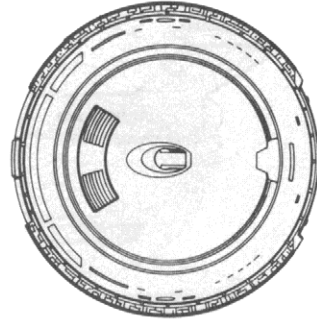
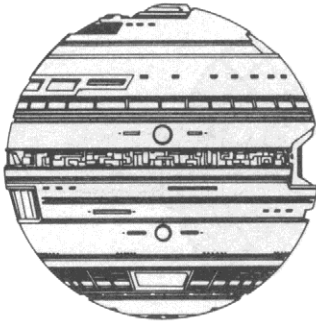

Construction Data:

Model Numbers —	MK II	MK IV
Date Entering Service —	1/9701-2/1512	2/1010
Number Constructed —	620	587

Hull Data:

Superstructure Points —	14	14
Damage Chart —	C	C
Size		
Length —	120 m	120 m
Width —	120 m	120 m
Height —	120 m	120 m
Weight —	48,080 mt	48,335 mt

Cargo

Cargo Units —	100 SCU	100 SCU
Cargo Capacity —	5,000 mt	5,000 mt
Landing Capability —	None	None

Equipment Data:

Control Computer Type —	M-1	M-1
Transporters —		
standard 6-person	3	3
combat 20-person	1	1
emergency 22-person	1	1
cargo	1	1

Other Data:

Crew —	72	76
Pasengers —	20	20
Troops —	20	20
Shuttlecraft —	6	6

Engines And Power Data:

Total Power Units Available —	27	30
Movement Point Ratio —	2/1	2/1
Warp Engine Type —	FSLB	FSLB
Number —	2	2
Power Units Available —	12	12
Stress Charts —	L/P	L/P
Impulse Engine Type —	FIC-2	FIB-3
Power Units Available —	3	6

Weapons And Firing Data:

Beam Weapon Type —	FH-2	FH-4
Number —	10 in 5 banks	10 in 5 banks
Firing Arcs —	2f, 4p, 4s	2f, 4p, 4s
Firing Chart —	H	N
Maximum Power —	3	3
Damage Modifiers —		
+2		(1 - 8)
+1	(1 - 10)	(9 - 14)

Shields Data:

Deflector Shield Type —	FSD	F5F
Shield Point Ratio —	1/2	1/2
Maximum Shield Power —	8	12

Combat Efficiency:

D —	69.0	79.0
WDF —	13	26.0



Notes:

The *Fenlon* is the only monitor class in Star Fleet. Because ships of the monitor type generally are used to patrol and maintain order over subjugated worlds, the UFP has little need for a vessel of this type, except near the borders. These ships patrol border systems and protect them from marauders and pirates.

The spherical hull design is a drastic departure from normal Star Fleet designs. The engines are mounted centrally and are difficult to locate on a visual scan. The sub-light drive system is capable of moving the *Fenlons* at .9 warp for periods of up to 6 months. Of course, being stationed in-system or at a border outpost because their limited top speed limits their range, the monitors will seldom need this capability because they are always near their supply depots.

The *Fenlon* Class monitor is seldom found alone. Its primary function is to support the cutters that are operating in the area. It will act as a heavy support vessel when the cutters have encountered a ship that they cannot deal with alone. The *Fenlon*, with its 10 phasers, is an unwelcome sight to smugglers, pirates, and marauders.

Of the 876 *Fenlons* built, 334 Mk IIs and 130 Mk IVs remain in active service, with 110 Mk IIs and 42 Mk IVs in reserve fleets. One of each type is used by Star Fleet Training Command; 132 Mk IIs and 68 Mk IVs have been destroyed; 4 Mk IIs and 2 Mk IVs are listed as missing; 39 Mk IIs and 8 Mk IVs have been scrapped; and 4 Mk IIs and 1 Mk IV have been sold to private commercial concerns.

The *Fenlon* is produced at the Alpha Centauri shipyards at a rate of 2 per year.

Nelson Class VII Scout

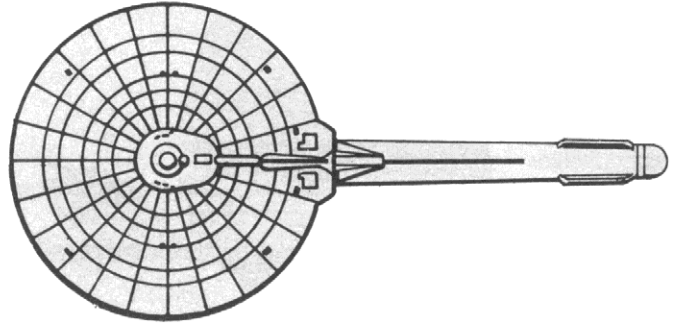
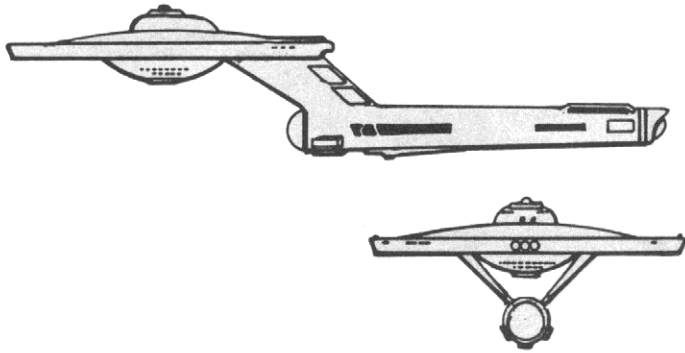

Construction Data:

	MK I	MK II	MK V	MK VII
Model Numbers —	1/8804-2/0006	1/9702-2/1010	2/0806-2/1811	2/1602
Date Entering Service —				
Number Constructed —	84	118	114	112
Hull Data:				
Superstructure Points —	10	11	12	13
Damage Chart —	C	C	C	C
Size				
Length —	263 m	263 m	263 m	270 m
Width —	127 m	127 m	127 m	127 m
Height —	61 m	61 m	61 m	61 m
Weight —	79,700 mt	80,600 mt	82,300 mt	85,600 mt
Cargo				
Cargo Units —	45 SCU	45 SCU	45 SCU	45 SCU
Cargo Capacity —	2,250 mt	2,250 mt	2,250 mt	2,250 mt
Landing Capability —	None	None	None	None
Equipment Data:				
Control Computer Type —	M-1	M-1	M-1	M-2
Transporters —				
standard 6-person	3	3	3	3
emergency 22-person cargo	2	2	2	2
	1	1	1	1
Other Data:				
Crew —	176	180	184	190
Passengers —	10	10	10	10
Shuttlecraft —	1	1	1	1
Engines And Power Data:				
Total Power Units Available —	18	20	26	28
Movement Point Ratio —	3/1	3/1	2/1	2/1
Warp Engine Type —				
Number —	1	1	1	1
Power Units Available —	14	14	20	20
Stress Charts —	N/L	N/L	M/K	M/K
Maximum Safe Cruising Speed —	Warp 8	Warp 8	Warp 7	Warp 7
Emergency Speed —	Warp 10	Warp 10	Warp 9	Warp 9
Impulse Engine Type —				
Power Units Available —	4	6	6	8
Weapons And Firing Data:				
Beam Weapon Type —				
Number —	FL-3	FH-2	FH-7	FH-8
Firing Arcs —	2	2	2	3, 2 in 1 bank
Firing Chart —	f	p/f/s	p/f/s	2f/p/s, 1a
Maximum Power —	G	H	Q	T
Damage Modifiers —	2	3	4	5
+2			(1 - 8)	(1 - 10)
+1	(1 - 4)	(1 - 10)	(9 - 14)	(11 - 18)
Shields Data:				
Deflector Shield Type —	FSG	FSF	FSH	FSN
Shield Point Ratio —	1/1	1/2	1/2	1/2
Maximum Shield Power —	10	10	13	16
Combat Efficiency:				
D —	37.3	49.8	73.2	82.6
WDF —	1.4	2.6	6.4	12.9

engine and was capable of cruising at Warp 8 for up to two years at a time. The Mk I was not particularly maneuverable and relied on its emergency speed of Warp 10 to carry it to safety if it were attacked. Because of its mission, the Mk I mounted two forward-firing only, medium-power lasers, and the FSG shield generator, a single transducer system.

When phaser weapons were brought into the inventory, the Mk Is were refit as they returned from their missions. At this same time, the impulse engines were replaced with the FIC-3 system, increasing the power output by 10%. Experiences during the Four Years War dictated an upgrade to the FSF shield generator, its binary transducer giving the same protection at half the power expenditure. By Stardate 2/0006 all Mk Is had been refit to Mk IIs.

On Stardate 2/0801 Star Fleet passed down the order to refit the Mk II vessels to the Mk III by installing FWC-2 warp engines, FH-7 phasers, and FSH shield generators. The change in the main engines would increase the overall power output by 30% and the maneuverability by 50% at the expense of the cruising and emergency speeds. FSH shield generators were installed for more protection, and, as an added defensive element, FH-7 phasers replaced the FH-2s. On Stardate 2/0806 the first of the refit *Nelsons*, the *USS Sager*, was put into service. In all, 114 of the Mk IIIs would be commissioned before the introduction of the Mk V.

The Mk IV mounted the FIE-2 impulse drive system. Only two of this model, the *USS Moisanen* and *USS Manzer*, ever entered service. Prior to their completion, the Mk IV design was changed and all other vessels under construction were altered to conform to this change. The *Moisanen* and *Manzer* were refit to the Mk V model within two years after their entry into service.

The Mk V mounted the FH-8 phaser system and the FSN shield generators. A major change in the arrangement of the weapons was incorporated in the Mk V. The earlier models mounted two phasers with separate fire control systems, which meant that both could be fired independently but they required more space and operating personnel. In the Mk V, the phasers were put into a bank and a single phaser was added to cover the aft quadrant. The FH-8s, being more sophisticated and having a longer range, required the M-2 computer system. The FSN shield generators increased the shielding protection by 20%.

Of the 273 *Nelsons* built, 88 Mk Vs remain in active service, with 14 Mk IIs, 12 Mk IIIs, and 8 Mk Vs in reserve fleets. One Mk V is used by Star Fleet Training Command, and 32 Mk Is, 11 Mk IIs, 8 Mk IIIs, and 3 Mk Vs have been destroyed. Four Mk Is were captured by the Klingons during the Four Years War; 16 Mk Is, 6 Mk IIs, 2 Mk IIIs, and 1 Mk V have been listed as missing; 8 Mk Is, 10 Mk IIs, 22 Mk IIIs, and 9 Mk Vs have been scrapped; and 4 Mk Is, 4 Mk IIs, 8 Mk IIIs, and 2 Mk Vs have been sold to civilian commercial concerns.

"The Great Awakening" was responsible for the addition of many ships to Star Fleet, not the least of which was the *Nelson* Class scout. This vessel shares many design features with the *Constitution* Class cruisers and the *Larson* Class destroyers, though it is not intended to act as a warship. The primary mission of the *Nelson* is to explore and map uncharted areas of space, to observe new civilizations and cultures, and, in some cases, to make initial contact. This has made the *Nelson* Class scout responsible for more contacts with alien cultures than any other vessel class in Star Fleet.

When introduced on Stardate 1/8804, the *Nelson* was the most modern vessel in the Galaxy Exploration Command; it would prove to be one of the finest ships of its day. It mounted the powerful FWC-1 warp

Bader Class VIII Scout

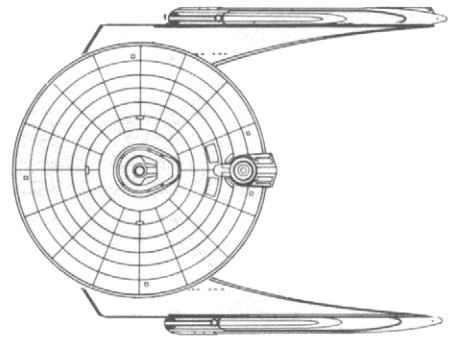
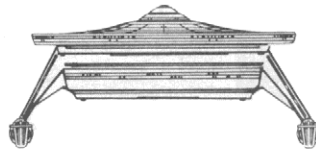
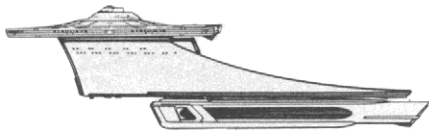

BADER CLASS VIII SCOUT

Construction Data:

Model Numbers —	MK I	MK II	MK V
Date Entering Service —	2/1208-2 2004	2/1410	2/2202
Number Constructed —	81	135	16

Hull Data:

Superstructure Points —	16	16	16
Damage Chart —	C	C	C
Size			
Length —	232 m	232 m	232 m
Width —	180 m	180 m	180 m
Height —	80 m	80 m	80 m
Weight —	109,920 mt	110,100 mt	109,900 mt

Cargo

Cargo Units —	510 SCU	600 SCU	600 SCU
Cargo Capacity —	25,500 mt	30,000 mt	30,000 mt
Landing Capability —	None	None	None

Equipment Data:

Control Computer Type —	M-2	M-2	M-2
Transporters —			
standard 6-person	3	3	3
emergency 22-person	2	2	2
cargo - small	2	2	2
large	1	1	1

Other Data:

Crew —	160	166	166
Passengers —	30	30	30
Shuttlecraft —	4	4	4

Engines And Power Data:

Total Power Units Available —	30	34	38
Movement Point Ratio —	3/1	3/1	3/1
Warp Engine Type —	FWE-2	FWE-2	FWE-2
Number —	2	2	2
Power Units Available —	13	13	13
Stress Charts —	G/K	G/K	G/K
Maximum Safe Cruising Speed —	Warp 7	Warp 7	Warp 7
Emergency Speed —	Warp 9	Warp 9	Warp 9
Impulse Engine Type —	FID-2	FIE-2	FIF-2
Power Units Available —	4	8	12

Weapons And Firing Data:

Beam Weapon Type —	FH-4	FH-7	FH-12
Number —	4 in 2 banks	4 in 2 banks	4 in 2 banks
Firing Arcs —	2fp, 2fs	2fp, 2fs	2fp, 2fs
Firing Chart —	Q	Q	R
Maximum Power —	3	4	6
Damage Modifiers —			
+2	(1 - 8)	(1 - 8)	(1 - 9)
+1	(9 - 14)	(9 - 14)	(10 - 16)

Shields Data:

Deflector Shield Type —	FSH	FSH	FSH
Shield Point Ratio —	1/2	1/2	1/2
Maximum Shield Power —	12	12	12

Combat Efficiency:

D —	68.9	72.9	76.9
WDF —	10.2	12.8	19.9

702-78 759-12 1530-31



Notes:

Shortly after the Organian Treaty had been imposed, Star Fleet began a buildup of its research ships. Contracts were let out for ships with limited combat ability and extensive research facilities. The most famous of those commissioned was the *Bader*. Although classified and armed as a scout because of its military role, it was in all respects a research vessel. The research facilities aboard the *Bader* were the most extensive of any on a Star Fleet vessel until the *Gagarin* Class research vessel entered service.

The *USS Bader*, *USS Clifton*, and *USS Tombaugh* are the research vessels awarded to the winner of the coveted Sagan Award for research contributing to the advancement of Federation science. Every year, each of the three research teams that win the award is given one of these vessels for two years, fully equipped to perform whatever studies and research the teams wish. This has made the *Bader* Class a popular and easily-recognized vessel throughout the scientific community.

In its military role, the *Bader* is not quite as exciting. The warp engines are not as efficient as those mounted on other scouts, and the vessels are not as maneuverable. Due to the displacement of the *Bader*, this deficiency cannot be corrected. Attempts have been made to increase the impulse drive power, but even this has not brought the performance level up to that of other scouts. Furthermore, compared to other scout vessels, the *Bader* is undergunned, mounting only 4 phasers. The *Bader* is the only modern scout that does not mount photon torpedo tubes. For these reasons, the *Bader* is not popular among the crews assigned to the borders of the other major powers.

Of the 164 *Baders* built, 117 Mk IIs and 15 Vs remain in active service, with 4 Mk IIs in reserve fleets. Five Mk Is, 6 Mk IIs, and 1 Mk V have been destroyed; 4 Mk Is and 2 Mk IIs are listed as missing; 2 Mk IIs have been scrapped; and 4 Mk Is and 2 Mk IIs have been sold to private commercial concerns.

The *Bader* is produced at the Sol V shipyards at a combined rate of 4 per year.

Keith Class VI Scout

Construction Data:		
Model Numbers —	MK I	MK III
Date Entering Service —	2/0405-2/2001	2/1603
Number Constructed —	172	61
Hull Data:		
Superstructure Points —	14	15
Damage Chart —	C	C
Size:		
Length —	180 m	180 m
Width —	80 m	80 m
Height —	80 m	80 m
Weight —	61,595 mt	63,535 mt
Cargo:		
Cargo Units —	400 SCU	400 SCU
Cargo Capacity —	20,000 mt	20,000 mt
Landing Capability —	None	None
Equipment Data:		
Control Computer Type —	M-1	M-1
Transporters —		
standard 6 person	3	3
emergency 22 person	1	1
cargo - small	2	2
large	1	1
Other Data:		
Crew —	96	100
Troops —	20	20
Shuttlecraft —	2	2
Engines And Power Data:		
Total Power Units Available —	30	34
Movement Point Ratio —	2/1	2/1
Warp Engine Type —		
Number —	FWB-2	FWB-2
Power Units Available —	2	2
Stress Charts —	14	14
Impulse Engine Type —	M/O	M/O
Power Units Available —	FIB-1	FIB-3
	2	6
Weapons And Firing Data:		
Beam Weapon Type —		
Number —	FH-6	FH-4
Firing Arcs —	4 in 2 banks	4 in 2 banks
Firing Chart —	2Wp, 2Ws	2Wp, 2Ws
Maximum Power —	N	Q
Damage Modifiers —	3	3
+2	(1 - 7)	(1 - 8)
+1	(8 - 13)	(9 - 14)
Missile Weapon Type —		
Number —	FP-2	FP-1
Firing Arcs —	1	1
Firing Chart —	H	L
Power To Arm —	1	1
Damage —	6	10
Shields Data:		
Deflector Shield Type —	FSD	FSF
Shield Point Ratio —	1/2	1/2
Maximum Shield Power —	7	10
Combat Efficiency:		
D —	76.0	83.5
WDF —	11.2	14.8

851.2 1235.8

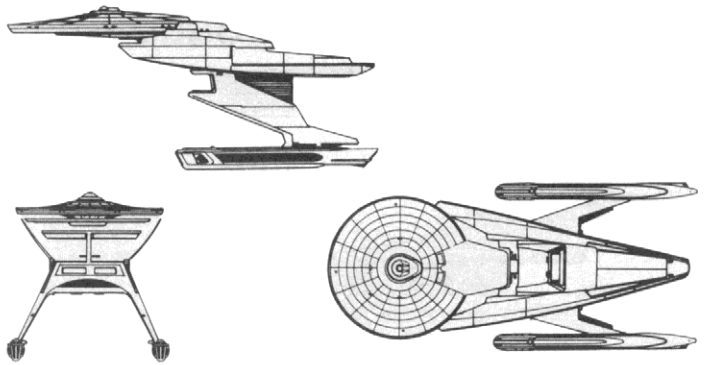

Notes:

Of the 202 Keith Class scouts built, 54 Mk IIIs remain in active service, with 101 Mk Is in reserve fleets. One Mk III is used by Star Fleet Training Command; 16 Mk Is and 4 Mk IIIs have been destroyed; 8 Mk Is and 2 Mk IIIs are listed as missing (both Mk IIIs in the Triangle area); 12 Mk Is have been scrapped; and 4 Mk Is have been sold to civilian commercial concerns.

The Keith Class scouts are produced at the Salazaar and Proxima Centauri shipyards at a combined rate of 8 per year.

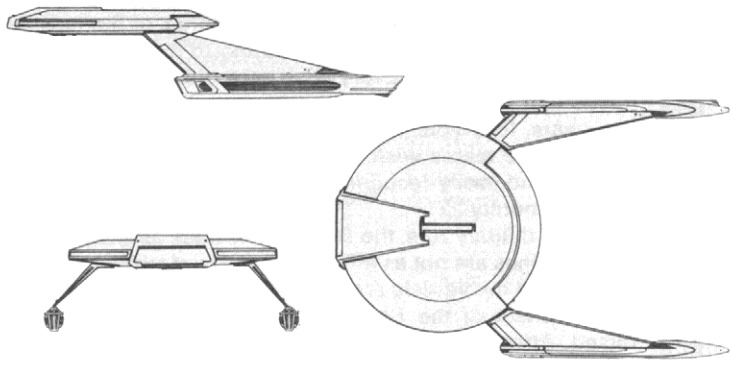

Notes:

Of the 159 Rangers built, 12 Mk Is, 31 Mk IIs, and 52 Mk IIIs remain in active service, with 2 Mk Is and 2 Mk IIs in reserve fleets. Two Mk IIs and 1 Mk III are used by Star Fleet Training Command; 26 Mk Is, 8 Mk IIs, and 1 Mk III have been destroyed; 2 Mk Is and 1 Mk II are listed as missing; 1 Mk I and 12 Mk IIs have been scrapped; and 6 Mk Is and 1 Mk II have been sold to civilian commercial concerns.

The Ranger is produced at the Sol IV and Morena facilities at a combined rate of 8 per year.

Ranger Class V-VI Scout

Construction Data:			
Model Numbers —	MK I	MK II	MK III
Date Entering Service —	2/1203	2/1710	2/2001
Number Constructed —	102	108	54
Hull Data:			
Superstructure Points —	10	12	14
Damage Chart —	C	C	C
Size:			
Length —	87 m	87 m	87 m
Width —	57 m	57 m	57 m
Height —	21 m	21 m	21 m
Weight —	55,285 mt	59,145 mt	63,325 mt
Cargo:			
Cargo Units —	20 SCU	20 SCU	20 SCU
Cargo Capacity —	1,000 mt	1,000 mt	1,000 mt
Landing Capability —	None	None	None
Equipment Data:			
Control Computer Type —	M-1	M-2	M-2
Transporters —			
standard 6 person	2	2	2
emergency 22 person	1	1	1
Other Data:			
Crew —	73	77	77
Troops —	6	6	6
Shuttlecraft —	2	2	2
Engines And Power Data:			
Total Power Units Available —	32	34	34
Movement Point Ratio —	2/1	2/1	2/1
Warp Engine Type —			
Number —	FWB-2	FWB-2	FWB-2
Power Units Available —	2	2	2
Stress Charts —	14	14	14
Maximum Safe Cruising Speed —	M/O	M/O	M/O
Emergency Speed —	Warp 8	Warp 8	Warp 8
Impulse Engine Type —	Warp 9	Warp 9	Warp 9
Power Units Available —	FIB-2	FIB-3	FIB-3
	4	6	6
Weapons And Firing Data:			
Beam Weapon Type —			
Number —	FH-2	FH-6	FH-7
Firing Arcs —	2	4 in 2 banks	4 in 2 banks
Firing Chart —	plfs	2plf, 2lfs	2plf, 2lfs
Maximum Power —	H	N	Q
Damage Modifiers —	3	3	4
+2		(1 - 7)	(1 - 8)
+1		(8 - 13)	(9 - 15)
Missile Weapon Type —			
Number —	FP-3	FP-7	FP-7
Firing Arcs —	2	2	2
Firing Chart —	1f, 1a	1f, 1a	1f, 1a
Power To Arm —	D	H	R
Damage —	1	1	1
	6	6	8
Shields Data:			
Deflector Shield Type —	FSF	FSH	FSH
Shield Point Ratio —	1/2	1/2	1/2
Maximum Shield Power —	12	14	13
Combat Efficiency:			
D —	74.3	80.2	81.0
WDF —	5.0	14.0	22.4

371.5 1122.8 1814.4

Cochrane Class VI Colonial Transport

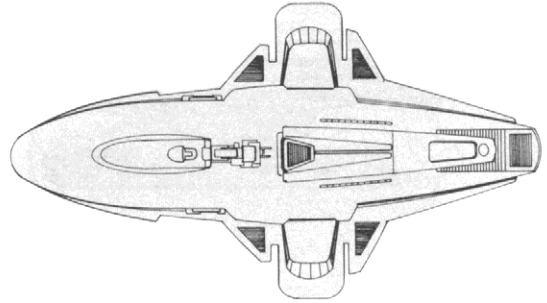
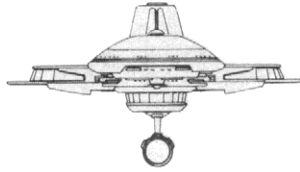
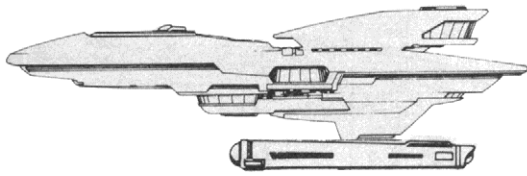

Construction Data:

Model Numbers —	MK I	MK II
Date Entering Service —	1/9010-2/0802	2/0311
Number Constructed —	206	162

Hull Data:

Superstructure Points —	13	13
Damage Chart —	C	C
Size		
Length —	370 m	370 m
Width —	210 m	210 m
Height —	110 m	110 m
Weight —	61,415 mt	61,150 mt

Cargo

Cargo Units —	4,800 SCU	4,800 SCU
Cargo Capacity —	240,000 mt	240,000 mt
Landing Capability —	None	None

Equipment Data:

Control Computer Type —	L-13	L-13
Transporters —		
standard 6-person	10	10
emergency 22-person	8	8
cargo - small	8	8
large	4	4

Other Data:

Crew —	36	38
Troops —	2,400	2,400
Shuttlecraft —	22	22

Engines And Power Data:

Total Power Units Available —	10	10
Movement Point Ratio —		
unloaded	2/1	2/1
loaded	5/1	5/1
Warp Engine Type —	FWE-1	FWE-1
Number —	1	1
Power Units Available —	8	8
Stress Charts —	F/I	F/I
Maximum Safe Cruising Speed —		
unloaded	Warp 7	Warp 7
loaded	Warp 5	Warp 5
Emergency Speed —		
unloaded	Warp 9	Warp 9
loaded	Warp 6	Warp 6
Impulse Engine Type —	FIB-1	FIB-1
Power Units Available —	2	2

Weapons And Firing Data:

Beam Weapon Type —	FL-1	FH-1
Number —	2	2
Firing Arcs —	2f/p/s	2f/p/s
Firing Chart —	D	F
Maximum Power —	2	2

Shields Data:

Deflector Shield Type —	FSG	FSF
Shield Point Ratio —	1/1	1/2
Maximum Shield Power —	12	12

Combat Efficiency:

D —		
unloaded	41.8	47.0
loaded	37.4	38.2
WDF —	8	1.0

Loaded 29.95 38.2
Unloaded 33.44 47



Notes:

The *Cochrane* Class ships are used by Star Fleet Colonial Operations Command to transport Federation colonists to new unexplored worlds. Each vessel has the capacity to carry up to 2,400 passengers and their necessities. These ships travel in large groups and are always escorted by the ships of Military Command.

When a new, undeveloped world has been charted and readied for colonization, *Cochranes* are prepared and colonists recruited. The number of ships used depends on the size of the world to be settled and the rate of development required by the UFP Council. The largest colonial convoy to date has been the Star's End settlement of Stardate 2/0310, in which 42 *Cochranes* were used. They carried over 100,000 colonists and were accompanied by freighters and transports carrying over 10,000,000 mt of supplies and building materials.

Cochranes are armed only as a protective measure. The weapons have never been used on any of these ships, largely because they are always accompanied by armed escorts.

On Stardate 2/0904, six *Cochranes* and their escorts disappeared while enroute to New Deimos. These vessels have never been found and are listed as missing. The colonial expedition consisted of 13,200 colonists and 1,250 Star Fleet officers and men. Many people have speculated that the Gorn were responsible, but no evidence has surfaced to bear this out.

Of the 308 *Cochranes* built, 120 Mk IIs remain in active service, with 58 Mk Is and 12 Mk IIs in reserve fleets ready to be recalled when the need arises. Of the remainder, 6 Mk Is and 2 Mk IIs have been destroyed; 6 Mk Is are listed as missing; 12 Mk Is and 2 Mk IIs have been scrapped; and 64 Mk Is and 26 Mk IIs have been sold to civilian commercial concerns.

The *Cochrane*, once actively produced at the Sol V facility, is no longer in production.

Aakenn Class VI Freighter

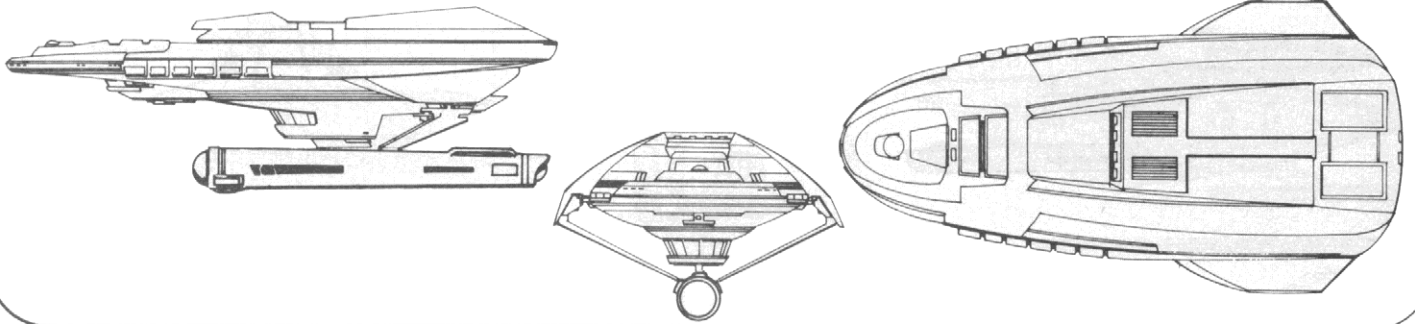

Construction Data:

Model Numbers —	MK II	MK IV
Date Entering Service —	1/9610	2/0312
Number Constructed —	672	760

Hull Data:

Superstructure Points —	10	10
Damage Chart —	C	C
Size		
Length —	190 m	190 m
Width —	100 m	100 m
Height —	60 m	60 m
Weight —	70,640 mt	71,010 mt

Cargo

Cargo Units —	2,180 SCU	2,780 SCU
Cargo Capacity —	109,000 mt	139,000 mt
Landing Capability —	None	None

Equipment Data:

Control Computer Type —	M-2	M-3
Transporters —		
standard 6-person	2	2
cargo - small	4	4
large	4	4

Other Data:

Crew —	54	58
Passengers —	6	6
Shuttlecraft —	6	6

Engines And Power Data:

Total Power Units Available —	13	19
Movement Point Ratio —		
unloaded	2/1	2/1
loaded	4/1	5/1
Warp Engine Type —	FWD-1	FWD-2
Number —	1	1
Power Units Available —	10	16
Stress Charts —	K/F	L/F
Maximum Safe Cruising Speed —		
unloaded	Warp 7	Warp 6
loaded	Warp 6	Warp 4
Emergency Speed —		
unloaded	Warp 9	Warp 8
loaded	Warp 7	Warp 6
Impulse Engine Type —	FIC-2	FIC-2
Power Units Available —	3	3

Weapons And Firing Data:

Beam Weapon Type —	FL-3	FH-2
Number —	2	2
Firing Arcs —	1f/p/s, 1a/p/s	1f/p/s, 1a/p/s
Firing Chart —	G	H
Maximum Power —	2	3
Damage Modifiers —		
+ 1	(1 - 4)	(1 - 10)

Shields Data:

Deflector Shield Type —	FSF	FSH
Shield Point Ratio —	1/2	1/2
Maximum Shield Power —	10	13

Combat Efficiency:

D —		
unloaded	46.9	60.3
loaded	37.3	44.3
WDF —	1.4	2.6



Notes:

The *Aakenn* Class freighter entered service during the Four Years War, during which the class was used to move men and materiel to the front and supplies to the rear to keep the Federation's wartime production at high levels. Presently, this freighter is a common sight on the spacelanes, with thousands in commercial service. Star Fleet uses its more than 100,000 mt of capacity to move all sorts of materials to the outer reaches of the Federation; because the vessel is not landing-capable, all cargo must be containerized and beamed aboard using the vessel's 8 cargo transporters. As an added feature, the *Aakenn* has staterooms for up to 6 passengers; these small rooms, though not designed for luxurious travel, are reasonably comfortable.

On Stardate 2/1309, the *USS Mundy*, was found adrift near Starbase 21. The vessel's onboard life support systems were operating, but there were no crewmembers aboard. The bridge area showed signs of a struggle, but nearly all computer files had been lost and there was no recorded data to reveal what had happened. The last entry in the Captain's Log, from about four months earlier, made no mention of any emergency or possible danger. When the cargo hold was breached, it was found to contain millions of live Tribbles, living on the food produced by a synthesizer that had somehow been left on.

The "Tribble Ship", as it came to be called, was taken into Starbase 21 where it was learned that it had been stolen two years earlier. This mystery remained unsolved until Stardate 2/2205, when two of its crewmembers were found in a nearby asteroid cluster, somehow having been missed when the search parties checked the area for survivors. They revealed that they had been boarded by a band of renegade Klingons, who, when they discovered that the cargo was Tribbles, became so infuriated that they killed the captain and officers and left the crewmen on the asteroid.

Of the 1432 *Aakenn* Class freighters built, 244 Mk IIs and 760 Mk IVs remain in active service and 12 Mk IIs are in reserve fleets. One Mk II and 4 Mk IVs are used by Star Fleet Training Command; 186 Mk IIs and 102 Mk IVs have been destroyed; 17 Mk IIs and 8 Mk IVs are listed as missing; 119 Mk IIs and 71 Mk IVs have been scrapped; and 93 Mk IIs and 32 Mk IVs have been sold to commercial enterprises.

The *Aakenn* Mk IV is manufactured at the Tellar, Proxima Centauri, and Cait facilities at a combined rate of 30 per year.

Liberty Class VII Freighter

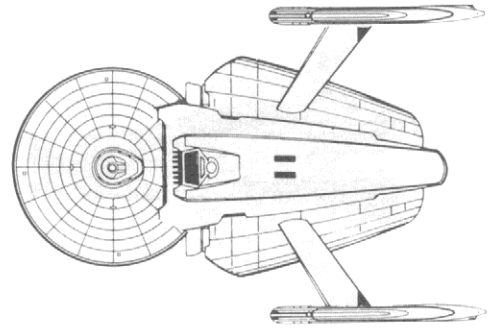
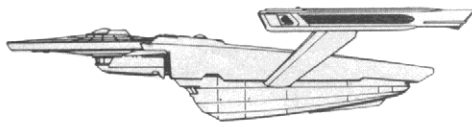

Construction Data:

	Mk I	Mk III
Model Numbers —		
Date Entering Service —	1/8806	2/0609
Number Constructed —	648	612

Hull Data:

	Mk I	Mk III
Superstructure Points —	10	11
Damage Chart —	C	C
Size		
Length —	240 m	240 m
Width —	160 m	160 m
Height —	50 m	50 m
Weight —	98,585 mt	99,690 mt

	Mk I	Mk III
Cargo		
Cargo Units —	7,030 SCU	10,000 SCU
Cargo Capacity —	351,500 mt	500,000 mt
Landing Capability —	None	None

Equipment Data:

	Mk I	Mk III
Control Computer Type —	M-1	M-2
Transporters —		
standard 6-person	2	2
cargo - small	6	6
large	4	4

Other Data:

	Mk I	Mk III
Crew —	70	72
Passengers —	20	20
Shuttlecraft —	8	8

Engines And Power Data:

	Mk I	Mk III
Total Power Units Available —	22	32
Movement Point Ratio —		
unloaded	3/1	3/1
loaded	7/1	7/1
Warp Engine Type —	FWE-1	FWE-2
Number —	2	2
Power Units Available —	8	13
Stress Charts —	G/K	G/K
Maximum Safe Cruising Speed —		
unloaded	Warp 7	Warp 7
loaded	Warp 4	Warp 4
Emergency Speed —		
unloaded	Warp 9	Warp 9
loaded	Warp 5	Warp 5
Impulse Engine Type —	FIB-3	FIC-3
Power Units Available —	6	6

Weapons And Firing Data:

	Mk I	Mk III
Beam Weapon Type —	FL-2	FH-2
Number —	2	2
Firing Arcs —	1/s, 1a/p	1/s, 1a/s
Firing Chart —	F	H
Maximum Power —	2	3
Damage Modifiers —		
+ 1		(1 - 10)

Shields Data:

	Mk I	Mk III
Deflector Shield Type —	FSG	FSH
Shield Point Ratio —	1/1	1/2
Maximum Shield Power —	10	13

Combat Efficiency:

	Mk I	Mk III
D —		
unloaded	38.6	49.2
loaded	34.5	52.3
WDF —	1.2	2.6



Notes:

The *Liberty Class* freighters have been in the service of Star Fleet since Stardate 1/8806. For 35 years, these ships have plied the spacelanes, carrying untold quantities of goods and materials to all corners of the Federation. More than any other ship, the *Liberty Class* ships symbolize the UFP's commercial advance into known space.

These freighters were used extensively during the Four Years War to carry supplies into forward areas. For such missions, they were armed to help in protecting the convoys from Klingon ambush, but their light weapons were of little use against the sophisticated weapons of the Klingons. On one occasion, a convoy made up of 20 *Liberties* was attacked by a small group of Klingon ships. They managed to drive off the Klingons, destroying one with a loss of only two vessels.

Of the 1260 *Liberty Class* freighters built, 161 Mk Is and 492 Mk IIIs remain in active service, with 68 Mk Is and 10 Mk IIIs in reserve fleets. Four Mk IIIs are used by Star Fleet Training Command; 188 Mk Is and 51 Mk IIIs have been destroyed; 24 Mk Is have been captured by the Klingons; 33 Mk Is and 9 Mk IIIs are listed as missing; 126 Mk Is and 18 Mk IIIs have been scrapped; and 48 Mk Is and 28 Mk IIIs have been sold.

Production of the Mk I was halted on Stardate 2/1203. The Mk III is produced at the Tellar, Cait, Morena, and Sol II facilities. The combined annual production rate is 32.

Kethkin Class IX Transport

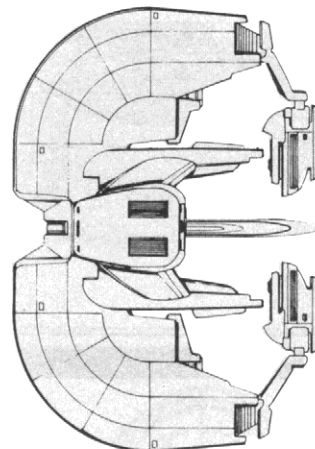
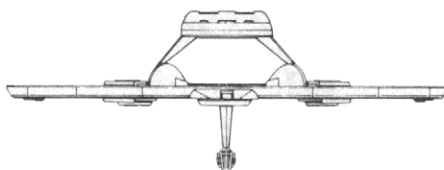
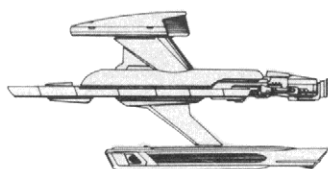

Construction Data:

Model Numbers — MK II
 Date Entering Service — 2/1801
 Number Constructed — 128

Hull Data:

Superstructure Points — 12
 Damage Chart — C
 Size
 Length — 120 m
 Width — 170 m
 Height — 60 m
 Weight — 124,300 mt

Cargo

Cargo Units — 6,500 SCU
 Cargo Capacity — 325,000 mt
 Landing Capability — None

Equipment Data:

Control Computer Type — M-6
 Transporters —
 standard 6-person 2

Other Data:

Crew — 34
 Passengers — 10
 Shuttlescraft — 6

Engines And Power Data:

Total Power Units Available — 56
 Movement Point Ratio —
 unloaded 4/1
 loaded 7/1
 Warp Engine Type — FWG-1
 Number — 2
 Power Units Available — 26
 Stress Charts — D/F
 Maximum Safe Cruising Speed —
 unloaded Warp 8
 loaded Warp 5
 Emergency Speed —
 unloaded Warp 10
 loaded Warp 7
 Impulse Engine Type — FID-2
 Power Units Available — 4

Shields Data:

Deflector Shield Type — FSF
 Shield Point Ratio — 1/2
 Maximum Shield Power — 8

Combat Efficiency:

D —
 unloaded 68.2
 loaded 52.4
 WDF — 0



Notes:

The *Kethkin* tugs, which trail their cargo pods in two rows behind them, have an overall cargo capacity of more than 325,000 mt (6,500 SCU). When loaded to this capacity, these transports are sluggish and unmaneuverable.

To aid them in maneuvering during cargo pick-up or drop-off, the *Kethkins* carry 6 specially-designed craft called 'mules'. These little vessels push the pods into position for loading or move them away during unloading operations.

Of the 128 *Kethkins* built, 124 remain in active service. One is used by Star Fleet Training Command; 1 has been destroyed; 1 is listed as missing; and 1 has been scrapped due to structural damage suffered during loading operations.

The *Kethkin* is manufactured at the Tellar, Cait, Salazaar, and Sol VI facilities. The combined rate of production is 28 per year. This vessel is commercially available.



MoKal Class X Transport

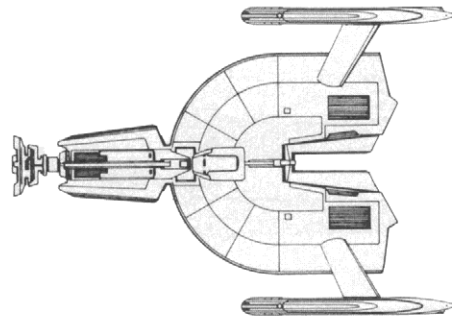
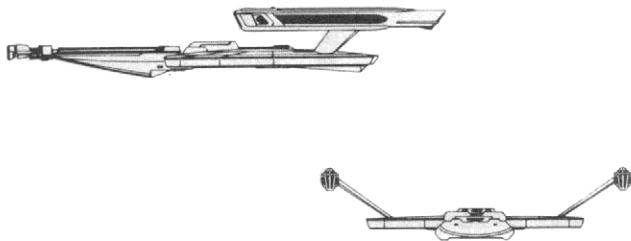

Construction Data:

	MK I	MK II
Model Numbers —	2/0804	2/1611
Date Entering Service —	2/0804	2/1611
Number Constructed —	234	126

Hull Data:

	MK I	MK II
Superstructure Points —	13	13
Damage Chart —	C	C
Size		
Length —	140 m	140 m
Width —	100 m	100 m
Height —	20 m	20 m
Weight —	145,200 mt	141,900 mt

Cargo

Cargo Units —	5,100 SCU	11,000 SCU
Cargo Capacity —	255,000 mt	550,000 mt
Landing Capability —	None	None

Equipment Data:

Control Computer Type —	M-4	M-4
Transporters —		
standard 6-person	1	1

Other Data:

Crew —	28	30
Passengers —	6	6
Shuttlecraft —	4	4

Engines And Power Data:

Total Power Units Available —	44	48
Movement Point Ratio —		
unloaded	4/1	4/1
loaded	6/1	6/1
Warp Engine Type —	FWF-1	FWG-2
Number —	2	2
Power Units Available —	20	22
Stress Charts —	G/L	H/K
Maximum Safe Cruising Speed —		
unloaded	Warp 6	Warp 8
loaded	Warp 5	Warp 6
Emergency Speed —		
unloaded	Warp 8	Warp 9
loaded	Warp 6	Warp 7
Impulse Engine Type —	FID-2	FID-2
Power Units Available —	4	4

Shields Data:

Deflector Shield Type —	FSB	FSF
Shield Point Ratio —	1/2	1/2
Maximum Shield Power —	4	8

Combat Efficiency:

D —		
unloaded	59.2	62.2
loaded	49.2	48.8
WDF —	0	0



Notes:

The *MoKal* Class, the oldest of all Star Fleet's transport vessels, is designed to push its cargo pods from behind. The *MoKal* is used by Star Fleet throughout Federation space, and is operated by civilian concerns in all of known space.

On Stardate 2/0804, the Mk I was commissioned into service; although it does not have the cargo capacity of later models, it is still in production because of its reliability and the need for moving cargoes in its particular tonnage range. The Mk I is used commercially by many corporations and transfer companies. On Stardate 2/1611, the Mk II was commissioned into service. This version of the *MoKal* is capable of transporting over 550,000 mt (11,000 SCU), an increase of 110% over the capacity of the Mk I.

Of the 360 *MoKals* built, 178 Mk Is and 113 Mk IIs are in active service, with 6 Mk Is in reserve fleets. One Mk I and 1 Mk II are used by Star Fleet Training Command; 21 Mk Is and 6 Mk IIs have been destroyed; 2 Mk Is are listed as missing; 20 Mk Is and 4 Mk IIs have been scrapped; and 6 Mk Is and 2 Mk IIs have been sold to civilian commercial concerns.

The *MoKal* is produced at the Sol V, Sol VI, and Morena facilities. The combined annual production rate is 18 of each model.

Greyhound Class I Warpshuttle/Courier

Construction Data:

<i>Model Numbers</i> —	MK I	MK IV
<i>Date Entering Service</i> —	2/1612	2/2009
<i>Number Constructed</i> —	1422	488
Hull Data:		
<i>Superstructure Points</i> —	1	1
<i>Damage Chart</i> —	C	C
<i>Size</i>		
Length —	32 m	34 m
Width —	16 m	16 m
Height —	16 m	16 m
Weight —	4,210 mt	4210 mt
<i>Cargo</i>		
Cargo Units —	4 SCU	16 SCU
Cargo Capacity —	200 mt	800 mt
Landing Capability —	Yes	Yes
Equipment Data:		
<i>Control Computer Type</i> —	L-12	L-12
<i>Transporters</i> —	standard 3 person	
<i>Other Data:</i>		
<i>Crew</i> —	2	2
<i>Passengers</i> —	12	6
Engines And Power Data:		
<i>Total Power Units Available</i> —	7	7
<i>Movement Point Ratio</i> —	1/4	1/4
<i>Warp Engine Type</i> —	FWA 1	FWA 1
Number —	1	1
Power Units Available —	6	6
Stress Charts —	F/G	F/G
Maximum Safe Cruising Speed —	Warp 8	Warp 8
Emergency Speed —	Warp 10	Warp 10
<i>Impulse Engine Type</i> —	FIA 1	FIA 1
Power Units Available —	1	1
Shields Data:		
<i>Deflector Shield Type</i> —	FSA	FSA
<i>Shield Point Ratio</i> —	1/1	1/1
Maximum Shield Power —	12	12
Combat Efficiency:		
<i>D</i> —	57.0	57.0
<i>WDF</i> —	0	0

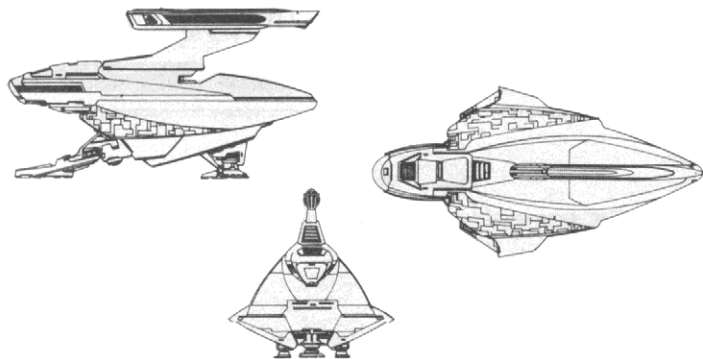

Notes:

Of the 1910 *Greyhound* Class warpshuttles built, 1342 Mk Is and 456 Mk IVs remain in active service; 40 Mk Is and 20 Mk IVs are used by Star Fleet Training Command; 28 Mk Is and 8 Mk IVs have been destroyed; 4 Mk Is and 4 Mk IVs are listed as missing; 2 Mk Is have been scrapped; and 6 Mk Is have been sold to civilian commercial concerns. The Mk IV is used commercially by Universal Parcel Service and is a very common sight around spaceports.

Greyhound Class vessels are produced at the Sol II, Sol VI, Andor, Tellar, Cait, Salazaar, and Merak shipyards. The combined production rate is 170 Mk Is and 160 Mk IVs per year.

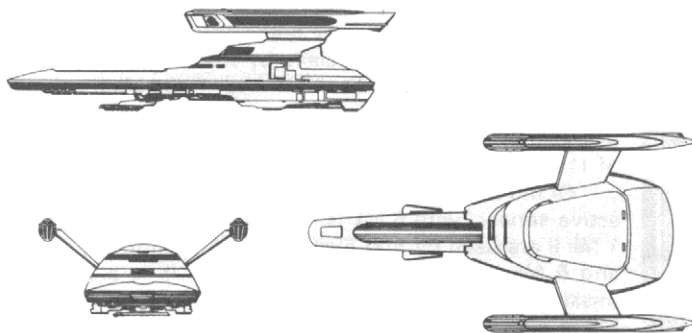

Notes:

Of the 1692 *Pulsar* Class warpshuttles built, 1459 Mk Is and 159 Mk IIs remain in active service. Of the remainder, 40 Mk Is and 6 Mk IIs are used by Star Fleet Training Command, 18 Mk Is have been destroyed, 2 Mk Is and 1 Mk II are listed as missing, 4 Mk Is have been scrapped, and 3 Mk Is have been sold to private individuals. This Warpshuttle is also commercially available and is used by several transit companies, most notably the Galactic Trailways Corporation.

The *Pulsar* is manufactured at the Sol II, Sol III, Sol V, Alpha Centauri, and Morena facilities. The combined production rate is currently 185 Mk Is and 22 Mk IIs per year.

Pulsar Class II Warpshuttle

Construction Data:

<i>Model Numbers</i> —	MK I	MK II
<i>Date Entering Service</i> —	2/1608	2/1702
<i>Number Constructed</i> —	1530	166
Hull Data:		
<i>Superstructure Points</i> —	2	3
<i>Damage Chart</i> —	C	C
<i>Size</i>		
Length —	40 m	40 m
Width —	21 m	21 m
Height —	9 m	9 m
Weight —	9,175 mt	9,675 mt
<i>Cargo</i>		
Cargo Units —	15 SCU	20 SCU
Cargo Capacity —	650 mt	1000 mt
Landing Capability —	Yes	Yes
Equipment Data:		
<i>Control Computer Type</i> —	L-14	L-14
<i>Transporters</i> —	standard 6 person	
<i>Other Data:</i>		
<i>Crew</i> —	2	3
<i>Passengers</i> —	16	10
Engines And Power Data:		
<i>Total Power Units Available</i> —	14	14
<i>Movement Point Ratio</i> —	1/1	1/1
<i>Warp Engine Type</i> —	FWA 1	FWA 1
Number —	2	2
Power Units Available —	6	6
Stress Charts —	G/K	G/K
Maximum Safe Cruising Speed —	Warp 7	Warp 7
Emergency Speed —	Warp 9	Warp 9
<i>Impulse Engine Type</i> —	FIA 2	FIA 2
Power Units Available —	2	2
Weapons And Firing Data:		
<i>Beam Weapon Type</i> —		FH-1
Number —		2
Firing Arcs —		110°s, 140°s
Firing Chart —		F
Maximum Power —		2
Shields Data:		
<i>Deflector Shield Type</i> —	FSD	FSD
<i>Shield Point Ratio</i> —	1/2	1/2
Maximum Shield Power —	12	12
Combat Efficiency:		
<i>D</i> —	59.8	59.8
<i>WDF</i> —	0	1.0

Derf Class Mk IX Tender

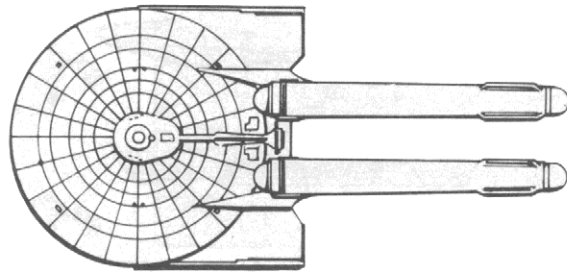
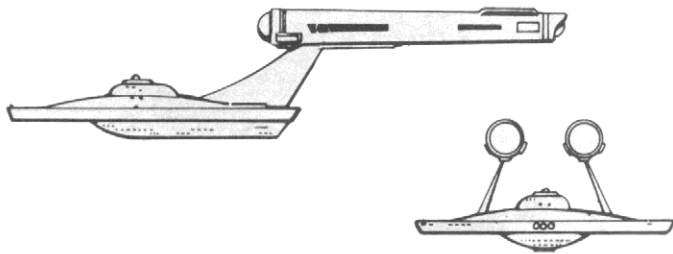

Construction Data:

Model Numbers —	MK I	MK III	MK IV
Date Entering Service —	1/9807	2/0403	2/1811
Number Constructed —	180	396	71

Hull Data:

Superstructure Points —	14	14	17
Damage Chart —	C	C	C
Size			
Length —	274 m	274 m	274 m
Width —	128 m	128 m	128 m
Height —	65 m	65 m	65 m
Weight —	126,860 mt	127,820 mt	133,120 mt

Cargo

Cargo Units —	350 SCU	350 SCU	350 SCU
Cargo Capacity —	17,500 mt	17,500 mt	17,500 mt
Landing Capability —	None	None	None

Equipment Data:

Control Computer Type —	M-2	M-3	M-3
Transporters —			
standard 6-person cargo	2	2	2
	1	1	1

Other Data:

Crew —	72	72	72
Passengers —			10
Shuttlecraft —	7	7	5

Engines And Power Data:

Total Power Units Available —	27	40	40
Movement Point Ratio —	3/1	2/1	2/1
Warp Engine Type —	FWD-1	FWD-2	FWD-2
Number —	2	2	2
Power Units Available —	12	18	18
Stress Charts —	L/G	M/G	M/G
Maximum Safe Cruising Speed —	Warp 7	Warp 6	Warp 6
Emergency Speed —	Warp 9	Warp 8	Warp 8
Impulse Engine Type —	FIC-2	FID-2	FID-2
Power Units Available —	3	4	4

Weapons And Firing Data:

Beam Weapon Type —	FH-4	FH-4	FH-4
Number —	4 in 2 banks	4 in 2 banks	6 in 2 banks
Firing Arcs —	2/fp, 2/fs	2/fp, 2/fs	2/fp, 2/fs, 2a
Firing Chart —	Q	Q	Q
Maximum Power —	3	3	3
Damage Modifiers —			
+2	(1 - 8)	(1 - 8)	(1 - 8)
+1	(9 - 14)	(9 - 14)	(9 - 14)

Shields Data:

Deflector Shield Type —	FSH	FSH	FSI
Shield Point Ratio —	1/2	1/2	1/3
Maximum Shield Power —	12	12	12

Combat Efficiency:

D —	64.0	92.0	102.0
WDF —	10.4	10.4	15.6



Notes:

The *Derf* Class tender has been operational in Star Fleet for more than 25 years. When it entered service on Stardate 1/9807, the *Derf* Class marked a new concept in navigational beacon repair. Before its introduction, marker buoys and navigational beacons had to be retrieved and returned to a repair facility to be serviced. *Derf* Class tenders eliminated this need because they carried repair facilities onboard.

When a *Derf* arrives at a malfunctioning beacon's location, a shuttle uses a tractor beam on the beacon and tows it into the lower hull, which is the tender's main repair facility. The beacon is then placed on an assembly line and repaired robotically. When the work is finished, the shuttle towed the beacon back into the spacelanes, and the *Derf* moves on.

Although the *Derf* is not designed as a fighting vessel, it is capable of aggressive defense. Most repair missions take place along the borders between the major powers, where the chances of encountering enemy ships is very high. Because of this high risk, the *Derf* is armed with medium-range phasers.

This protection does not prevent them from falling prey to enemy ships. On Stardate 2/0702, the *USS Acropolis* responded to signals from a malfunctioning marker buoy. As its shuttle neared the beacon, a Klingon warship appeared and opened fire before defensive action could be taken. The volley crippled the *Acropolis*' engines, and the tender was boarded and towed into Klingon territory.

Intelligence later discovered that the beacon had been planted by Klingon operatives to entrap the repair tender. It is theorized that the Klingons gained technical information concerning robotics and repair techniques that they lacked, but it is not known just what gain this action brought them in the overall situation. Some analysts believe that study of the robotic repair systems will make it possible for Klingons to alter the functioning of navigation beacons robotically, creating potential havoc in border spacelanes.

Of the 545 *Derfs* built, 16 Mk Is, 362 Mk IIIs, and 68 Mk IVs remain in active service, and 38 Mk Is and 17 Mk IIIs are in reserve fleets. Two Mk Is and 2 Mk IIIs are used by Star Fleet Training Command; 12 Mk Is, 8 Mk IIIs, and 1 Mk IV have been destroyed; 1 Mk III has been captured by the Klingons; 1 Mk I and 3 Mk IIIs are listed as missing; 4 Mk Is, 4 Mk IIIs, and 2 Mk IVs have been scrapped; and 2 Mk Is have been sold to the private sector.

The *Derf* Class is built at Merak. The rate of production is 4 per year.

Cle Dan Class VI Repair Tender

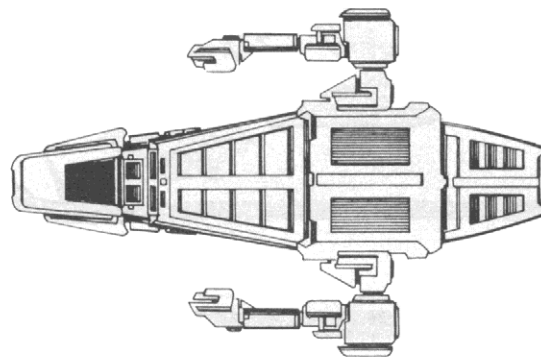
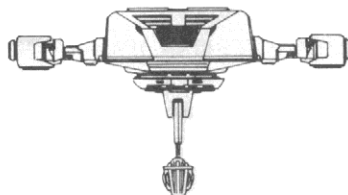
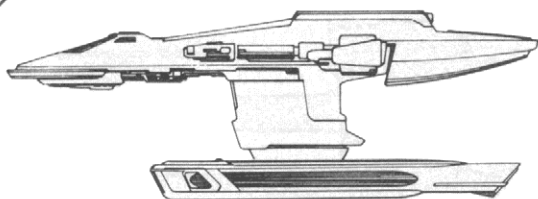

Construction Data:

Model Numbers —	MK I
Date Entering Service —	2/1110
Number Constructed —	160

Hull Data:

Superstructure Points —	7
Damage Chart —	B
Size	
Length —	100 m
Width —	65 m
Height —	35 m
Weight —	73,795 mt

Cargo

Cargo Units —	400 SCU
Cargo Capacity —	20,000 mt
Landing Capability —	None

Equipment Data:

Control Computer Type —	M-1
Transporters —	
standard 6-person	1
cargo - small	1
large	1

Other Data:

Crew —	24
Shuttlecraft —	4

Engines And Power Data:

Total Power Units Available —	23
Movement Point Ratio —	2/1
Warp Engine Type —	FWC-2
Number —	1
Power Units Available —	20
Stress Charts —	M/K
Maximum Safe Cruising Speed —	Warp 7
Emergency Speed —	Warp 9
Impulse Engine Type —	FIC-2
Power Units Available —	3

Shields Data:

Deflector Shield Type —	FSB
Shield Point Ratio —	1/2
Maximum Shield Power —	6

Combat Efficiency:

D —	52.0
WDF —	0



Notes:

The *Cle Dan* Class repair tender was designed to travel in the forward units of Star Fleet and give battlegroups a rapid repair capability. These tenders are able to repair minor damage, but, if the parts are available, they can even repair and replace warp engines. *Cle Dan* Class tenders frequently operate further forward than the *Pearl* Class mobile repair facilities, but they also are commonly found working alongside the latter. *Cle Dan* Class tenders come under the command of the OIC of Fleet Repairs, usually stationed in a *Pearl* Class facility. In extreme emergencies, however, the OIC has taken command on a *Cle Dan* itself, if the repair job is a critical one and his presence is needed at a remote location.

The repair tender uses two very large retractable arms to manipulate large parts into position. These arms can be remote-controlled from within the main hull, or they can be operated from a small station located near the end of the arm. In addition to the manipulator arms, the tenders also carry four work shuttles.

The *Cle Dan* Class is produced at the Sol III and Salazaar facilities at a rate of four per year. Of the 160 *Cle Dans* built, 136 remain in active service; 2 are used by Star Fleet Training Command; 14 have been destroyed; 1 has been captured by the Romulans; 2 are listed as missing; and 3 have been scrapped; and 2 have been sold to commercial concerns, 1 of which operates in the Triangle.

Pearl Class VII Mobile Repair Facility

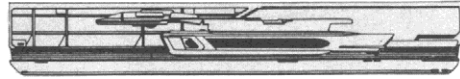
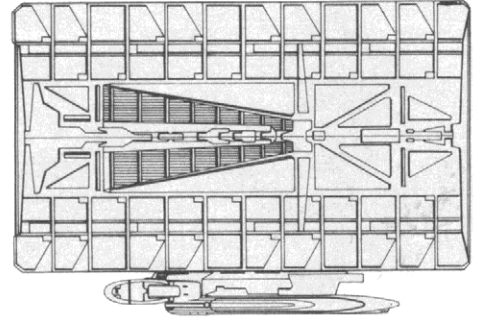
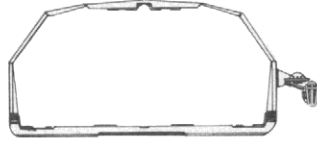
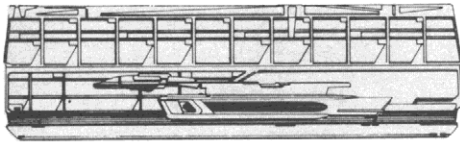

Construction Data:

Model Numbers —	MK I
Date Entering Service —	2/1212
Number Constructed —	140

Hull Data:

Superstructure Points —	12
Damage Chart —	B
Size	
Length —	360 m
Width —	200 m
Height —	85 m
Weight —	79,445 mt
Cargo	
Cargo Units —	700 SCU
Cargo Capacity —	35,000 mt
Landing Capability —	None

Equipment Data:

Control Computer Type —	L-14
Transporters —	
standard 6-person	2
emergency 22-person	2
cargo - small	2
large	2

Other Data:

Crew —	220
Passengers —	140
Shuttlecraft —	18

Engines And Power Data:

Total Power Units Available —	16
Movement Point Ratio —	3/1
Warp Engine Type —	FWD-1
Number —	1
Power Units Available —	10
Stress Charts —	K/F
Maximum Safe Cruising Speed —	Warp 6
Emergency Speed —	Warp 8
Impulse Engine Type —	FIC-3
Power Units Available —	6

Shields Data:

Deflector Shield Type —	FSB
Shield Point Ratio —	1/2
Maximum Shield Power —	5

Combat Efficiency:

D —	40.2
WDF —	0

Notes:

The first *Pearl* Class mobile repair facility was commissioned on Stardate 2/1212 to replace the *Newport News* Class facility, which was not capable of rapid deployment or housing larger ships. Unlike the older facility, the *Pearl* facility was designed to travel under its own power at Warp 6 and has enough internal bay capacity to hold no fewer than two of the *Constitution* Class cruisers. This makes it an asset in forward military operations.

Pearl repair facilities are an integral part of all Star Fleets and accompany them at all times. They are the lifeline of the fleet during combat, for they keep all ships operational. This ability was used to advantage and was decisive in the Four Years War, in which *Newport News* facilities were towed close to the front. Once in position there, they were able to keep the ships of Star Fleet in constant repair, whereas the Klingons possessed no such facility until after the war. Nevertheless, the Klingons actually launched the first truly mobile repair facility, the *S-8*, on Stardate 2/1208; it was this model that inspired the *Pearl* Class.

The repair facility has the ability to actually manufacture almost all components needed to keep the warships in repair. With limited onboard space, the repair facilities are always accompanied by several freighters carrying the spare parts needed. When in operation, a *Pearl* Class facility is surrounded by its compliment of worker bees and manned pods, giving it an appearance reminiscent of a Terran beehive.

Of the 140 mobile repair facilities built, 124 remain in active service, 2 are in reserve fleets, 4 are used by Star Fleet Training Command, 6 have been destroyed, 1 is listed as missing, 2 have been scrapped, and 1 has been sold to a commercial concern.

Pearl Class facilities generally are produced at Morena, though some actually have been built by other *Pearl* Class facilities. The production rate for this facility is three per year.

Alamo Class Defense Outpost

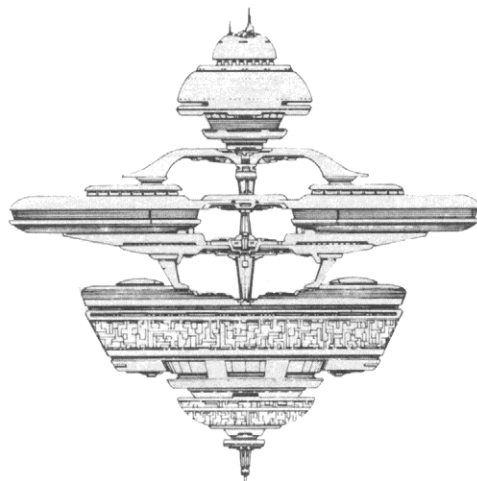
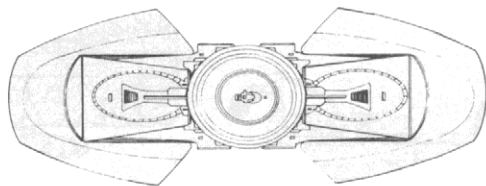
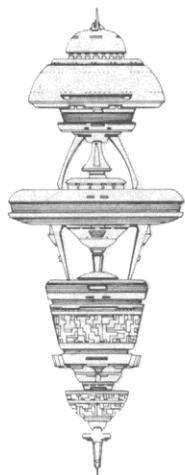

Construction Data:

Model Numbers —	MK III	MK IV
Date Entering Service —	2/0811	2/1212
Number Constructed —	161	126

Hull Data:

Superstructure Points —	64	72
Damage Chart —	C	C
Size		
Length —	560 m	560 m
Width —	195 m	195 m
Height —	510 m	510 m
Weight —	2,200,000 mt	2,500,000 mt

Cargo

Cargo Units —	2,800 SCU	3,000 SCU
Cargo Capacity —	140,000 mt	150,000 mt
Landing Capability —	None	None

Equipment Data:

Control Computer Type —	M-7	M-7
Transporters —		
standard 6-person	8	8
emergency 22-person	4	4
cargo - small	4	4
large	2	2

Other Data:

Crew —	410	460
Passengers —	280	300
Shuttlecraft —	30	30

Engines And Power Data:

Total Power Units Available —	179	204
Movement Point Ratio —	10/1	10/1
Warp Engine Type —	FMAPG-2	FMAPG-3
Number —	1	1
Power Units Available —	155	180
Impulse Engine Type —	FIPG-2	FIPG-2
Power Units Available —	24	24

Weapons And Firing Data:

Beam Weapon Type —	FH-3	FH-9
Number —	12	18
Firing Arcs —	4/arc	6/arc
Firing Chart —	W	X
Maximum Power —	5	6
Damage Modifiers —		
+3	(1 - 10)	(1 - 12)
+2	(11 - 17)	(13 - 22)
+1	(18 - 20)	
Missile Weapon Type —	FP-1	FP-4
Number —	6	6
Firing Arcs —	2/arc	2/arc
Firing Chart —	L	S
Power To Arm —	1	1
Damage —	10	20

Shields Data:

Shield Point Ratio —	1/2	1/2
Maximum Shield Power —	16	16

Combat Efficiency:

D —	151.3	210
WDF —	111	198



Notes:

The *Alamo* Class defense outpost was first placed on location on Stardate 2 0811. Since that time, 287 of these units have been positioned, usually in orbits around whatever planets are vital, serving as a defensive ring or wall. *Alamo* Class outposts, capable of withstanding a tremendous amount of punishment while delivering powerful offensive blows, are the best deterrent to Klingon aggression.

Alamo Class defense outposts are built on location. They can be moved by several specially-designed *Samson* Class tugs.

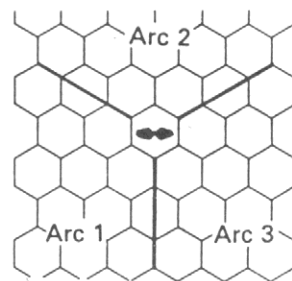

Federation Recog

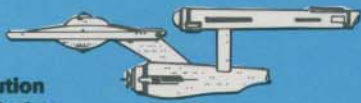

**Constitution
Class XI Cruiser**

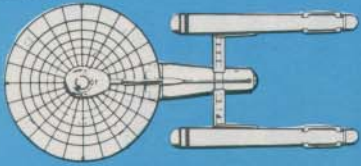

**Mo'at
Class X Transport**



**Cle Dan
Class VI Repair Tender**

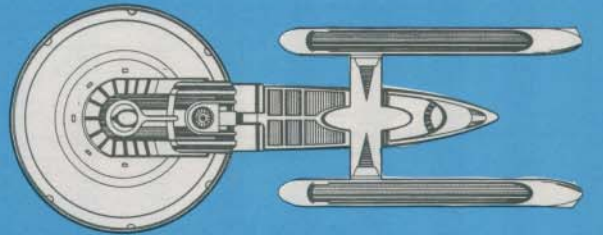

**Excelsior
Class XIII-XIV Battleship**

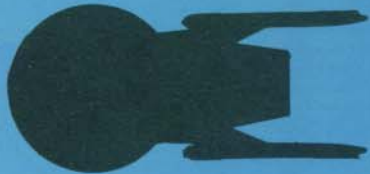

**Baker
Class IX Destroyer**



**Anton
Class X Cruiser**



**Larson
Class VII Destroyer**



**Liberty
Class VII Freighter**



**Babcock
Class XI Frigate**

**Greyhound
Class I Warpshuttle/Courier**



**Dert
Class Mk IX Buoy Tender**



**Lenthal
Class IX Destroyer**



**Pearl
Class VII Mobile Repair Facility**



**Thufir
Class VIII-IX Destroyer**



**Andor
Class IX Cruiser**

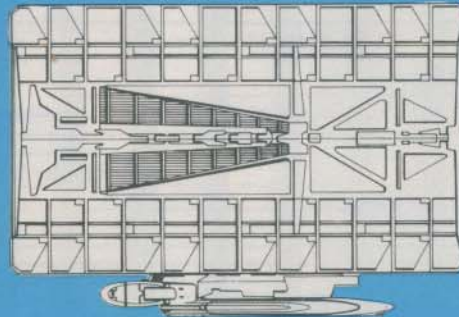

**Griffon
Class VIII Escort**



**Continent
Class IX Assault Ship**



**Northampton
Class X Frigate**



**Durrett
Class VIII Cruiser**

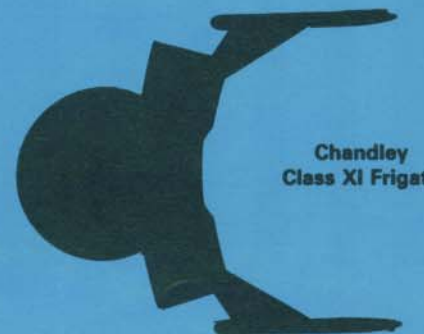

**Chandley
Class XI Frigate**

nition Silhouettes



Enterprise
Class XI Cruiser

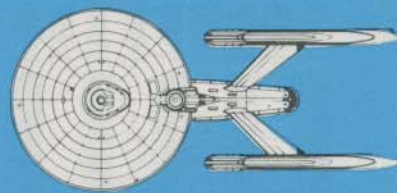

Makin
Class VII Assault Ship



Epsilon
Class III-IV Cutter

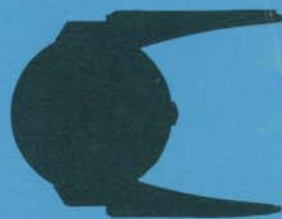

Bader
Class VIII Scout



Aakenn
Class VI Freighter



Pulsar
Class II Warpshuttle

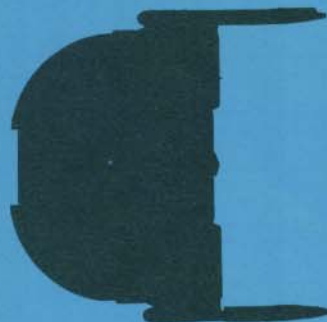

Brenton
Class XI Cruiser



Scorpio
Class II Corvette



Remora
Class VI-VII Escort

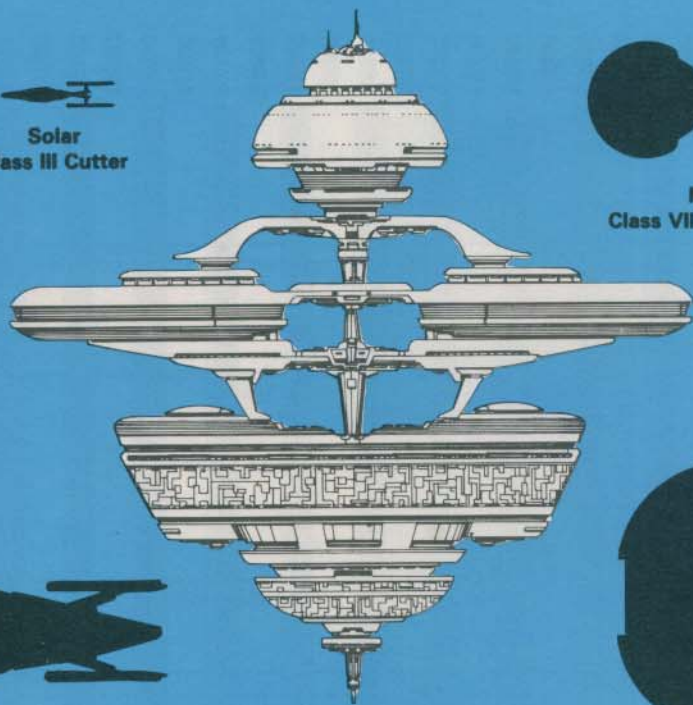

Alamo
Class Defense Outpost



Cochran
Class VI Colonial Transport



Genser
Class IV Escort



Ranger
Class V-VI Scout



Fenlon
Class V Monitor



Kiev
Class XI Frigate



Nelson
Class VII Scout



Kethkin
Class IX Transport



Wilkerson
Class IX Destroyer



Loknar
Class VIII-X Frigate

Time Line Of Act

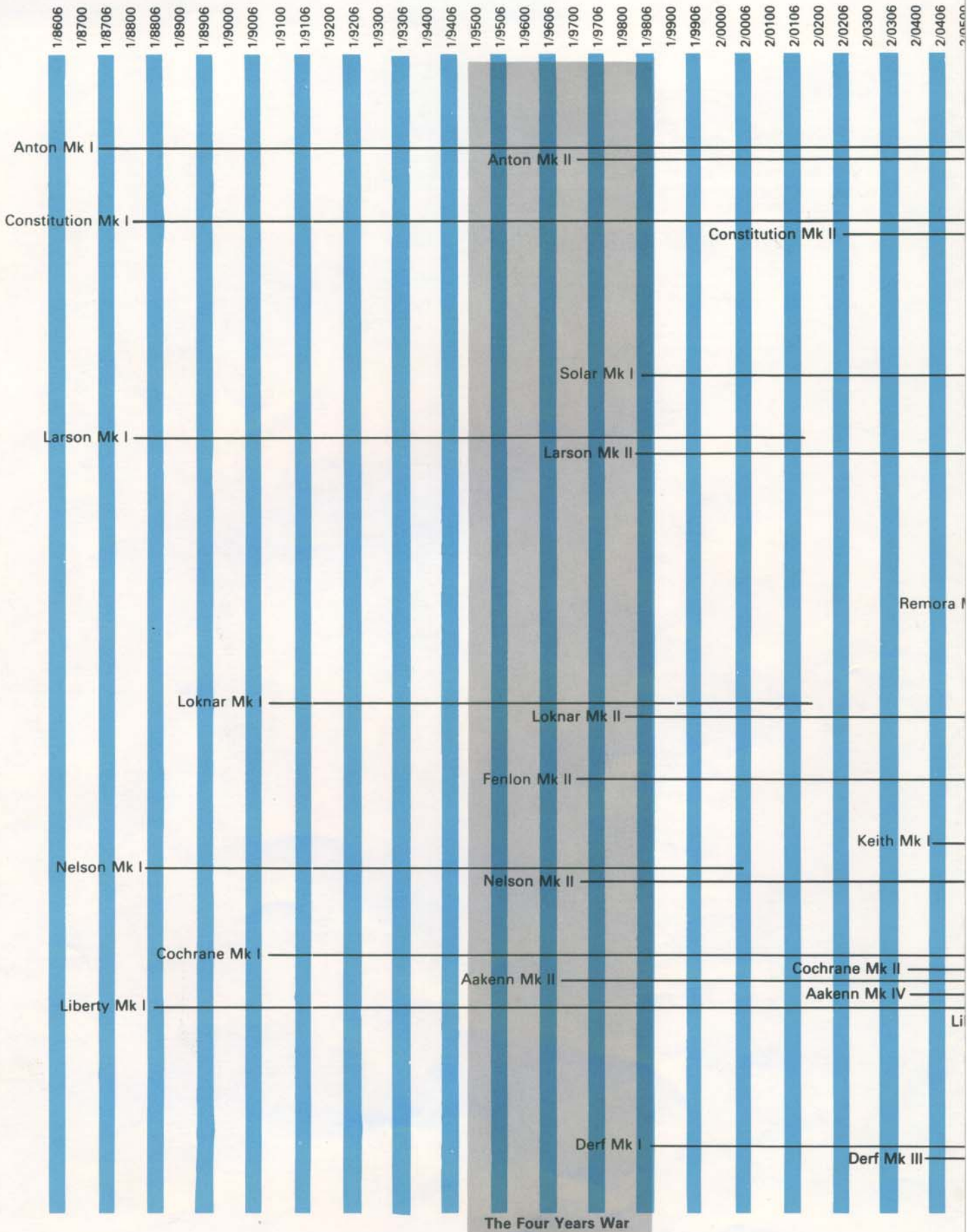

ve Service Duty

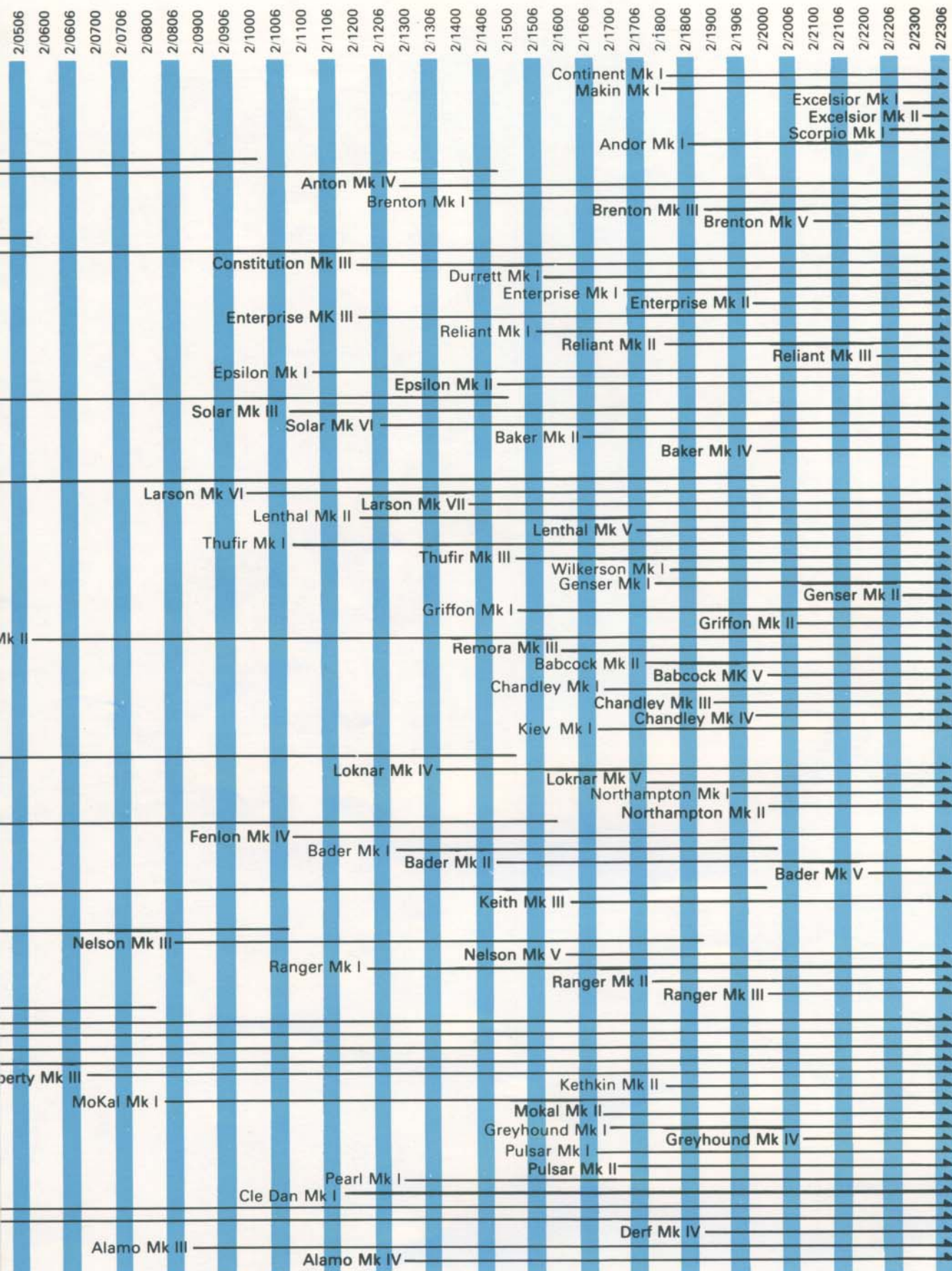

CLASSIFIED AUTHORIZED PERSONNEL ONLY

The **Federation Ship Recognition Manual** is intended for Star Fleet personnel with a "need to know" concerning information on the Star Fleet Vessels. This comprehensive study discloses all known combat, visual, and historical data on 42 different Federation ships and their variants. Also included is a chronology of service and silhouette recognition chart. This manual is a must for all *Star Trek* enthusiasts.

Shown on the front cover is a cutaway view of the Remora class VII escort. Shown on the back cover are the Scorpio class II corvettes.



STAR TREK is a trademark of Paramount Pictures Corporation and is used under exclusive license by FASA Corporation.
Copyright © 1986, 1985 Paramount Pictures Corporation
All Rights Reserved



ISBN 0-931787-42-4 FASA700