

A supplement for use with
STAR TREK[®]
THE ROLE PLAYING GAME

KLINGON

SHIP RECOGNITION MANUAL

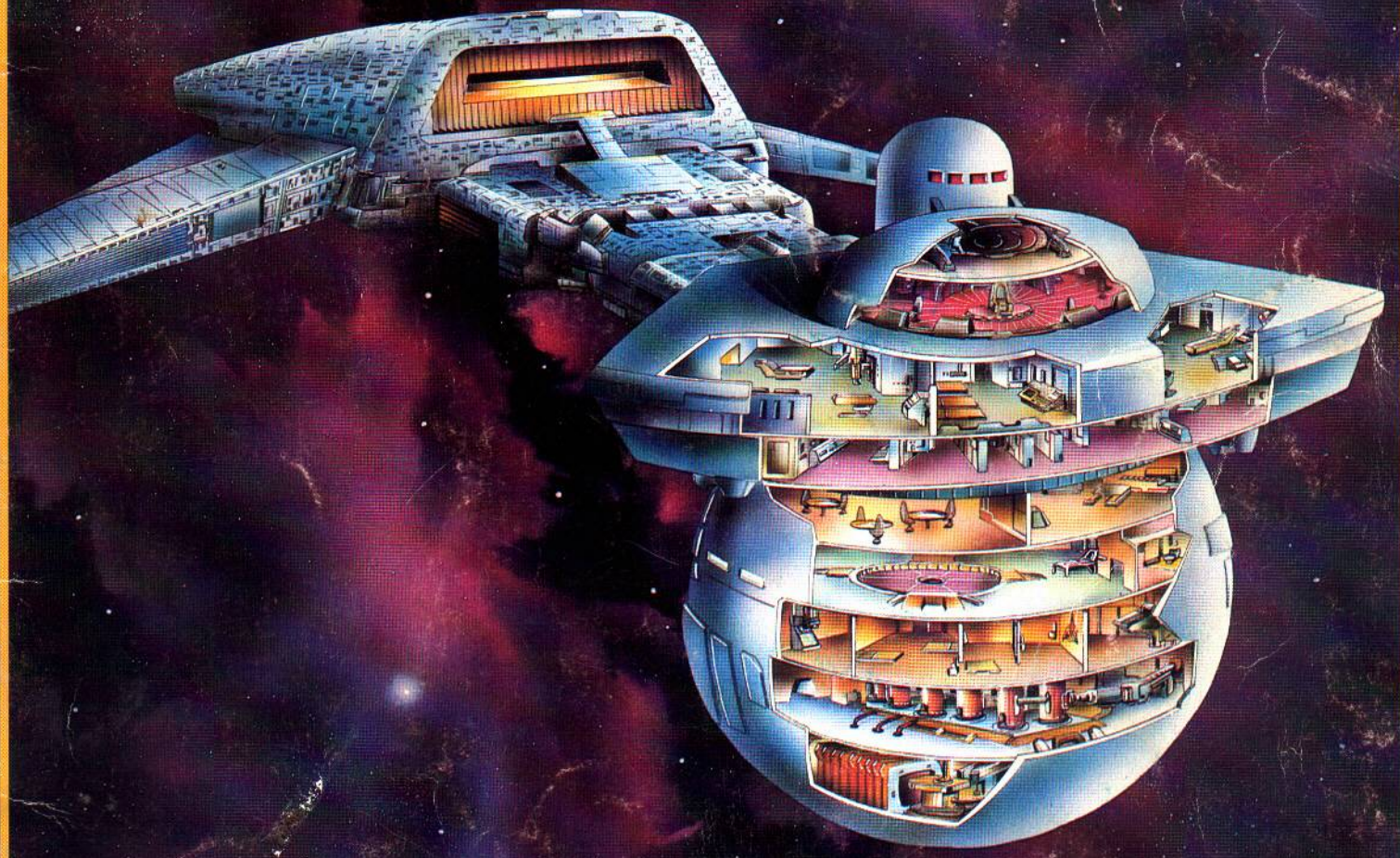

fasa

DANA KNUTSON 85



INTELLIGENCE DATA RELIABILITY RATINGS

Class A

Hard data gathered from physical examination.

Class B

Intelligence projection based on repeated scans/encounters over protracted periods. Class A plans available.

Class C

Intelligence projection based on five or fewer scans/encounters. Class B plans available.

Class D

Intelligence projection based on five or fewer scans/encounters. Class C plans available.

Class E

Spectulative projection based on hearsay/transmissions from official/semi-official sources.

Class F

Spectulative projection based on hearsay/transmissions from unofficial sources.

CHANGES TO THIS MANUAL

Users of this manual are required to submit changes in the information in this publication pursuant to SFOPS. MAN. 307/A45T. Such changes or other comments regarding this publication must be keyed to the specific page, paragraph, and line of text in which the change is recommended. Reasons should be provided for each comment to insure understanding and complete evaluation.

Comments should be prepared using SFRD Form 2028 (*Recommended Changes to Publication*) and forwarded directly to:

STAR FLEET INTELLIGENCE COMMAND

Assistant Chief of Staff,
Klingon Sector Intelligence
Williams Port, Titan 01.714

FOR AUTHORIZED USE ONLY

Unauthorized use, possession, or disclosure of the contents of this manual is strictly prohibited. All violations are treasonous acts against the United Federation of Planets. Failure to comply with directives regarding the use of this manual will result in life imprisonment, death or both.

Classified Documents Directive 998.21C

KLINGON SHIP RECOGNITION MANUAL

INTRODUCTION	3
COMBAT VESSELS	
Assault Ships	
<i>T-3 (Mover)</i>	4
<i>T-5 (Throne Seeker)</i>	4
<i>T-12 (Carrier Of Doom)</i>	5
Battleships	
<i>L-13 (Fat Man)</i>	6
<i>L-24 (Ever-Victorious)</i>	7
Cruisers	
<i>D-7 (Various names)</i>	8
<i>D-4 (Predator)</i>	10
<i>D-9 (Seeker)</i>	11
<i>D-10 (Riskadh)</i>	12
<i>D-20 (Death Rite)</i>	14
<i>D-32 (Stronger Bird)</i>	15
Destroyers	
<i>D-2 (Stingtongue)</i>	16
<i>D-11 (One Wing)</i>	17
<i>D-14 (Stinger)</i>	18
<i>D-16 (Swiftwind)</i>	19
<i>D-18 (Gull)</i>	20
Escorts	
<i>K-23 (Little Killer)</i>	22
<i>K-24 (Winner)</i>	28
<i>K-27 (Grim Reaper)</i>	29
Frigates	
<i>L-6 (Defender)</i>	30
<i>L-9 (Saber)</i>	31
<i>L-42 (Great Bird)</i>	33
Gunboats	
<i>K-3 (Kalath)</i>	34
<i>K-5 (Watcher)</i>	34
<i>K-4 (Enforcer)</i>	35
<i>K-6 (Administrator)</i>	36
Scouts	
<i>K-14 (Pathmaker)</i>	37
<i>K-17 (Deathstalker)</i>	37
<i>K-15 (Unseen Creeper)</i>	38
<i>K-22 (Bird Of Prey)</i>	39
Monitors	
<i>K-30 (Luckless)</i>	40
<i>K-32 (Strong Victor)</i>	41
SUPPORT VESSELS	
Freighters	
<i>G-3 (Baka Re')</i>	42
<i>G-8 (Traders Game)</i>	42
Transports	
<i>G-5 (Tugboat)</i>	43
<i>G-6 (Catapult)</i>	43
Warpshuttles	
<i>W-2 (Koreba)</i>	44
<i>W-4 (Speedster)</i>	44
REPAIR VESSELS AND FACILITIES	
Tenders	
<i>S-4 (Mender)</i>	45
<i>S-5 (Healer)</i>	45
Mobile Repair Facilities	
<i>S-8 (Murph)</i>	46
ORBITAL AND DEEP SPACE STATIONS	
Defense Outposts	
<i>Z-4 (Deathgame)</i>	47
TIME LINES	
Pull-out	23
RECOGNITION SILHOUETTES	
Pull-out	24

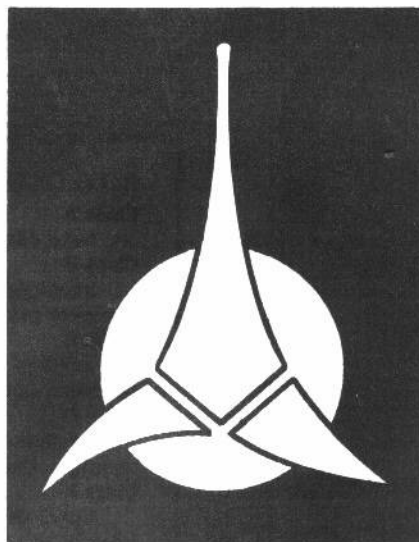

CREDITS

Design

Forest G. Brown

Writing

Forest G. Brown

Editorial Staff

Editing And Additional Writing

Wm. John Wheeler

Proofreading

Donna Ippolito

Illustration And Cover Art

Dana Knutson

Production Staff

Layout And Pasteup

Dana Knutson

Todd F. Marsh

Jane Bigos

David J. Hutchins

Typesetting

Karen Vander Mey

Introduction

THE KLINGON IMPERIAL NAVY

*From the Star Fleet Academy Commencement Address,
Stardate 2/2306.07,
by Admiral L.R. Leeper*

The lengthening shadow cast by the Klingon military machine is not the most ominous threat facing the Federation today. The last twenty years have been witness to extraordinary increases in all aspects of the Klingon armed forces. As the build-up continues unabated, all evidence points to the Klingon intent to achieve dominance in every dimension of military power. The Klingons aspire to advance, step-by step, toward galactic dominance employing every strategem short of purposeless combat.

As a consequence, the principal role of the Klingon Imperial Navy is to support political and economic moves to disrupt the alliance of Federation worlds, sap the vitality of free trade, and insulate the Romulan Star Empire and UFP from each other. Prepared for the eventuality of armed conflict at any level and at any time, the Klingon Imperial Navy has studied the lessons of past wars with great care. Thus it constitutes a many-faceted threat.

SCOPE OF THIS MANUAL

This manual describes the major ships of the Klingon Imperial Navy on a classified basis, providing an overview to authorized Star Fleet Intelligence personnel and line officers concerned with the Klingon Imperial Navy. An effort has been made to provide a comprehensive and objective presentation despite the limitations of space. It is designed for general reading and quick reference.

A historical background of Klingon starships from Stardate 1/8001 to the present is provided. Discussions of all major ships include observations on their weaknesses and strengths, and complete combat data is provided for evaluation. The overall reliability of the data available for each vessel is noted, as well as the primary information source, the records of which may be consulted if a more detailed briefing is necessary.

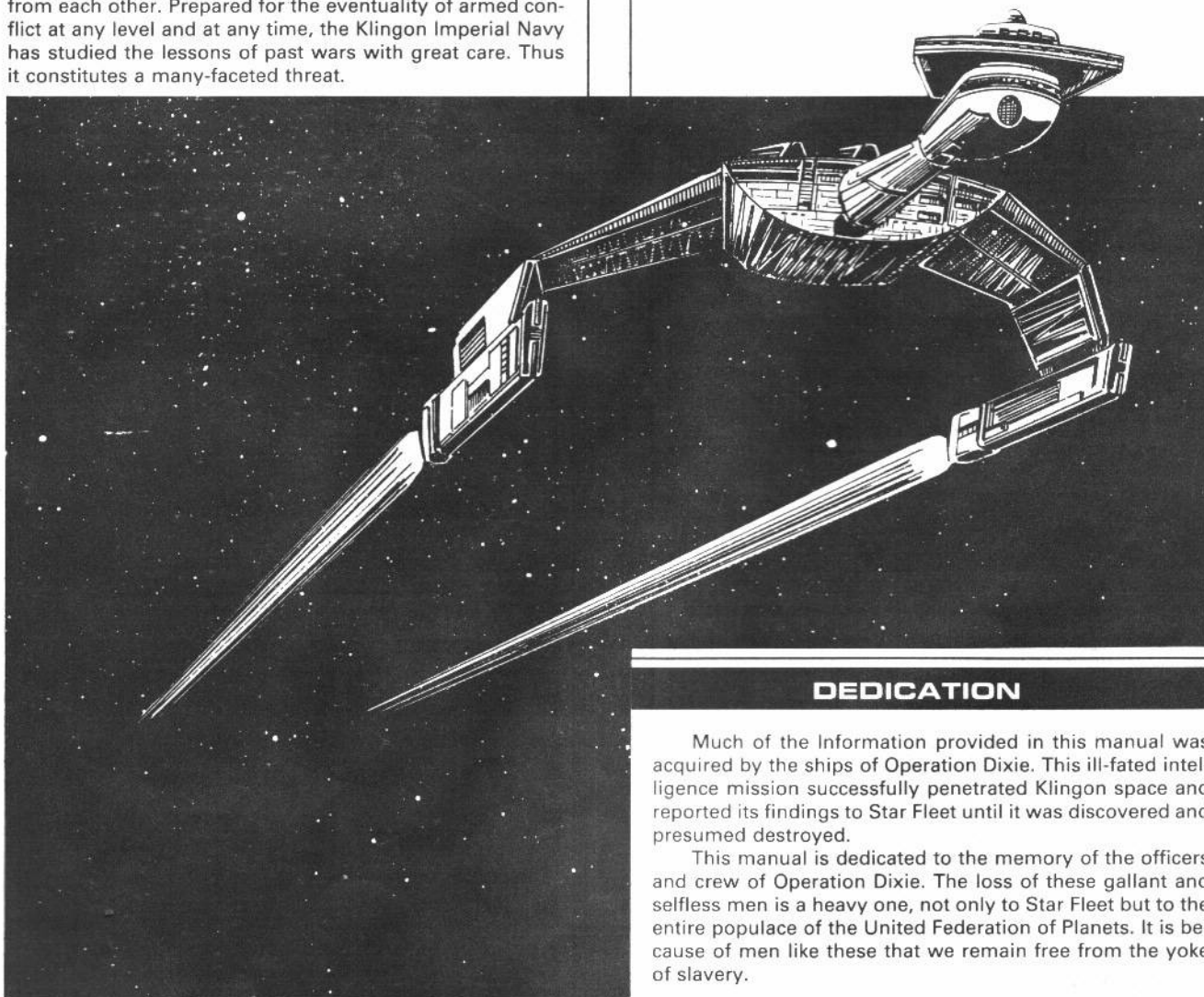

DEDICATION

Much of the Information provided in this manual was acquired by the ships of Operation Dixie. This ill-fated intelligence mission successfully penetrated Klingon space and reported its findings to Star Fleet until it was discovered and presumed destroyed.

This manual is dedicated to the memory of the officers and crew of Operation Dixie. The loss of these gallant and selfless men is a heavy one, not only to Star Fleet but to the entire populace of the United Federation of Planets. It is because of men like these that we remain free from the yoke of slavery.

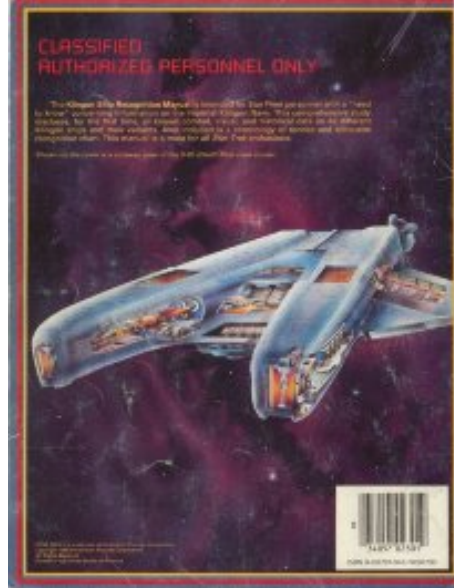

[\(click to enlarge back cover\)](#)

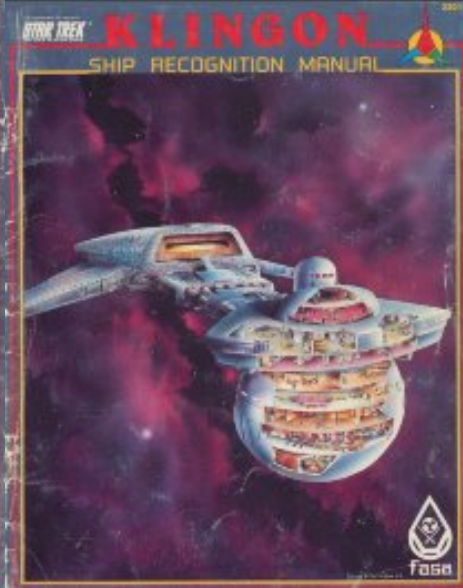

[\(click to enlarge front cover\)](#)

CREDITS

Design: Forest G. Brown

Writing: Forest G. Brown

Editing & Additional Writing: Wm. John Wheeler

Proofreading: Donna Ippolito

Illustration & Cover Art: Dana Knutson

Typesetting: Karen Vander May

Layout & Pasteup:

Dana Knutson

Todd F. Marsh

Jane Bigos

David J. Hutchins

BRAD'S COMMENTS: In my opinion the Klingon Ship Recognition Manual is far and away the most interesting of the three that FASA produced for the STSSTCS. The designs themselves are excellent, and the writing very imaginative (although apocryphal when compared to current trek canon). Many of the ships in this manual look very 'realistic' in that they adhere to the classic Klingon design philosophy established with the original D7 model ship that appeared in **ST:TOS**. Something that I don't think either the Federation or the Romulan manuals did very well, especially the Federation manual. So browse and enjoy! Ships are listed below by their ship class, as defined in the book itself. Click on the link to each ship and a window will appear giving a full graphic of the vessel, plus history and game stats. Vessel names that are *not linked* are vessels that I have not yet scanned in, but will be coming in the future.

P.S: I tried to scan each ship at as high a quality as I could, but the original format of the drawings in the manual makes this VERY difficult. The designers at FASA used an old b/w layout trick where the "gray" color that shades the ships is not gray at all, but thousands of tiny black dots on a field of white. The net effect viewed from afar by the human eye is that of 'grayness' but the scanner picks up every last dot and it takes a lot of softening/blurring and reduction via Paintshop to get the ships to look halfway decent. Even then, the images sometimes don't come out crisp. So if things seem a teeny bit fuzzy around the edges, or if the graphics don't look exactly as they did on paper, please understand that I did what I could with what I've got.

In some lucky cases I have been able to find large-scale graphics from other sources for canon ships. These graphics produce superior scans when compared to the Ship Recognition Manuals, and I have necessarily replaced the poor FASA graphics with crisp, better looking images that have been cropped, resized, and shaded manually.

Cheers!



ASSAULT SHIPS



[T-3 Mover](#)



[T-5 Throne Seeker](#)



[T-8 Frontier Transport](#)



[T-12 Carrier Of Doom](#)

[Jump to top of page](#)

BATTLESHIPS



[L-13 Fat Man](#)



[L-20 Fast Battleship](#)



[L-24 Ever-Victorious](#)



[KDF-2 K'mirra \(TNG\)](#)

[Jump to top of page](#)

CRUISERS



[D-7 \(various names\)](#)



[D-4 Predator](#)



[D-9 Seeker](#)



[D-10 Riskadh](#)



[D-20 Death Rite](#)



[D-32 Stronger Bird](#)



[Vor'cha \(TNG\) *](#)

[Jump to top of page](#)

DESTROYERS



[D-2 Stingtongue](#)



[D-11 One Wing](#)



[D-14 Stinger](#)



[D-16 Swiftwind](#)



[D-18 Gull](#)

[Jump to top of page](#)

ESCORTS



[K-23 Little Killer](#)



[K-24 Winner](#)



[K-27 Grim Reaper](#)

FRIGATES



[L-6 Defender](#)

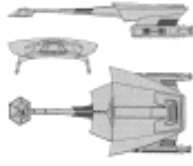

[L-9 Saber](#)



[L-42 Great Bird](#)

GUNBOATS (CUTTERS)



[K-3 Kalath](#)



[K-4 Enforcer](#)



[K-5 Watcher](#)



[K-6 Administrator](#)

SCOUTS



[K-14 Pathmaker](#)



[K-15 Unseen Creeper](#)



[K-17 Deathstalker](#)



[K-22 Bird of Prey](#)

MONITORS

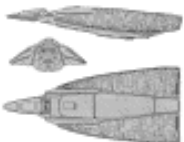

[K-30 Luckless](#)



[K-32 Strong Victor](#)

SPACE STATIONS



[Z-4 Deathgame](#)

[Jump to top of page](#)

SHUTTLES



[W-2 Koreba](#)



[W-4 Speedster](#)

[Jump to top of page](#)

MISCELLANEOUS



[G-3 Baka Re](#)
Freighter



[G-8 Traders Game](#)
Freighter



[G-5 Tugboat](#)
Transport



[G-6 Catapult](#)
Transport



[S-4 Mender](#)
Tender



[S-5 Healer](#)
Tender



[S-8 Murph](#)
Repair Facility

[Jump to top of page](#)

(TNG) Denotes a ship class that is specifically from the era of *Star Trek: The Next Generation*, and periods shortly afterward, including ST:DS9 and ST:VOY. The design may or may not be part of official Trek canon, and may or may not have been included in the FASA-produced **TNG Officers Manual**.

* Denotes a ship class NOT included with the original FASA version of the STSSTCS. The ship class itself **is** official and part of movie and television lore, but the stats are *not* necessarily official and have been written by Brad R. Torgersen as part of the continuing update.

** Denotes a ship class that is neither officially part of the FASA version of the STSSTCS, nor is it part of official Trek canon. Usually a fanship design. Gamers may choose to ignore any and all fanships, as they are completely apocryphal.



IMPORTANT NOTE:

It is entirely possible that you have surfed to this page from an internet portal and are now viewing this page without frames. **The STSSTCSMU&A is best viewed from within its own set of frames**, so [click here to jump to the main STSSTCSMU&A web page](#) and then [see the site as it was meant to be seen!](#)

T-3 'MOVER' CLASS ASSAULT SHIP

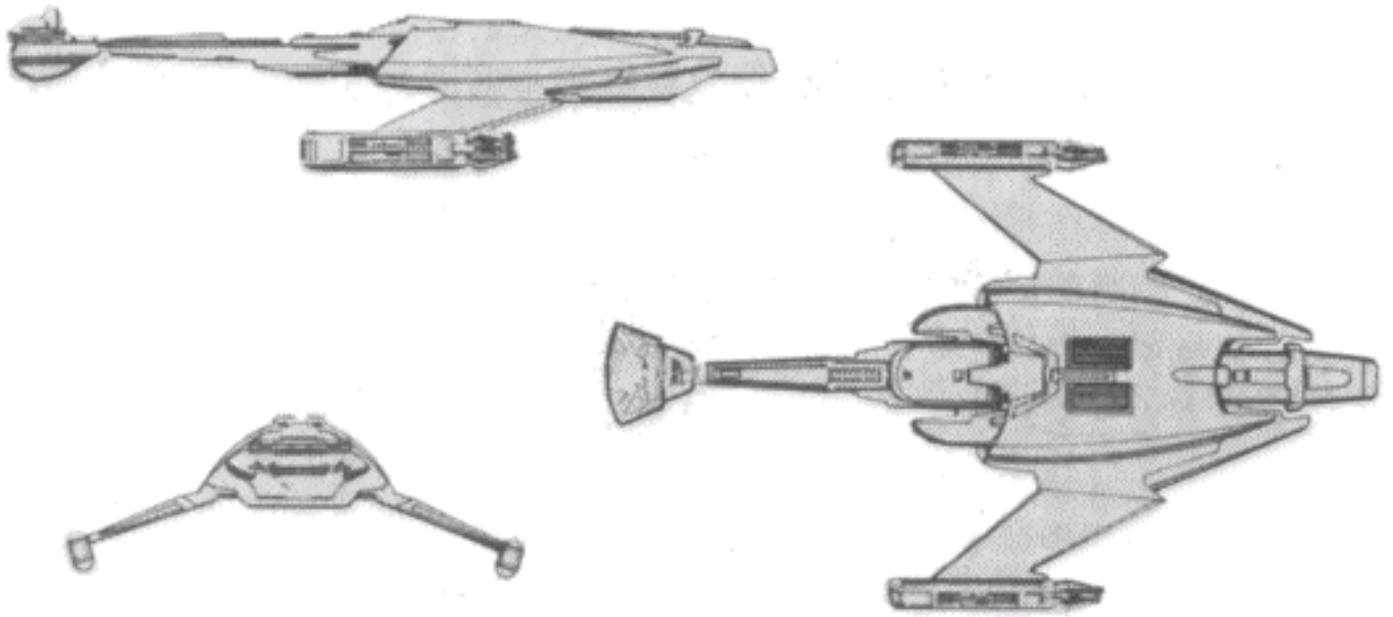

[Click here to view this ship in its own window](#)

BRAD'S COMMENTS: The first of many, many, many bogus ship designs postulated by the gang at FASA back in the mid 1980's. As has been stated before, the biggest crime committed by the Trek franchise has been to disown a great portion of the written material produced for the Trek universe. "If it 'aint on the screen, it don't mean a thing!" is the motto of the day with Star Trek, and the T-3 is yet another hapless victim of that philosophy.

Never seen in any Trek episode or movie, the T-3 is pure fiction on the part of writer Forest G. Brown and artist Dana Knutson. I give them credit for trying as hard as they could to emulate the Klingon designs available to them in 1985. At that time, the vast majority of Klingon lore and history had yet to be fleshed out. **ST:TNG** was still a pipe dream. The movies had produced exactly TWO Klingon vessels: [The Bird Of Prey](#) from **Star Trek III**, and the revamped [D7](#) that was shown in the opening sequences of **ST:TMP** and **Star Trek II**. From these two vessels Knutson and Brown had to extrapolate an entire navy of Klingon ships!

Oh yes, for those of you who think a personnel carrying assault ship is a lame idea, I suggest you think again. Too many Trek fans get myopically obsessed with cruisers/battlecruisers, believing that such warships are the only kind of ship you need to make up a fleet. Well as any mediocre military historian can tell you, it takes all kinds of craft to make a modern sea navy. So it could/should be with a space fleet.

The T-3 Mover is an attempt to design a spaceborne 'landing craft' capable of hauling soldiers up to the planetary 'beaches' and discouraging them onto the surface where battle awaits. From a tactical standpoint, this is a great idea. In any real space war, taking over planets can't be done from orbit. Men with guns have to go down and do the dirty work. And you need ships to tote those men and their guns. And tanks. And APC's. etc. etc.

Sadly, the T-3 is a wretched piece of work in terms of the STSSTCS itself. Underpowered, undergunned, and slow, it's only effective when pitted against other assault ships, or the various monitors and cutters of the Federation and Romulan Empire. Pitted against larger cruisers and frigates, the T-3 is a sitting duck. Even if massed in groups, they don't add up to much. No wonder F.G. Brown did not waste much effort on writing up a detailed history on this ship.



T-3 (Mover) Class VI Assault Ship

Known Sphere Of Operation: conflict zones

Data Reliability: B

Major Data Source: Klingon Sector Intelligence.

The T-3 is no longer in production. Of the 480 built, 286 remain in active service, 24 are in reserve fleets, 112 have been destroyed, 5 have been scrapped, and 53 have been sold to the civil sector.

The class is named from the Klingon d'aka, an obvious reference to its function.

Construction Data:

Model Numbers-	A
Ship Class-	VI
Date Entering Service-	1/9009
Number Constructed	480

Hull Data:

Superstructure Points-	10
Damage Chart-	B
Size	
Length-	250 meters
Width-	150 meters
Height-	50 meters
Weight-	73,800 tons
Cargo	
Cargo Units-	1,000 units
Cargo Capacity-	50,000 tons
Landing Capability-	None

Equipment Data:

Control Computer Type-	ZD-5
Transporters-	
Standard 6-person-	6
Combat 22-person-	6
Emergency 18-person-	2
cargo-	6
Cloaking Device Type-	None
Power Requirement-	None

Other Data:

Crew-	62
Troops-	800
Shuttlecraft-	6

Engines and Power Data:

Total Power Units Available-	30
Movement Point Ratio-	3/1
Warp Engine Type-	KWC-1
Number-	2
Power Units Available-	14
Stress Charts-	L/O
Maximum Safe Cruising Speed-	Warp 7
Emergency Speed-	Warp 8
Impulse Engine Type-	KIB-2
Power Units Available-	2

Weapons and Firing Data:

Beam Weapon Type-	KD-1
Number-	8
Firing Arcs-	6f/p/s, 2a
Firing Chart-	B
Maximum Power-	4
Damage Modifiers	
+3	
+2	NONE
+1	

Shields Data:

Deflector Shield Type-	KSC
Shield Point Ratio-	1/1
Maximum Shield Power-	9

Defense Factor- 41.3

Weapon Damage Factor- 5.6

[<<<< GO BACK](#)

IMPORTANT NOTE:

It is entirely possible that you have surfed to this page from an internet portal and are now viewing this page without frames. **The STSSTCSMU&A is best viewed from within its own set of frames**, so [click here to jump to the main STSSTCSMU&A web page](#) and then [see the site as it was meant to be seen!](#)

K-22 'BIRD OF PREY' CLASS SCOUT

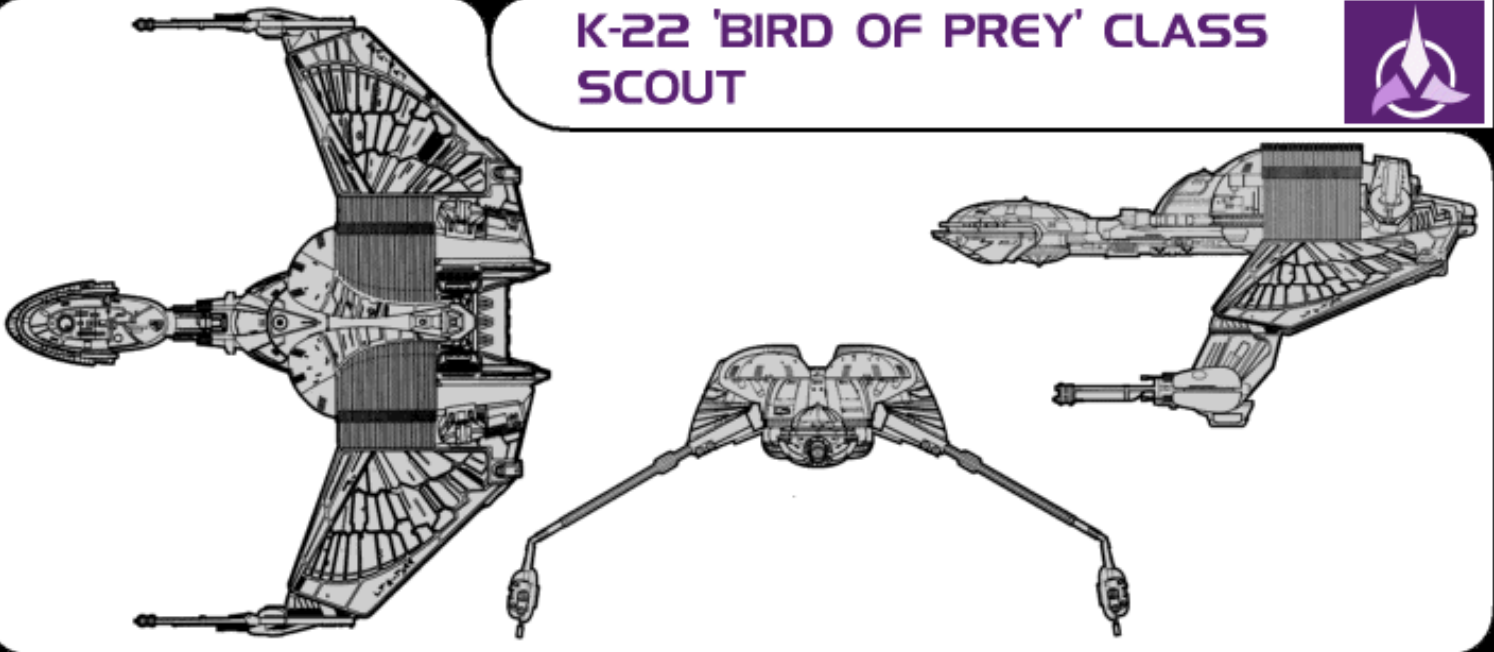

[Click here to view this ship in its own window](#)

BRAD'S COMMENTS: In the same way that the [Constitution Refit class](#) would inspire an entire new design aesthetic for Starfleet vessels, the 'Bird of Prey' class would redefine the Klingon design aesthetic, assuming an altogether sleeker and more predatory aspect when compared to the older "[D7](#)" model as seen in **ST:TOS** and **Star Trek TMP** and **Star Trek II**. I've covered most of my opinions on the 'Bird of Prey' in blurbs for the [D-32](#) and the [L-42](#) ships. Suffice to say that this smallish Scout is the craft that makes its mark on film first, and in many ways still defines what the 'Bird of Prey' is all about. This design was also the basis for much of the new FASA Romulan fleet seen in the Romulan Ship Recognition Manual--with boom-neck pod and the swept wings with 'feathering' stamped into the hull. It's hard to calculate exactly how much this single ship, as it first appeared in **Star Trek III**, has molded the Klingon ship designs of **ST:TNG** and **ST:DS9**. Certainly it is an intricate and attractive design! At the time of printing, this ship was included in *both* the Romulan and Klingon inventories, as the conventional Trek wisdom of the mid 1980's indicated that the Romulans and Klingons were still exchanging technology; and that the 'Bird of Prey' was more Romulan than Klingon in heritage. The arrival of **ST:TNG** and later **ST:DS9** obliterated this entire premise, leaving us with only the tantalizing suggestion in an early **Star Trek III** script that Kruge *stole* his Bird of Prey from the Romulans before galloping off to the Mutara Sector.



From the FASA **Star Trek KLINGON SHIP RECOGNITION MANUAL**, circa 1985

K-22 (Bird of Prey) Class V Scout

Known Sphere of Operation: Empire-wide use Data Reliability: D for K-22A; A for K-22B

Major Data Source: K-22B in Star Fleet possession, Klingon Sector Intelligence

The infamous K-22 (Bird Of Prey) scout is the Klingon prong of the double threat posed to Star Fleet by vessels of this design, equipped with cloaking devices and operated by both the Klingon and Romulan navies. The wing mechanisms of these vessels are ingenious and practical, the most interesting feature of the design. When the vessel is cruising, the wings are extended horizontally, which distributes the stress evenly throughout the vessel. When in combat, the wings are down, which gives a broader field of fire and protects a weak area on the lower central hull. When performing atmospheric operations, the wings are up, which gives more lift when the "feather" plates located along the wings, (originally thought to be merely decorative), are individually adjusted to compensate for air turbulence.

The command pod of the K-22 is a blending of Klingon and Romulan designs, but it cannot be detached in an emergency, for the heart of the ship is located in the main hull, including the computer system and the life-support system. Also located within the aft hull of the ship are the warp engines, which cannot be jettisoned, as well as the transporter system and the exit ramp. The cloaking device that is used on this vessel is unreliable at best; it has been confirmed the device is capable of driving crewmembers mad, though Federation medical specialists do not fully understand the cause.

The most important fact concerning the construction of these vessels was that the Klingons already were producing approximately 80% of the internal components prior to receiving prototypes from the Romulans. On Stardate 2/1805, the Romulans delivered seven hulls and an undetermined number of cloaking devices, and, within 13 months, the Imperial Navy commissioned its first vessels.

The S-11 hulls were fitted out into the K-22A. As received from the Romulans, they had no mounting point for an aft-firing disruptor. Intelligence reports indicate that all seven of these vessels were completed, but that afterward no production-model vessels were constructed. The disposition of these seven ships is unknown.

The first production model, the K-22B, was modified to accept the KD-12. A further modification was made to allow the KSD shielding system to be installed. These systems increase offensive capabilities by 25% and defensive capabilities by 45%. These vessels are very maneuverable in combat and have an impressive offensive capability. Although they are not really capable of fighting major warships, they are able to defend themselves long enough to engage their warp systems to escape, with the ability to travel at Warp 8 in emergencies.

The K-22B may be found in all areas of space, performing its missions of espionage and terrorism; they have been reported by Klingon, Triangle, Romulan, and Spinward Sector Intelligence as operating in those respective areas. The ability of the ship to penetrate outer defenses and travel freely about the Federation was seen recently, when one of them was captured by Admiral James T. Kirk. In an attempt to steal the plans of the secret Genesis Project, a K-22B penetrated Federation space undetected as far as the Mutara Nebula. Most of the information about this class, and the similar Romulan S-11 scout, was obtained from the computer banks of the

captured vessel.

Of the 79 K-22Bs built, 1 has been captured by Star Fleet and the remaining 78 are believed to be in active service, their whereabouts unknown. The K-22 is being produced at the Taamar facility at an approximate rate of 20 per year.

The class name is a reference to the Romulan name for the S-11; the Klingon name *D'Gavama* is a direct translation of "bird of prey".

Construction Data:

Model Numbers-	A	B
Ship Class-	V	V
Date Entering Service-	2/1805	2/1906
Number Constructed	8	72

Hull Data:

Superstructure Points-	10	10
Damage Chart-	C	C
Size		
Length-	88 meters	88 meters
Width-	130 meters	130 meters
Height-	16 meters	16 meters
Weight-	46,300 tons	47,000 tons

Cargo

Cargo Units-	5 units	5 units
Cargo Capacity-	250 tons	250 tons
Landing Capability-	Yes	Yes

Equipment Data:

Control Computer Type-	ZD-4	ZD-4
Transporters-		
Standard 6-person-	1	1
Emergency 18-person-	None	None
cargo-	None	None
Cloaking Device Type-	KCB	KCB
Power Requirement-	22	22

Other Data:

Crew-	12	14
Passengers-	None	None
Shuttlecraft-	None	None

Engines and Power Data:

Total Power Units Available-	25	25
Movement Point Ratio-	2/1	2/1
Warp Engine Type-	KWC-3	KWC-3
Number-	1	1
Power Units Available-	22	22
Stress Charts-	L/M	L/M
Maximum Safe Cruising Speed-	Warp 7	Warp 7
Emergency Speed-	Warp 8	Warp 8
Impulse Engine Type-	KIB-1	KIB-1
Power Units Available-	3	3

Weapons and Firing Data:

Beam Weapon Type-	KD-8	KD-8
Number-	2	2
Firing Arcs-	1f/p, 1f/s	1f/p, 1f/s
Firing Chart-	U	U
Maximum Power-	7	7
Damage Modifiers		
+3	(1 - 7)	(1 - 7)
+2	(8 - 15)	(8 - 15)
+1	(16 - 20)	(16 - 20)
Beam Weapon Type-		KD-12
Number-		1
Firing Arcs-		A
Firing Chart-		H
Maximum Power-		9
Damage Modifiers		
+3		(1 - 3)
+2		(4 - 8)
+1		(9 - 10)
Missile Weapon Type-	KP-5	KP-5
Number-	1	1
Firing Arcs-	F	F

Firing Chart-	Q	Q
Power To Arm-	1	1
Damage-	10	10

Shields Data:

Deflector Shield Type-	KSC	KSD
Shield Point Ratio-	1/1	1/2
Maximum Shield Power-	10	11

Defense Factor-	45.8	65.3
Weapon Damage Factor-	17.7	21.4

[<<<< GO BACK](#)

IMPORTANT NOTE:

It is entirely possible that you have surfed to this page from an internet portal and are now viewing this page without frames. **The STSSTCSMU&A is best viewed from within its own set of frames**, so [click here to jump to the main STSSTCSMU&A web page](#) and then [see the site as it was meant to be seen!](#)

D-7 (various names) CLASS CRUISER

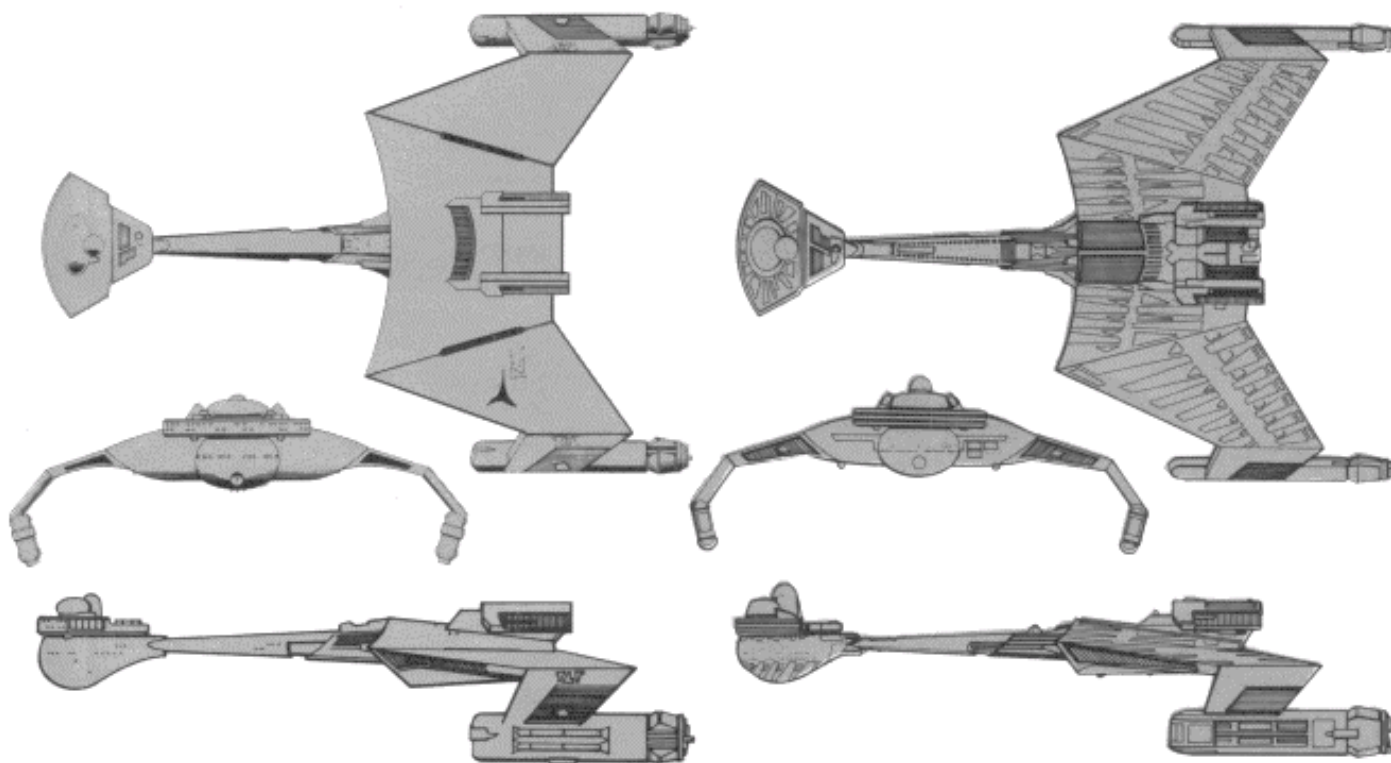

[Click here if you want to view this ship in its own window](#)



BRAD'S COMMENTS: Though this classic design does not get nearly as much screen time as the various "Bird Of Prey" Klingon ships, the old D7 model is still far and away my favorite among all Klingon vessels. First featured in the **ST:TOS** episode "The Enterprise Incident", the D7 vessel would make two more appearances in **ST:TOS**, a return engagement in the opening moments of **ST:TMP**, yet another appearance in **Star Trek II**, and a final major film outing as the flagship 'Kronos One' used by Klingon Chancellor Gorkon in **Star Trek VI**. The D7 also has sundry minor appearances in **ST:TNG** and **ST:DS9**, suggesting that



these venerable vessels underwent extensive refits and upgrades, making them viable over a century after they are first introduced in the Trek future history.

Most of the well-written background data given by the FASA manual is bogus when compared to current Trek canon, though one of the class names, "K't'inga" is right on the money. The official Star Trek Encyclopedia lists the D7 model under the name K't'inga.

The original D7 model from **ST:TOS** sets the standard for all Klingon naval designs produced afterward, just as the [Constitution hull](#) design would have a major impact on future Federation ship design philosophy. With its spread-wing main hull, long neck, head-like command pod and wingtip mounted nacelles, the D7 is rather predatory in appearance. Which is, I suppose, what the original D7 designer had in mind. I think he did some great work, and the various D-7 ships from the STSSTCS are quite fun to play, whether in fleets or in one-to-one action.

From the FASA Star Trek KLINGON SHIP RECOGNITION MANUAL, circa 1985

D-7 (Various Names) Class VII - IX Cruiser

Known Sphere Of Operation: Empire-wide use

Data Reliability: A (all models but D-7S); D for D-7S

Major Data Source: All but D-7S in Star Fleet possession; Klingon Sector Intelligence.

The D-7 is probably the most infamous cruiser ever to stalk the spacelanes. These ships are associated with death and destruction on a scale second to none. When first introduced, these vessels captured the minds and spirits of the Klingon commanders so fully that for many years they were the symbol of Klingon tyranny.

This design was developed from the earlier D-4 cruiser and incorporated all of its most popular features. The command pod mounted forward on the boom assembly and the wing-like main hull were changed slightly in the design, but all of the basic concepts were retained. In all models, the command pod can be jettisoned in case of emergency. A small micro-impulse drive system, mounted into the pod just for such emergencies, allows the pod to maneuver itself and travel short distances in hopes of rescue. A pod can maintain the life-support systems and operate the short-range sensors and weapons for up to one year. One of the main features of the pod is the disruptors mounted below the bridge; these weapons will give protection from hostiles and also allow for the self-destruction of the pod if

capture is imminent.

The secondary bridge, weapons control, and all engineering facilities are located in the main hull. Separated from the command pod, this section of the vessel is capable of maintaining fully functional life-support, weapons, and engine systems for up to two years. Of course, this section is capable of warp speeds and will effect its own rescue much quicker than can the command pod. Within the engineering section of the main hull are the matter/anti-matter mix chambers, little shielded, as servitor races man the engineering compartments of most Klingon vessels. All D-7 models are capable of jettisoning the warp engines in case of an uncontrolled mix in the matter/anti-matter chamber. This would leave the ship with only the impulse engines for power. In most cases where warp engines have had to be ejected, the command pod has been separated first to insure the captain will be safe.

In the center section of the main hull are compartments containing hypothermia capsules for the marines. The troops are kept in a frozen state until they are required, which reduces the requirement for food and life-support and thus prolongs the on-station time of the ship.

Introduced on Stardate 1/8611, the D-7A didn't see any action in the Unknown War, but the lessons learned from this conflict were reflected in its design. By Stardate 1/9302, eight separate manufacturing facilities were producing this model at a rate of five per month. When the Four Years War broke out, production of these ships soared to twelve per month within the first year and peaked at 26 per month by the third year. The Klingons, having brought the war on, were ready with over 400 of these ships in the front-line; studies have shown that this numerical advantage was the prime factor in their early advances into Federation territory. On a one-to-one basis, Federation cruisers and frigates were far superior as warships, but their limited numbers prevented them from turning the Klingons back in the early stages of the war. The D-7A class, named "Painbringer" from the Klingon K't'agga, served the Klingon Imperial Navy well in the war with a high reliability rating and ease of repairs.

Of the 1,671 D-7A's produced, 431 remain in active service, 83 have been placed in reserve fleets, 12 are used by the Klingon Naval Academy as training vessels, 891 have been destroyed, 23 have been captured (10 by Star Fleet and 13 by the Romulans), 15 are listed as missing, 26 have been scrapped, 170 have been traded to the Romulans, and 20 have been sold to ranking families within the empire.

The D-7C, introduced at the close of the Four Years War, saw no action in that conflict, but it was given its baptism of fire just seven months after entering service. The D-7C's involved in the incident were so badly outclassed by their Romulan adversaries that the design was never fully accepted by starship captains, and the model was finally removed from service on Stardate 2/2004.

The D-7C, named "Bringer Of Destiny" from the Klingon K't'kara, had more efficient warp engines than those mounted on the D-7A, but they were incapable of powering all the weapons even though the ship was more maneuverable. The designers felt that the increased warp speed and maneuvering ratio would make this ship more cost-effective, even though it was a dismal failure because of it failed to meet its design requirements as a gunship due to its inability to power all its disruptors during combat. Furthermore, though the D-7C had slightly improved shielding, this advantage was lost due to its weaker superstructure. For some unexplained reason, Klingons have never put larger warp engines on this ship, though it seems that, if this had been done early in its career, it certainly would have outclassed anything the Romulans or Star Fleet had at the time.

Of the 162 D-7Cs built, 52 have been placed in reserve fleets, 66 have been destroyed, 13 captured (9 by Star Fleet and 4 by the Romulans), 4 listed as missing, 18 sold to the Orions, 6 sold to prominent families within the Empire, and 4 sold to private groups or individuals in the Triangle.

The D-7G, named "Truthbringer" after the Klingon K't'alla, was the direct result of the first Romulan-Klingon technology exchanges, as part of which the Klingons received 24 Romulan plasma weapons of the RPL-1 type. Sixteen of these were immediately installed on D-7s, and the remaining weapons were given to weapons research firms within the Empire. The conversions to D-7G's were made on D-7A's which otherwise remained the same. The plasma weapon design required the ship to be close to the enemy in order to fire, and most Klingon commanders did not like the tactics that the weapon dictated, hence no Klingon commander felt comfortable with the conversions.

Of the 16 D-7G's built, 10 were converted to D-7R's, 4 were destroyed, 1 was captured by Star Fleet, and 1 is in the service of a ranking family within the Empire.

The D-7M, introduced on Stardate 2/1105, was a match for the Federation Constitution and Romulan V-6 (Gallant Wing) cruisers. This gave the Klingon navy a slight advantage along its borders, and the Imperial Command began to press the balance more aggressively. Both the Romulan navy and Star Fleet commissioned upgraded versions of their vessels shortly after the appearance of the D-7M in order to hold the Klingons in check. Within two years after its introduction into service, 75% of all facilities producing the D-7A had been converted to manufacture the D-7M, allowing the Klingons to place more and more of these ships in sensitive areas. As the Klingons grew bolder, these ships began to appear in the Organian Treaty Zone and in the Triangle. Traveling in groups of threes, sorties were made by Klingon commanders into areas that were declared neutral or de-militarized, and several worlds were subjugated by small forces of these ships.

The D-7M mounts the KWE-3 warp engine, which (in this configuration) gives more efficient power for maneuver and added power for the weapons systems; this warp drive system allowed the D-7 to travel at Warp 8 and, in an emergency, Warp 9. The KD-6 disruptors were replaced with the more powerful KD-8s, extending the offensive range of the ship to 200,000 km. An additional improvement, giving a punch that surprised many Romulan and Star Fleet commanders when first encountered, was the KP-3 photon torpedo mounted both fore and aft. Improved shielding was also added, increasing its capabilities by 50%.

Several vessels of this type, named "Bringer Of Destruction" from the Klingon K't'inga, have gained a level of fame equal to that of the USS Enterprise, most notably the IKV Bardur. The Bardur is known to have destroyed over 20 Romulan vessels, 10 Federation vessels, and participated in skirmishes that have accounted for the loss of over 40 enemy ships. The captain of this ship has been promoted to Admiral and, much like his Federation counterpart, remains in command of his vessel, now the smallest ship in known space to be a fleet flagship. The current position of this fleet is in the Orion sector, operating from the border starbase located there.

Of the 1,244 D-7M's built, 965 remain in active service, 198 have been destroyed, 8 have been captured (5 by Star Fleet and 3 by the Romulans), 11 have been scrapped, 36 are in the service of ranking families of the Empire, and 21 have been reported as missing. Three of those missing were destroyed during the V'ger Incident, and several others are known to be operating in the Triangle under the command of renegade Klingons.

The D-7R, named "Bringer Of Agony" after the Klingon K't'rika, was another attempt by the Klingons to make use of the plasma weapons, this time incorporated into the improved D-7M hull with the photon torpedo bays removed. The RPL-1 was placed in the bow of the ship and an additional KD-8 disrupter was placed in the aft compartment. In addition to these changes, a KCC cloaking device was added. The Klingons had learned by this time that the plasma weapon and cloak were designed to be used together, often by remaining cloaked and stationary in the path of their adversary before decloaking and firing the plasma bolt at minimum range.

Of the 32 D-7R's built, 29 remain in active service, 2 have been destroyed, and 1 has been captured by Star Fleet.

The D-7S, the newest of this line of cruisers, is an improved version of the D-7M, appearing to be a D-7M at first glance. Only well-

trained personnel will be able to tell the difference on a sensor scan, but these cruisers mount six KD-8 disruptors and fore and aft-firing KP-4 torpedoes. In addition, some models carry the KCC cloaking device.

The D-7S, named "Bringer Of Justice" from the Klingon K't'mara, is being produced at the same facilities as the D-7M, which intelligence reports show will be phased out for this much-improved version; the facilities at Taamar, Gnuu Re', losia, H'rez, and Z'hai are producing 40 M models and 22 S models per year, Of he 66 D-7Ss built, 65 remain in active service and one has been listed as missing. Although Star Fleet has encountered these vessels, none have been destroyed or captured. Orion reports from within the Triangle suggest that the Klingons are operating several small groups there.

Construction Data:

	A	C	G	M	R	S
Model Numbers-	VIII	VII	VIII	IX	IX	IX
Ship Class-	1/8611	1/9809-2/2004	2/1012-2/1511	2/1105	2/1203	2/1904
Date Entering Service-	1671	162	16	1,244	32	66
Number Constructed						

Hull Data:

Superstructure Points-	20	18	20	20	20	22
Damage Chart-	C	C	C	C	C	C
Size						
Length-	216 meters	216 meters	218 meters	221 meters	218 meters	221 meters
Width-	152 meters	152 meters	152 meters	156 meters	152 meters	156 meters
Height-	55 meters	55 meters	55 meters	62 meters	55 meters	62 meters
Weight-	100,300 tons	89,000 tons	100,400 tons	135,000 tons	134,900 tons	139,900 tons
Cargo						
Cargo Units-	120 units	120 units	100 units	120 units	80 units	160 units
Cargo Capacity-	6,000 tons	6,000 tons	5,000 tons	6,000 tons	4,000 tons	8,000 tons
Landing Capability-	None	None	None	None	None	None

Equipment Data:

Control Computer Type-	ZD-5	ZD-5	ZD-6	ZD-6	ZD-6	ZD-6
Transporters-						
Standard 6-person-	3	3	3	3	3	3
Combat 22-person-	5	4	4	5	4	5
Emergency 18-person-	1	1	1	1	1	1
cargo-	2	2	2	2	2	2
Cloaking Device Type-	None	None	None	None	KCC	KCC
Power Requirement-	None	None	None	None	32	32

Other Data:

Crew-	352	352	360	373	378	375
Troops-	220	180	110	220	110	220
Shuttlecraft-	5	5	5	5	5	5

Engines and Power Data:

Total Power Units Available-	40	32	40	44	44	44
Movement Point Ratio-	4/1	3/1	4/1	3/1	3/1	3/1
Warp Engine Type-	KWD-1	KWC-1	KWD-1	KWE-3	KWE-3	KWE-3
Number-	2	2	2	2	2	2
Power Units Available-	18	14	18	20	20	20
Stress Charts-	L/N	L/O	L/N	J/M	J/M	J/M
Maximum Safe Cruising Speed-	Warp 6	Warp 7	Warp 6	Warp 8	Warp 8	Warp 8
Emergency Speed-	Warp 8	Warp 8	Warp 8	Warp 9	Warp 9	Warp 9
Impulse Engine Type-	KIC-2	KIC-2	KIC-2	KIC-2	KIC-2	KIC-2
Power Units Available-	4	4	4	4	4	4

Weapons and Firing Data:

Beam Weapon Type-	KD-6	KD-6	KD-6	KD-8	KD-8	KD-8
Number-	4	7	4	4	6	6
Firing Arcs-	2f/p, 2f/s	2f/p, 1f, 2f/s, 2a	2f/p, 2f/s	2f/p, 2f/s	2f/p, 2f, 2f/s	2f/p, 2f, 2f/s
Firing Chart-	T	T	T	U	U	U
Maximum Power-	6	6	6	7	7	7
Damage Modifiers						
+3				(1 - 7)	(1 - 7)	(1 - 7)
+2	(1 - 18)	(1 - 18)	(1 - 18)	(8 - 15)	(8 - 15)	(8 - 15)
+1				(16 - 20)	(16 - 20)	(16 - 20)
Missile Weapon Type-			RPL-1	KP-3	RPL-1	KP-4
Number-			1	2	1	2
Firing Arcs-			F	1f, 1a	F	1f, 1a
Firing Chart-			E	R	E	Q
Power To Arm-			10	2	10	2
Damage-			See Chart	15	See Chart	18

Shields Data:

Deflector Shield Type-	KSC	KSC	KSC	KSK	KSK	KSK
Shield Point Ratio-	1/1	1/1	1/1	1/2	1/2	1/2
Maximum Shield Power-	8	9	8	12	12	12
Defense Factor-	54.6	53.2	54.6	87.6	84.6	87.5
Weapon Damage Factor-	20.4	35.7	24.3	33.4	34.4	46.4

[<<<< GO BACK](#)

IMPORTANT NOTE:

It is entirely possible that you have surfed to this page from an internet portal and are now viewing this page without frames. **The STSSTCSMU&A is best viewed from within its own set of frames**, so [click here to jump to the main STSSTCSMU&A web page](#) and then [see the site as it was meant to be seen!](#)

D-32 'STRONGER BIRD' CLASS CRUISER

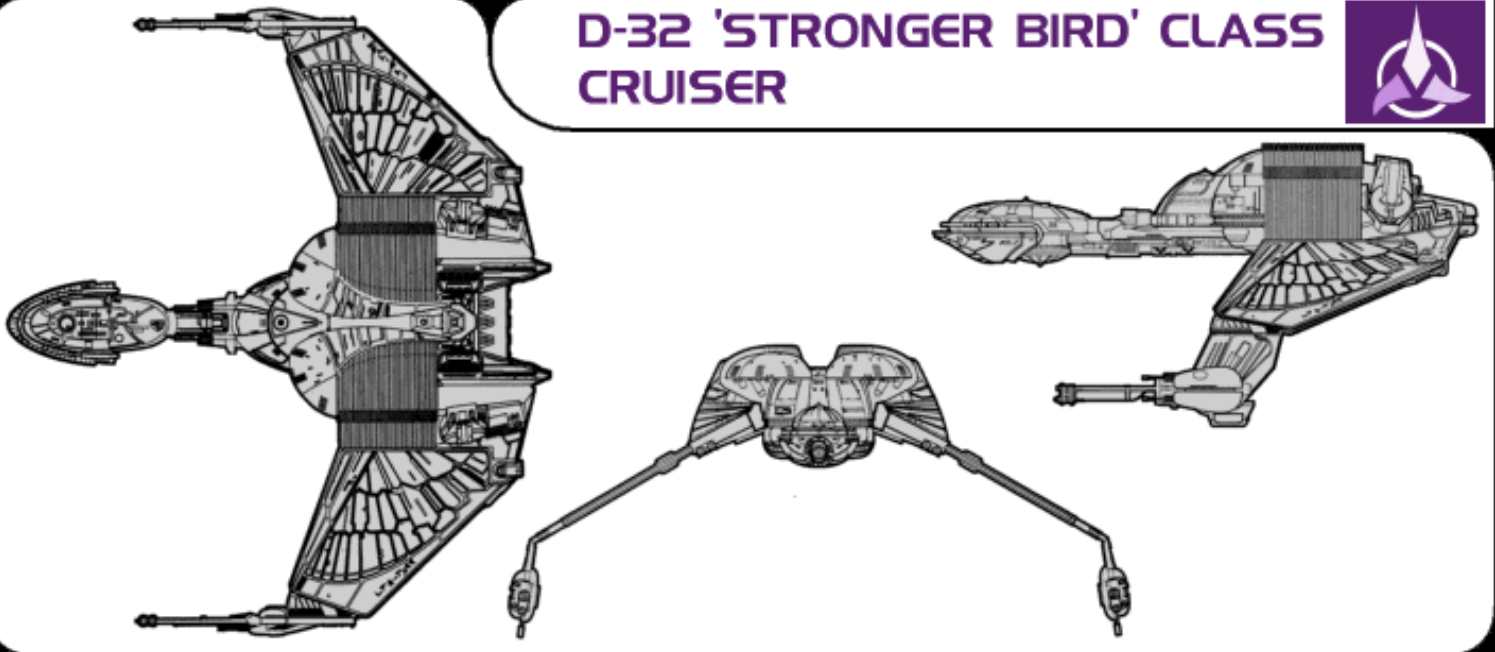

[Click here to view this ship in its own window](#)

BRAD'S COMMENTS: When the 'Bird of Prey' first appeared in **Star Trek III** under the command of the semi-renegade Commander Kruge (portrayed masterfully by Christopher Lloyd, an actor more known for his comedic talent than his dramatic flair!) nobody had any idea how much screen time this design would get. So much screen time, in fact, that the 'Bird of Prey' is now more identified with the Klingons than even the [D7 ship!](#) Whoduthunkit? Anyway, the design has been seen or even featured in 5 motion pictures and countless episodes of **ST:TNG** and **ST:DS9**, and is liable to keep on being shown.

In a strange working of fate, the history of the FASA 'Birds of Prey' is actually pretty close to that of official Trek canon. M. Okuda's *Star Trek Encyclopedia* from 1994 states that there are at least two types of this ship, a "B'rel" class scout sized craft and a "K'Vort" class cruiser sized ship. And while the three ships in the *Klingon Ship Recognition Manual* don't go under these Klingonese names, there is a scout and a cruiser, and even a frigate-type ship with the exact same design. Also, an early draft of **Star Trek III** had Kruge stealing his ship from the Romulans, which semi-jives with the FASA history wherein the "Bird of Prey" class is the result of Romulan/Klingon technology exchange. And although a Romulan connection has been officially dropped, it does somewhat confirm the writing of the original FASA manual.

In terms of game play, the D-32 cruiser is a competent ship, with a good balance of offensive and defensive equipment. Its most valuable asset is, of course, the cloaking device. The cloaking device sucks power like crazy, but enables the ship to operate with almost total impunity across the starfield map, and makes the D-32 a lethal sneak attack weapon. Combined with the other two "Bird of Prey" derivative ships, the D-32 is a lot of fun to play and makes for interesting gaming sessions.



From the FASA *Star Trek KLINGON SHIP RECOGNITION MANUAL*, circa 1985

D-32 (Stronger Bird) Class VII Cruiser

Known Sphere Of Operation: Empire-wide use

Data Reliability: C for D-32B; D for D-32C

Major Data Source: Klingon Sector Intelligence, Operation Dixie

The D-32 is one of the newest ships in the Klingon Imperial Navy, the direct result of the latest Klingon-Romulan technology exchange. On Stardate 2/1801, as part of their arrangement, the Romulans supplied the Klingons with seven S-11 Class V scoutships and the plans to construct them. The Klingons had supplied some of the technology and design for the Romulan S-11 in the first place, and they were eager to begin construction of these vessels. In fact, they had been secretly planning to produce not only scouts but to enlarge the design to a cruiser and frigate model. While the negotiations were in session, the Klingons were tooling up and producing the pieces for the larger ships, and the compartment that would house the warp and impulse drive systems along with the central wing adjustment mechanism were in production when the treaty was signed.

The most interesting aspect of the S-11 design is the movable wings, which are positioned straight out for normal cruise, down for attack, and up for atmospheric operation. In the attack mode, the ship presents a smaller target and the disruptors mounted at the wingtips have a better field of fire. In the atmospheric-flight mode, the wings take advantage of the aerodynamic design of the ship, and, in the cruise mode, the wings create a more structurally-sound design that can withstand the forces of high warp speeds. The D-32 design incorporated these features.

The first cruiser model, the D-32A, lacked the maneuverability that the Klingons desired and was modified immediately to the D-32B, the first of which was commissioned on Stardate 2/2004, only 18 months after the first S-11s were received. The ship mounts a very powerful impulse drive system that delivers 40% of the total maneuver power and gives the ship its ability to perform atmospheric operations. The weaponry is the standard mixture of disruptors and photon torpedoes; the disruptors cover all fields of fire, and the photon torpedoes are mounted both fore and aft.

The D-32C is reported to have a Romulan plasma weapon of the RPL-1 type instead of the forward-firing photon bay. It also reputedly uses the KSK shielding system, which is slightly more efficient than KSD installed on the D-32B, and the superstructure is thought to be stronger. The KCC Klingon cloaking device is used on both models, but it should prove more effective on the D-32C because of the plasma bolt weaponry.

Of the 40 D-32s built, 39 remain in active service and 1 has been destroyed. Information obtained from Operation Dixie revealed

that the class is produced at H'renn. Undocumented information suggests that Mustaka is being tool'd up for production of these vessels.

The class name is from the Klingon z'gavva, which translates to "stronger bird".

Construction Data:

Model Numbers-	B	C
Ship Class-	VII	VII
Date Entering Service-	2/2004	2/2004
Number Constructed	22	18

Hull Data:

Superstructure Points-	15	17
Damage Chart-	C	C
Size		
Length-	110 meters	110 meters
Width-	161 meters	161 meters
Height-	21 meters	21 meters
Weight-	83,700 tons	89,300 tons
Cargo		
Cargo Units-	30 units	30 units
Cargo Capacity-	1,500 tons	1,500 tons
Landing Capability-	Yes	Yes

Equipment Data:

Control Computer Type-	ZD-5	ZD-6
Transporters-		
Standard 6-person-	2	2
Combat 22-person-	None	None
Emergency 18-person-	2	2
cargo-	1	1
Cloaking Device Type-	KCC	KCC
Power Requirement-	32	32

Other Data:

Crew-	142	148
Troops-	None	None
Passengers-	5	5
Shuttlecraft-	1	1

Engines and Power Data:

Total Power Units Available-	46	46
Movement Point Ratio-	4/1	4/1
Warp Engine Type-	KWC-1	KWC-1
Number-	2	2
Power Units Available-	14	14
Stress Charts-	L/O	L/O
Maximum Safe Cruising Speed-	Warp 7	Warp 7
Emergency Speed-	Warp 8	Warp 8
Impulse Engine Type-	KIE-3	KIE-3
Power Units Available-	18	18

Weapons and Firing Data:

Beam Weapon Type-	KD-9	KD-9
Number-	4	4
Firing Arcs-	2f/p, 2f/s	2f/p, 2f/s
Firing Chart-	W	W
Maximum Power-	5	5
Damage Modifiers		
+3	(1 - 7)	(1 - 7)
+2	(8 - 15)	(8 - 15)
+1	(16 - 20)	(16 - 20)
Missile Weapon Type-		RPL-1
Number-		1
Firing Arcs-		F
Firing Chart-		E
Power to Arm-		10
Damage-		See Chart
Missile Weapon Type-	KP-5	KP-5
Number-	2	1
Firing Arcs-	1f, 1a	A
Firing Chart-	Q	Q
Power to Arm-	1	1
Damage-	10	10

Shields Data:

Deflector Shield Type-	KSD	KSK
Shield Point Ratio-	1/2	1/2
Maximum Shield Power-	10	13
Defense Factor-	68.5	75.3
Weapon Damage Factor-	31.0	29.4

[<<<< GO BACK](#)

IMPORTANT NOTE:

It is entirely possible that you have surfed to this page from an internet portal and are now viewing this page without frames. **The STSSTCSMU&A is best viewed from within its own set of frames**, so [click here to jump to the main STSSTCSMU&A web page](#) and then [see the site as it was meant to be seen!](#)

L-42 'GREAT BIRD' CLASS FRIGATE

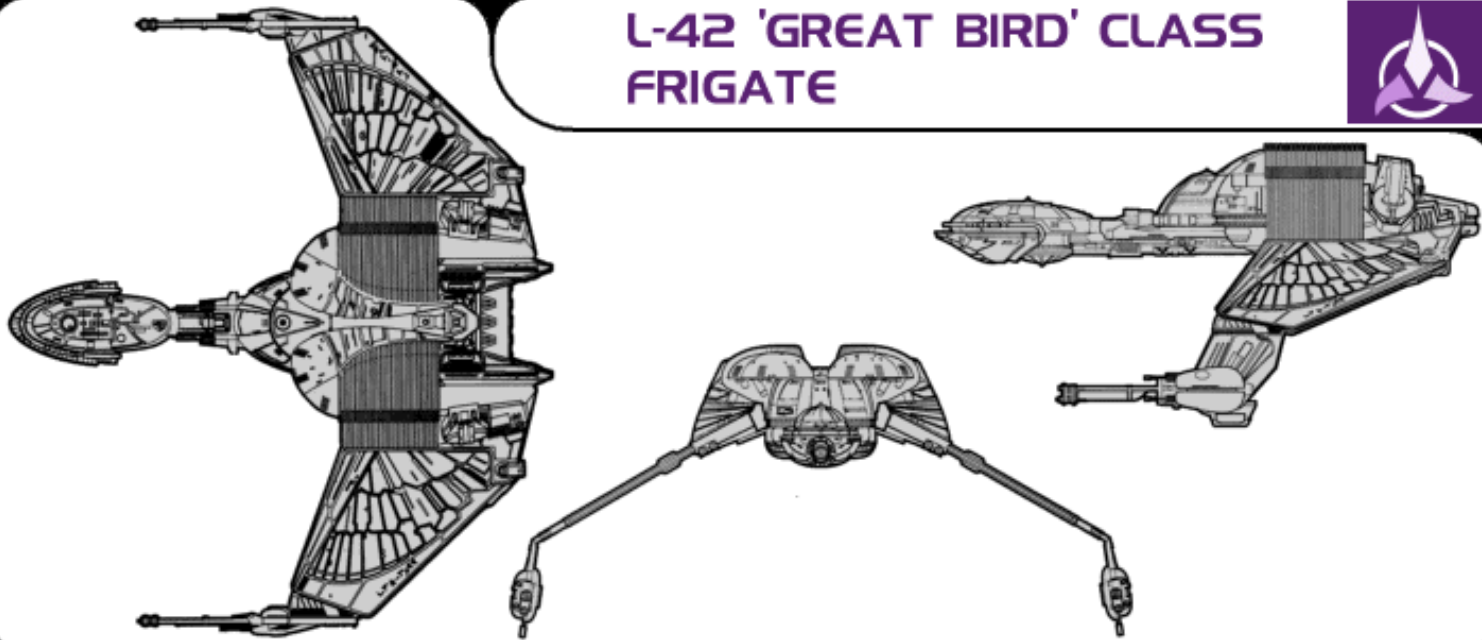

[Click here to view this ship in its own window](#)

BRAD'S COMMENTS: The largest of the three 'Bird of Prey' class ships, the L-42 looks no different from the smaller [K-22 scout](#) (the ship FASA says was seen throughout **Star Trek III** and **Star Trek IV**) and the mid-sized [D-32 cruiser](#). In a strange way, having three different ship classes that all look alike is accurate with current canon, because it seems obvious in **ST:TNG** and **ST:DS9** that the Klingon Empire operates a variety of different types of 'Bird of Prey' style ships, though on the TV shows they are not always called a 'Bird of Prey'.

The L-42 being classified as a frigate is yet another example of what I consider to be a mistake on the part of the FASA writers, in that a frigate in 21st century Earth terms is smaller than your average sea cruiser and not as heavily armed. Like so many FASA frigates the L-42 is a match for some of the bigger cruisers, doing well against ships like the [V-27](#), [Enterprise \(Constitution Refit\)](#), and [Reliant \(Miranda/Soyuz\)](#) classes, to say nothing of other overpowered frigates like the Chandley class. In game play this ship can be lethal due to its cloaking capacity, which most other large Klingon vessels do not have. My best tactics usually involve cloaking the L-42 and pouring the rest of the available power into movement and torpedoes. Spend movement phases getting in close to the enemy, then de-cloak and fire. Don't worry about shields, with the cloaking device on you will never have enough juice left to energize them significantly anyway. The L-42's torpedoes give it a great punch, and a lucky shot can usually disable or destroy most smaller craft, and seriously damage similarly-sized vessels.

Sooner or later I will probably try and provide TNG-era stats for this ship, since it is featured throughout the adventures of Enterprise-D and Deep Space 9. Until then, it's still a good design and a lot of fun to play.

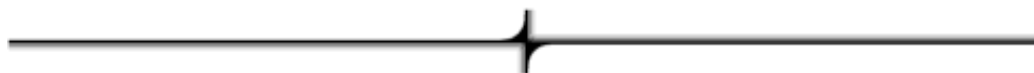

From the FASA Star Trek KLINGON SHIP RECOGNITION MANUAL, circa 1985

L-42 (Great Bird) Class IX - X Cruiser

Known Sphere Of Operation: Triangle and Romulan borders

Data Reliability: D for D-42A; E for D-42B

Major Data Source: Operation Dixie; Triangle Sector Intelligence

The L-42 frigate is the largest vessel type produced as a direct result of the last Klingon-Romulan technology exchange. Taking its hull design from the Romulan S-11 class scout, these frigates look very much like a giant K-22 class scout or D-32 class cruiser, sporting the same type of adjustable wings. When cruising, the wings are horizontal and when in combat, they are down; they have no up position for landing, as the vessel is much too large for atmospheric operations. The command pod can be jettisoned in case of emergency, with the entire boom section detaching from the main hull. A departure from standard design is the mounting of disruptors into banks of three, providing devastatingly- concentrated firepower but increasing the danger of major reductions from weapons hits. The efficient engines of the L-42A provide high maneuverability and give extra power to weapons and shields; these vessels are more maneuverable than most capital ships in both the Romulan Navy and Star Fleet.

The L-42B is reported to be more powerful overall but not as maneuverable. It is said to mount two forward and two aft-firing KP-6 torpedoes. The strength of the superstructure is also said to have been increased.

Of the approximately 20 L-42s believed to have been built, Operation Dixie reported one has been destroyed. The disposition of the remainder is not known. Operation Dixie further reports that the L-42s are currently being produced at the Mustaka shipyards at an approximate rate of six per year. It is highly unlikely that the Klingons will keep the rate at this level, but an increase in the number of facilities is likely and may be underway already. The reports from Operation Dixie indicate that the class is equipped with a cloaking device, but the reliability of such devices on vessels this size is questionable.

The class name is a direct translation of the Klingon *z'gavasta*.

Construction Data:

Model Numbers-	A	B
Ship Class-	IX	X
Date Entering Service-	2/2101	2/2106
Number Constructed	12	8

Hull Data:

Superstructure Points-	22	26
Damage Chart-	C	C
Size		
Length-	164 meters	164 meters
Width-	242 meters	242 meters
Height-	31 meters	31 meters
Weight-	120,000 tons	146,400 tons
Cargo		
Cargo Units-	60 units	60 units
Cargo Capacity-	3,000 tons	3,000 tons
Landing Capability-	None	None

Equipment Data:

Control Computer Type-	ZD-6	ZD-6
Transporters-		
Standard 6-person-	3	3
Combat 22-person-	None	None
Emergency 18-person-	2	2
cargo-	1	1
Cloaking Device Type-	KCC	KCD
Power Requirement-	32	48

Other Data:

Crew-	220	240
Troops-	None	None
Passengers-	10	10
Shuttlecraft-	2	2

Engines and Power Data:

Total Power Units Available-	55	63
Movement Point Ratio-	3/1	4/1
Warp Engine Type-	KWF-1	KWE-3
Number-	2	2
Power Units Available-	16	20
Stress Charts-	H/J	H/J
Maximum Safe Cruising Speed-	Warp 8	Warp 7
Emergency Speed-	Warp 9	Warp 8
Impulse Engine Type-	KIF-2	KIF-2
Power Units Available-	23	23

Weapons and Firing Data:

Beam Weapon Type-	KD-13	KD-13
Number-	6	6
Firing Arcs-	3f/p, 3f/s	3f/p, 3f/s
Firing Chart-	X	X
Maximum Power-	5	5
Damage Modifiers		
+3	(1 - 7)	(1 - 7)
+2	(8 - 15)	(8 - 15)
+1	(16 - 22)	(16 - 22)
Missile Weapon Type-	KP-6	KP-5
Number-	1	4
Firing Arcs-	F	2f, 2a
Firing Chart-	R	Q
Power to Arm-	2	1
Damage-	20	10

Shields Data:

Deflector Shield Type-	KSP	KSP
Shield Point Ratio-	1/3	1/3
Maximum Shield Power-	15	15

Defense Factor-	130.5	133.2
Weapon Damage Factor-	40.1	57.8

IMPORTANT NOTE:

It is entirely possible that you have surfed to this page from an internet portal and are now viewing this page without frames. **The STSSTCSMU&A is best viewed from within its own set of frames**, so [click here to jump to the main STSSTCSMU&A web page](#) and then [see the site as it was meant to be seen!](#)

T-5 'THRONE SEEKER' CLASS ASSAULT SHIP

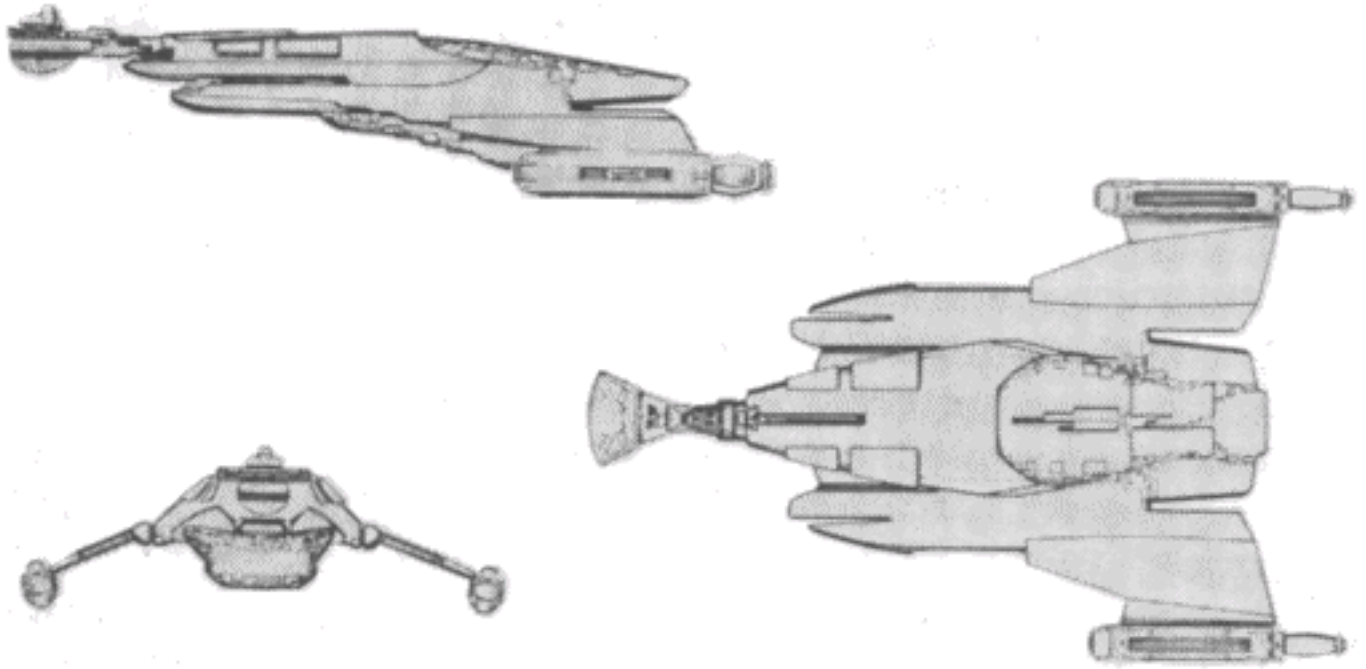

[Click here to view this ship in its own window](#)

BRAD'S COMMENTS: Not much different from the [T-3](#), the T-5 is another fictional and fabricated Klingon vessel with a tad more power and a pad more protection than the T-3. As with most assault ships, the T-5 is great as "window dressing" for campaigns involving planetary invasion as part of their goal. Keep these ships out of harms way for as long as you can. With a superstructure this weak, it only takes one or two well-placed torpedo shots from a cruiser to destroy the T-5 outright. The one saving grace of this class, in my opinion, is the fact that the game designers did a decent amount of extrapolation from the classic "Klingon" look; wings, neck-and-pod, slung warp nacelles, and a predator-like appearance. Too bad this vessel type never made it beyond the pages of the ill-fated FASA manuals.



From the FASA Star Trek KLINGON SHIP RECOGNITION MANUAL, circa 1985

T-5 (Throne Seeker) Class VII Assault Ship

Known Sphere Of Operation: Conflict Zones

Data Reliability: B

Major Data Source: Klingon Sector Intelligence

The T-5 is capable of beaming down 292 troops, 8 light support vehicles and 2 tanks every 2 minutes. In less than 10 minutes, 1,400 troops, 32 light support vehicles, and 8 tanks can be placed on the ground ready to attack. Of the 343 built, 21 T-5A's and 253 T-5B's remain in active service. Four T-5's are in reserve fleets, and 47 have been destroyed. Fourteen T-5A's and four T-5B's have been sold to the civil sector. 120 A models have been converted to B models. T-5's, named from the Klingon "mas to gal", are being manufactured at Fonawl and Mustaka, where 14 per year of the combined types are produced.

Construction Data:

Model Numbers-	A	B
Ship Class-	VII	VII
Date Entering Service-	2/0310-2/2105	2/1211
Number Constructed	210	133

Hull Data:

Superstructure Points-	10	12
Damage Chart-	C	C
Size		
Length-	270 meters	270 meters
Width-	165 meters	165 meters
Height-	60 meters	60 meters
Weight-	83,700 tons	88,200 tons
Cargo		
Cargo Units-	1,200 units	1,200 units
Cargo Capacity-	60,000 tons	60,000 tons
Landing Capability-	None	None

Equipment Data:

Control Computer Type-	ZD-5	ZD-5
Transporters-		
Standard 6-person-	6	6
Combat 22-person-	10	10
Emergency 18-person-	2	2
cargo, small-	8	8
cargo, large-	2	2
Cloaking Device Type-	None	None
Power Requirement-	None	None

Other Data:

Crew-	74	76
Troops-	1,400	1,400
Shuttlecraft-	15	15

Engines and Power Data:

Total Power Units Available-	38	40
Movement Point Ratio-	4/1	4/1
Warp Engine Type-	KWD-1	KWD-1
Number-	2	2
Power Units Available-	18	18
Stress Charts-	L/N	L/N
Maximum Safe Cruising Speed-	Warp 6	Warp 6
Emergency Speed-	Warp 8	Warp 8
Impulse Engine Type-	KIB-2	KID-2
Power Units Available-	2	4

Weapons and Firing Data:

Beam Weapon Type-	KD-1	KD-11
Number-	6	6
Firing Arcs-	2f, 1p, 1s, 2a	2f, 1p, 1s, 2a
Firing Chart-	B	F
Maximum Power-	4	5
Damage Modifiers		
+3		
+2	NONE	(1 - 4)
+1		(5 - 8)

Shields Data:

Deflector Shield Type-	KSJ	KSG
Shield Point Ratio-	2/3	1/2
Maximum Shield Power-	13	10

Defense Factor-	53.3	61.2
Weapon Damage Factor-	4.2	10.2

[<<<< GO BACK](#)

IMPORTANT NOTE:

It is entirely possible that you have surfed to this page from an internet portal and are now viewing this page without frames. **The STSSTCSMU&A is best viewed from within its own set of frames**, so [click here to jump to the main STSSTCSMU&A web page](#) and then [see the site as it was meant to be seen!](#)

T-8 CLASS TROOP TRANSPORT

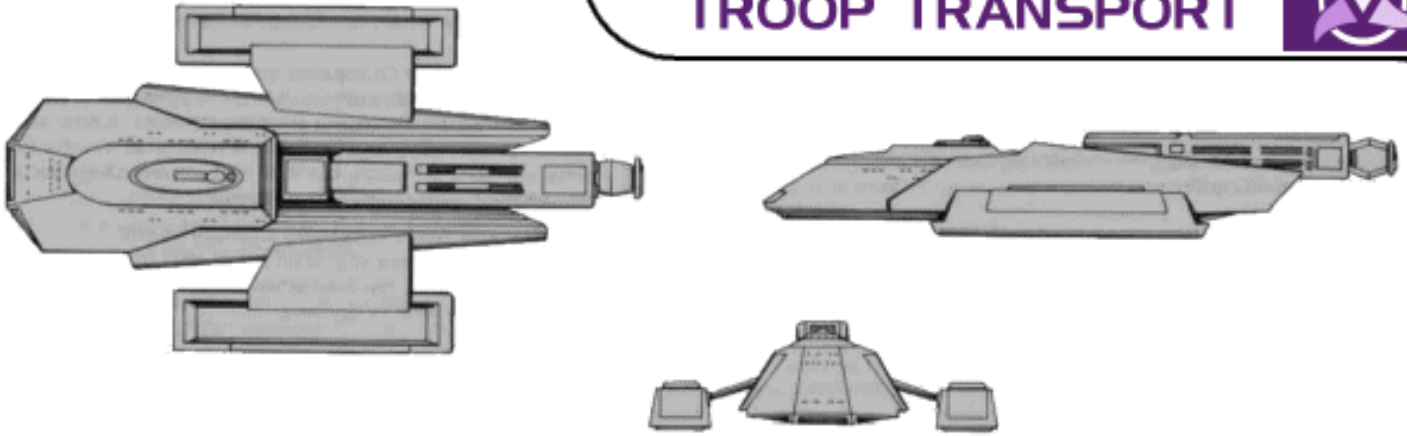

[Click here to view this ship in its own window](#)

BRAD'S COMMENTS: Holy cow, the Klingons have gotten their hands on the Battlestar Galactica!!! Heh heh heh... No, not really. But I must admit, the design and apparent function of those shuttle bays is remarkably Battlestarish. This is another design furnished by [Bernard Guignard](#) and I wish that I could have made the drawings above a little bit bigger. However, for quality reasons, I had to go with a smaller version, so some of the detail is not quite as apparent as it ought to be. This ship is also the first new Klingon design added to the Klingon section in probably 8 months! Thanks Bernard!



From the FASA Star Trek Starship Tactical Combat Simulator, circa 1983 - 1986

T-8 Class VI Frontier Area Troop Carrier

Notes: The T-8 class troop transport is one of the main types of military personnel transport in the Klingon Empire. To better handle the greater risk and danger of frontier areas, a modified version of the T-8 class was built.

A bow-mounted KD-8 disruptor bank is added to these models, in addition to the KD-4 disruptors mounted port and starboard on the upper dorsal spine of the vessel in front of the warp engine. This gives the T-8 class vessels an almost 360 degree arc of fire and almost twice the firepower its present class had; a valuable asset on the imperial border.

The T-8 class also is the first to have the new and still experimental 50-man assault transporter. Equipped with 5 of these huge pieces of machinery, T-8 transports can beam down their entire contingent of 800 troops in less than 6 minutes. Of course, the power drain is enormous, and the ships must be well-protected during the beaming operation, as no other power systems except life support can operate while the huge transporters are energized.

Confidential reports indicate that the new transporters are susceptible to power fluctuations during the beam-down process, due mainly to occasional timing errors in the energy relay circuits. This has caused 20% disincorporation (ie: loss of pattern) on mass beam-downs when these power fluctuations occur. Because of this, it isn't known whether or not this transporter system will see further operational use in other classes. Some discussion has taken place regarding the replacement of the new 50-man transporters by the more standard and well-proven 22-man type.

For extended missions, the T-8 class has 600 hypothermia sleep capsules installed for the troops being transported. Because the official attrition rate for these capsules is 4%, it is customary to carry 25 to 50 extra troops in them to make sure the unit is at full strength at warm-up. The 200 officers and special service personnel of the unit remain awake.

Another interesting feature of the T-8 vessels is the large number of troop shuttlecraft carried for use when transporter operations are not feasible. The T-8 class carries 4 J-1 class and 20 J-3 class shuttlecraft housed in 2 large shuttle bays on the port and starboard sides of the vessel. For continuous operations, the bays are designed to allow simultaneous exit from the forward end of the hangar and entrance from the aft end, thereby avoiding any traffic coordination problems.

Construction Data:

Model Numbers-	A
Ship Class-	VI
Date Entering Service-	2/1800
Number Constructed	56

Hull Data:

Superstructure Points-	16
Damage Chart-	C
Size	
Length-	145 meters
Width-	132 meters
Height-	42 meters
Weight-	75,000 tons
Cargo	
Cargo Units-	2,000 units
Cargo Capacity-	100,000 tons
Landing Capability-	None

Equipment Data:

Control Computer Type-	unknown
Transporters-	
Standard 6-person-	2
Combat 50-person-	5
Emergency 18-person-	none
cargo small	none
large	2
Cloaking Device Type-	none
Power Requirement-	none

Other Data:

Crew-	175
Troops-	800
Shuttlecraft-	24

Engines and Power Data:

Total Power Units Available-	22
Movement Point Ratio-	3/1
Warp Engine Type-	KWC
Number-	1
Power Units Available-	18
Stress Charts-	L/M
Maximum Safe Cruising Speed-	Warp 6
Emergency Speed-	Warp 7
Impulse Engine Type-	KIC
Power Units Available-	4

Weapons and Firing Data:

Beam Weapon Type-	KD-4
Number-	2
Firing Arcs-	1f/p/s, 1a/p/s
Firing Chart-	O
Maximum Power-	4
Damage Modifiers	
+3	
+2	(1 - 10)
+1	KD-8
Beam Weapon Type-	KD-8
Number-	1
Firing Arcs-	1f/p/s
Firing Chart-	U
Maximum Power-	7
Damage Modifiers	
+3	(1 - 7)
+2	(8 - 16)
+1	(17 - 20)

Shields Data:

Deflector Shield Type-	KSB
Shield Point Ratio-	1/1
Maximum Shield Power-	7

Defense Factor-
Weapon Damage Factor-

unknown
unknown

[<<<< GO BACK](#)

IMPORTANT NOTE:

It is entirely possible that you have surfed to this page from an internet portal and are now viewing this page without frames. **The STSSTCSMU&A is best viewed from within its own set of frames**, so [click here to jump to the main STSSTCSMU&A web page](#) and then [see the site as it was meant to be seen!](#)

T-12 'CARRIER OF DOOM' CLASS ASSAULT SHIP

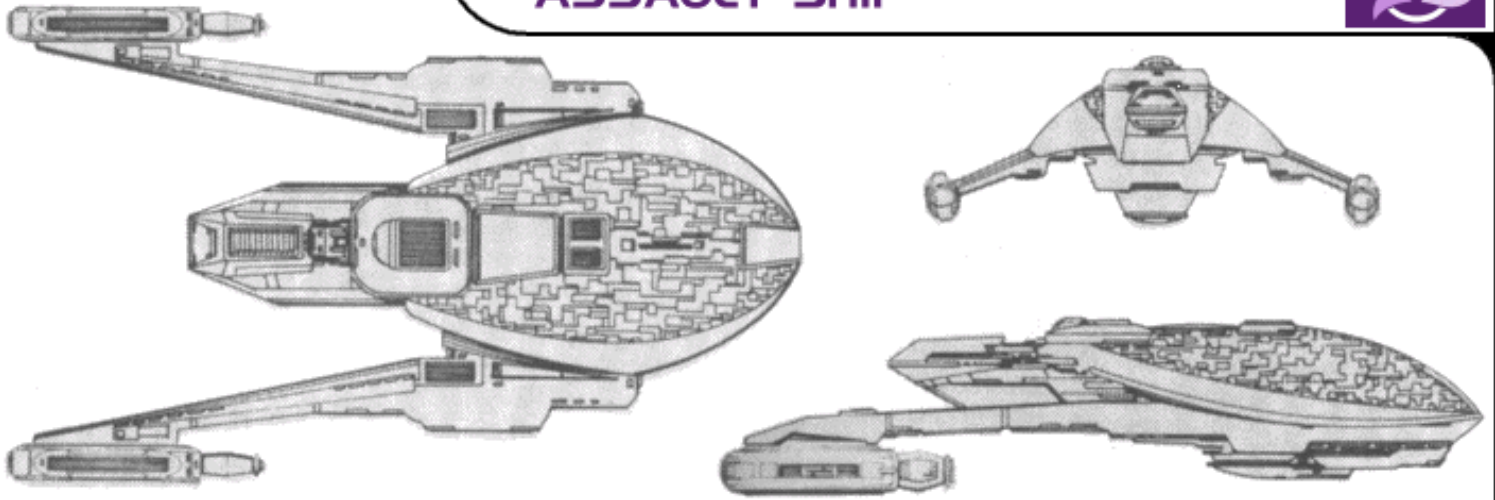

[Click here to view this ship in its own window](#)

BRAD'S COMMENTS: The third and final Klingon assault ship design from Knuston and Brown. It is perhaps the most radical departure from the typical Klingon design philosophy in the entire book. Only the placement of the standard-design Klingon warp nacelles gives any clue that this is a Klingon ship. Likewise, you have to really look hard at those engines to tell the ship's bow from her stern! Like the [T-3](#) and the [T-5](#), the T-12 is pure fiction and not part of the accepted Trek universe, as dictated by M. Okuda in his various Trek manuals. Nevertheless, it is kind of fun to imagine what a novel design like this would have looked like up on the big screen or even on television. In game play, the T-12 is similar to other assault ships: underpowered and undergunned. But she is much better off than her smaller cousins, the T-3 and T-5, and can hold her own against older cruiser designs NOT equipped with photon torpedo weaponry. As was suggested with the T-5, use the T-12 as window dressing during games that require taking over a planet as part of their primary goal. Or if you're the daring kind, pit a small group of T-12's against a battle force of older cruisers and/or frigates and see if you can't make strategy your primary weapon.



From the FASA Star Trek KLINGON SHIP RECOGNITION MANUAL, circa 1985

T-12 (Carrier of Doom) Class IX Assault Ship

Known Sphere Of Operation: conflict zones

Data Reliability: B

Major Data Source: Klingon Sector Intelligence.

The T-12 is the largest assault ship in the Klingon Navy. With the capability of putting its entire contingent of troops and vehicles on the ground in less than 15 minutes, this vessel is one of the most respected in known space. Its ability to beam down a total of 2,400 troops, 56 light support vehicles, and 28 heavy tanks in such a short period of time makes it very difficult for any enemy to repel this force. In most assault operations, these ships are used in groups of 3, the number of groups depending on the complexity of the operation.

The largest number of these vessels used in a single operation was on Stardate 2/2003 when the Klingons invaded and captured Mrzicann, a small world outside the Organiaan Treaty Zone. In this campaign, 24 T-12's beamed their troops and material onto the planet's surface with such speed and precision that the defenders were compelled to surrender in less than twelve hours. Mrzicann's standing army of 800,000 troops was overwhelmed by the element of surprise and, in most cases, gave up without any fight. To prevent a repeat of this occurrence, Star Fleet has stepped up its monitoring of these vessels, keeping track of their location and movements.

The T-12 is capable of traveling at a sustained speed of Warp 7, allowing it to be an integral part of any invading force. Due to the nature of its mission, the T-12 has better engine shielding than most Klingon vessels. This added shielding protects the troops from being overexposed to the radiation emitted by the warp and impulse systems.

These vessels carry an impressive array of eight disruptors, and so it would seem that these ships could stand and fight with most any warship. On closer examination, however, the range limitations of the KD-11 make it obvious that the weapons are only for close-in support.

Of the 102 T-12's built, 88 remain in active service, 2 are used by the Imperial Marine Training Command, and 12 have been destroyed. The T-12 is produced at Fonawl, Iosia, and Mustaka, with a combined production rate of 14 per year.

The class is named from the Klingon *na ra'den*, a typical reference to the strike force it can deliver so rapidly.

Construction Data:

Model Numbers-	A
Ship Class-	IX
Date Entering Service-	2/1406
Number Constructed	102

Hull Data:

Superstructure Points-	15
Damage Chart-	A
Size	
Length-	300 meters
Width-	170 meters
Height-	65 meters
Weight-	126,200 tons
Cargo	
Cargo Units-	3,200 units
Cargo Capacity-	160,000 tons
Landing Capability-	None

Equipment Data:

Control Computer Type-	ZD-6
Transporters-	
Standard 6-person-	8
Combat 22-person-	10
Emergency 18-person-	4
cargo small	8
large	4
Cloaking Device Type-	None
Power Requirement-	None

Other Data:

Crew-	82
Troops-	2,400
Shuttlecraft-	14

Engines and Power Data:

Total Power Units Available-	44
Movement Point Ratio-	4/1
Warp Engine Type-	KWE-3
Number-	2
Power Units Available-	20
Stress Charts-	J/M
Maximum Safe Cruising Speed-	Warp 7
Emergency Speed-	Warp 8
Impulse Engine Type-	KID-2
Power Units Available-	4

Weapons and Firing Data:

Beam Weapon Type-	KD-11
Number-	8
Firing Arcs-	2p, 2f, 2s, 2a
Firing Chart-	F
Maximum Power-	5
Damage Modifiers	
+3	
+2	(1 - 4)
+1	(5 - 8)

Shields Data:

Deflector Shield Type-	KSN
Shield Point Ratio-	2/3
Maximum Shield Power-	14

Defense Factor- 64.3**Weapon Damage Factor-** 13.6[<<<< GO BACK](#)**IMPORTANT NOTE:**

It is entirely possible that you have surfed to this page from an internet portal and are now viewing this page without frames. **The STSSTCSMU&A is best viewed from within its own set of frames**, so [click here to jump to the main STSSTCSMU&A web page](#) and then [see the site as it was meant to be seen!](#)

L-13 'FAT MAN' CLASS BATTLESHIP

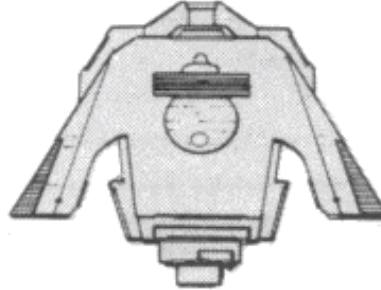
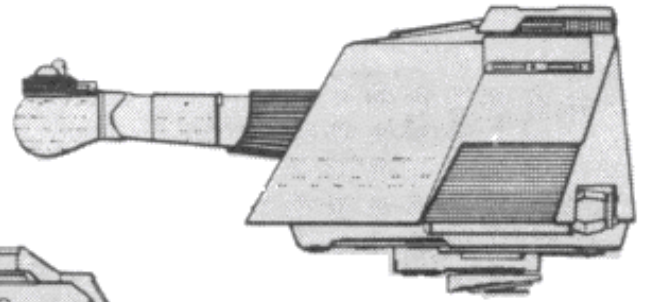
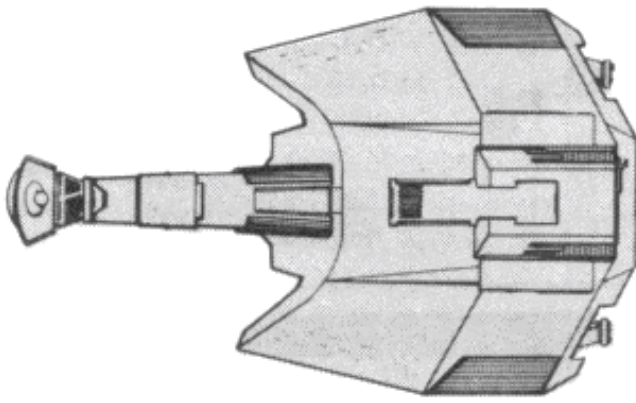

[Click here to view this class in its own window](#)

BRAD'S COMMENTS: This battlefield behemoth is as comical to play as it is to look at. At least when you use the A and C models. (The D model is fairly well off, but even then has some disadvantages.) Lumbering, underpowered, and lacking the punch of torpedoes, both A and C are a total joke. Which is why I think the L-13 is one of my favorites. Does this make sense? Let me explain...

You see, one of the great mistakes most amateur fan ship designers out there make is to create vessels that are INVINCIBLE! Paying no attention to real naval history, naval construction pragmatics, or any other sort of realism, they build these fantastic dreadnoughts with way too much power, way too many weapons, and way too much superstructure. Sure, such a beast is "fun" to fight with because you always win and you can clobber enemy ships at will.

But in the history of the REAL military, it happens quite often that good intentions go awry, and lead to the designing and commissioning of what I like to call 'lemons'. The L-13 is one big giant LEMON of a ship, and if you're any kind of real strategist or a gamer with a knack for being daring, you'll give the L-13 a couple of trial runs.

There is nothing more challenging than trying to win a match using tools you know are sub-standard. It forces you to be creative, and not just cruise up and bash your opponent to death. As I stated above, any fool can build a superduperstarship that nobody can beat. But what's the fun in that??? Yep. I like the L-13, as much for its clunky realism as for its unique challenges during game play.

The L-13 is also one of the first ships from the old FASA Klingon Starship manual that sports what I call "The TOS Look". Basically, this means that the L-13 is fairly slab-sided, not terribly intricate in appearance, and lends itself to the angular, simplistic ship designs that were common back in the 60's-era production of **ST:TOS**. Nothing fancy here. In fact, the artist went out of his way to make sure that the L-13 was indeed an oafish and ridiculous-looking vessel.

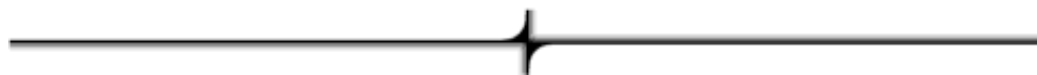

From the FASA Star Trek KLINGON SHIP RECOGNITION MANUAL, circa 1985

L-13 (Fat Man) Class IX-XI Battleship

Known Sphere Of Operation: Federation and Romulan Borders

Data Reliability: C

Major Data Source: Klingon Sector Intelligence

The L-13 was the first attempt by Klingon ship designers to construct a battleship. After the completion of four ships, with four more in various stages of production, it was discovered that the vessels were no better in combat than some of the existing cruisers and frigates.

On Stardate 2/1502, the first successful modification was commissioned, with the L-13C models superior in every respect. Their warp capabilities increased by 50%, allowing them to travel at Warp6. The KWE-2 gave them more efficient power for maneuvering and additional power for the weapons systems. The old KD-7 and KD-10 disruptors were replaced with the more effective KD-9, and the shields were improved and superstructure strengthened.

As the Federation and Romulans continued to upgrade their vessels, the Klingons did likewise. The L-13D, introduced on Stardate 2/2009 with the commissioning of two vessels, is equipped with the KWE-3 warp engine and KIF-2 impulse drive, highly efficient engines that give the ships even more power for maneuvering and weapons. Though the disruptor arrangement remains the same as the C model, the KP-6 torpedo has been added in both the fore and aft positions. This model also mounts more efficient shields and has an increased superstructure strength. The KCD cloaking device is reported to have been mounted on two of the four ships produced to date.

On Stardate 2/1403, an L-13A escorted by six D-11D's attacked a group of Romulan ships near the Triangle. The Romulan force consisted of a Type I V-6 (Gallant Wing) class cruiser and three Type 7 T-2 (Death Talon) class destroyers. The Klingon commander, confident with his new ship, pressed the attack, only to find the Romulan cruiser his equal. After several exchanges of fire, the Klingon force had suffered the loss of 3 D-11's, and serious damage had been done to the L-13. The Romulan cruiser had received moderate damage and one destroyer had been eliminated. The Klingons, fearing the loss of the battleship, began to withdraw from the battle. The Romulan commander decided to counterattack the retreating Klingons. The huge battleship still had plenty of fight left and was able to disable another of the Romulan destroyers. At this point, both sides disengaged; the Klingon ships withdrew to Klingon space while the

Romulan commander returned to the area of the battle and salvaged what he could of his ships, taking in tow a disabled D-11. This skirmish proved to the Klingon Imperial Command that the L-13 needed improvements. The B model was not successful during its tests and was therefore never put into production.

Of the 21 L-13's built, 20 remain in active service, and one A model is missing and presumed lost. The facilities for constructing the L-13 are located at Taamar and are estimated to produce up to two per year.

The class, named for the Klingon "k'el ri'anda", translates to "the dangerous fat man". The brunt of many jokes about being more dangerous to their Klingon crews than the enemy, the L-13 is known to Star Fleet officers as 'the fat man" and as "the turtle".

Construction Data:

Model Numbers-	A	C	D
Ship Class-	IX	X	XI
Date Entering Service-	1/1306	2/1502	2/2009
Number Constructed	8	9	4

Hull Data:

Superstructure Points-	30	32	34
Damage Chart-	C	C	C
Size			
Length-	242 meters	242 meters	244 meters
Width-	127 meters	127 meters	147 meters
Height-	110 meters	110 meters	110 meters
Weight-	123,300 tons	158,800 tons	164,300 tons
Cargo			
Cargo Units-	240 units	240 units	250 units
Cargo Capacity-	12,000 tons	12,000 tons	12,500 tons
Landing Capability-	None	None	None

Equipment Data:

Control Computer Type-	ZD-7	ZD-7	ZD-7
Transporters-			
Standard 6-person-	4	6	6
Combat 22-person-	8	8	8
Emergency 18-person-	2	2	2
cargo-	2	3	3
Cloaking Device Type-	None	None	KCD
Power Requirement-	None	None	48

Other Data:

Crew-	1,048	1,052	1,062
Troops-	392	420	420
Shuttlecraft-	12	14	16

Engines and Power Data:

Total Power Units Available-	41	53	63
Movement Point Ratio-	6/1	5/1	4/1
Warp Engine Type-	KWD-2	KWE-2	KWE-3
Number-	2	2	2
Power Units Available-	12	18	20
Stress Charts-	L/N	J/M	J/M
Maximum Safe Cruising Speed-	Warp 4	Warp 6	Warp 7
Emergency Speed-	Warp 6	Warp 8	Warp 8
Impulse Engine Type-	KIF-1	KIF-1	KIF-2
Power Units Available-	17	17	23

Weapons and Firing Data:

Beam Weapon Type-	KD-8	KD-8	KD-8
Number-	4	6	6
Firing Arcs-	2f/p, 2f/s	2f/p, 2f, 2f/s	2f/p, 2f, 2f/s
Firing Chart-	U	U	U
Maximum Power-	7	7	7
Damage Modifiers			
+3	(1 - 7)	(1 - 7)	(1 - 7)
+2	(8 - 15)	(8 - 15)	(8 - 15)
+1	(16 - 20)	(16 - 20)	(16 - 20)
Beam Weapon Type-	KD-7	KD-9	KD-9
Number-	3	5	5
Firing Arcs-	2f, 1a	1p/a, 3a, 1s/a	1p/a, 3a, 1s/a
Firing Chart-	L	W	W
Maximum Power-	7	5	5
Damage Modifiers			
+3		(1 - 7)	(1 - 7)
+2	(1 - 6)	(8 - 15)	(8 - 15)
+1	(7 - 12)	(16 - 20)	(16 - 20)
	KD-10		

Beam Weapon Type-	4		
Number-	1p/a, 2a, 1s/a		
Firing Arcs-	C		
Firing Chart-	3		
Maximum Power-			
Damage Modifiers			
+3			
+2	(1 - 6)		
+1			KP-6
Missile Weapon Type-			4
Number-			2f, 2a
Firing Arcs-			R
Firing Chart-			2
Power To Arm-			20
Damage-			

Shields Data:

Deflector Shield Type-	KSH	KSL	KSH
Shield Point Ratio-	1/3	1/3	1/3
Maximum Shield Power-	11	14	15

Defense Factor-	86.3	110.2	135.6
Weapon Damage Factor-	38.6	51.6	85.2

[<<<< GO BACK](#)

IMPORTANT NOTE:

It is entirely possible that you have surfed to this page from an internet portal and are now viewing this page without frames. **The STSSTCSMU&A is best viewed from within its own set of frames**, so [click here to jump to the main STSSTCSMU&A web page](#) and then [see the site as it was meant to be seen!](#)

L-20 CLASS FAST BATTLESHIP

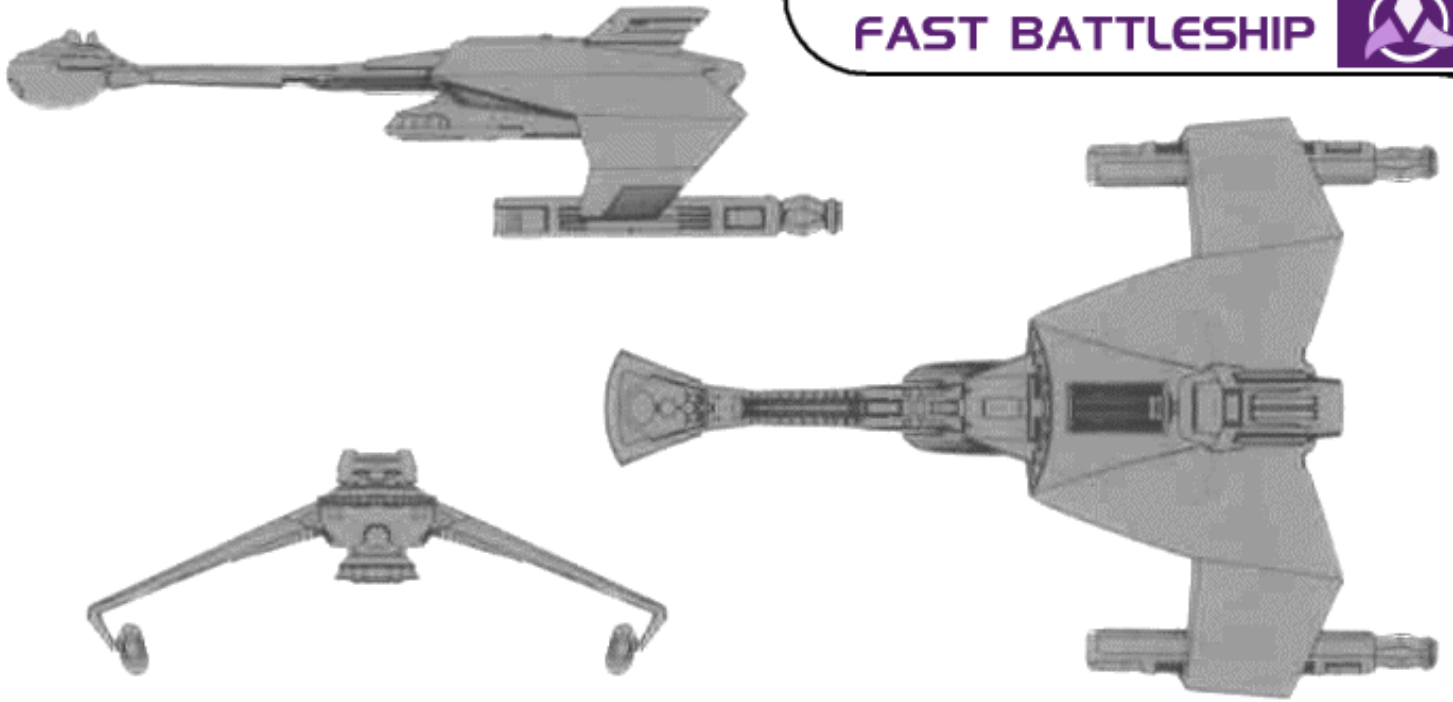

[Click here to view this ship in its own window](#)

BRAD'S COMMENTS: The stats for this sucker make it out to be even more deadly than the largest Klingon Kirk-era cruisers, like the [D-7M](#) and the [Riskadh](#). Sadly, I don't think the ship's outward appearance matches its internal ferocity. If the L-20 was edited from the pages of my edition of the game on account of looks, I can kind of understand why. It looks more like a light cruiser than it does a bona fide battleship, such as the imposing [L-24](#). Still, the stats are great and I can't wait to try this out in a game some time. It should kick butt. (the pic above is kind of grainy too, but I do the best I can with the scans I get from you fans.)

This is another rare design furnished by [Bernard Guignard](#); one of the first new Klingon designs added to the Klingon section in probably 8 months! Thanks Bernard!



From the FASA Star Trek Starship Tactical Combat Simulator, circa 1983 - 1986

Class design by: John J. Stevens & Forest Brown

L-20 Class X Fast Battleship

Notes: In the years following the abortive Federation/Klingon war of Organia, the Klingon High Command decided to design and construct a capital ship that would exceed the capabilities of any Federation vessel. Many officials believed the requirements were impossible to achieve, but when the Thoras Shipyards submitted their design, these same individuals were stunned. Here was a vessel that met and, in some cases, exceeded all the minimum standards. The L-20 designer, Captain Kangar sutai Kinzan, had proceeded under the assumption that, if cost was no consideration, anything was possible.

The L-20 prototype, the *Keth Ke Se*, was completed on Stardate 2/1504 and had the distinction of being the most expensive ship ever constructed for the Imperial Navy. This new battleship earned her name while on trials, when she single-handedly destroyed three Romulan vessels in the Triangle, taking no damage to herself. Her main batteries were capable of crippling the most powerful vessels then in service.

Heavy bow and stern torpedoes give the L-20 the ability to strike hard while still maintaining high speeds. An oversized impulse engine insures that the L-20 has plenty of maneuver power. Equipped with the best deflectors and shielding available at the time it was constructed, and given a strengthened superstructure, the L-20 prototype could take damage as well as give it. Design specifications called for Warp 6 capabilities, but the ship delivered went a step further with a speed of Warp 7.

An interesting addition to the lower hull is an assault shuttle bay, which adjoins the staging area for the main transporters. This assures that a landing by the ship's compliment of 350 marines need not be halted by transporter failure or the need to maintain shielding. The most devastating feature of the L-20 is its basic resemblance to the famed D-7 cruiser, which could lead to tragic mistakes on the part of an opposing captain.

Construction Data:

Model Numbers-	A
Ship Class-	X
Date Entering Service-	2/1504
Number Constructed	unknown

Hull Data:

Superstructure Points-	30
Damage Chart-	C
Size	
Length-	250 meters
Width-	181 meters
Height-	70 meters
Weight-	156,380 tons
Cargo	
Cargo Units-	300 units
Cargo Capacity-	15,000 tons
Landing Capability-	None

Equipment Data:

Control Computer Type-	ZD-7
Transporters-	
Standard 6-person-	5
Combat 20-person-	4
Emergency 18-person-	2
cargo small	1
large	1
Cloaking Device Type-	none
Power Requirement-	none

Other Data:

Crew-	487
Troops-	350
Shuttlecraft-	6

Engines and Power Data:

Total Power Units Available-	53
Movement Point Ratio-	4/1
Warp Engine Type-	KWE-3
Number-	2
Power Units Available-	20
Stress Charts-	J/M
Maximum Safe Cruising Speed-	Warp 7
Emergency Speed-	Warp 8
Impulse Engine Type-	KIF-2
Power Units Available-	23

Weapons and Firing Data:

Beam Weapon Type-	KD-12
Number-	4 in two banks
Firing Arcs-	2f/p, 2f/s
Firing Chart-	H
Maximum Power-	5
Damage Modifiers	
+3	(1 - 3)
+2	(4 - 8)
+1	(9 - 12)
Beam Weapon Type-	KD-8
Number-	4 in two banks
Firing Arcs-	2f, 2a
Firing Chart-	U
Maximum Power-	7
Damage Modifiers	
+3	(1 - 7)
+2	(8 - 16)
+1	(17 - 20)
Missile Weapon Type-	KP-4
Number-	3
Firing Arcs-	2f, 1a
Firing Chart-	Q
Power To Arm-	2
Damage-	18

Shields Data:

Deflector Shield Type-	KSL
Shield Point Ratio-	1/3
Maximum Shield Power-	14

Defense Factor-

unknown

Weapon Damage Factor-

unknown

[<<<< GO BACK](#)

IMPORTANT NOTE:

It is entirely possible that you have surfed to this page from an internet portal and are now viewing this page without frames. **The STSSTCSMU&A is best viewed from within its own set of frames**, so [click here to jump to the main STSSTCSMU&A web page](#) and then [see the site as it was meant to be seen!](#)

D-10 'RISKADH' CLASS CRUISER

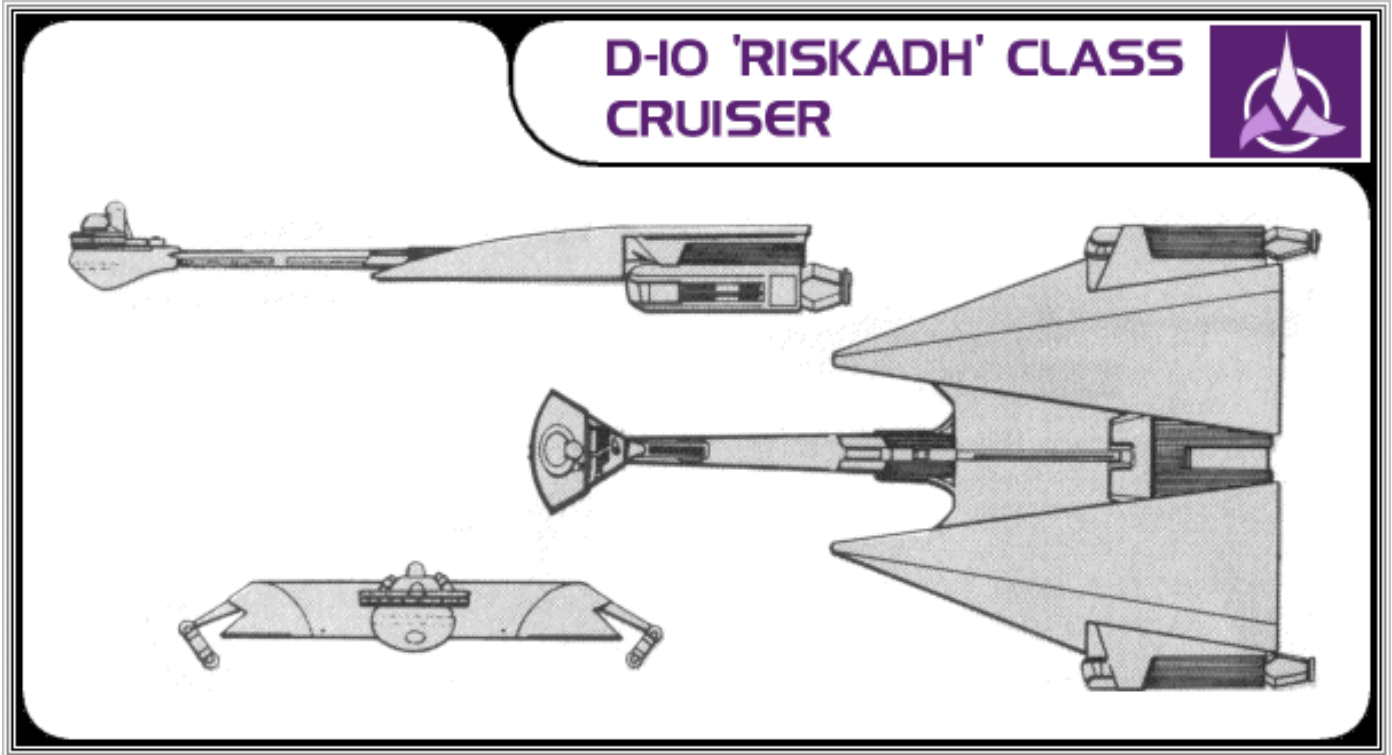

[Click here if you would like to view this ship in its own window](#)

BRAD'S COMMENTS: A very fun ship to play! Especially the later models, which have a decent balance of firepower and defensive oomph. The styling of the D-10 is also like that of the [L-13 'Fat Man'](#) in that this cruiser has a very slab-sided **ST:TOS** feel to it.

As always, this ship has no basis in official Trek canon and has never been seen in any movie or series as far as I know. Its distinctive wedge-shaped wings would make it stand out on screen, so I don't think I've seen anything even remotely resembling the D-10 on any of the films or on any of the series.

In FASA lore, this ship is pretty storied, especially where the so-called 'Four Years War' is concerned. In actual game use, this ship is a great match for the big Federation or Romulan cruisers. Especially the later models.

Packing a nice punch with powerful torpedoes and strong superstructure, I've had a lot of success with the D-10 ship over the years. It's even more fun playing one or two Riskadh-class ships against a host of smaller, weaker opponents, because you have to think on your feet and use your potent weaponry wisely, otherwise you're liable to expend all your power chasing around the smaller ships while they slowly bleed you to death with phaser or disruptor attacks.

One thing that always annoyed me was that this ship was one of the few ships originally listed in the main game manual that came with the STSSTCS boxed set, but my boxed set had no D-10 playing pieces!! I must have searched for two hours through all those cardboard hexagons back in 1989, looking in vain for the D-10. Eventually I just gave up and had to hand-make some D-10 playing pieces using the photocopy-ready sheet out of the back of the book. I'm not sure if my boxed set was a fluke, and was missing the D-10s on accident, or if this was just an oversight at FASA. I suspect the latter.



From the FASA Star Trek KLINGON SHIP RECOGNITION MANUAL, circa 1985

D-10 (Riskadh) Class VIII - X Cruiser

Known sphere Of Operation: Empire-wide use

Data Reliability: A for models A, D, and G; B for model F, D for model H.

Major Data Source: Models A, D, and G are in Star Fleet possession; Klingon Sector Intelligence

On Stardate 1/9606, the D-10 cruiser, the design of which was strongly influenced by the D-7, was commissioned into service. The Klingon Imperial Command hoped to counter Star Fleet's Constitution class cruisers with this new vessel. The Four Years War was in its second year, and the Klingons had learned some of their lessons well. The D-10 featured a sturdy superstructure and the most effective shields the empire had to offer. The fore and aft-mounted disruptors were far superior to the Federation lasers, but were not as destructive as the Federation's accelerator cannons.

The D-10 used the same command pod as the D-7, thus eliminating the need for additional production facilities. Like the D-7s pod, that of the D-10 is capable of being jettisoned and has similar sub-light maneuvering and life support capabilities. On Stardate 1/9802, Star Fleet captured a pod that had been jettisoned during the Battle of Kesse 16 months earlier; the crew were alive and as well as could be expected.

The main hull of the early D-10s contain the engineering section, shuttlebays, crew quarters, and assault troop hypothermia capsules; later models have no troop-carrying capabilities but instead have large research facilities. The warp engines are mounted on short pylons and are jettisonable. With the additional removal of the hypothermia capsules, the ship is capable of running on its impulse power alone for up to one year. The shuttle hangars are located on the upper wing surface of the main hull and are seen as two large doors. Directly aft of these doors are located the aft firing disruptors; aft-firing photon torpedo tubes are located at the stern of the vessel just below the impulse exhaust port.

The D-10 is the only Klingon warship whose class name honors a Klingon family line: the Riskadh line, which died with its founder, Kahless the Unforgettable, the greatest of all emperors. D-10s are manufactured at the Taamar, Gnuu Re', Fonawl, Z'hai, and Mustaka facilities. The combined production rate is 14 D-10Ds, 12 D-10Gs, and 10 D-10Hs per year.

The D-10A first entered service on Stardate 1/9606, the first ships being rapidly sent into the Four Years War, where they proved to be the most powerful and feared ships in the Klingon Imperial Navy.

The model used a powerful warp engine, but mounted a fairly weak impulse system, the only real shortcoming of the vessel; the main engines allowed the ships to cruise at Warp 6, with emergency speeds as high as Warp 8. The weapons system consisted of six individually-mounted KD-6 disruptors and two aft-mounted KD-3s, giving the cruiser an offensive range capability 80,000 km greater than Federation warships.

With the Klingons having range superiority, if it had not been for the superior tactics of the Star Fleet commanders, the Four Years War might have turned out much differently. Star Fleet commanders were able to neutralize the range superiority in many cases, however. Klingon tactics were to send a D-10 with a small escort of three-to six destroyers into a system to secure it. Federation commanders would leave the system, making it appear unprotected; they would then return from several different directions and take the unsuspecting Klingons in flanking attacks. This tactic was not always successful, but it did deter the Klingons from mounting many attacks into the interior of Federation space. In the last months of the war, the Klingons faced the newly-developed phaser and photon torpedo, and the days of the D-10 as the "Queen Of Battle" were over.

Of the 444 D-10As built, 27 are in reserve fleets, 268 have been converted to D models and 14 to F models, 106 have been destroyed, 8 have been captured (6 by Star Fleet and 2 by the Romulans), 6 are listed as missing, 7 have been scrapped, 6 have been sold to ranking families within the Empire, and 2 have been sold to private interests in the Triangle.

The first modification to the D-10 came on Stardate 2/ 1012, when the KIB-2 impulse drive system was replaced with the KID-2. Though the new D-10B was ordered into production, it never was produced in numbers because the KWE-2 warp drive system was brought into the navy's inventory just as the new 8 models were ready for installation of their warp drives. These engines were installed, and, on Stardate 2/1201, the first D-10C was taken out for maneuver trials. On Stardate 6 2/1205, the completed ships were outfitted with the newly-created KD-9 disruptors, KP-4 photon torpedo, and the KSO shield systems, replacing the original equipment with upgraded systems. The D-10D entered service on Star- date 2/1307 with the simultaneous commissioning of 23 ships, the largest number of new ships to be commissioned at one time in known space.

The KWE-2 warp drive system allows the D-10D to achieve cruising speeds of Warp 7 and emergency speeds of Warp 8, even though it adds 30,000 mt to the overall weight. The KD-9 disruptors produce slightly less damage than the KD-6 models found on the D-10A, but they have an increased range of 20,000 km. The real increase in weapons power lies in the KP-4 torpedo, which is mounted fore and aft. The addition of so many new systems required an in- crease in the superstructure strength.

Of the 455 D-10Ds built, 389 remain in active service, 2 are used as training vessels, 47 have been destroyed, 2 have been captured by Star Fleet, 6 are listed as missing, 2 have been scrapped, 1 has been traded to the Romulans, 1 sold to the Orions, and 5 are in the service of ranking families of the Empire.

During the years 2/1002 to 2/1410, the Klingons created 5 new warp drive engines, 2 impulse drive systems, 5 new disrupter types, 4 photon torpedo types, 5 shield systems (of which 2 used a trinary powertransformer), and 2 powerful computer systems. With all these new systems, the D-10F, incorporating many of them, was inevitable; it was commissioned on Stardate 2/1410. The KWE-3 engines produce 10% more power, and the KIE-1 impulse drive systems produce 50% more power than the systems installed on the D models, adding maneuverability. On Stardate 2/1312, the Klingons had acquired 14 Romulan plasma weapons of the RPL-1 type, and these weapons also were installed on the D-10F, instead of the photon torpedo. The KD-9 disruptors were replaced with KD-13s, increasing the range another 20,000 km, and the aft-firing KD-3s were replaced by 2 KD-9s and 2 KD-5s. The superstructure strength was increased by 16%, and the shields were upgraded.

After the completion of the D-10F models, the Klingons continued to use the Z'hai facility to construct D-10Gs, with two changes from the F model. The hypothermia capsules were removed and the area rebuilt as a laboratory facility, allowing the D-10G to act as a research cruiser in hostile areas where lightly-armed ships like the D-9 could be easily destroyed or damaged if attacked while alone. To further augment weaponry, fore and aft-firing photon torpedo bays were installed for the KP-4 torpedo.

On Stardate 2/2009, the D-10H was commissioned, the first model that has an exterior change. Instead of mounting the old style command pod, the ship mounted the command pod from the L-9 frigate, making the class easier to identify on visual scan but a more potent adversary. This model mounts the new KIE-2 impulse drive system, giving it more maneuvering power than most ships in either the Romulan Navy or Star Fleet. The disruptors were all refitted to KD-1 3s, not only to give the vessels a longer range of fire in all directions but also to ease the maintenance chore. The photon torpedo bay was converted to fire the new KP-6, which causes as much damage as any of those employed by Star Fleet and twice the damage as any used by the Romulans. With this array of weapons, and with its strengthened superstructure, the D-10H is, by far, the most powerful of the class and also stronger than most others in space.

Construction Data:

Model Numbers-	A	D	F	G	H
Ship Class-	VIII	X	X	X	X
Date Entering Service-	1/9606-2/1801	2/1307	2/1410	2/1601	2/2009
Number Constructed	444	455	14	84	32

Hull Data:

Superstructure Points-	22	24	28	28	30
Damage Chart-	C	C	C	C	C
Size					
Length-	262 meters	264 meters	266 meters	264 meters	264 meters
Width-	157 meters	157 meters	157 meters	157 meters	157 meters
Height-	30 meters	32 meters	32 meters	30 meters	30 meters
Weight-	104,800 tons	142,400 tons	143,800 tons	151,510 tons	154,250 tons
Cargo					
Cargo Units-	245 units	240 units	200 units	320 units	320 units
Cargo Capacity-	12,250 tons	12,000 tons	10,000 tons	16,000 tons	16,000 tons
Landing Capability-	None	None	None	None	None

Equipment Data:

Control Computer Type-	ZD-5	ZD-6	ZD-7	ZD-7	ZD-7
Transporters-					
Standard 6-person-	4	4	4	4	4
Combat 22-person-	6	6	5	5	5
Emergency 18-person-	1	1	1	1	1
cargo-	2	2	2	2	2
Cloaking Device Type-	None	None	None	None	None
Power Requirement-	None	None	None	None	None

Other Data:

Crew-	505	520	532	525	530
Troops-	320	320	240	220	110
Shuttlecraft-	10	10	8	12	12

Engines and Power Data:

Total Power Units Available-	38	40	46	46	52
Movement Point Ratio-	4/1	4/1	4/1	4/1	4/1
Warp Engine Type-	KWD-1	KWE-1	KWE-3	KWE-3	KWE-3
Number-	2	2	2	2	2
Power Units Available-	18	18	20	20	20
Stress Charts-	L/N	J/M	J/M	J/M	J/M
Maximum Safe Cruising Speed-	Warp 6	Warp 7	Warp 7	Warp 8	Warp 8
Emergency Speed-	Warp 8	Warp 8	Warp 8	Warp 9	Warp 9
Impulse Engine Type-	KIB-2	KID-2	KIE-1	KIE-1	KIE-2
Power Units Available-	2	4	6	6	12

Weapons and Firing Data:

Beam Weapon Type-	KD-6	KD-9	KD-13	KD-13	KD-13
Number-	6	6	8	8	10
Firing Arcs-	2f/p, 2f, 2f/s	2f/p, 2f, 2f/s	2f/p, 2f, 2f/s, 2a	2f/p, 2f, 2f/s, 2a	2f/p, 2f, 2f/s, 4a
Firing Chart-	T	W	X	X	X
Maximum Power-	6	5	5	5	5
Damage Modifiers					
+3		(1 - 8)	(1 - 7)	(1 - 7)	(1 - 7)
+2	(1 - 18)	(9 - 15)	(8 - 15)	(8 - 15)	(8 - 15)
+1		(16 - 22)	(16 - 22)	(16 - 22)	(16 - 22)
Beam Weapon Type-	KD-3	KD-3	KD-5	KD-5	
Number-	2	2	2	2	
Firing Arcs-	A	A	A	A	
Firing Chart-	I	I	P	P	
Maximum Power-	5	5	4	4	
Damage Modifiers					
+3			(1 - 10)	(1 - 10)	
+2			(11 - 18)	(11 - 18)	
+1	(1 - 11)	(1 - 11)			
Missile Weapon Type-		KP-4	RPL-1	KP-4	KP-6
Number-		2	1	2	2
Firing Arcs-		1f, 1a	F	1f, 1a	1f, 1a
Firing Chart-		Q	E	Q	Q
Power To Arm-		2	10	2	2
Damage-		18	See Chart	18	20

Shields Data:

Deflector Shield Type-	KSJ	KSO	KSL	KSL	KSL
Shield Point Ratio-	2/3	1/2	1/3	1/3	1/3
Maximum Shield Power-	12	15	14	14	14
Defense Factor-	69	85.3	102.5	107.5	118.3
Weapon Damage Factor-	36	45.2	55.7	61.6	68.8

[<<<< GO BACK](#)

IMPORTANT NOTE:

It is entirely possible that you have surfed to this page from an internet portal and are now viewing this page without frames. **The STSSTCSMU&A is best viewed from within its own set of frames**, so [click here to jump to the main STSSTCSMU&A web page](#) and then [see the site as it was meant to be seen!](#)

L-24 'EVER VICTORIOUS' CLASS BATTLESHIP

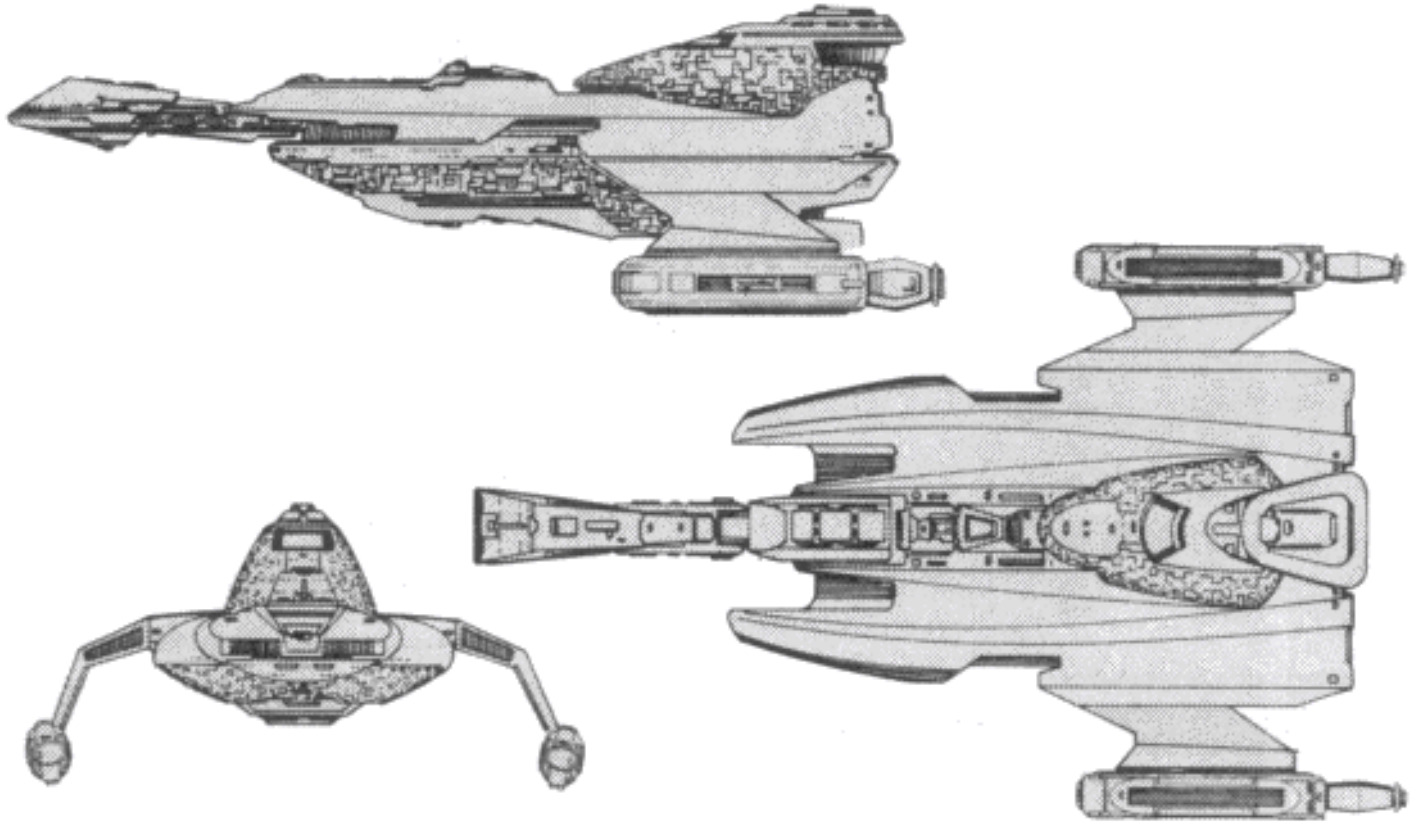

[Click here to view this class in its own window](#)

BRAD'S COMMENTS: Though the FASA game pre-dates **ST:TNG** by at least 2 to 4 years, the L-24, in my opinion, is one of the only ships out of the entire book that really looks like it belongs to the **ST:TNG** universe. In fact, it looks so similar to the **ST:TNG** era Vor'cha Attack Cruiser that, when I first saw the Vor'cha in action, I thought it WAS an L-24! Sadly, I later learned that the TV writers paid no attention whatsoever to the dead FASA booklets, and my hopes for an actual tie-in between the TV series and STSSTCS were dashed.

Nevertheless, it was fun to play the L-24 as if it belonged to TNG. Especially when pitted against a Federation [Excelsior](#), which makes countless appearances throughout **ST:TNG** and **ST:DS9**.

The L-24 is a well-designed craft that pushes the antiquated STSSTCS design rules to their limits. In essence, the L-24 is the apex of those old Klingon design charts, just as the Excelsior is the apex of the Federation charts. And matched head-to-head, the L-24 and Excelsior are about as Even Steven as you can get. Even better than the matchup posed by the Romulan [Z-1 Battleship](#). I also like the fact that the writers of the book limit the numbers of the L-24 in the Empire. Thus, the writers avoid another pitfall of amateur fan ship designers: infinite production runs.

Amateur fan ship designers are notorious for writing ship histories in which their favorite home-made ship classes are produced by the thousands. Especially overly powerful ships! But in reality, such impressive craft are going to be terribly expensive to build and maintain. Just look at the modern sea navies of the world. There are precious few true Battleships out there. The U.S. Navy itself only has 4 battleships left, and they've been in a constant rotation of activation/de-activation ever since the end of World War 2. The same should be true of the Star Trek universe, where even advanced technology and automation have their limits. Hence, you don't see thousands of [Galaxy Class](#) starships flying around the Federation, and you certainly don't read about thousands of L-24's in terms of the FASA game history.

One final note. The Klingon Ship Recognition Manual lists only one variant of this design, that being the A model. The STSSTCS main game manual also lists a second model, the B, which I have included here. Like the Type 2 of the Romulan Z-1, the B model of the L-24 is superior to its predecessor in terms of weaponry and superstructure.

L-24 (Ever-Victorious) Class XIII Battleship

Known Sphere Of Operation: Federation Border

Data Reliability: D

Major Data Source: Klingon Sector Intelligence, Operation Dixie

The L-24 is the largest warship in the Klingon navy. These mammoth ships were commissioned into service prior to the testing of the Federation battleship Excelsior. For a short period of time, the balance of power along the borders turned in favor of the Klingons.

The battleship uses the most powerful warp and impulse engines in the Klingon inventory. The combination of these power plants gives these vessels a highly efficient maneuver ratio and allows them to sustain speeds of Warp 6 for long periods of time. The warp engines are mounted on pylons to keep them from the main hull of the ship, and, as with most newer designs, they can be jettisoned in case of emergency. The L-24 differs from other Klingon ships regarding the shielding provided to the engineering technicians. Most other Klingon vessels have minimal engine shielding, and servitor races are trained to operate this equipment; in the L-24, Klingon citizens operate the engines.

The L-24 mounts eight KD-8 disruptors in banks of two, and four KD-13 disruptors. The KD-8's are mounted two banks on the command pod and two banks on the main hull. The KD-13's are mounted on the rear of the main hull. The battleship can fire as many as ten disruptors and two photon torpedoes in some areas of the forward arc, giving this ship a definite advantage in most situations. The KP-6 torpedo, which is mounted in both the fore and aft positions, can inflict as much damage as the most powerful torpedo in the Federation arsenal.

The interior of the battleship is compartmented to reduce the dangers of decompression during battle. This makes the structural integrity of the ship much greater, as seen by the high superstructure strength rating. The deflector shielding for the L-24 is the best the Klingons can produce at this time.

The bridge is located in the forward pod. This typical Klingon bridge design is capable of being separated from the main hull in case of emergency. The bridge of the L-24 has an auxiliary impulse engine that can be used only after separation; it gives the command pod the ability to travel short distances and allows a minimum of maneuvering. The pod mounts two of the KD-8 disruptor banks, which are capable of firing in all directions when separated from the main hull. Also mounted in the pod is a torpedo bay capable of firing torpedoes, though the torpedo storage is minimal.

Like most Klingon warships, this vessel carries assault troops. The 480 troops and their eight light support vehicles are capable of being transported to the ground in less than seven minutes.

As of Stardate 2/2306, only two L-24's have been commissioned into service. Both vessels have been scanned along the Federation border and are known to be working that area. Intelligence gathered from Operation Dixie suggests that new L-24's will be stationed along the Romulan and Triangle borders in the near future.

Further data gained by Operation Dixie shows that these battleships will be produced at two facilities. The first models have been manufactured at the Taamar shipyard, and it is believed that the second facility is being constructed at Gnuu.

The class is named from the Klingon "komo val", which translates to "always in victory."

Construction Data:

Model Numbers-	A	B
Ship Class-	XIII	XIII
Date Entering Service-	2/2204	2/2306
Number Constructed	2	(classified)

Hull Data:

Superstructure Points-	38	50
Damage Chart-	C	C
Size		
Length-	320 meters	320 meters
Width-	190 meters	190 meters
Height-	105 meters	105 meters
Weight-	214,000 tons	230,000 tons?
Cargo		
Cargo Units-	300 units	300 units
Cargo Capacity-	15,000 tons	15,000 tons
Landing Capability-	None	None

Equipment Data:

Control Computer Type-	ZD-8	ZD-8
Transporters-		
Standard 6-person-	8	8
Combat 22-person-	10	10
Emergency 18-person-	2	2
cargo-	4	4
Cloaking Device Type-	NONE	NONE
Power Requirement-	NONE	NONE

Other Data:

Crew-	1,070	1,090
Troops-	480	480
Shuttlecraft-	20	20

Engines and Power Data:

Total Power Units Available-	79	79
Movement Point Ratio-	5/1	5/1
Warp Engine Type-	KWG-1	KWG-1
Number-	2	2
Power Units Available-	28	28
Stress Charts-	I/M	I/M
Maximum Safe Cruising Speed-	Warp 6	Warp 6
Emergency Speed-	Warp 8	Warp 8
Impulse Engine Type-	KIF-2	KIF-2
Power Units Available-	23	23

Weapons and Firing Data:

Beam Weapon Type-	KD-8	KD-13
Number-	8	16 total
Firing Arcs-	4f/p, 4f/s	4f/p, 4f/s, 4p/a, 4s/a
Firing Chart-	U	X
Maximum Power-	7	5
Damage Modifiers		
+3	(1 - 7)	(1 - 7)
+2	(8 - 15)	(8 - 15)
+1	(16 - 20)	(16 - 22)
Beam Weapon Type-	KD-13	
Number-	4	
Firing Arcs-	2p/a, 2s/a	
Firing Chart-	X	
Maximum Power-	5	
Damage Modifiers		
+3	(1 - 7)	
+2	(8 - 15)	
+1	(16 - 22)	
Missile Weapon Type-	KP-6	KP-6
Number-	4	6
Firing Arcs-	2f, 2a	2f, 2a, 1p, 1s
Firing Chart-	R	R
Power To Arm-	2	2
Damage-	20	20

Shields Data:

Deflector Shield Type-	KSP	KSP
Shield Point Ratio-	1/3	1/3
Maximum Shield Power-	15	15

Defense Factor-	153.3	170.5
Weapon Damage Factor-	95.2	162.0

[<<<< GO BACK](#)

IMPORTANT NOTE:

It is entirely possible that you have surfed to this page from an internet portal and are now viewing this page without frames. **The STSSTCSMU&A is best viewed from within its own set of frames**, so [click here to jump to the main STSSTCSMU&A web page](#) and then [see the site as it was meant to be seen!](#)

KDF-2 K'MIRRA CLASS BATTLESHIP

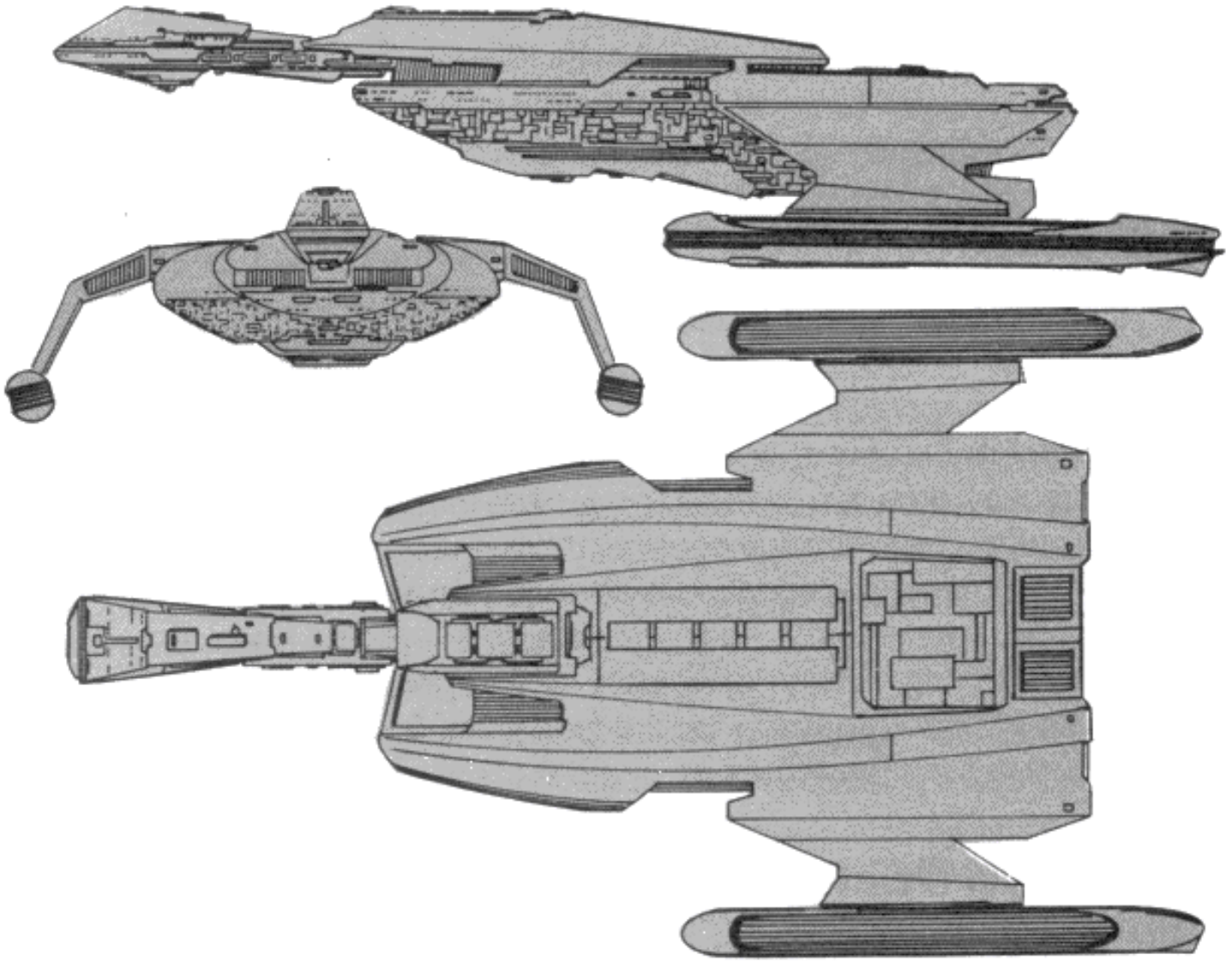

[Click here to view this ship in its own window](#)

BRAD'S COMMENTS: I said before that I thought the [L-24](#) looked like it belonged in **ST:TNG**. Well, with the publication of the now-apocryphal **ST:TNG** Officer's Manual, the guys at FASA proved me right! The KDF-2 is an obvious redressing of the L-24 Battleship (not the [K'tinga D7](#) cruiser) with only the addition of the [Excelsior](#)-style warp nacelles and the absence of the aft 'hump' making the KDF-2 look any different from the L-24. Also like the L-24, the KDF-2 looks a hell of a lot like the **ST:TNG/DS9** [Vor'cha](#) Attack Cruiser. Compare the silhouette of the KDF-2 with the silhouette of the Vor'cha in the official Star Trek Encyclopedia by M. Okuda, and you'll find they are very similar. Perhaps Sternbach and his crew occasionally glanced at the FASA manuals after all??? Nah! That's too much to hope for.

The overly powerful stats for the KDF-2 are as bogus as the rest of the poor TNG Officer's Manual. The writers tried as best as they could to extrapolate from the then year-old TNG television series, and make it mesh with already-printed FASA materials. But it does not hold water. There is no Transwarp revolution, hence there can be no Klingon--or Federation--Transwarp cruisers or battlecruisers. All official Trek canon suggests that Transwarp was a dismal failure, and that the only reason the Excelsior survived and thrived at all is because the spaceframe itself was sound. There should be no 'special' engine nacelles attached to the KDF-2. Also, **TNG** and **DS9** history makes it seem as though the actual technology exchanged between the Federation and the Klingons is much, much more limited than the FASA TNG Officer's Manual states. There should be no Federation phaser weaponry installed on a Klingon battlecruiser, and there should be no attention paid to 'creature comforts' aboard a Klingon craft, as the Officer's Manual supposes.

In the end, the KDF-2 is perhaps even more estranged from official Trek canon than its older counterparts from the 1985 Klingon Ship Recognition Manual because, like just about everything else in the TNG Officer's Manual, the KDF-2 has been rubbed out by current writing. M. Okuda's brilliant Encyclopedia and Chronology, and Sternbach's NCC-1701-D Technical Manual, obliterate any notion that the KDF-2 could have a basis in Trek fact. It's really too bad, too, because the TNG Officer's Manual was a great read in it's day, ten years ago. Just like "Mr. Scott's Guide to the Enterprise". But that was before FASA lost its contract with Paramount, and the producers of **TNG/DS9/VOY** chose to chart an entirely different

course; one that NOT adhere to or support any written material that did not come directly from themselves.

So we're left to play with the KDF-2 and imagine what it would have been like to see it gracing the small screen. During game play, the KDF-2 is a total brute, capable of delivering awful blows and absorbing terrible damage without flinching. The superstructure rating is especially over the top, and unless you stack a single KDF-2 against MULTIPLE and POWERFUL opponents from the older KLINGON, FEDERATION, or ROMULAN manuals, the KDF-2 is going to steal the show every time. The only ships that come close to the KDF-2 are the Romulan [D'Daridex](#) Battlecruiser, the Federation [Galaxy Class](#), and the [Ferengi Marauder](#) ships. All of which have similarly bloated and similarly bogus stats listed in the FASA TNG Officer's Manual.



From the FASA Star Trek: The Next Generation Officer's Manual, circa 1988

KDF-2 (Alliance) Class XIV Battlecruiser

Known Sphere Of Operation: Empire-wide Use

Data Reliability: A

Major Data Source: Grand Alliance Data Files

Based on the old Imperial Klingon Navy "K'tinga" Class battlecruiser, the Alliance Class is a transwarp-drive capable fire platform of considerable firepower and durability. This firepower, which includes imported Federation technology, has not been acquired at the expense of individual crew comforts, reflecting the willingness of KDF naval designers to adapt proven Starfleet approaches to naval architecture. The largest and most formidable of all vessels currently serving the Klingon Defense Force, the Alliance Class is also proof of the mutual cooperation and trust that exists between the Free Worlds of Klinzai and the United Federation of Planets.

Construction Data:

Model Numbers-	KDF-2
Ship Class-	XIV
Date Entering Service-	3/0001
Number Constructed	125

Hull Data:

Superstructure Points-	128
Damage Chart-	C
Size	
Length-	385 meters
Width-	89 meters
Height-	75 meters
Weight-	294,125 tons
Cargo	
Cargo Units-	100 units
Cargo Capacity-	5,000 tons
Landing Capability-	None

Equipment Data:

Control Computer Type-	Classified
Transporters-	
Standard 4-person-	10
Combat 10-person-	5
cargo, large-	4
cargo, small-	2
Cloaking Device Type-	NONE
Power Requirement-	NONE

Other Data:

Crew-	400
KDF Marines-	125
Shuttlecraft-	6

Engines and Power Data:

Total Power Units Available-	112
Movement Point Ratio-	6/1
Warp Engine Type-	KTWD-1
Number-	2
Power Units Available-	40
Stress Charts-	E/F
Maximum Safe Cruising Speed-	Warp 12
Emergency Speed-	Warp 14
Impulse Engine Type-	KIL-3
Power Units Available-	32

Weapons and Firing Data:

Beam Weapon Type-	FH-11
Number-	6
Firing Arcs-	2f/p/s, 2p/a, 2s/a
Firing Chart-	Y
Maximum Power-	10
Damage Modifiers	
+3	(1 - 10)
+2	(11 - 17)
+1	(18 - 24)
Beam Weapon Type-	KDR-5
Number-	10
Firing Arcs-	4f, 2f/p/s, 2p, 2s
Firing Chart-	S
Maximum Power-	8
Damage Modifiers	
+3	(1 - 8)
+2	(9 - 14)
+1	(15 - 18)
Missile Weapon Type-	KRP-10
Number-	8
Firing Arcs-	4f, 4 360 degree arc, 2a
Firing Chart-	Q
Power To Arm-	1
Damage-	15

Shields Data:

Deflector Shield Type-	KST
Shield Point Ratio-	1/4
Maximum Shield Power-	17

Defense Factor- 244.4

Weapon Damage Factor- 229.2

[<<<< GO BACK](#)

IMPORTANT NOTE:

It is entirely possible that you have surfed to this page from an internet portal and are now viewing this page without frames. **The STSSTCSMU&A is best viewed from within its own set of frames**, so [click here to jump to the main STSSTCSMU&A web page](#) and then [see the site as it was meant to be seen!](#)

VOR'CHA CLASS BATTLECRUISER

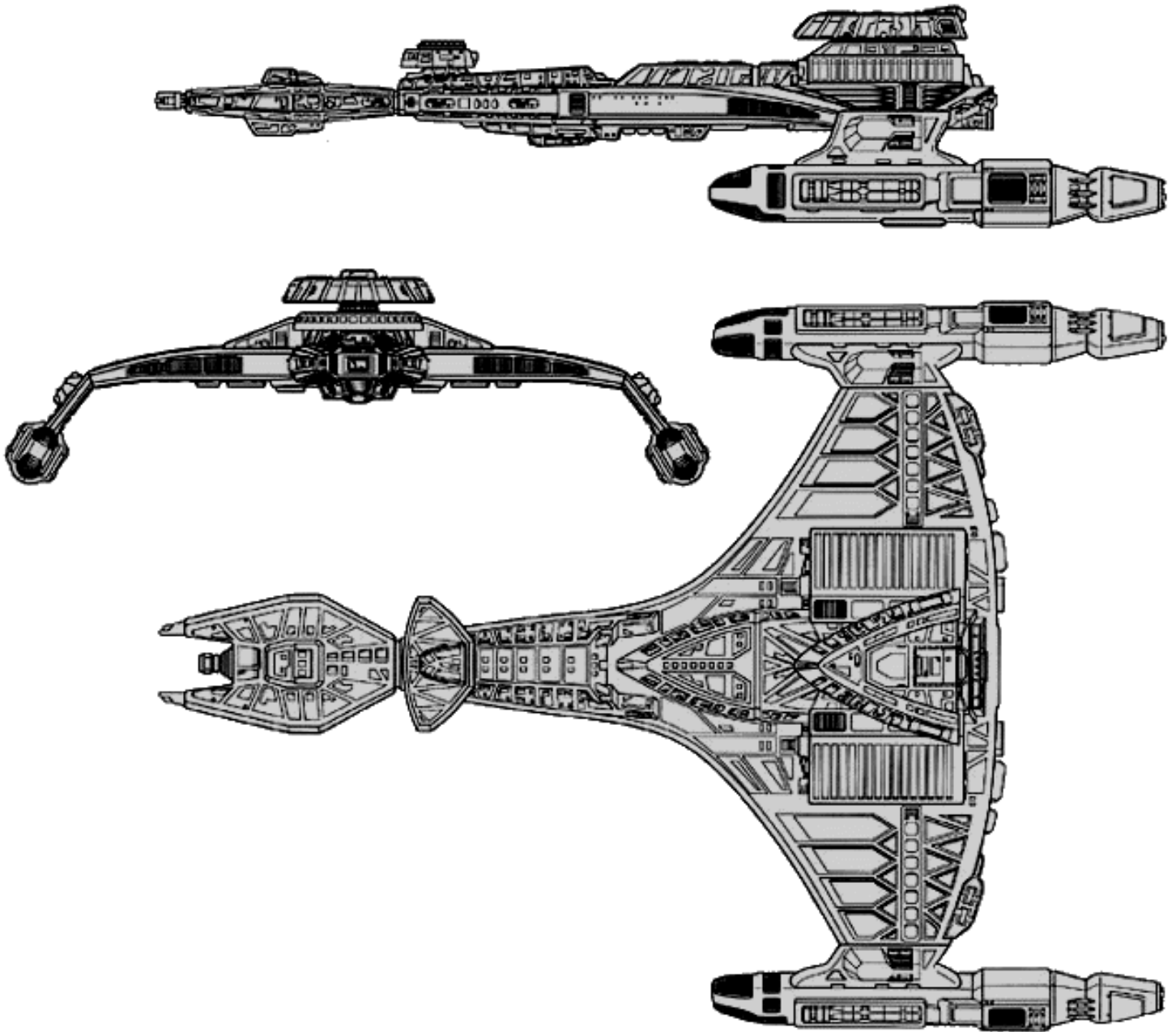

[Click here to view this ship in its own window](#)

BRAD'S COMMENTS: The Vor'cha is what the [KDF-2 K'mirra](#) should have been. At the time that FASA's TNG Officer's Manual came out, we had not yet seen the impressive Vor'cha design, and the few glimpses of TNG-era Klingon ships that had been revealed were merely redresses of the familiar [Bird Of Prey](#) and [K'tinga "D7"](#) model. Rightly reasoning that the Klingon Empire would come up with a larger ship class to match the [Ambassador](#) and [Galaxy](#) classes of their 'friends' the Federation, the OFFICERS MANUAL writers postulated the KDF-2. Even after seeing the Vor'cha on screen several times, I had to look at it very closely to convince myself that it was not actually a KDF-2! With time, though, it became obvious that the KDF-2 design had been lost to the dust bin of licensing history, but the Vor'cha class picks up where the KDF-2 leaves off, and for the sake of clarity both designs share separate and (almost) equal space on this web site

Unlike the so-called K'mirra class, the Vor'cha is actually more in tune with the way the Klingon-Federation alliance was later developed following TNG Season One. The alliance never was an easy one. Tensions were always high. The kind of technology exchange necessary to create the KDF-2, with its phaser banks and [Excelsior](#)-style engines, was never really possible. Therefor the Vor'cha looks and feels much more Klingon, from the nacelles to the command pod to the spread 'wings' of the secondary hull. A ship like this from the Kirk-era would almost certainly be classified as a battleship, but as of the advent of **ST:TNG** the Vor'cha is more of a battle cruiser. I have seen many texts labeling it as an 'attack cruiser', so I have reluctantly placed this largish fighting ship with the other Klingon cruisers in spite of its battleship-like qualities.

As always with designs that were seen in **TNG**, **DS9**, **VOY**, or other episodes and movies that come after the fall of FASA's Trek license, the stats listed below are wholly my own invention. I've tried to stick by official canon numbers where possible, and I've resisted the urge to turn this class into an out-and-out brute. But in the end it can't help but be a total brute! (I admittedly bring the Vor'cha roughly up to par with the super-brutish K'mirra because I believe the Vor'cha is what the K'mirra

Construction Data:

	Type A *	Type B *	Type C *	Type D *
Model Numbers-	XIV-XV	XIV-XV	XIV-XV	XIV-XV
Ship Class-	2344 A.D.	2354 A.D.	2359 A.D.	2368 A.D.
Date Entering Service-	155 (est)	208 (est)	85 (est)	52 (est)
Number Constructed				

Hull Data:

Superstructure Points-	76	88	110	135
Damage Chart-	C	C	C	C
Size				
Length-	457 meters	457 meters	460 meters	462 meters
Width-	240 meters	240 meters	242 meters	243 meters
Height-	100 meters	100 meters	105 meters	105 meters
Weight-	273,650 tons	281,200 tons	289,800 tons	310,350 tons
Cargo				
Cargo Units-	200 units	200 units	200 units	250 units
Cargo Capacity-	10,000 tons	10,000 tons	10,000 tons	12,500 tons
Landing Capability-	None	None	None	None

Equipment Data:

Control Computer Type-	Classified	Classified	Classified	Classified
Transporters-				
Standard 4-person-	14	14	14	14
Combat 10-person-	6	6	6	6
cargo, large-	5	5	5	5
cargo, small-	2	2	2	2
Cloaking Device Type-	KVC-X	KVC-XA	KVC-XB	KVC-XB
Power Requirement-	65	75	85	85

Other Data:

Crew-	790	785	760	755
KDF Marines-	140	140	140	140
Shuttlecraft-	6	6	6	8

Engines and Power Data:

Total Power Units Available-	100	120	140	165
Movement Point Ratio-	6/1	7/1	7/1	7/1
Warp Engine Type-	KVWE-1	KVWE-2	KVWE-2B	KVWE-3
Number-	2	2	2	2
Power Units Available-	41	50	58	65
Stress Charts-	E/F	E/F	E/F	E/F
Maximum Safe Cruising Speed-	Warp 6	Warp 7	Warp 7	Warp 8
Emergency Speed-	Warp 9.9	Warp 9.9	Warp 9.9	Warp 9.9
Impulse Engine Type-	KVI-2A	KVI-2B	KVI-4C	KVI-5
Power Units Available-	18	20	24	35

Weapons and Firing Data:

Beam Weapon Type-	KAVD-12	KAVD-12	KAVD-14	KKDT-X1 **
Number-	4	4	4	1
Firing Arcs-	2f/p, 2f/s	2f/p, 2f/s	2f/p, 2f/s	F
Firing Chart-	Y	Y	Z	Z
Maximum Power-	14	14	15	50 **
Damage Modifiers				
+3	(1 - 11)	(1 - 11)	(1 - 12)	(1 - 10)
+2	(12 - 19)	(12 - 19)	(13 - 20)	(11 - 22)
+1	(20 - 27)	(20 - 27)	(21 - 29)	(22 - 29)
Beam Weapon Type-	KAVD-13	KAVD-13	KAVD-13	KAVD-15
Number-	10	10	10	6
Firing Arcs-	4f, 2s/a, 2p/a, 2a	4f, 2s/a, 2p/a, 2a	4f, 2s/a, 2p/a, 2a	2f, 1s/a, 1p/a, 2a
Firing Chart-	T	T	T	U
Maximum Power-	9	9	9	10
Damage Modifiers				
+3	(1 - 8)	(1 - 8)	(1 - 8)	(1 - 10)

+2	(9 - 14)	(9 - 14)	(9 - 14)	(11 - 17)
+1	(15 - 20)	(15 - 20)	(15 - 20)	(18 - 24)
Missile Weapon Type-	KPT-12	KVCP-33	KVCP-33	KVCP-33
Number-	4	4	4	2
Firing Arcs-	2f, 2a	2f, 2a	2f, 2a	2a
Firing Chart-	T	T	T	T
Power To Arm-	2	3	3	3
Damage-	20	25	25	25

Shields Data:

Deflector Shield Type-	KVAS	KVAS	KVAS-B	KVAS-C
Shield Point Ratio-	1/5	1/5	1/5	2/7
Maximum Shield Power-	25	25	30	35

Defense Factor-	Classified	Classified	Classified	Classified
Weapon Damage Factor-	Classified	Classified	Classified	Classified

* Denotes completely hypothetical model number and stats, devised by Brad R. Torgersen.

** The 'main gun' on the Vor'cha is seen in action many times throughout TNG and DS9. It is capable of obliterating entire starships in a single blast! This has got to be some kind of killer weapon! It seems a little like the Romulan plasma weapons of TOS, in that it does not fire bursts or barrages. Instead, it seems to unload a single green energy bolt, almost like an energy torpedo. The KKDT-X1 weapon should be treated kind of like a mix between a torpedo and a disruptor, sans the special rules that apply to Romulan plasma weapons. The maximum power it can be energized to is a whopping 50, but it only takes half as much power to energize this weapon as a normal bank of disruptors. Therefor, pouring 10 points of energy into the KKTD-X1 will fire a bolt worth 20 points of damage. Pouring in 15 points of energy yields a bolt worth 30 points of damage, and so forth. It takes a maximum of 25 energy points to fully energize the weapon, yielding a bolt worth 50 damage points. Such a fell blow will easily vaporize small and even medium-sized warships, shields or no shields. Which seems proper to me given the fact that we see the Vor'cha do exactly this in several different episodes of TNG and DS9. It also seems reasonable to me that such a super-weapon would not have equipped the Vor'cha at its inception. Rather, this mega-weapon would only equip the latest model Vor'cha ships, perhaps as an R/D addition to combat potential Borg and especially Dominion threats.

[<<<< GO BACK](#)

IMPORTANT NOTE:

It is entirely possible that you have surfed to this page from an internet portal and are now viewing this page without frames. **The STSSTCSMU&A is best viewed from within its own set of frames**, so [click here to jump to the main STSSTCSMU&A web page](#) and then [see the site as it was meant to be seen!](#)

D-4 'PREDATOR' CLASS CRUISER

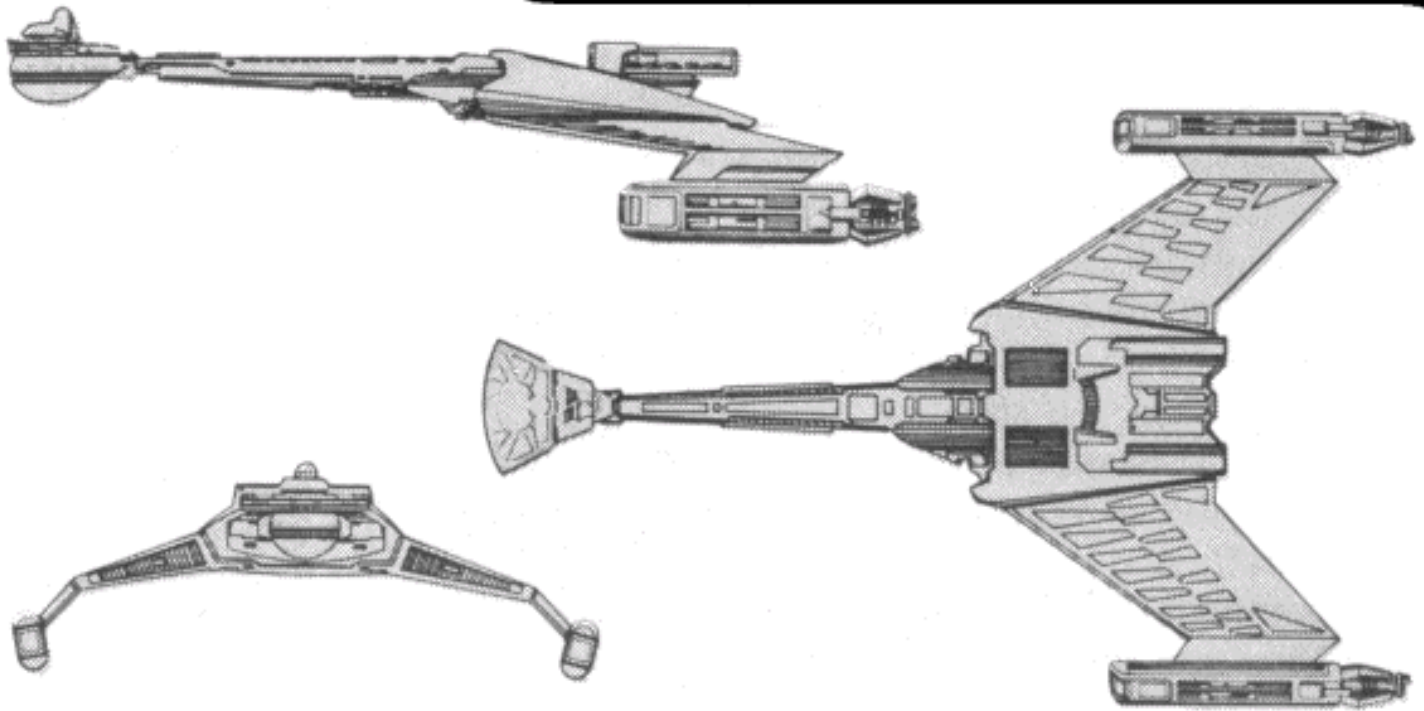

[Click here to view this ship in its own window](#)

BRAD'S COMMENTS: Even though the manual claims that the [D-7](#) was developed from the D-4, I've always thought that the [D-16 Destroyer](#) was a far more likely candidate, at least from an aesthetic perspective. Still, the D-4 and the D-7 do have a lot in common where appearances are concerned. They also share similar stats, at least when you compare the D-4's with the really early D-7's. It's too bad the game designers never gave the D-4 any torpedo technology. Armed with even a few torpedoes, the D-4 would be a nice little game piece. As it is, the D-4 is at its best when faced off against much older-style Federation and Romulan ships, like the Starfleet [Anton Class](#) or the Romulan [V-4 cruiser](#). When competing with torpedo-armed ships of similar mass, the D-4 just can't cut the mustard. Its shields collapse fast and its superstructure is easily diminished. Only when operating in pairs or trios do the D-4's have an advantage over a [Constitution Class ship](#) or a [Romulan V-27](#).

If you want to simulate a good combat situation set in the time of Christopher Pike, prior to Kirk's command of the Enterprise, I suggest setting a trio of D-4's up against a single Constitution Mark 2 hull, and seeing which player can get the better of the other. It may seem like the Klingons have numerical advantage, but the Constitution has more power, better weapons, and more superstructure.

One last thing, I've always been intrigued by the suggestion made in this ship's history that the Klingons faced an 'unknown threat' on a border opposite the Federation. The various Trek TV series never really spend much time showing us any details regarding what lies on the other sides of the Romulan and Klingon Empires. Certainly there are other civilizations and governments out there, so why don't we see or read more about them? The Cardassians, The Breen, and the Dominion, they all might count among these 'mysterious' enemies. But we're never sure.

Additional comments on the 'unknown threat' by [Russell Downey](#) - October 2002

Greetings! I was looking over your site tonight....just a quick look you understand...and after 2 hours of reading I came across your Klingon D-4 write up. The D-4 mentions an unknown enemy that the Klingons faced to their coreward boarder, and you mentioned that there was no info on who or what that was (at least that you knew at time of writing). I came across info on that particular critter in the FASA "Klingons" sourcebook for the Role Playing Game. It mentions a race called the *K'inshaya* (not sure on spelling) which is supposed to be Klingon for "demons". I no longer have that book on hand, or I would scan the info for you and send it. Anyway, the *K'inshaya* looked like a winged Wookiee/Swamp thing cross that was so tough it could withstand up to 45 minutes in hard vacuum, revive, and kick the crap out of an entire ship of Klingon warriors (well, almost, a few did survive to tell the tale :-). They also had stats for their ships in STTCS stats. They were not very impressive in looks (winged balls?) but would have been able to kick the crap out of a D-4 or [D-7A](#). A bit of useless trivia for your reading enjoyment. GREAT site, by the way, and I surely agree with many of your opinions of the ships in the FASA and Paramount Star Trek

From the FASA Star Trek KLINGON SHIP RECOGNITION MANUAL, circa 1985

D-4 (Predator) Class VII Cruiser

Known Sphere Of Operation: Interior of the Klingon Empire

Data Reliability: A

Major Data Source: Models A and E are in Star Fleet possession.

The D-4, predecessor to the famed D-7 class, pioneered the command pod forward design that has become the standard for most modern Klingon warships. The class was introduced on Stardate 1/8407 with the commissioning of eight ships, which had been produced at the alarming rate of one per month at facilities operating as if under wartime production orders. This was a clear signal that the Klingons were either preparing for a war with either Romulan or Federation forces or were involved in a conflict along an unknown border. Only recently, because of intelligence gained from Operation Dixie, has it come to light that the Klingons were in fact being attacked by an unknown enemy along their coreward border. During this conflict the D-4 saw extensive action and went through several different modifications, many of which were never brought into production. This conflict ended somewhere around Stardate 1/8610, slowing further development.

On Stardate 1/9108, the D-4E was tested and proclaimed successful. Production was converted over to this newer model, and, by Stardate 1/9203, the first vessels were commissioned. By 1/9501, the D-4A was no longer being produced, and most of the D-4A's in service were being converted to D-4E's, which mounted a more powerful impulse drive system.

The major improvement was the replacement of the KD-2 by the KD-3, with a range of 120,000 km, extending the offensive capability of the D-4 by 20,000 km. The shielding system was also upgraded, with the new KSE system giving the ship 65% more protection from incoming fire. The superstructure was strengthened to handle the uprated equipment. Even though the D-4 proved to be valuable in combat, witnessed by its class name of "Predator" from the Klingon "d'ama", its days were numbered. The D-7, with its higher firepower and more powerful engines, would replace it by Stardate 2/0806.

Of the 814 D-4's built, 277 are in reserve fleets (48 A's and 229 E's), 462 were destroyed, 14 have been captured (3 A's and 6 E's by Star Fleet and 2 A's and 3 E's by the Romulans), 6 reported as missing, 16 were scrapped, 11 sold to the Orions (4 A's and 7 E's), and 28 sold to prominent families of the Empire (10 A's and 18 E's).

Construction Data:

Model Numbers-	A	E
Ship Class-	VII	VII
Date Entering Service-	1/8407-1/9501	1/9203-0806
Number Constructed	430	384

Hull Data:

Superstructure Points-	16	17
Damage Chart-	C	C
Size		
Length-	205 meters	205 meters
Width-	130 meters	130 meters
Height-	45 meters	45 meters
Weight-	82,500 tons	84,600 tons
Cargo		
Cargo Units-	80 units	80 units
Cargo Capacity-	4,000 tons	4,000 tons
Landing Capability-	None	None

Equipment Data:

Control Computer Type-	ZD-5	ZD-5
Transporters-		
Standard 6-person-	3	3
Combat 22-person-	none	none
Emergency 18-person-	1	1
cargo-	1	1
Cloaking Device Type-	None	None
Power Requirement-	None	None

Other Data:

Crew-	295	305
Troops-	None	None
Shuttlecraft-	4	4

Engines and Power Data:

Total Power Units Available-	30	34
Movement Point Ratio-	4/1	4/1
Warp Engine Type-	KWC-1	KWC-1
Number-	2	2
Power Units Available-	14	14
Stress Charts-	L/O	L/O
Maximum Safe Cruising Speed-	Warp 7	Warp 7
Emergency Speed-	Warp 8	Warp 8
Impulse Engine Type-	KIB-2	KID-1
Power Units Available-	2	6

Weapons and Firing Data:

Beam Weapon Type-	KD-2	KD-3
Number-	5	5
Firing Arcs-	2f/p, 2f/s, 1a	2f/p, 2f/s, 1a
Firing Chart-	G	I
Maximum Power-	4	5
Damage Modifiers		
+3		
+2		
+1		

Shields Data:

Deflector Shield Type-	KSB	KSE
Shield Point Ratio-	1/1	1/1
Maximum Shield Power-	6	10

Defense Factor-	44.9	53.3
Weapon Damage Factor-	7.0	13.5

[<<<< GO BACK](#)

IMPORTANT NOTE:

It is entirely possible that you have surfed to this page from an internet portal and are now viewing this page without frames. **The STSSTCSMU&A is best viewed from within its own set of frames**, so [click here to jump to the main STSSTCSMU&A web page](#) and then [see the site as it was meant to be seen!](#)

D-16 'SWIFTWIND' CLASS DESTROYER

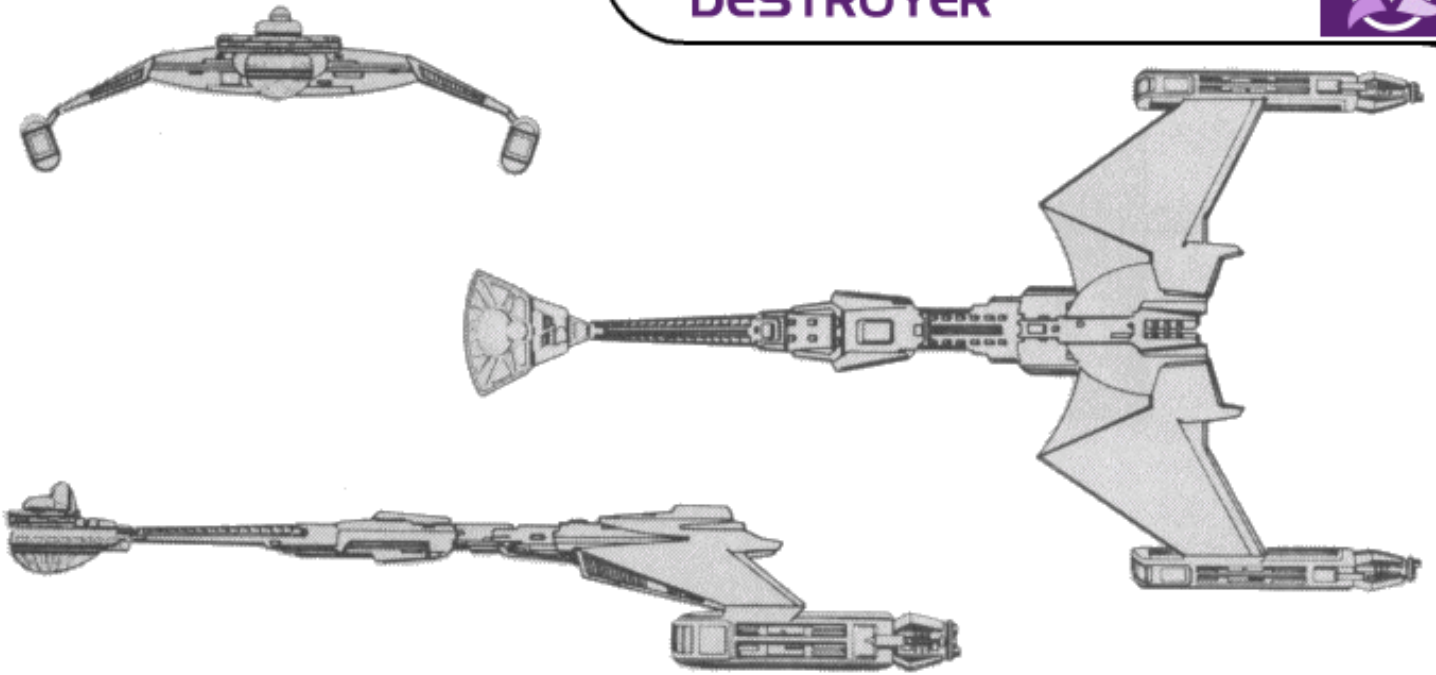

[Click here if you want to see this ship in its own window](#)

BRAD'S COMMENTS: Oh, how much nicer the old D-16 would be if it only had a stupid torpedo! Otherwise, this guy is severely undergunned compared to even the lowliest Federation escorts and destroyers. The main problem, other than lack of superstructure, is that it is underpowered. There is barely enough juice to spare for the disruptors, even after marginal power is allocated to the movement phases. The only way I have had success with this design is in large numbers tackling one relatively weak foe. Say, 6 of these ships versus a very old Federation frigate or other medium-sized vessel. In large fleet actions the D-16s tend to drop like flies.

It's a shame too because the D-16 looks great! I've often thought the D-16 looked like the great grandfather of the classic Klingon design ethic, perhaps a precursor to the famed D-7 model that we all know and love. Sometimes I wonder what logic was used in selecting which designs to go with which stats. The D-16 is a very elegant design wasted on a very poor set of stats.

From the FASA Star Trek KLINGON SHIP RECOGNITION MANUAL, circa 1985

D-16 (Swiftwind) Class VI Destroyer

Known Sphere Of Operation: Interior of Klingon Empire

Data Reliability: A

Major Data Source: In possession of Star Fleet

Of the 192 D-16s built, 27 are in reserve fleets, 123 have been destroyed, 11 have been captured (6 by Star Fleet, 4 by Romulans and 1 by Orions), 8 are listed as missing, 3 have been scrapped, 16 have been sold to ranking and prominent families in the Empire, and 4 have been sold to private interests within the Triangle. The D-16, named from the Klingon *kisarza*, was produced at Iosia.

Construction Data:

Model Numbers-	A
Ship Class-	VI
Date Entering Service-	1/1805-2/1001
Number Constructed	192

Hull Data:

Superstructure Points-	8
Damage Chart-	C
Size	
Length-	190 meters
Width-	100 meters
Height-	28 meters
Weight-	70,800 tons
Cargo	
Cargo Units-	30 units
Cargo Capacity-	1,500 tons
Landing Capability-	None

Equipment Data:

Control Computer Type-	ZD-5
Transporters-	
Standard 6-person-	2
Emergency 18-person-	1
cargo-	1
Cloaking Device Type-	None
Power Requirement-	None

Other Data:

Crew-	180
Passengers-	10
Shuttlecraft-	1

Engines and Power Data:

Total Power Units Available-	30
Movement Point Ratio-	3/1
Warp Engine Type-	KWC-1
Number-	2
Power Units Available-	14
Stress Charts-	L/O
Maximum Safe Cruising Speed-	Warp 7
Emergency Speed-	Warp 8
Impulse Engine Type-	KIB-2
Power Units Available-	2

Weapons and Firing Data:

Beam Weapon Type-	KD-4
Number-	4
Firing Arcs-	3f/p/s, 1a
Firing Chart-	G
Maximum Power-	4
Damage Modifiers	
+3	
+2	
+1	(1 - 10)
Missile Weapon Type-	None
Number-	
Firing Arcs-	
Firing Chart-	
Power To Arm-	
Damage-	

Shields Data:

Deflector Shield Type-	KSC
Shield Point Ratio-	1/1
Maximum Shield Power-	9

Defense Factor- 38.4

Weapon Damage Factor- 5.6

[<<<< GO BACK](#)

IMPORTANT NOTE:

It is entirely possible that you have surfed to this page from an internet portal and are now viewing this page without frames. **The STSSTCSMU&A is best viewed from within its own set of frames**, so [click here to jump to the main STSSTCSMU&A web page](#) and then [see the site as it was meant to be seen!](#)

D-9 'SEEKER' CLASS CRUISER

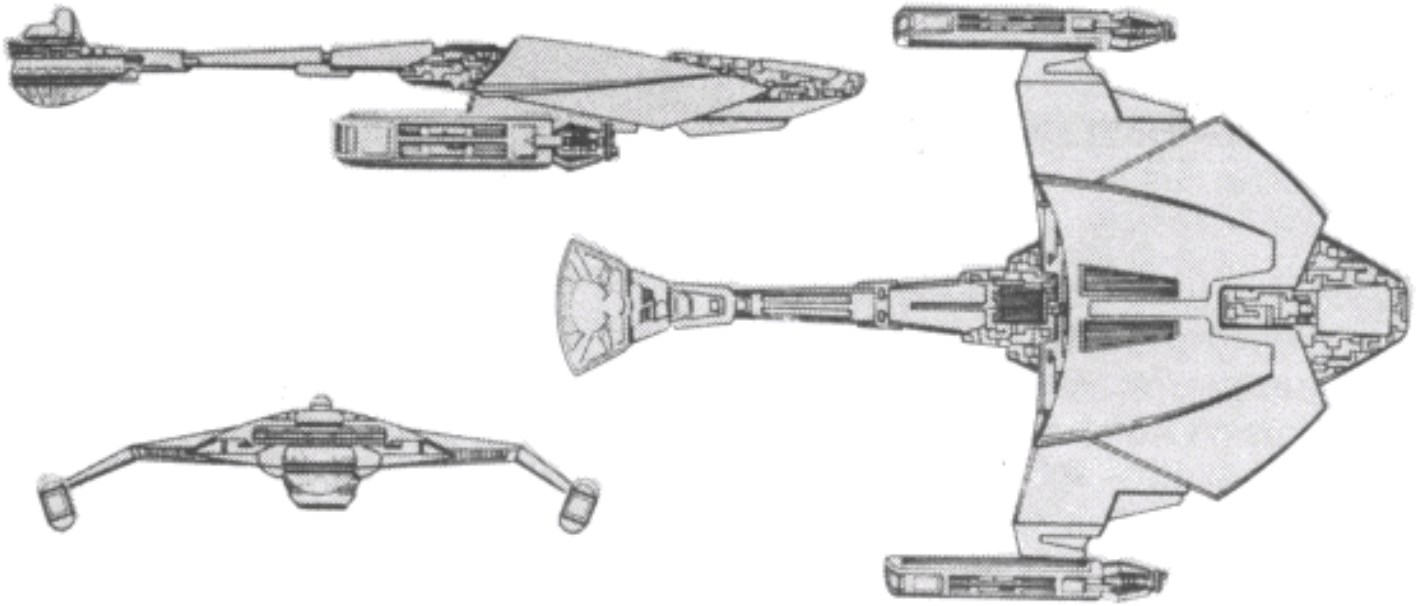

[Click here to view this ship in its own window](#)

BRAD'S COMMENTS: I always liked the D-9's looks. Small forward profile, forward-sweeping wing body, and traditional pod-on-boom back assembly. This ship looks like something from the **Star Trek II** era, not **ST:TOS** era. But the ship history suggests that it arose during the bogus "Four Years War", a time before Captain Kirk's command of the Enterprise, at least where FASA is concerned. The ship's history is also interesting in that it makes this vessel out to be a science ship. Yes, believe it or not, a Klingon science vessel. Now, that makes perfect sense from a practical standpoint. Even the rabid Klingons need to get out into the boondocks and turn over a few rocks now and again. Like the Federation, the Klingons need specialized ships to do it. Ships with combat as a secondary role. And that's just how these craft ought to be used during game play. By themselves, the D-9's are not terribly good offensive weapons. And a typical scenario should usually see these ships accompanied by escorts or even destroyers, so the D-9's can stand back from the fight and add supporting fire with their disruptors. Otherwise, close-in fighting with a torpedo-armed enemy usually spells doom for the benign D-9. I once played two D-9's and two D-4's against a Federation [Constitution Class](#) and an [Anton Class](#). That was a fairly even match. Though, I must admit the Constitution Class's torpedoes destroyed both of my D-4's and one of my D-9's before my remaining D-9 could deliver the final killing blows to the Anton and the Constitution.

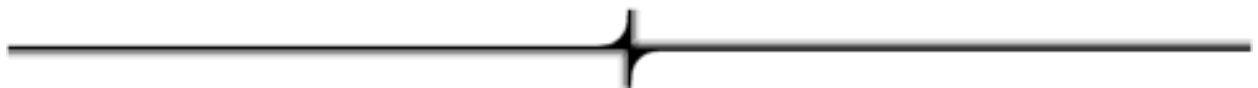

From the FASA Star Trek KLINGON SHIP RECOGNITION MANUAL, circa 1985

D-9 (Seeker) Class VIII Cruiser

Known Sphere Of Operation: Spinward and Federation Borders

Data Reliability: C

Major Data Source: Klingon Sector Intelligence

The D-9 cruiser was brought into service during the Four Years War to act as a research vessel. For years, the Klingon Empire had been halted in its attempts at expansion. To the rimward lay the Federation; towards the trailing arm were the Romulans; and it has been speculated that to the core-ward lay some unknown power able to hold the Klingons in check. This left the spinward area, as yet not fully explored. Expansion into this void had been slow due to the great distances from the homeworld of Klinzhai and the apparent lack of suitable worlds for conquest, but the desire to outflank the Federation altered that. The newly constructed D-9 cruiser was intended to lead this effort.

The D-9A prototype was considered to be undergunned and was dropped from production even before it had been commissioned. An upgunned version, the D-9B with mainly defensive weaponry, was commissioned on Stardate 1/9704 and was immediately sent into the new expansion area. These ships and their accompanying

scout ships were to map new areas and evaluate the cultural levels of any races encountered. The war with the Federation ended one year after the D-9B's entered service, and the sense of urgency for the flanking expansion effort diminished. The flanking movement is portrayed in a Star Fleet commanders test known as Operation Armageddon.

After the end of the Four Years War, most of the facilities set up to produce these research cruisers were converted over to warship designs, accounting for the small number produced. The D-9, named "Seeker" from the Klingon "z'gal", is manufactured at Gnuu Re, with production at three per year. These vessels are still operating in the spinward areas. Of the 82 D-9's built, 68 remain in active service, 9 have been destroyed, 3 are listed as missing, and 2 have been sold to private interests in the Triangle.

Construction Data:

Model Numbers-	B
Ship Class-	VIII
Date Entering Service-	1/9704
Number Constructed	82

Hull Data:

Superstructure Points-	20
Damage Chart-	C
Size	
Length-	160 meters
Width-	110 meters
Height-	24 meters
Weight-	100,500 tons
Cargo	
Cargo Units-	100 units
Cargo Capacity-	5,000 tons
Landing Capability-	None

Equipment Data:

Control Computer Type-	ZD-5
Transporters-	
Standard 6-person-	4
Combat 22-person-	none
Emergency 18-person-	2
cargo-	2
Cloaking Device Type-	None
Power Requirement-	None

Other Data:

Crew-	380
Troops-	40
Passengers-	None
Shuttlecraft-	4

Engines and Power Data:

Total Power Units Available-	38
Movement Point Ratio-	4/1
Warp Engine Type-	KWD-1
Number-	2
Power Units Available-	18
Stress Charts-	L/N
Maximum Safe Cruising Speed-	Warp 6
Emergency Speed-	Warp 8
Impulse Engine Type-	KIB-2
Power Units Available-	2

Weapons and Firing Data:

Beam Weapon Type-	KD-5
Number-	4
Firing Arcs-	1p, 2f, 1s
Firing Chart-	P
Maximum Power-	4
Damage Modifiers	
+3	
+2	(1 - 10)
+1	(11 - 18)
Beam Weapon Type-	KD-4
Number-	1
Firing Arcs-	1a
Firing Chart-	J
Maximum Power-	4
Damage Modifiers	
+3	
+2	
+1	(1 - 10)

Shields Data:

Deflector Shield Type-	KSF
Shield Point Ratio-	2/3
Maximum Shield Power-	9

Defense Factor-	61.6
Weapon Damage Factor-	14.4

[<<<< GO BACK](#)

IMPORTANT NOTE:

It is entirely possible that you have surfed to this page from an internet portal and are now viewing this page without frames. **The STSSTCSMU&A is best viewed from within its own set of frames**, so [click here to jump to the main STSSTCSMU&A web page](#) and then [see the site as it was meant to be seen!](#)

D-20 'DEATH RITE' CLASS CRUISER

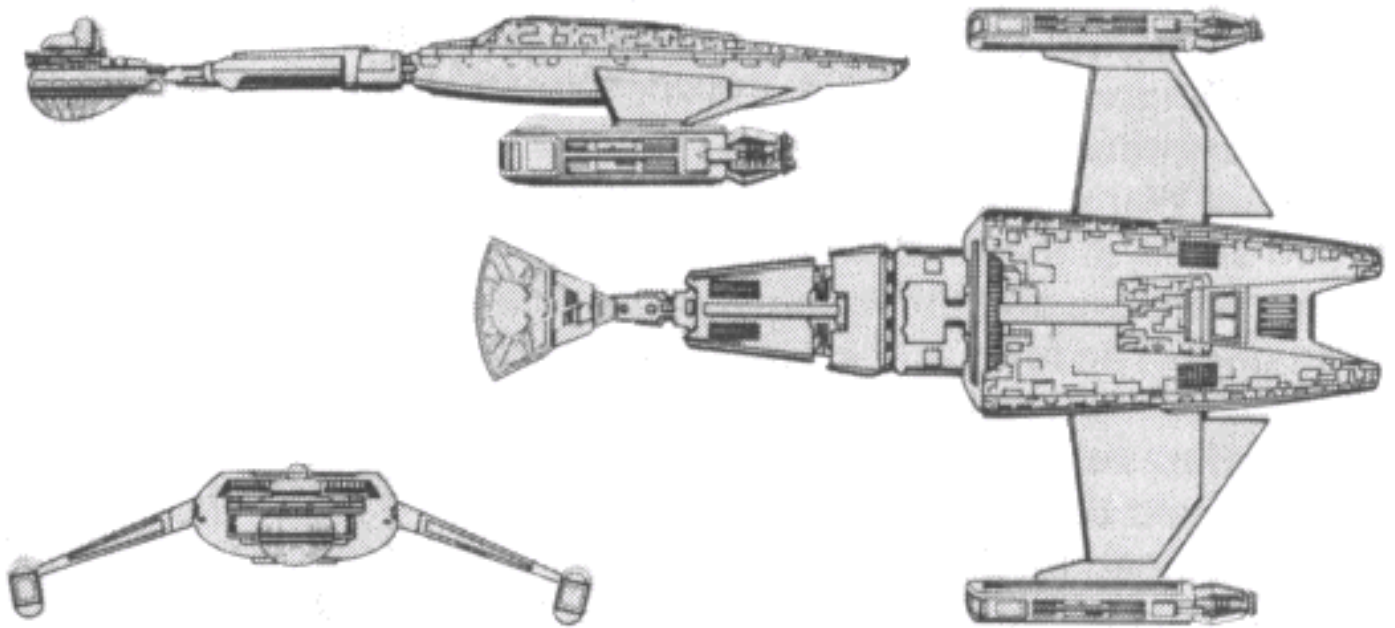

[Click here if you want to view this ship in its own window](#)

BRAD'S COMMENTS: Aesthetically, I like the looks of this ship very much. Like so many Klingon ships, it has the warp nacelles mounted on the wings, a long neck, and the traditional Klingon command pod. This ship is even featured in the cutaway color painting on the cover of the Klingon Ship Recognition Manual, which is pretty surprising considering that the [D-7 cruiser](#) is far more recognizable to fans.

In game play, the D-20 is frustrating if only because none of the three official versions mount any torpedo weaponry! Sans the power punch of torpedoes this ship is only good when used in numbers, or head-to-head against other ships also lacking torpedoes. One on one against a torpedo-armed ship, even if that ship is smaller or less powerful, the D-20 tends to lose. When I was still tinkering with the game design tables in the Ship Construction Manual I frequently liked to add torpedoes to this ship, which almost always made it dramatically more effective.

If you're going to use the D-20 in the game, I suggest placing it as part of a formation, either as an auxiliary to more powerful cruisers like the D-7 or the [D-10](#), or flanked by smaller but torpedo-armed escorts like the [D-2](#) or the [K-23D](#). In this capacity the D-20 performs okay, providing extra disruptor fire to augment the weaponry of the bigger ships or drawing attention to itself and taking blows while the smaller escorts do their thing.



From the FASA Star Trek KLINGON SHIP RECOGNITION MANUAL, circa 1985

D-20 (Death Rite) Class VII Cruiser

Known Sphere Of Operation: Empire-wide use

Data Reliability: C

Major Data Source: Klingon Sector Intelligence

The D-20 was commissioned on Stardate 1/9606 and immediately rushed into the Four Years War, where they were used much like the famed D-7. Though the class suffered from lack of maneuver power and a relatively weak superstructure, it seemed to make up for these deficiencies in its weapons, and shielding. Mounting the KWC-1 engines, the D-20A was able to attain higher warp speeds than the D-7, but was less maneuverable. Eighty-six have been converted to the D-20C.

This fault was corrected with the introduction of the D-20C on Stardate 2/1202. This model is far more

maneuverable and has more power, as well as a more efficient shielding system and stronger superstructure. Because of its extra power, KD-6 disruptors were added, increasing firepower by 50%. This model is still in production even though the D-20D has entered service on Stardate 2/1701, mounting KD-8 disruptors, which deliver 16% more destructive power over a greater distance.

Of the 634 D-20s built, 224 Cs and 80 Ds remain in active service; 292 As, 19 Cs, and 1 D have been destroyed; 2 As, 4 Cs, and 1 D are listed as missing; 1 C and 1 D have been scrapped; and 2 As, 28 Cs, and 4 Ds are in the service of ranking and prominent families of the Empire. The class is being produced at Gnuu Re' and at H'rez. These facilities were originally set up to refit A models to C models, but when orders were issued for the production of the D model, Imperial Command redesignated both bases as production facilities. They began producing new ships as soon as the last of the older models had been refit. Both facilities combined produce a total of 13 ships per year.

The class is named from "the death of honor", a traditional death rite involving a silver dagger. In this rite, a captive who has fought well is killed with a silver dagger handed down through the family lines. When a family line is broken, the dagger is destroyed after it has been used to eliminate the last family member.

Construction Data:

Model Numbers-	A	C	D
Ship Class-	VII	VII	VII
Date Entering Service-	1/9606-2/1603	2/1202	2/1701
Number Constructed	382	271	87

Hull Data:

Superstructure Points-	16	18	20
Damage Chart-	C	C	C
Size			
Length-	160 meters	160 meters	160 meters
Width-	110 meters	110 meters	110 meters
Height-	22 meters	24 meters	24 meters
Weight-	85,400 tons	91,300 tons	95,600 tons
Cargo			
Cargo Units-	200 units	200 units	200 units
Cargo Capacity-	10,000 tons	10,000 tons	10,000 tons
Landing Capability-	None	None	None

Equipment Data:

Control Computer Type-	ZD-5	ZD-6	ZD-6
Transporters-			
Standard 6-person-	3	3	3
Combat 22-person-	4	4	4
Emergency 18-person-	1	1	1
cargo-	2	2	2
Cloaking Device Type-	None	None	None
Power Requirement-	None	None	None

Other Data:

Crew-	330	340	340
Troops-	180	200	200
Shuttlecraft-	4	4	4

Engines and Power Data:

Total Power Units Available-	32	40	40
Movement Point Ratio-	4/1	3/1	3/1
Warp Engine Type-	KWC-1	KWC-2	KWC-2
Number-	2	2	2
Power Units Available-	14	18	18
Stress Charts-	L/O	L/O	L/O
Maximum Safe Cruising Speed-	Warp 7	Warp 8	Warp 8
Emergency Speed-	Warp 8	Warp 9	Warp 9
Impulse Engine Type-	KIC-2	KIC-2	KIC-2
Power Units Available-	4	4	4

Weapons and Firing Data:

Beam Weapon Type-	KD-5	KD-6	KD-8
Number-	6	6	6
Firing Arcs-	2f/p, 1f, 2f/s, 1a	2f/p, 1f, 2f/s, 1a	2f/p, 1f, 2f/s, 1a
Firing Chart-	P	T	U
Maximum Power-	4	6	7
Damage Modifiers			
+3			(1 - 7)
+2	(1 - 10)	(1 - 18)	(8 - 15)
+1	(11 - 18)		(16 - 20)

Shields Data:

Deflector Shield Type-	KSF	KSK	KSO
Shield Point Ratio-	2/3	1/2	1/2
Maximum Shield Power-	9	12	15

Defense Factor-	52.9	85.7	86.6
Weapon Damage Factor-	18.6	30.6	34.2

[<<<< GO BACK](#)

IMPORTANT NOTE:

It is entirely possible that you have surfed to this page from an internet portal and are now viewing this page without frames. **The STSSTCSMU&A is best viewed from within its own set of frames**, so [click here to jump to the main STSSTCSMU&A web page](#) and then [see the site as it was meant to be seen!](#)

D-2 'STINGTONGUE' CLASS DESTROYER

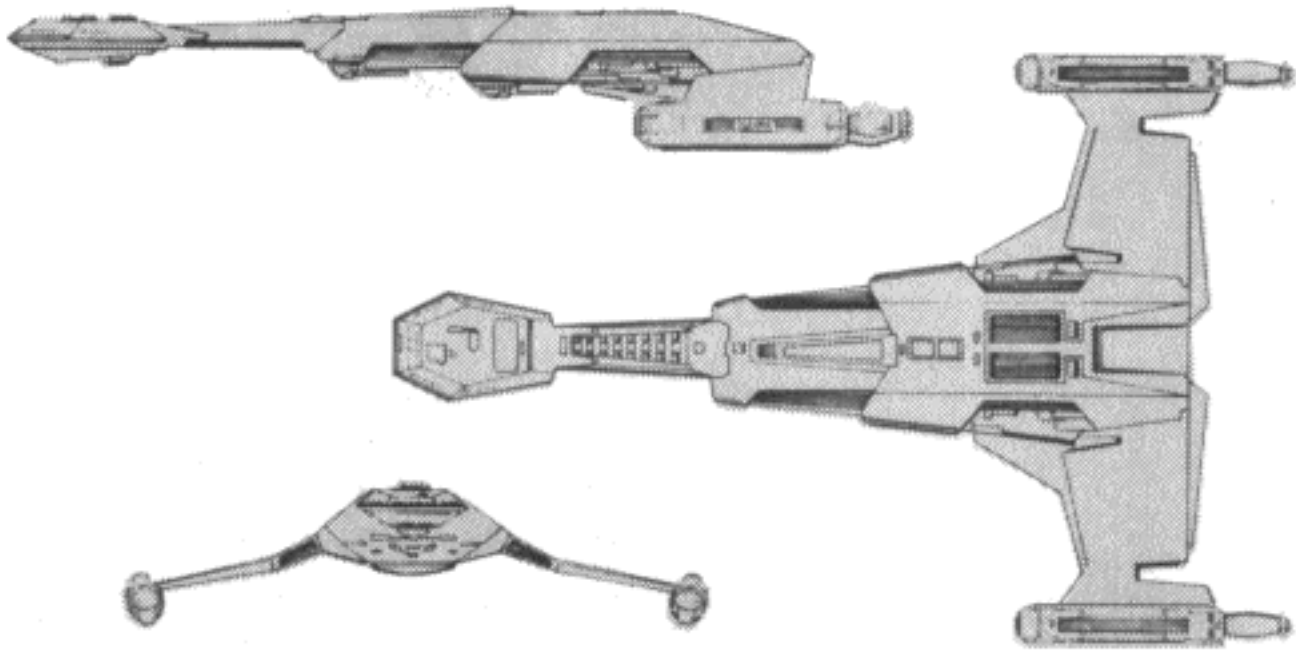

[Click here if you want to view this ship in its own window](#)

BRAD'S COMMENTS: The D-2 is an interesting ship in that it can't last long in game play with such a weak superstructure; but while it is in action it can deliver some real damage. With four torpedoes, both the A and B models can deliver the combined torpedo punch of the biggest Klingon cruisers. In my experience its best to send larger warships to engage the enemy first, and then zoom the D-2's in as a second wave, attacking with torpedoes all the way. The opponent will usually be too concerned with knocking out your bigger warships first, so you can at least hang on to the D-2's for a little while before they finally get toasted. I've had best results using multiple B models in formations of 2 or 3.



From the **FASA Star Trek KLINGON SHIP RECOGNITION MANUAL**, circa 1985

D-2 (Stingtongue) Class VI Destroyer

Known Sphere Of Operation: Empire-wide use

Data Reliability: A for D-2A, C for D-28

Major Data Source: D-2A in Star Fleet possession; Klingon Sector Intelligence

Shortly after the discovery of photon technology, the Klingon Imperial Navy initiated a program for a missile-armed destroyer. Several designs were reviewed and tested before the D-2A was commissioned on Stardate 2/1201. Five months later, the D-2B entered service, different only in the arrangement of its torpedo bays. The D-2 is an excellent offensive weapon against ships of its own class, but it is not able to hold its own against larger ships due to the lack of range its torpedoes have and a relatively weak superstructure.

These missile boats mount KWC-1 warp engines, which gives them good tactical maneuverability. Each mounts two KD-6 disruptors covering all areas of fire as well as four KP-2 photon torpedoes. The D-2A's torpedo bays are split evenly forward and aft, allowing it to close with and pass through the enemy's formation, firing torpedoes into usually unprotected aft areas. All the D-28's torpedo bays are mounted forward, giving a tremendous amount of punch from the front but none from the rear.

Of the 290 D-2s built, 128 As and 135 Bs remain in active service; 12 As and 8 Bs have been destroyed; 1 A has been captured by the Romulans; 2 As are listed as missing; 1 A has been scrapped; and 2 As are in the service of prominent families of the Empire. The D-2 class is produced at Iosia and H'renn.

Intelligence estimates these facilities produce a combined average of twelve of each type per month. The class is named from the Klingon vkarzadan, which translates to "the tongue that stings".

Construction Data:

Model Numbers-	A	B
Ship Class-	VI	VI
Date Entering Service-	2/1201	2/1206
Number Constructed	146	144

Hull Data:

Superstructure Points-	10	10
Damage Chart-	C	C
Size		
Length-	205 meters	205 meters
Width-	135 meters	135 meters
Height-	30 meters	30 meters
Weight-	74,500 tons	74,500 tons
Cargo		
Cargo Units-	30 units	30 units
Cargo Capacity-	1,500 tons	15,00 tons
Landing Capability-	None	None

Equipment Data:

Control Computer Type-	ZD-5	ZD-5
Transporters-		
Standard 6-person-	2	2
Combat 22-person-	None	None
Emergency 18-person-	2	2
cargo-	1	1
Cloaking Device Type-	None	None
Power Requirement-	None	None

Other Data:

Crew-	220	220
Passengers-	10	10
Troops-	None	None
Shuttlecraft-	1	1

Engines and Power Data:

Total Power Units Available-	34	34
Movement Point Ratio-	3/1	3/1
Warp Engine Type-	KWC-1	KWC-1
Number-	2	2
Power Units Available-	14	14
Stress Charts-	L/O	L/O
Maximum Safe Cruising Speed-	Warp 7	Warp 7
Emergency Speed-	Warp 8	Warp 8
Impulse Engine Type-	KID-1	KID-1
Power Units Available-	6	6

Weapons and Firing Data:

Beam Weapon Type-	KD-6	KD-6
Number-	2	2
Firing Arcs-	1f/p/s, 1/p/s	1f/p/s, 1/p/s
Firing Chart-	T	T
Maximum Power-	6	6
Damage Modifiers		
+3		
+2	(1 - 18)	(1 - 18)
+1		
Missile Weapon Type-	KP-2	KP-2
Number-	4	4
Firing Arcs-	2f, 2a	4f
Firing Chart-	H	H
Power To Arm-	1	1
Damage-	10	10

Shields Data:

Deflector Shield Type-	KSN	KSN
Shield Point Ratio-	2/3	2/3
Maximum Shield Power-	15	15

Defense Factor-	69.3	69.3
Weapon Damage Factor-	23.4	23.4

[<<<< GO BACK](#)

IMPORTANT NOTE:

It is entirely possible that you have surfed to this page from an internet portal and are now viewing this page without frames. **The STSSTCSMU&A is best viewed from within its own set of frames**, so [click here to jump to the main STSSTCSMU&A web page](#) and then [see the site as it was meant to be seen!](#)

K-23 'LITTLE KILLER' CLASS ESCORT

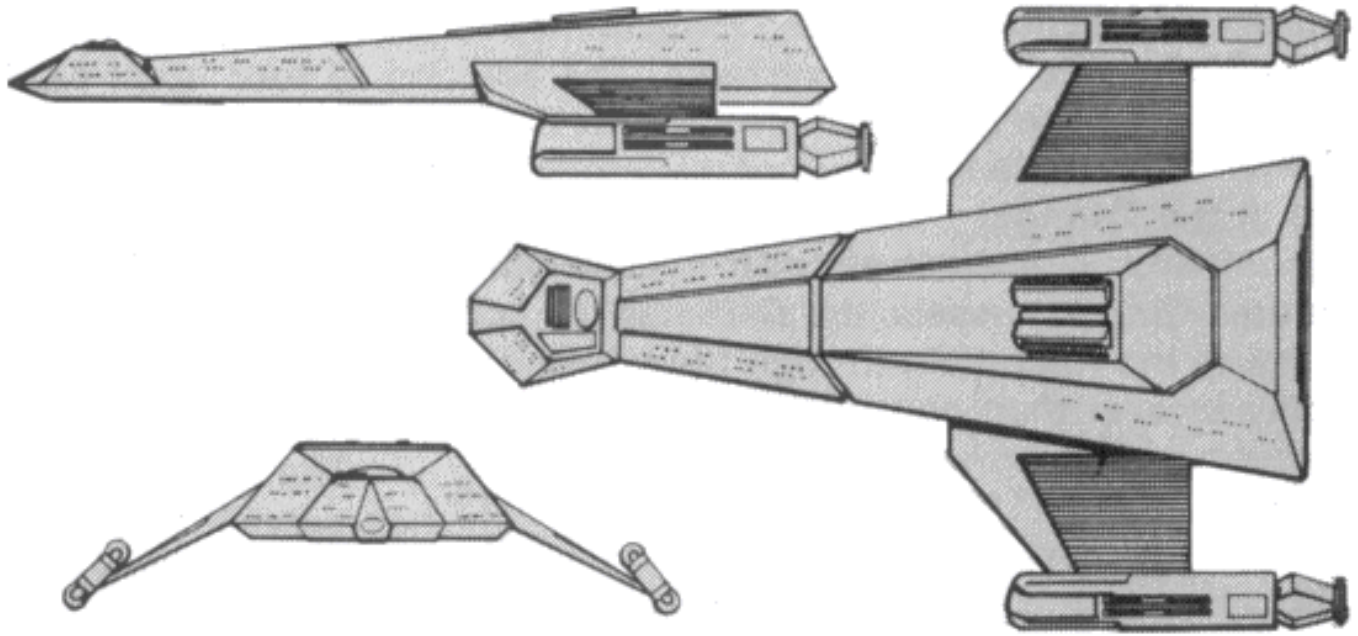

[Click here to view this ship in its own window](#)

BRAD'S COMMENTS: One of the more powerful Klingon escorts, the "Little Killer" fights like a light destroyer and has a nice balance of firepower and protection. The only thing lacking is a torpedo, but in trios these little ships can be deadly to lone cruisers and frigates. The design looks very **ST:TOS** to me, with those slab sides and all. I am fond of this ship, and have used it extensively in some combat scenarios.



From the **FASA Star Trek KLINGON SHIP RECOGNITION MANUAL**, circa 1985

K-23 (Little Killer) Class VI - VIII Escort

Known Sphere Of Operation: Empire-wide use

Data Reliability: A for K-23A, K-23B, and K-23D; C for K-23E, D for K-23F

Major Data Source: Models A, B, and D in Star Fleet possession; Klingon Sector Intelligence

As the Four Years War dragged on and the Klingon lines of supply grew longer, it became apparent to the Klingon Imperial Command that ships designed to perform escort duties were needed. This need had been foreseen when the war was in its planning stages, but the tenacity of Star Fleet was unexpected as the Klingons had never fought a protracted war. The shortage of combat vessels at the front would only permit the Klingons to detail lone destroyers as escorts, but as the raids mounted, the High Command began pulling more and more ships from the front to protect the much-needed supplies. By Stardate 1/97, the advances into Federation territory had stalled, and the K-23 was put into production to end the impasse.

When the K-23, perhaps the most deadly escort vessel in known space, was commissioned into service in 1/9702, its appearance seemed to signify an end to a Klingon tradition in ship design. Earlier designs were a blend of rounded surfaces ending in sharp lines, and the K-23 was a wedge of angular, flat surfaces with no boom or command pod, and no large main hull flying along behind.

The most notable reason for the change in design concept had to do with the war against the Federation. The first and foremost of these was the confusion factor. The Klingons decided to begin a propaganda war against the UFP, and the K-23 was to play a key role. Its angular design would not be readily identifiable as Klingon, and the confusion sowed by this uncertainty could only benefit the Klingon cause. The Klingons started rumors about having an unknown ally, and supported this propaganda by crewing the first K-23s operating in the war zone with Romulan-fusion Klingons. So complete was this ruse that the crewmembers were trained in a battle-language known only to themselves. These hand-picked crews had orders that they were never to be taken prisoners nor was their ship ever to fall into enemy hands, tactics that were to give the class its name (from the Klingon *talat khexesta*).

The decision to mount the KWC-1 warp drive system on the earliest K-23s produced was one of economics. Though the original plans for the K-23 called for the more powerful KWD-1 system, not only was the KWC cheaper

but it was being produced at the same shipyards as the K-23. This savings in time and money would cost the vessels some of their maneuverability, but, in the Klingon mind, this was a favorable trade-off for being able to produce ship's rapidly enough to continue the offensive against the Federation. Even so, the K-23A could cruise at Warp 7, fast enough for the ships to shuttle between convoys traveling at Warp 6 and provide them more protection. The early-model vessels mounted three KD-4 disruptors, each with independent fire control stations, giving them the ability to deliver a more destructive blow than most of the vessels in Star Fleet.

Of the 186 K-23As built, 129 have been converted to Bs, 54 have been destroyed, and 3 have been captured by Star Fleet. Production of the K-23A was halted shortly after the war in response to an Imperial Command order that shipyards would begin producing major components required for the vessels made at their facilities. The result of this order was the K-23B.

The KWD-1 warp drive system mounted on the K-23B delivers more power at the same efficiency rating. Though it is only capable of cruising at Warp 6, the reduction in cruising speed did not effect maneuverability. An improved shield generator also was installed, with the KSI shielding system deliver more protection.

On Stardate 2/1309, the B models were given a general recall, and, by Stardate 2/1601, the refit to the K-23D was complete on all existing vessels. Of the 332 K-23Bs built or converted, 289 have been converted to D models (72 of these were converted A models), 28 have been destroyed, 3 have been captured (2 by the Romulans and 1 by Star Fleet), 6 are listed as missing, 4 have been scrapped, and 2 have been sold to the Orions.

The K-23D was introduced on Stardate 2/1403 with the commissioning of 33 converted B models and 4 newly-built ships. The new model was given a more efficient shield generator, though it actually delivered less protection to any one area. The superstructure was strengthened, and the addition of the KD-13 disrupter increased the offensive range by 120% and the destructive power by 25%. This increase in firepower seems impressive but, in light of existing phaser technology, the K-23D is actually undergunned. With only one of its three disruptors able to fire at 220,000 km and the other two at 100,000 km, the escorts are not able to defend against larger vessels that can stand off at extreme range and deliver multiple blows. This shortcoming has been overcome by increasing the number of vessels escorting a convoy.

Of the 416 K-23Ds built, 322 remain in active service, 24 are in reserve fleets, 4 are used as training vessels, 47 have been destroyed, 5 have been captured (3 by the Romulans and 2 by Star Fleet), 6 are listed as missing, 3 have been scrapped, 2 have been traded to private interests in the Triangle, and 3 have been sold to prominent families within the Empire. Since the introduction of the vessel, the shipyards at Taamar and losia have been producing K-23Ds at an approximate rate of 14 per year.

Soon after the K-23D entered service, the K-23E was introduced with all disruptors upgraded to the KD-13, giving the ships the ability to engage their targets at extended ranges. Even with this increase in offensive range, the K-23s are still found in large groups. The escorts usually operate in flights of three, and one flight will be dispatched with every group of nine transports or freighters. During the Four YearsWar, the practice had been one escort per nine ships.

Of the 166 K-23Es built, 139 remain in active service, 19 have been destroyed, 3 are listed as missing, 1 has been traded to the Orions, and 4 are in the service of ranking families of the Empire. They are being produced at the facilities of Taamar, losia, and H'renn at an approximate rate of 20 per year.

The K-23F, never directly encountered by Star Fleet, is reported to use the KID-2 impulse drive system and to mount six KD-9 disruptors with fields of fire that include the aft sector. The new weapon arrangement is said to be easily identified by the large, ball-mounted disrupter emplacement on the underside of the bridge and amidships. The K-23F also reportedly has a strengthened superstructure and a more efficient shielding system as well. Ship data experts feel the increased abilities of the K-23 have made it a most dangerous foe.

The K-23F is rarely seen along Federation borders or in the Triangle. Of the about 100 K-23Fs thought to have been built, approximately 80 remain in active service. The disposition of the remaining vessels is unknown at the time of this printing. Intelligence data gathered by Operation Dixie suggests that these vessels are being used along the Klingon coreward borders. The entire complement of vessels constructed at H'renn and losia have been sent to this area, though it appears that only half of those produced at Taamar have been sent coreward. This would account for the limited number sighted by Star Fleet and the Romulans.

Construction Data:

Model Numbers-	A	B	D	E	F
Ship Class-	VI	VII	VII	VII	VIII
Date Entering Service-	1/9702-2/0501	2/0101-2/1601	2/1403	2/1606	2/1808
Number Constructed	186	332	461	166	101

Hull Data:

Superstructure Points-	12	12	14	14	16
Damage Chart-	C	C	C	C	C
Size					
Length-	194 meters	194 meters	194 meters	194 meters	194 meters
Width-	138 meters	138 meters	138 meters	138 meters	138 meters
Height-	38 meters	38 meters	38 meters	38 meters	38 meters
Weight-	77,250 tons	87,300 tons	90,400 tons	90,500 tons	95,800 tons
Cargo					
Cargo Units-	45 units	45 units	45 units	45 units	45 units
Cargo Capacity-	2,250 tons	2,250 tons	2,250 tons	2,250 tons	2,250 tons
Landing Capability-	None	None	None	None	None

Equipment Data:

Control Computer Type-	ZD-5	ZD-5	ZD-5	ZD-5	ZD-5
Transporters-					
Standard 6-person-	1	1	1	1	1
Combat 22-person-	none	none	none	none	none
Emergency 18-person-	none	none	none	none	none
cargo-	1	1	1	1	1
Cloaking Device Type-	None	None	None	None	None
Power Requirement-	None	None	None	None	None

Other Data:

Crew-	170	175	175	175	175
Passengers-	15	15	15	15	15
Shuttlecraft-	2	2	2	2	2

Engines and Power Data:

Total Power Units Available-	32	40	40	40	42
Movement Point Ratio-	4/1	4/1	4/1	4/1	4/1
Warp Engine Type-	KWC-2	KWD-1	KWD-1	KWD-1	KWD-1
Number-	2	2	2	2	2
Power Units Available-	14	18	18	18	18
Stress Charts-	L/O	L/N	L/N	L/N	L/N
Maximum Safe Cruising Speed-	Warp 7	Warp 6	Warp 6	Warp 6	Warp 6
Emergency Speed-	Warp 8	Warp 8	Warp 8	Warp 8	Warp 8
Impulse Engine Type-	KIC-2	KIC-2	KIC-2	KIC-2	KID-1
Power Units Available-	4	4	4	4	6

Weapons and Firing Data:

Beam Weapon Type-	KD-4	KD-4	KD-4	KD-13	KD-9
Number-	3	3	2	3	6
Firing Arcs-	1f/p, 1f, 1f/s	1f/p, 1f, 1f/s	1f/p, 1f/s	2f/p/s, 1f	2f/p/s, 2f, 2a
Firing Chart-	J	J	J	X	W
Maximum Power-	4	4	4	5	5
Damage Modifiers					
+3				(1 - 8)	(1 - 7)
+2				(9 - 15)	(8 - 15)
+1	(1 - 10)	(1 - 10)	(1 - 10)	(16 - 22)	(16 - 22)
Beam Weapon Type-			KD-13		
Number-			1		
Firing Arcs-			F		
Firing Chart-			X		
Maximum Power-			5		
Damage Modifiers					
+3			(1 - 8)		
+2			(9 - 15)		
+1			(16 - 22)		

Shields Data:

Deflector Shield Type-	KSE	KSI	KSF	KSF	KSK
Shield Point Ratio-	1/1	1/1	2/3	2/3	1/2
Maximum Shield Power-	10	12	10	10	13
Defense Factor-	39.8	48.7	56.0	56.0	71.9
Weapon Damage Factor-	6.0	6.0	9.7	17.1	30

[<<<< GO BACK](#)

IMPORTANT NOTE:

It is entirely possible that you have surfed to this page from an internet portal and are now viewing this page without frames. **The STSSTCSMU&A is best viewed from within its own set of frames**, so [click here to jump to the main STSSTCSMU&A web page](#) and then [see the site as it was meant to be seen!](#)

D-II 'ONE WING' CLASS DESTROYER

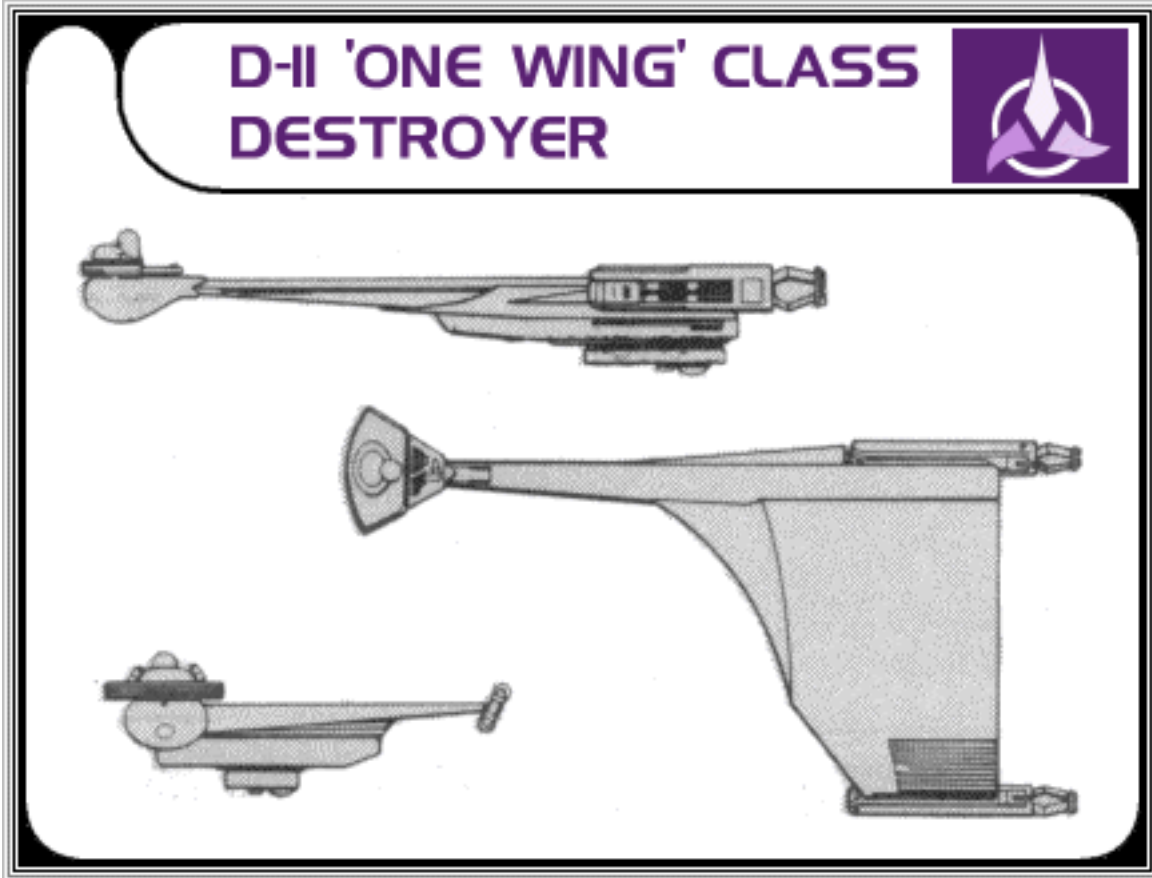

[Click here if you want to view this ship in its own window](#)

BRAD'S COMMENTS: To describe the D-11 as being both weak and ugly is being too generous. Like the [L-13](#), this ship is a major lemon! But also like the L-13, I find this ship interesting to play, precisely because it is so underwhelming. I recommend using it against similarly underpowered and undergunned ships, either singly or in pairs, thus forcing both players to win the battle on their wits, not on their brawn. Due to the lack of offensive punch, gaming sessions using this ship against similarly built foes can be a lot of fun, because they wind up playing out a lot like the battles we see in **Star Trek II**. (IE: you don't just wipe out your enemy in one or two rounds. It usually takes several rounds, if not more, of maneuvering and strategy, before you can do much damage.)



From the FASA **Star Trek KLINGON SHIP RECOGNITION MANUAL**, circa 1985

D-11 (One Wing) Class VI - VII Destroyer

Known Sphere Of Operation: Empire-wide use

Data Reliability: B

MajorDataSource: Klingon Sector Intelligence, Triangle Sector Intelligence

The D-11 destroyer is the most unusual design in the Klingon Imperial Navy, easily recognized on visual scan because of its one wing. It was commissioned into the service on Stardate 2/0405. That the vessel never fared well in battle has been blamed on its asymmetrical design, which worked to restrict the field of fire from the weapon mounting hardpoints.

Powered by the KWC-1 and able to travel at speeds of Warp 7, it was one of the fastest ships in known space at the time it was commissioned, as well as having satisfactory tactical maneuverability.

Nevertheless, the first D-11s were unpopular with the crews for they lacked sufficient firepower to perform their duties. It is not surprising then that a weaponry modification was made in the D-11C, in which the KD-4s were replaced with KD-5s and the new KD-10 was added. Although this extended the offensive range by 80,000 km, the D-11's performance in battle was not significantly improved.

The D-11D used the KWC-2 warp engine, increasing the warp speeds attainable. It also mounted the new photon torpedo, which gave it more destructive firepower in a limited range but did little to improve battle performance overall.

Due to its problems and the success of other destroyer designs, the mission of the D-11 has been changed. These vessels are now used for light assault duties. Having the capacity to carry a company of

marines, the D-11s are used to secure lightly-held systems. They also have been reported to be accompanying the D-9 research cruisers in their efforts to open new territories.

Of the 354 D-11s built, 106 Cs and 41 Ds remain in active service; 68 Bs, 39 Cs and 18 Ds have been destroyed; 1 D has been captured by the Romulans; 11 Bs and 2 Cs are listed as missing; 19 Bs and 4 Cs have been scrapped; 6 Bs, 2 Cs, and 2 Ds have been sold to the Orions; and 12 As have been sold to private interests in the Triangle. The D-11 is no longer under production; it was manufactured at Taamar and H'renn.

The class name of 'One Wing' and its nickname of "The One-Armed Bandit" derive obviously from its design, as well as from the Klingon dath d'Ian. Many jokes circulate through Star Fleet concerning the design. The most long-lived of these has it that the designer was under pressure to have the design completed by a certain date. In order to satisfy his contract and spare his life, goes the story, the manufacturer completed the ship minus the starboard wing assembly.

Construction Data:

Model Numbers-	B	C	D
Ship Class-	VI	X	X
Date Entering Service-	2/0405-2/1804	2/0811	2/1201
Number Constructed	140	153	61

Hull Data:

Superstructure Points-	14	14	15
Damage Chart-	C	C	C
Size			
Length-	234 meters	234 meters	234 meters
Width-	128 meters	128 meters	128 meters
Height-	34 meters	32 meters	45 meters
Weight-	79,900 tons	80,500 tons	85,500 tons
Cargo			
Cargo Units-	120 units	120 units	120 units
Cargo Capacity-	6,000 tons	6,000 tons	6,000 tons
Landing Capability-	None	None	None

Equipment Data:

Control Computer Type-	ZD-5	ZD-5	ZD-6
Transporters-			
Standard 6-person-	2	2	2
Combat 22-person-	2	2	2
Emergency 18-person-	2	2	2
cargo-	1	1	1
Cloaking Device Type-	None	None	None
Power Requirement-	None	None	None

Other Data:

Crew-	218	218	225
Troops-	220	220	220
Shuttlecraft-	2	2	3

Engines and Power Data:

Total Power Units Available-	32	32	40
Movement Point Ratio-	3/1	3/1	3/1
Warp Engine Type-	KWC-1	KWC-1	KWC-2
Number-	2	2	2
Power Units Available-	14	14	18
Stress Charts-	L/O	L/O	L/O
Maximum Safe Cruising Speed-	Warp 7	Warp 7	Warp 8
Emergency Speed-	Warp 8	Warp 8	Warp 9
Impulse Engine Type-	KIC-2	KIC-2	KIC-1
Power Units Available-	4	4	4

Weapons and Firing Data:

Beam Weapon Type-	KD-4	KD-5	KD-9
Number-	2	2	2
Firing Arcs-	1f/p, 1a/s	1f/p, 1a/s	1f/p, 1a/s
Firing Chart-	J	P	W
Maximum Power-	4	4	5
Damage Modifiers			
+3			(1 - 7)
+2		(1 - 10)	(8 - 15)
+1	(1 - 10)	(11 - 18)	(16 - 20)
Beam Weapon Type-		KD-10	KD-11
Number-		1	1
Firing Arcs-		F	F
Firing Chart-		C	F
Maximum Power-		3	5
Damage Modifiers			
+3			
+2			(1 - 4)
+1		(1 - 6)	(5 - 8)
Missile Weapon Type-			KP-1
Number-			2
Firing Arcs-			1f, 1a
Firing Chart-			F
Power To Arm-			1
Damage-			6

Shields Data:

Deflector Shield Type-	KSJ	KSJ	KSJ
Shield Point Ratio-	2/3	2/3	2/3
Maximum Shield Power-	13	13	13

Defense Factor-	60.9	60.9	68.5
Weapon Damage Factor-	4	6.9	13.2

[<<<< GO BACK](#)

IMPORTANT NOTE:

It is entirely possible that you have surfed to this page from an internet portal and are now viewing this page without frames. **The STSSTCSMU&A is best viewed from within its own set of frames**, so [click here to jump to the main STSSTCSMU&A web page](#) and then [see the site as it was meant to be seen!](#)

D-14 'STINGER' CLASS DESTROYER

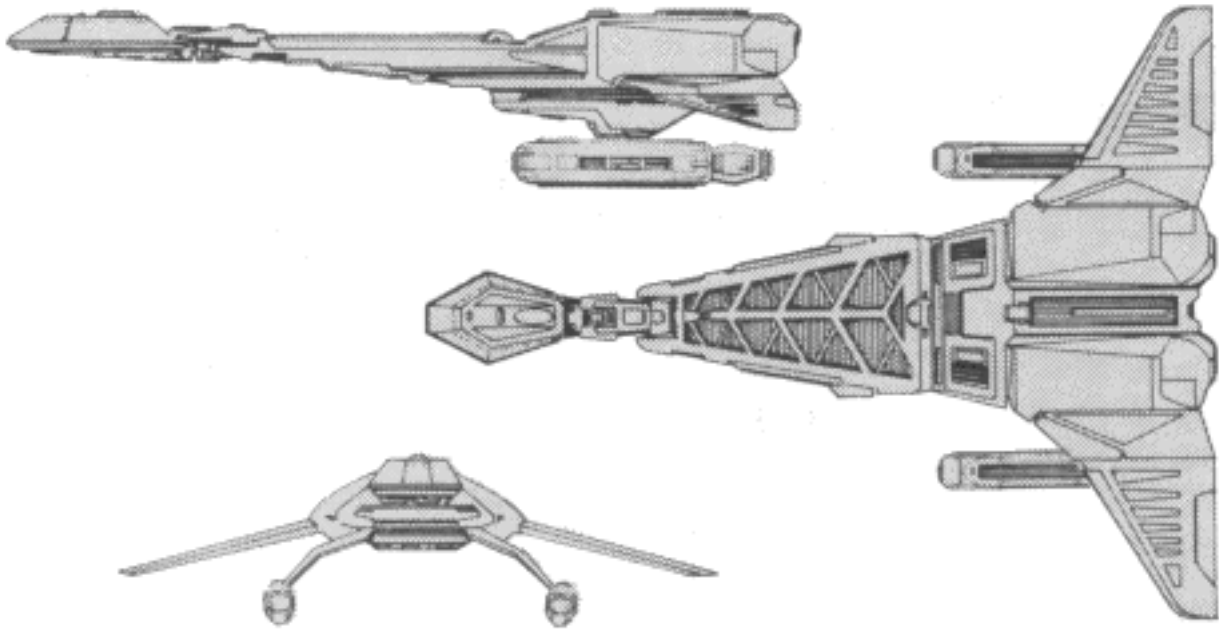

[Click here if you would like to view this ship in its own window](#)

BRAD'S COMMENTS: The D-14 is a pretty decent Destroyer by Klingon standards, and I have used it a lot in scenarios over the years. It has a decent amount of power, torpedoes, and the B model even has a cloaking device for sneak attacks. The aesthetics of the D-14 please me as well. I have always liked the extended wings over the dropped-down nacelles. It looks a little like a swooping bird. Although, with wings, shouldn't this craft be atmospheric capable? A goof on the part of FASA perhaps?



From the FASA Star Trek KLINGON SHIP RECOGNITION MANUAL, circa 1985

D-14 (Stinger) Class VI Destroyer

Known Sphere Of Operation: Federation and Triangle Borders

Data Reliability: C

Major Data Source: Triangle Sector Intelligence

Two models of this destroyer have been produced. Twelve D-14Bs are equipped with the KCB cloaking device. The class name, from the Klingon *desta kar*, refers to a predator on the planet Nogunda; this creature immobilizes its prey by injecting a paralyzing agent through its stinger. Of the 208 D-14s built, 119 As and 61 Bs remain in active service; 20 As and 1 B have been destroyed; 2 As and 1 B have been listed as missing; and 1 B has been traded to the Romulans, 1 A has been sold to the Orions, and 2 Bs have been sold to private interests in the Triangle. The D-14 is under production at Taamar, H'renn, and Fonawl. The combined annual rate is 20 of each type.

Construction Data:

Model Numbers-	A	B
Ship Class-	VI	VI
Date Entering Service-	2/1607	2/2808
Number Constructed	142	66

Hull Data:

Superstructure Points-	15	15
Damage Chart-	C	C
Size		
Length-	220 meters	220 meters
Width-	170 meters	170 meters
Height-	42 meters	42 meters
Weight-	59,800 tons	60,100 tons
Cargo		
Cargo Units-	80 units	80 units
Cargo Capacity-	4,000 tons	4,000 tons
Landing Capability-	None	None

Equipment Data:

Control Computer Type-	ZD-5	ZD-5
Transporters-		
Standard 6-person-	2	3
Emergency 18-person-	2	2
cargo-	1	1
Cloaking Device Type-	None	KCB
Power Requirement-	None	22

Other Data:

Crew-	285	292
Passengers-	30	30
Shuttlecraft-	2	2

Engines and Power Data:

Total Power Units Available-	40	40
Movement Point Ratio-	3/1	3/1
Warp Engine Type-	KWC-3	KWC-3
Number-	1	1
Power Units Available-	22	22
Stress Charts-	L/M	L/M
Maximum Safe Cruising Speed-	Warp 6	Warp 6
Emergency Speed-	Warp 7	Warp 7
Impulse Engine Type-	KIE-3	KIE-3
Power Units Available-	18	18

Weapons and Firing Data:

Beam Weapon Type-	KD-6	KD-6
Number-	4	4
Firing Arcs-	1p/a, 2f/ps, 1s/a	1p/a, 2f/ps, 1s/a
Firing Chart-	T	T
Maximum Power-	6	6
Damage Modifiers		
+3		
+2	(1 - 18)	(1 - 18)
+1		
Missile Weapon Type-	KP-1	KP-2
Number-	2	2
Firing Arcs-	1f, 1a	1f, 1a
Firing Chart-	F	H
Power To Arm-	1	1
Damage-	6	10

Shields Data:

Deflector Shield Type-	KSG	KSG
Shield Point Ratio-	1/2	1/2
Maximum Shield Power-	11	11
Defense Factor-	74.5	74.5
Weapon Damage Factor-	23.4	27.0

[<<<< GO BACK](#)

IMPORTANT NOTE:

It is entirely possible that you have surfed to this page from an internet portal and are now viewing this page without frames. **The STSSTCSMU&A is best viewed from within its own set of frames**, so [click here to jump to the main STSSTCSMU&A web page](#) and then [see the site as it was meant to be seen!](#)

D-18 'GULL' CLASS DESTROYER

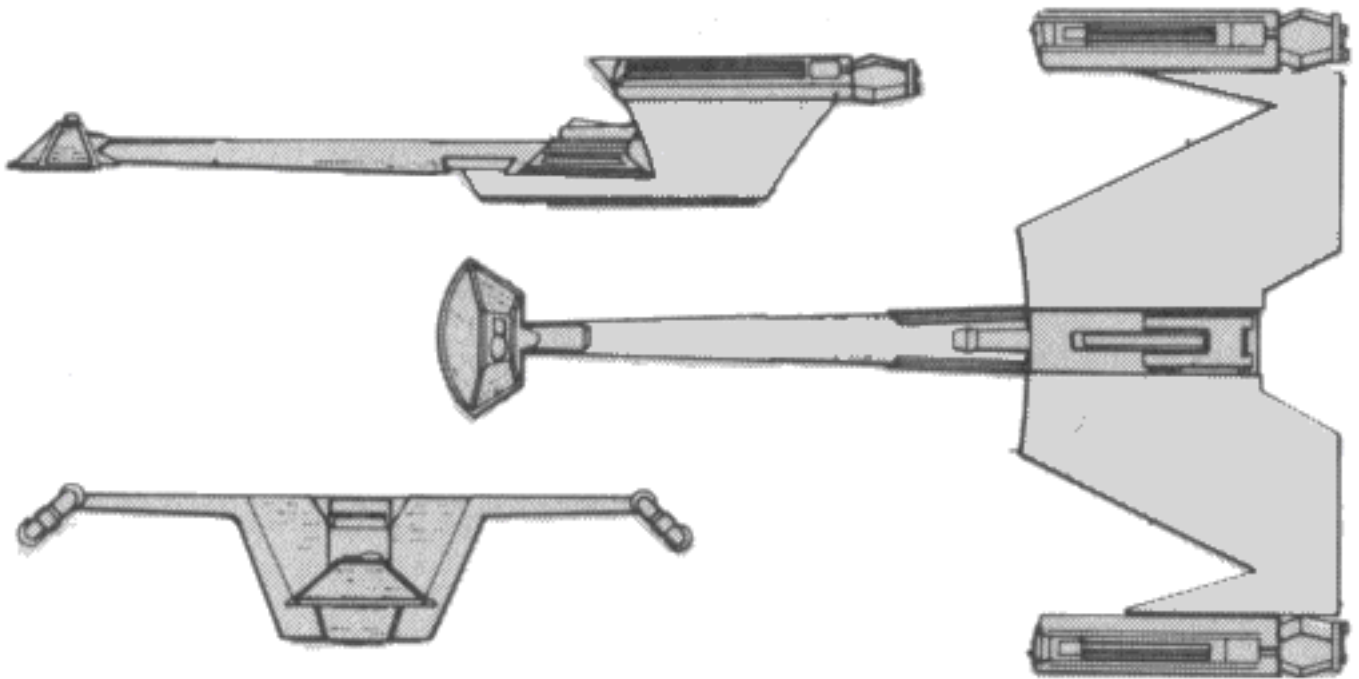

[Click here if you want to view this ship in its own window](#)

BRAD'S COMMENTS: A very capable destroyer, with some good old fashioned **ST:TOS** lines. The D-18C is particularly fun to play because of the cloaking capability, but even the D-18B is well matched against similar destroyers from other Trek governments. This is one of the Klingon destroyer designs that was given a considerable amount of backstory by the FASA writers, and some of it is funny to read given almost two decades of Trek progress since the original manuals came out in the early to mid 1980's. There's that mythic Triangle again, a place located on no canon star map and never mentioned in any episode script, so far as I know. Ditto for the Klingonese place names and the name of the captain, *Krezs sutai Kargon*. Would that be Kresz of the House of Kargon, or Kargon of the House of Kresz? It's obvious that in 1985 so much of the Klingon universe had yet to be fleshed out. Had the backstory for this ship been written today, doubtless it would have been written very differently.



From the FASA Star Trek KLINGON SHIP RECOGNITION MANUAL, circa 1985

D-18 (Gull) Class VII - IX Destroyer

Known Sphere Of Operation: Empire-wide use

Data Reliability: A for D-18A and D-18B; C for D-18C

Major DataSource: A and B models in Star Fleet possession; Klingon Sector Intelligence

The D-18, by far the most widely-used destroyer in the Klingon Imperial Navy, is found in every region of Klingon space and in the Triangle. There are even reports of D-18 groups accompanying research efforts in the spinward areas.

Like other Klingon vessels, the D-18 has the command pod forward of the main hull, though the boom or neck is considerably smaller than on other designs. The thin neck has no storage compartments or uses other than to contain a horizontal turbolift. The pod has jettison mechanism coupled with a small impulse drive system, but, unlike other self-contained pods, it contains no weapons. All the bridge crew quarters are located in the pod, as are food synthesizers and life-support systems.

The main hull of the D-18 is very large and spacious, featuring the very effective compartmented design to reduce decompressive explosion in case of penetration. The warp drives are mounted at the outer

edge of the wings, giving the ship a gull-wing appearance and its nickname. The warp engines may be jettisoned in case of an overload, leaving the hull to operate with its impulse drive system located center-aft. Inside the hull, forward of the impulse drive, is the engineering section for the entire ship, occupying a roomy eight decks. Forward of engineering, in the center-forward area of the main hull just above the connecting point for the boom, is the impressive shuttle bay, containing space for twelve shuttlecraft, more than most major warships. The beam weapons are mounted on the underside of the main hull, with the forward-firing KD-5s at the corners and center of the hull and the aft-firing KD-14 centrally mounted; in later models, the KD-14 is mounted on the bottom of the torpedo bay.

The D-18B and later models have command pods with an angular appearance and no weaponry. In addition, the D-18B mounts the highly efficient KWE-3 warp drive system, giving cruising speeds of Warp 8 and emergency speeds of Warp 9, making the D-18B one of the fastest ships in known space, and providing more maneuverability and more power to the weapons systems. The addition of four more KD-5 disruptors gives this model the firepower lacking in the D18A. The only drawback of this model is that when the additional engine mass was added, the effectiveness of the shield generators decreased.

The D-18B, the most common model to be encountered, has served the Klingon Imperial Navy well and has been involved in many encounters both with the Federation and Romulans. The most notable of these is 'The Kargon Incident'. In this skirmish, Captain Kresz sutai Kargon, commanding a group of six D-18Bs, attacked a Federation outpost located in the Orion sector. Responding to the outpost's distress call was the *USS Kongo* (a Constitution class cruiser) accompanied by the *USS Halk* and *USS Rome* (both Loknar class frigates). The Federation ships arrived too late to save the outpost, but not too late to engage the Klingons. Detecting only three ships on sensors, one with severe damage and the others with minor damage, Captain J.C. Fredriksen of the *Kongo* ordered the Loknars to close with the Klingons and demand their surrender.

In the meantime, the *Kongo* approached the D-18 lying dead in space. As the *Kongo* neared the vessel, sensors picked up three ships coming out of warp to the rear and the systems aboard the dead ship coming to life. Captain Fredriksen ordered the helmsman to turn hard about, but it was too late. The damaged D-18 destructed with such tremendous force that the *Kongo's* starboard warp nacelle was ripped from the hull and the port engine damaged beyond repair. The incoming D-18s fired into the burning wreck of the *Kongo* and completed the deed their comrades had begun. The *Halk* was so taken by surprise that it, too, never had a chance to return fire, and the first volley of shots from the oncoming D-18s totally destroyed the frigate. The *Rome*, however, opened fire on one of the disabled D-18s and scored two photon torpedo hits on its bridge and numerous phaser hits to its engines. The *Rome* then turned on the other disabled D-18 and began firing as fast as it could, scoring hits with every shot. The D-18s rushing in from their attack on the *Halk* fired in unison, and the *Rome*, though it had fought valiantly, suffered the same fate as the other two Star Fleet vessels. News of this attack reached Star Fleet three days later when a communications marker from the *Rome* was retrieved. From this report, it was also learned that the Klingon ships in this engagement were painted in bright blue colors. Ships of this description have been seen in and near the Triangle. Whether they are the ships of Captain Kresz sutai Kargon is unknown.

Of the 358 D-18Bs built, 257 remain in active service, 2 are used as training vessels, 82 have been destroyed, 9 have been captured (5 by Star Fleet and 4 by the Romulans), 4 are listed as missing, 1 has been scrapped, and 3 are in the service of ranking families in the Empire. The D-18B is currently being produced at the construction facilities located at H'renn and losia. These facilities have an average production rate of 20 ships per year.

The D-18C has an aft-firing photon torpedo, added to cover the weak spot of the ship. It also mounts a KSD shield generator, which has a binary transformer that produces shielding at twice the level of efficiency as the KSE system found on the D-188. Of the 82 D-18Cs built, 75 remain in active service, 4 have been destroyed, 1 is listed as missing, and 2 have been sold to private interests in the Triangle. The D-18C is currently being produced at Taamar, Fonawl, and Mustaka. Information received from Operation Dixie indicates that these facilities have a combined production rate of 18 per year.

The Klingons call the class *Laraatan*, which translates to 'protector of brothers'. The class is more commonly referred to as 'Gull' by Star Fleet personnel, an obvious reference to its appearance.

When the D-18A entered service on Stardate 2/0108, the military situation along all borders was relatively calm. The Klingons, still recovering from the war with the Federation, did not wish to antagonize Star Fleet any more than necessary, so the first groups of D-18As were placed along the Romulan and Triangle borders. For three years, the D-18As performed patrol duties without incident.

In the ship's first combat test, three D-18s were ordered into the Triangle to intercept a Romulan convoy and destroy the transports. Intelligence reports had shown that there would be an escort of only one ship, a new R-4 about which nothing was known. The D-18s approached the convoy from three different

directions, hoping to catch the escort with flanking fire and dispatch it easily. The R-4 was not alone, however, but was accompanied by another R-4. The Klingons began firing as soon as they were in range. In response, the Romulans concentrated all fire on first one of the D-18s and then another, doing heavy damage. The Klingon captains realized that their ships were underpowered and undergunned for this type of mission, and began a fighting withdrawal; one survived.

This engagement showed the Imperial Command that the D-18 needed more efficient engines and a better array of weapons. As originally designed, the pod on the D-18A did carry beam weapons, but, by Stardate 2/1512, all of the old A models had been converted to Bs.

Of the 231 D-18As built, 156 have been converted to Bs, 62 have been destroyed, 4 (3 by the Romulans and 1 by Star Fleet) have been captured, 2 are listed as missing, 3 have been scrapped, and 3 have been sold to private interests in the Triangle.

Construction Data:

Model Numbers-	A	B	C
Ship Class-	VII	IX	IX
Date Entering Service-	2/0108-2/1512	2/1110	2/1803
Number Constructed	231	358	82

Hull Data:

Superstructure Points-	14	14	14
Damage Chart-	C	C	C
Size			
Length-	215 meters	212 meters	212 meters
Width-	159 meters	159 meters	159 meters
Height-	38 meters	38 meters	38 meters
Weight-	90,500 tons	125,500 tons	125,800 tons
Cargo			
Cargo Units-	65 units	70 units	70 units
Cargo Capacity-	3,250 tons	3,500 tons	3,500 tons
Landing Capability-	None	None	None

Equipment Data:

Control Computer Type-	ZD-5	ZD-6	ZD-6
Transporters-			
Standard 6-person-	2	2	2
Emergency 18-person-	2	2	2
cargo-	1	1	1
Cloaking Device Type-	None	None	KCC
Power Requirement-	None	None	32

Other Data:

Crew-	265	265	280
Troops-	20	20	20
Shuttlecraft-	12	12	12

Engines and Power Data:

Total Power Units Available-	38	42	42
Movement Point Ratio-	4/1	3/1	3/1
Warp Engine Type-	KWD-1	KWE-3	KWE-3
Number-	2	2	2
Power Units Available-	18	20	20
Stress Charts-	L/N	J/M	J/M
Maximum Safe Cruising Speed-	Warp 6	Warp 8	Warp 8
Emergency Speed-	Warp 8	Warp 9	Warp 9
Impulse Engine Type-	KIB-2	KIB-2	KIB-2
Power Units Available-	2	2	2

Weapons and Firing Data:

Beam Weapon Type-	KD-5	KD-5	KD-5
Number-	2	6	6
Firing Arcs-	1f/p, 1f/s	2f/p, 2f, 2f/s	2f/p, 2f, 2f/s
Firing Chart-	P	P	P
Maximum Power-	4	4	4
Damage Modifiers			
+3			
+2	(1 - 10)	(1 - 10)	(1 - 10)
+1	(11 - 18)	(11 - 18)	(11 - 18)
Beam Weapon Type-	KD-14	KD-14	KD-14
Number-	1	1	1
Firing Arcs-	A	A	A
Firing Chart-	D	D	D
Maximum Power-	8	8	8
Damage Modifiers			
+3			
+2	(1 - 6)	(1 - 6)	(1 - 6)
+1			
Missile Weapon Type-			KP-5
Number-			1
Firing Arcs-			A
Firing Chart-			Q
Power To Arm-			1
Damage-			10

Shields Data:

Deflector Shield Type-	KSE	KSE	KSD
Shield Point Ratio-	1/1	1/1	1/2
Maximum Shield Power-	10	10	8

Defense Factor-	47.5	54.0	71.0
Weapon Damage Factor-	8.3	20.7	26.2

[<<<< GO BACK](#)

IMPORTANT NOTE:

It is entirely possible that you have surfed to this page from an internet portal and are now viewing this page without frames. **The STSSTCSMU&A is best viewed from within its own set of frames**, so [click here to jump to the main STSSTCSMU&A web page](#) and then [see the site as it was meant to be seen!](#)

K-24 'WINNER' CLASS ESCORT

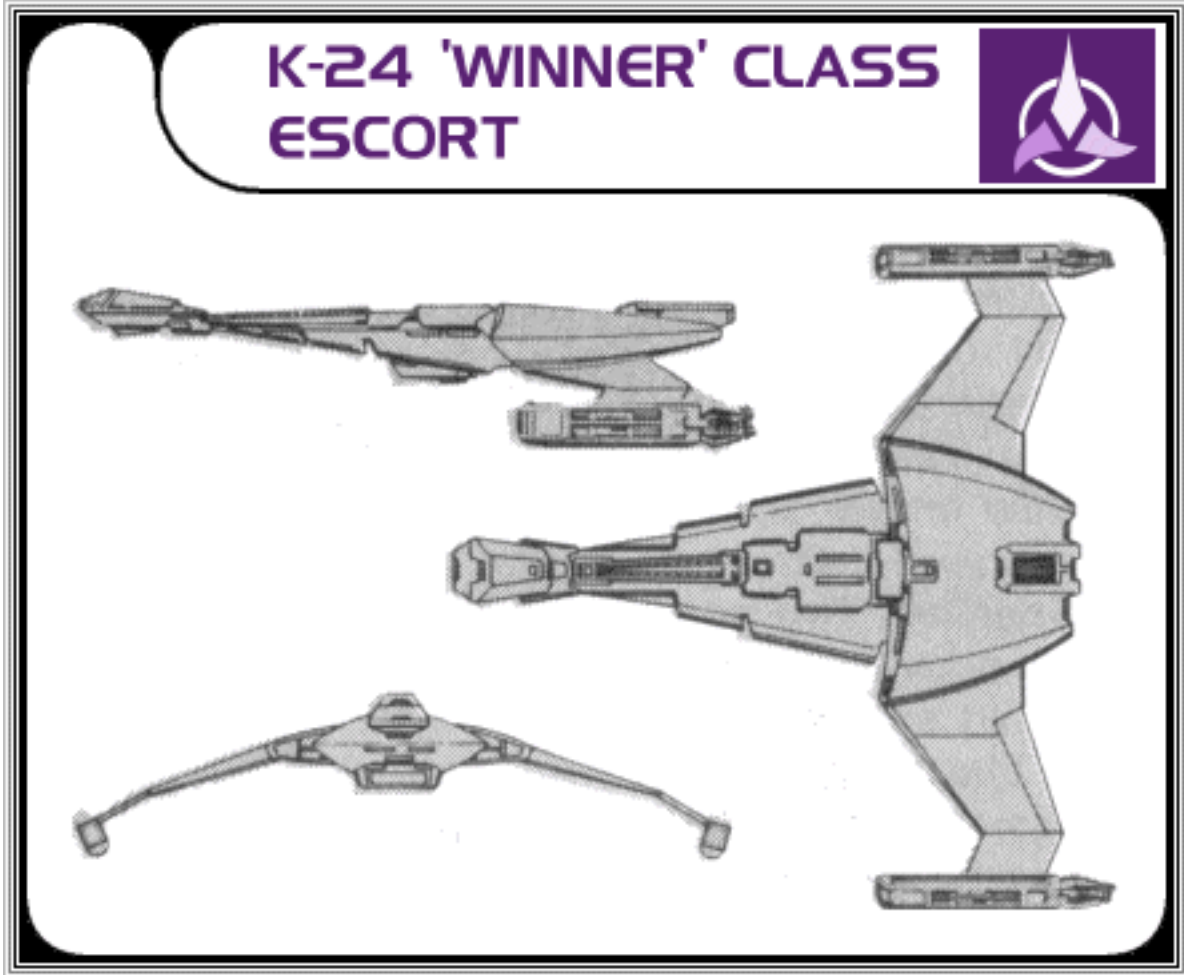

[Click here to view this class in its own window](#)

BRAD'S COMMENTS: Not a bad little escort, it has powerful shields for its size. As with the K-23 this class would probably be twice as good if it mounted even a single torpedo of some kind. Trying to maneuver and fire disruptors forces any gamer to be mighty choosy about where his or her power is allocated to. Aesthetically the K-24 has always been a bit unremarkable to me; like its performance during play.



From the FASA Star Trek KLINGON SHIP RECOGNITION MANUAL, circa 1985

K-24 (Winner) Class VII Escort

Known Sphere Of Operation: Coreward and spinward areas

Data Reliability: D

Major Data Source: Operation Dixie

Although these vessels have never been reported along Federation borders, it is quite possible that they could appear there at anytime. The only contact with one of these vessels has been through Operation Dixie. What is known about their combat capabilities is reflected in the data chart. It should be noted that the K-24 is very maneuverable and has powerful shields. There is insufficient data to suggest that more than one model is in existence. Intelligence reports show that these vessels are being produced at the Fonawl facility and, from there, being assigned to the coreward or spinward areas. A second facility may be located at Gerly, but this is unconfirmed. The class is named from the Klingon *kom kades*, which translates to "forever the winner".

Construction Data:

Model Numbers-	A
Ship Class-	VII
Date Entering Service-	2/1202
Number Constructed	120

Hull Data:

Superstructure Points-	12
Damage Chart-	C
Size	
Length-	98 meters
Width-	100 meters
Height-	24 meters
Weight-	81,000 tons
Cargo	
Cargo Units-	55 units
Cargo Capacity-	2,750 tons
Landing Capability-	Yes

Equipment Data:

Control Computer Type-	ZD-6
Transporters-	
Standard 6-person-	2
Combat 22-person-	none
Emergency 18-person-	1
cargo-	1
Cloaking Device Type-	None
Power Requirement-	None

Other Data:

Crew-	160
Passengers-	20
Shuttlecraft-	4

Engines and Power Data:

Total Power Units Available-	38
Movement Point Ratio-	3/1
Warp Engine Type-	KWC-2
Number-	2
Power Units Available-	18
Stress Charts-	L/O
Maximum Safe Cruising Speed-	Warp 8
Emergency Speed-	Warp 9
Impulse Engine Type-	KIB-2
Power Units Available-	2

Weapons and Firing Data:

Beam Weapon Type-	KD-6
Number-	4
Firing Arcs-	1f/p, 1f/s, 1p/a, 1s/a
Firing Chart-	T
Maximum Power-	6
Damage Modifiers	
+3	
+2	(1 - 18)
+1	

Shields Data:

Deflector Shield Type-	KSN
Shield Point Ratio-	2/3
Maximum Shield Power-	15

Defense Factor- 65.2

Weapon Damage Factor- 20.4

[<<<< GO BACK](#)

IMPORTANT NOTE:

It is entirely possible that you have surfed to this page from an internet portal and are now viewing this page without frames. **The STSSTCSMU&A is best viewed from within its own set of frames**, so [click here to jump to the main STSSTCSMU&A web page](#) and then [see the site as it was meant to be seen!](#)

K-27 'GRIM REAPER' CLASS ESCORT

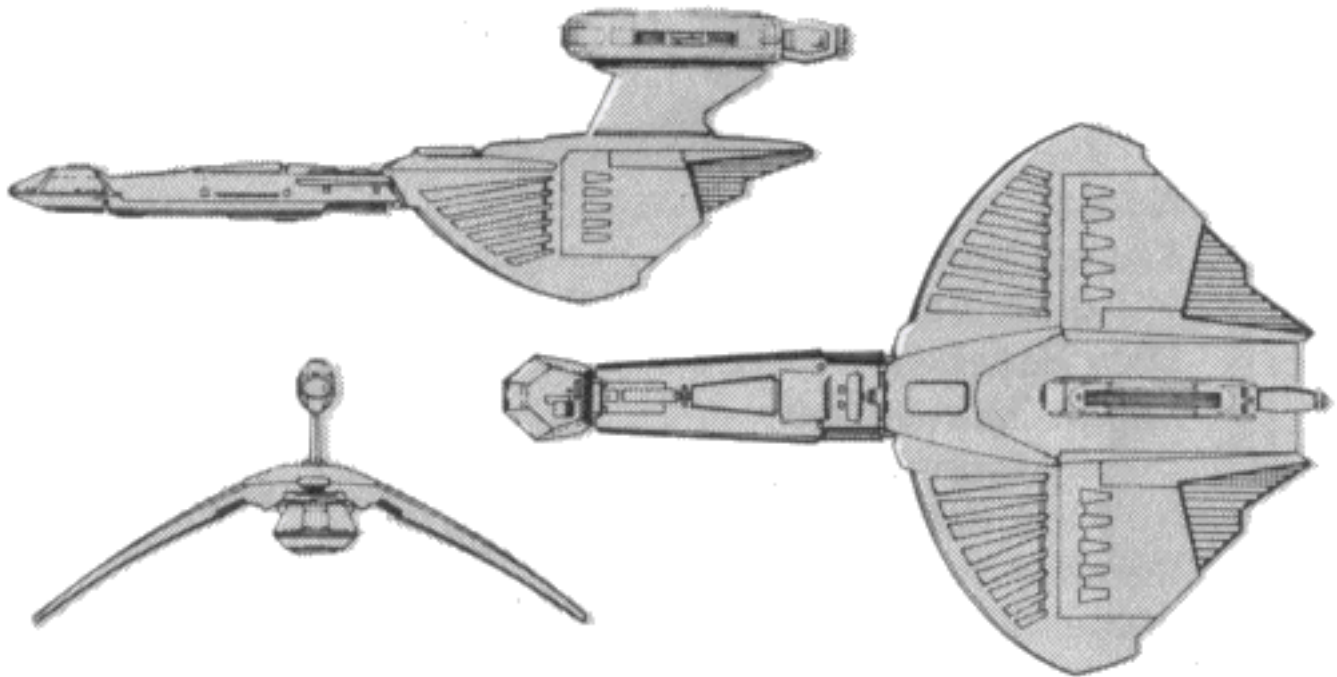

[Click here to view this ship in its own window](#)

BRAD'S COMMENTS: Clearly the best of the Klingon escorts. Maybe because the later model actually mounts a torpedo?? Seriously, that's probably my one big complaint about virtually all the smaller warships from all three of the manuals. Earth history has shown that the best weapon going for a small craft like a hydrofoil or a corvette is the torpedo (or missiles). Using a torpedo, such a small ship can get into the action fast, deliver a terrible blow, and then be gone again before the bigger ships even know what is going on. This tactic holds true in the STSSTCS as well, but most of the small warships don't use torpedoes. They should. After all, a torp takes very little power to arm, and produces a lot of damage, so it is a tremendous investment for fighting ships of this size. The Grim Reaper especially, which gets a major offensive gun in the form of its single torpedo bay. Throw in the cloaking device, and the later model K-27 is awesomely effective at hit-and-run sneak attacks. It looks cool too, with those predatory drooped wings and the lengthy neck. I've actually seen people scratchbuild models of this design; a testament to how good it looks?



From the FASA Star Trek KLINGON SHIP RECOGNITION MANUAL, circa 1985

K-27 (Grim Reaper) Class VI Escort

Known Sphere Of Operation: Romulan and coreward borders

Data Reliability: E

Major Data Source: Operation Dixie, Romulan Sector Intelligence

The K-27, encountered by two of the ships from Operation Dixie, has never been reported by any other Star Fleet vessels. Sub-space radio transmissions, intercepted during Operation Dixie, and information gained from Project Grey Ghost have supplied all the information to date.

The bridge section and boom of the K-27 is similar to that of the K-23, and much of this forward design appears to have been borrowed completely from the early models of the more-recognizable escort. As will be noticed in the data, the forward-mounted beam weapons are in the same locations and firing arcs as are those of the early K-23s. The most noticeable feature of the K-27 is the single warp engine. Mounted on a pylon at the rear of the vessel, it is capable of being jettisoned, leaving the ship mostly intact. As of this printing, it is unknown whether the bridge section can be detached.

The introduction of a second model around Stardate 2/19 indicates possible unsatisfactory performance by the original model. The only change reported by Operation Dixie was the exchange of the forward-firing KD-8 disrupter for a KP-2 torpedo. Sub-space communications also indicate that some of these vessels are equipped with the KCB cloaking device. Please note that if the vessel is operating with the cloak activated, it will be considerably harder to detect, due to the single engine.

Reports indicate 110 of these vessels in active service. Reports received from Project Grey Ghost suggest that some of these vessels may be operating on the Romulan border coreward. The manufacturing facility for these ships has not been located; however, the shipyard at Gerly is believed to be producing these vessels.

The name derives from the Klingon *mortum hesta*, which translates to "the maker of the dead".

Construction Data:

Model Numbers-	A	C
Ship Class-	VI	VI
Date Entering Service-	2/1604	2/1910
Number Constructed	100	40

Hull Data:

Superstructure Points-	16	16
Damage Chart-	C	C
Size		
Length-	160 meters	160 meters
Width-	110 meters	110 meters
Height-	55 meters	55 meters
Weight-	61,100 tons	60,650 tons
Cargo		
Cargo Units-	60 units	60 units
Cargo Capacity-	3,000 tons	3,000 tons
Landing Capability-	None	None

Equipment Data:

Control Computer Type-	ZD-5	ZD-5
Transporters-		
Standard 6-person-	2	2
Combat 22-person-	none	none
Emergency 18-person-	1	1
cargo-	1	1
Cloaking Device Type-	None	KCB
Power Requirement-	None	22

Other Data:

Crew-	155	157
Passengers-	20	20
Shuttlecraft-	3	3

Engines and Power Data:

Total Power Units Available-	36	36
Movement Point Ratio-	3/1	3/1
Warp Engine Type-	KWC-2	KWC-2
Number-	1	1
Power Units Available-	18	18
Stress Charts-	L/N	L/N
Maximum Safe Cruising Speed-	Warp 6	Warp 6
Emergency Speed-	Warp 7	Warp 7
Impulse Engine Type-	KIE-3	KIE-3
Power Units Available-	18	18

Weapons and Firing Data:

Beam Weapon Type-	KD-8	KD-8
Number-	3	2
Firing Arcs-	1p, 1f, 1s	1p, 1s
Firing Chart-	U	U
Maximum Power-	7	7
Damage Modifiers		
+3	(1 - 7)	(1 - 7)
+2	(8 - 15)	(8 - 15)
+1	(16 - 20)	(16 - 20)
Beam Weapon Type-	KD-12	KD-12
Number-	2	2
Firing Arcs-	A	A
Firing Chart-	H	H
Maximum Power-	9	9
Damage Modifiers		
+3	(1 - 3)	(1 - 3)
+2	(4 - 8)	(4 - 8)
+1	(9 - 10)	(9 - 10)
Missile Weapon Type-		KP-2
Number-		1
Firing Arcs-		F
Firing Chart-		H
Power To Arm-		1
Damage-		10

Shields Data:

Deflector Shield Type-	KSH	KSH
Shield Point Ratio-	2/3	2/3
Maximum Shield Power-	15	15

Defense Factor-	69.4	69.4
Weapon Damage Factor-	25.7	22.9

[<<<< GO BACK](#)

IMPORTANT NOTE:

It is entirely possible that you have surfed to this page from an internet portal and are now viewing this page without frames. **The STSSTCSMU&A is best viewed from within its own set of frames**, so [click here to jump to the main STSSTCSMU&A web page](#) and then [see the site as it was meant to be seen!](#)

L-6 'DEFENDER' CLASS FRIGATE

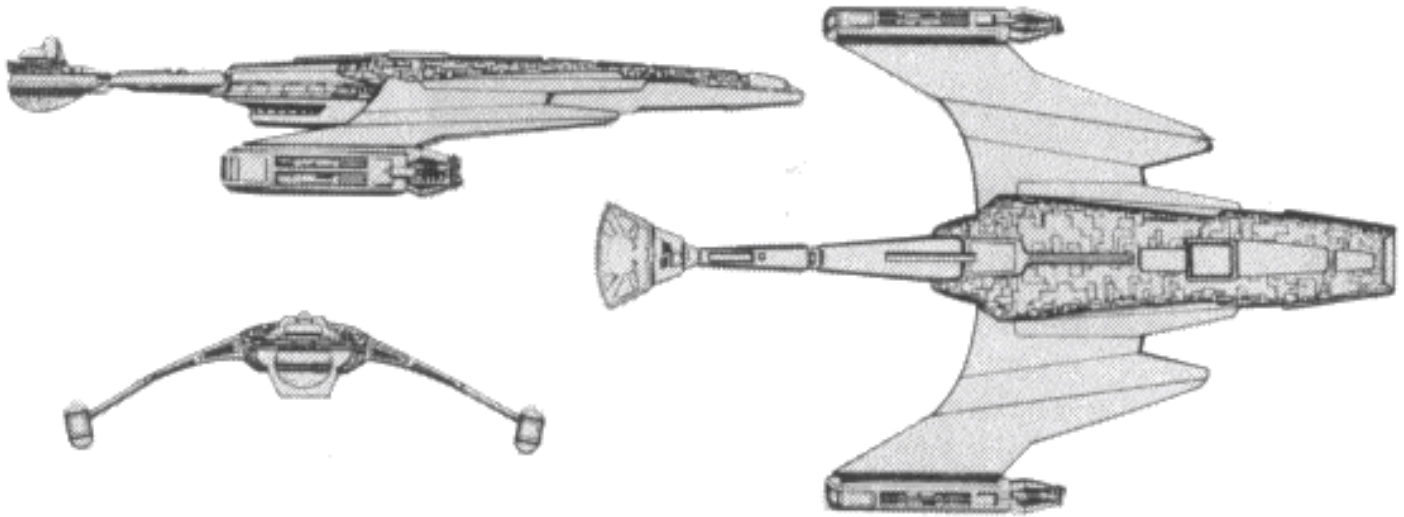

[Click here to view this class in its own window](#)

BRAD'S COMMENTS: An extremely sleek and predatory-looking design, this has always been one of my favorite Klingon frigates, in spite of the lack of a torpedo weapon. It's challenging to try and maneuver adequately and still have juice left over for disruptors and shields. I once wrote up a mildly-altered 'J' type using the official STSSTCS Construction Manual, and adding even low-yield torpedoes did marvels for this class's combat performance. I wish I'd kept that 'J' model stat sheet! I wrote it over ten years ago. That was a good fanship. Anyway, like I said, most of my warm feeling for this class has to do with its looks instead of its performance. I just love those curved-forward swoop wings!



From the FASA Star Trek KLINGON SHIP RECOGNITION MANUAL, circa 1985

L-6 (Defender) Class VIII - IX Frigate

Known Sphere Of Operation: Spinward and Coreward borders; Federation border

Data Reliability: C

Major Data Source: Klingon Sector Intelligence, Operation Dixie

The first encounters with the L-6 frigate came during the Four Years War. Though few of them were met in actual battle, those that did were usually victorious; none was ever captured and only three were destroyed. On Stardate 1/9602, in an engagement that was to typify all subsequent encounters with these vessels in the war, two Larson class destroyers and a Loknar class frigate were bludgeoned by a single L-6. The destroyers *Eylau* and *Jutland* were patrolling the outer fringes of the Falgor system, left behind with the frigate *Proxima* when the main body of the Federation fleet withdrew to reform and ready itself for the inevitable Klingon thrust. The destroyers encountered the L-6 as it entered the area, readied themselves for combat, and dispatched a message to the *Proxima* requesting assistance. The *Jutland* called for the Klingon vessel to surrender as it approached. The L-6 responded by firing on the *Eylau*, damaging its impulse drive system. The *Jutland* closed to extreme range and opened fire, but the damage it inflicted was negligible. While the Klingon ship was concentrating on the incoming *Jutland*, the *Eylau* managed to damage a warp engine, causing the L-6 to turn on the *Eylau* with a withering barrage, destroying the *Eylau's* warp drive controls and causing it to go dead in space. Once again, the *Jutland* fired to minimal effect, and the L-6 renewed its fire on the *Jutland*, which was no match for the Klingon frigate either in terms of firepower or range. The *Jutland* received one damaging blow after another, all from extreme range for its weapons. When the L-6 eventually closed for the kill, it was frustrated by the arrival of the *Proxima*. Approaching the Klingon from the rear, the *Proxima* closed rapidly and delivered a devastating blow to the engineering section, only to be surprised by the Klingon's aft-firing disruptors, which delivered a volley into the bridge and forced it to withdraw. Luckily for the Federation vessels, the moderately-damaged L-6 decided to withdraw, leaving the *Eylau* damaged beyond repair, the *Jutland* severely damaged, and the *Proxima* lightly damaged.

The L-6A went through an interesting change around Stardate 2/09, when the warp engines were changed from the KWD-1 to the KWE-1, and the impulse system was upgraded to the more powerful KIE-2. The warp engines delivered less power than the earlier designs but were more efficient. The impulse system increased its power output over the earlier system by 600%. The overall output of power decreased, however the maneuverability increased. Further changes included the addition of more troops and shuttlecraft as well as improved weaponry and shields. This modification did not alter the basic weakness in the L-6 design, its amidships warp engines.

Of the approximately 300 L-6s built, about 230 remain in active service and about 50 have been destroyed; the disposition of the remainder is unknown. Operation Dixie reports indicate that the L-6 is produced at the Kodal facility. The class name is translated from the Klingon *th'lar*.

Construction Data:

Model Numbers-	B	G	I
Ship Class-	VIII	VIII	IX
Date Entering Service-	1/9204-2/1006	2/0703	2/0911
Number Constructed	84	110	103

Hull Data:

Superstructure Points-	20	20	20
Damage Chart-	B	B	B
Size			
Length-	200 meters	200 meters	200 meters
Width-	120 meters	120 meters	120 meters
Height-	30 meters	30 meters	42 meters
Weight-	100,700 tons	101,600 tons	123,000 tons
Cargo			
Cargo Units-	140 units	140 units	140 units
Cargo Capacity-	7,000 tons	7,000 tons	7,000 tons
Landing Capability-	None	None	None

Equipment Data:

Control Computer Type-	ZD-5	ZD-5	ZD-5
Transporters-			
Standard 6-person-	4	4	4
Combat 22-person-	3	3	3
Emergency 18-person-	2	2	2
cargo-	2	2	2
Cloaking Device Type-	None	None	None
Power Requirement-	None	None	None

Other Data:

Crew-	300	310	335
Troops-	300	300	320
Passengers-	None	None	None
Shuttlecraft-	2	2	6

Engines and Power Data:

Total Power Units Available-	38	38	34
Movement Point Ratio-	4/1	4/1	3/1
Warp Engine Type-	KWD-1	KWD-1	KWE-1
Number-	2	2	2
Power Units Available-	18	18	11
Stress Charts-	L/N	L/N	I/L
Maximum Safe Cruising Speed-	Warp 6	Warp 6	Warp 6
Emergency Speed-	Warp 8	Warp 8	Warp 8
Impulse Engine Type-	KIB-2	KIB-2	KIE-2
Power Units Available-	2	2	12

Weapons and Firing Data:

Beam Weapon Type-	KD-6	KD-6	KD-6
Number-	2	4	8
Firing Arcs-	2f	4f	1f/p, 4f, 1f/s, 2a
Firing Chart-	T	T	T
Maximum Power-	6	6	6
Damage Modifiers			
+3			
+2	(1 - 18)	(1 - 18)	(1 - 18)
+1			
Beam Weapon Type-	KD-4	KD-7	
Number-	4	4	
Firing Arcs-	1f/p, 1f/s, 1a/p, 1a/s	2f, 2a	
Firing Chart-	J	L	
Maximum Power-	4	7	
Damage Modifiers			
+3			
+2	(1 - 10)	(1 - 8)	
+1		(7 - 12)	

Shields Data:

Deflector Shield Type-	KSE	KSJ	KSG
Shield Point Ratio-	1/1	2/3	1/2
Maximum Shield Power-	9	12	9

Defense Factor-	55.1	66.1	72.6
Weapon Damage Factor-	18.2	35.6	40.8

[<<<< GO BACK](#)

IMPORTANT NOTE:

It is entirely possible that you have surfed to this page from an internet portal and are now viewing this page without frames. **The STSSTCSMU&A is best viewed from within its own set of frames**, so [click here to jump to the main STSSTCSMU&A web page](#) and then [see the site as it was meant to be seen!](#)

L-9 'SABER' CLASS FRIGATE

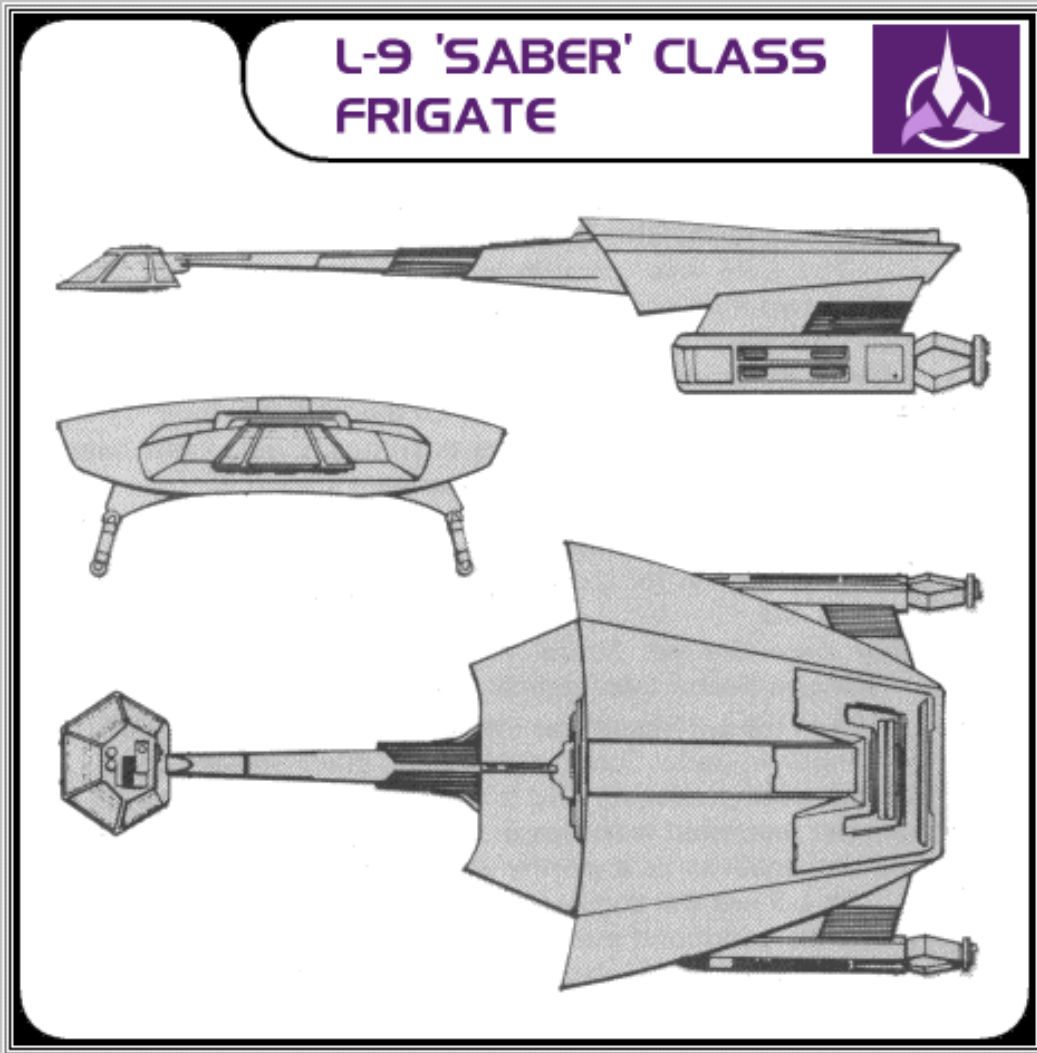

[Click here to view this class in its own window](#)

BRAD'S COMMENTS: A superb battlefield weapon during game play, this **ST:TOS** looking ship has as much punch as any big cruiser. Matches up well with the best of the big Federation ships like the [Constitution](#), [Enterprise](#), and [Reliant](#) classes.

Overpowers most other Federation ships one-on-one. Ditto against the Romulans. The punch from that KP-6 torpedo is hard to beat, the shields are strong, there is as much superstructure here as most decent capital ships, what more can you ask for?

Technically, as a "frigate", this ship ought to be much lighter and not nearly as powerful. I stated in my [rant on ship class confusion](#) that the writers of the FASA game did not seem to have a firm grasp of the terminology; either that or they are (strangely) trying to redefine what a "frigate" is. But why? If you're going to borrow naval terminology from Terran sailing history, it pays to at least try and adhere to the definitions as they once existed. Even though the differences between 20th century destroyers and frigates is not very clear, what is clear is that a frigate by 21st century Earth standards is a ship somewhat larger than a destroyer but not quite up there with a cruiser. Well, the L-9 kicks tail on most big cruisers!

The proof is in the pudding. Unlike most Klingon frigates, which operate best in trios while escorting larger cruisers, the L-9 needs no escort, and can be overwhelming if arrayed in twos or threes in any scenario. A game with 3 or more L-9's will be horribly lopsided unless you place equal opposition on the other side, typically [Chandley class](#) frigates and/or the Reliant or Enterprise class cruisers. So in raw gaming terms, you may as well treat this class as a heavy cruiser.

Cosmetically, I have always liked this vessel. Those angles and slab-sided hull look simplistic in true TOS-era spirit, but the crouched appearance, with the long thin boom neck and bulky, imposing secondary hull... I guess I just like it. And since it plays extremely well, there is not much to complain about where this class is concerned. Have fun. Ka'pla!

From the FASA Star Trek KLINGON SHIP RECOGNITION MANUAL, circa 1985

L-9 (Saber) Class X Frigate

Known Sphere Of Operation: Empire-wide use

Data Reliability: A for L-9A; B for L-98; D for L-9E, L-9F, E for L-9G

Major Data Source: Model A in Star Fleet possession; Klingon Sector Intelligence; Operation Dixie

When the L-9 frigate was introduced on Stardate 2/1507, the Klingon Imperial Command boasted that it was the finest warship ever produced, and it has indeed become one of the most respected warships in known space, proving itself time and again to be a worthy opponent.

The L-9 has the angular design of the earlier K-23 class escorts. Its command pod, like all others, can be jettisoned in emergencies and is capable of life support, limited maneuver, and even weapons fire for up to one year on its own. Engineering, located in the central aft section of the ship, has a secondary bridge used when the main bridge has suffered damage during combat or when the command pod has been separated. Located in the lower decks of the main hull are hypothermia capsules

that can be converted into temporary quarters for short missions. The shuttlebay is located forward of the engineering section, the shuttlecraft entering from the underside of the main hull. A total of six, and in earlier models eight, disruptors are mounted in the command pod and on the main hull near the where the boom attaches. A plasma weapon or forward-firing torpedoes are mounted in the lower portion of the main hull, and aft-firing weaponry (including two disruptors) is mounted in the lower rear of the main hull.

Sector Intelligence and Operation Dixie have revealed that L-9s are being produced at the facilities of Taamar, Fonawl, and Gnuu Re'. The latest estimates on production rate are 1 1 L-9s per year.

The class is named for the *sivista*, a dress sword worn by senior Klingon officers; the exact translation is "fast-sword."

The L-9A, commissioned on Stardate 2/1507, uses the KWE-2 warp drive system, which gives cruising speeds of Warp 7 and in emergency speeds of Warp B. Mounting four KD-8 and four KF-10 disruptors firing into the forward arc, the L-9A could deliver a devastating blow at close range; the KD-10 has an offensive range of only 60,000 km, however, and this forced the vessel to close with enemies to deliver its full punch, a drawback that made the L-9A an unpopular vessel. The new KSP deflector shield, using a trinary trans- former to deliver maximum shield strength at one-third the power cost, coupled with a reinforced superstructure, made the L-9A a formidable opponent.

The L-9A was commissioned an Stardate 2/1507 and withdrawn from service on Stardate 2/171 0, one of the shortest-lived warship models in any navy. Just eight months after its introduction, the L-9A was found to be ineffective in delivering long-range offensive strikes, but, until the facilities were retooled to replace the disruptors with the KD-13, production continued. Of the 32 L-9As built, 18 were converted to L-99s, 12 have been destroyed, 1 has been captured by Star Fleet, and 1 has been scrapped.

Although the L-9B is not the newest model, it is the most common. The only change this model incorporates is in the weapons system. The KD-1 0 disruptors were replaced by the KD-1 3, increasing the offensive range 350% and allowing the L-9 to deal with opposing capital ships at long range.

Of the 84 L-96s built, 66 remain in active service, 14 have been destroyed, 1 has been captured by the Romulans, 2 are listed as missing, and 1 is in the service of a ranking family of the Empire.

In the L-9C, an uprated impulse drive system was added to increase the total power output, but the warp envelope proved unstable, and it was not until the L-9E, mounting the KIE-2, that stability was achieved. The addition of the photon torpedo bays in the fore and aft positions made this model a feared opponent even though two disruptors were dropped from the weapon complement, best approached from the flank even though two of the forward firing disruptors were removed. The E also has a strengthened superstructure.

Of the approximately 25 L-9Es built, reports indicate that two have been destroyed. The disposition of the others is uncertain.

The L-9F mounts the more-powerful KWE-3 warp engines. Furthermore, the KD-1 3 disruptors have been changed to the KD-8, which does not have the extended range of the KD-13 but delivers a more powerful blow.

Of the approximately 25 L-9Fs built, all are believed to be in active service.

The L-9G is believed to have been responsible for the destruction of the ships of Operation Dixie, but reports confirming the existence of this model are not forthcoming. The model is believed to carry fewer troops than the other models, a reduction thought necessary to house the RPL-1 plasma weapon reportedly mounted in the lower main hull. These vessels are assumed to be operating along the Empire's coreward borders.

Construction Data:

Model Numbers-	A	B	E	F	G
Ship Class-	X	X	X	X	X
Date Entering Service-	2/1507-2/1510	2/1701	2/2003	2/2102	2/2106
Number Constructed	32	84	25	25	20

Hull Data:

Superstructure Points-	25	25	27	27	28
Damage Chart-	C	C	C	C	C
Size					
Length-	222 meters	222 meters	224 meters	224 meters	230 meters
Width-	106 meters	106 meters	106 meters	106 meters	106 meters
Height-	42 meters	42 meters	50 meters	50 meters	50 meters
Weight-	146,500 tons	147,350 tons	150,500 tons	151,000 tons	152,100 tons
Cargo					
Cargo Units-	180 units	180 units	160 units	160 units	60 units
Cargo Capacity-	9,000 tons	9,000 tons	8,000 tons	8,000 tons	3,000 tons
Landing Capability-	None	None	None	None	None

Equipment Data:

Control Computer Type-	ZD-7	ZD-7	ZD-7	ZD-7	ZD-7
Transporters-					
Standard 6-person-	3	3	3	3	3
Combat 22-person-	6	6	6	6	6
Emergency 18-person-	2	2	2	2	2
cargo-	2	2	2	2	2
Cloaking Device Type-	None	None	None	None	None
Power Requirement-	None	None	None	None	None

Other Data:

Crew-	420	420	432	435	450
Troops-	300	300	340	340	240
Shuttlecraft-	6	6	5	5	5

Engines and Power Data:

Total Power Units Available-	42	42	48	52	52
Movement Point Ratio-	4/1	4/1	4/1	4/1	4/1
Warp Engine Type-	KWE-2	KWE-2	KWE-2	KWE-3	KWE-3
Number-	2	2	2	2	2
Power Units Available-	18	18	18	20	20
Stress Charts-	J/M	J/M	J/M	J/M	J/M
Maximum Safe Cruising Speed-	Warp 7	Warp 7	Warp 7	Warp 7	Warp 7
Emergency Speed-	Warp 8	Warp 8	Warp 8	Warp 8	Warp 8
Impulse Engine Type-	KIE-1	KIE-1	KIE-2	KIE-2	KIE-2
Power Units Available-	6	6	12	12	12

Weapons and Firing Data:

Beam Weapon Type-	KD-8	KD-8	KD-8	KD-8	KD-8
Number-	6	6	6	8	8
Firing Arcs-	1f/p, 2f, 1f/s, 2a	1f/p, 2f, 1f/s, 2a	1f/p, 2f, 1f/s, 2a	2f/p, 2f, 2f/s, 2a	2f/p, 2f, 2f/s, 2a
Firing Chart-	U	U	U	U	U
Maximum Power-	7	7	7	7	7
Damage Modifiers					
+3	(1 - 7)	(1 - 7)	(1 - 7)	(1 - 7)	(1 - 7)
+2	(8 - 15)	(8 - 15)	(8 - 15)	(8 - 15)	(8 - 15)
+1	(16 - 20)	(16 - 20)	(16 - 20)	(16 - 20)	(16 - 20)
Beam Weapon Type-	KD-10	KD-13	KD-13		
Number-	4	4	2		
Firing Arcs-	1p, 2f, 1s	1f/p, 2f, 1f/s	1f/p, 1f/s		
Firing Chart-	C	X	X		
Maximum Power-	3	5	5		
Damage Modifiers					
+3		(1 - 7)	(1 - 7)		
+2		(8 - 15)	(8 - 15)		
+1	(1 - 6)	(16 - 22)	(16 - 22)		
Missile Weapon Type-					RPL-1
Number-					1
Firing Arcs-					F
Firing Chart-					E
Power To Arm-					10
Damage-					See Chart
Missile Weapon Type-			KP-6	KP-6	KP-6
Number-			2	2	2
Firing Arcs-			1f, 1a	1f, 1a	1f, 1a
Firing Chart-			R	R	R
Power To Arm-			2	2	2
Damage-			20	20	20

Shields Data:

Deflector Shield Type-	KSP	KSP	KSP	KSP	KSP
Shield Point Ratio-	1/3	1/3	1/3	1/3	1/3
Maximum Shield Power-	15	15	15	15	15

Defense Factor-

101.8	101.8	110.6	113.6	115.0
-------	-------	-------	-------	-------

Weapon Damage Factor-

39.4	59.4	59.8	60.6	58.6
------	------	------	------	------

[<<<< GO BACK](#)

IMPORTANT NOTE:

It is entirely possible that you have surfed to this page from an internet portal and are now viewing this page without frames. **The STSSTCSMU&A is best viewed from within its own set of frames**, so [click here to jump to the main STSSTCSMU&A web page](#) and then [see the site as it was meant to be seen!](#)

K-3 'KALATH' CLASS GUNBOAT

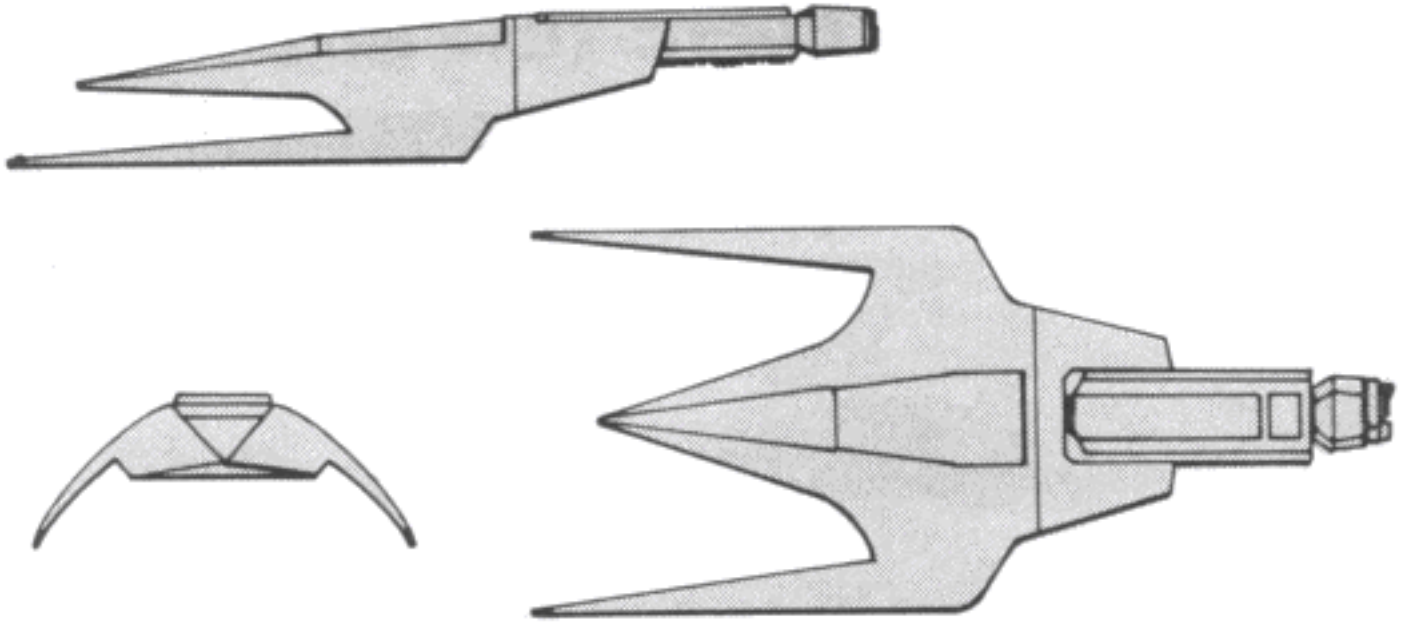

[Click here to view this class in its own window](#)

BRAD'S COMMENTS: Styled much like a TOS-era craft, this little ship is not much good against anything other than similarly dinky vessels. Even a modest cruiser can take out a K-3 with a few shots, so these ships are not much good for anything other than window dressing.



From the FASA Star Trek KLINGON SHIP RECOGNITION MANUAL, circa 1985

K-3 (Kalath) Class II Gunboat

Known Sphere Of Operation: Empire Interior

Data Reliability: A

Major Data Source: Vessel in Star Fleet possession

Of the 1802 K-3s built, 997 remain in active service, 222 are in reserve fleets, 18 are used as training vessels, 315 have been destroyed, 31 have been captured (14 by the Romulans, 9 by Star Fleet, 4 by private interests in the Triangle, and 4 by Orions), 27 are listed as missing, 123 were traded to the Romulans, 6 have been traded and 38 sold to private interests in the Triangle, 14 have been sold to Orions, and 11 have been sold to prominent families within the Empire. The K-3, formerly produced at Taamar, Gnuu Re', and Z'hai, is no longer in production.

The class is named for a small, nocturnal predator native to Veridor.

Construction Data:

Model Numbers-	A	B
Ship Class-	II	II
Date Entering Service-	1/8909-2/1106	1/9212
Number Constructed	466	1,336

Hull Data:

Superstructure Points-	3	3
Damage Chart-	C	C
Size		
Length-	53 meters	53 meters
Width-	23 meters	23 meters
Height-	9 meters	9 meters
Weight-	8,300 tons	8,500 tons
Cargo		
Cargo Units-	2 units	2 units
Cargo Capacity-	100 tons	100 tons
Landing Capability-	Yes	Yes

Equipment Data:

Control Computer Type-	ZD-2	ZD-2
Transporters-		
Standard 6-person-	1	1

Other Data:

Crew-	10	15
Passengers-	None	None
Shuttlecraft-	None	None

Engines and Power Data:

Total Power Units Available-	12	15
Movement Point Ratio-	1/1	1/1
Warp Engine Type-	KWA-2	KWB-2
Number-	1	1
Power Units Available-	10	12
Stress Charts-	P/Q	O/P
Maximum Safe Cruising Speed-	Warp 6	Warp 6
Emergency Speed-	Warp 7	Warp 7
Impulse Engine Type-	KIA-2	KIB-1
Power Units Available-	2	3

Weapons and Firing Data:

Beam Weapon Type-	KD-2	KD-2
Number-	2	2
Firing Arcs-	F	F
Firing Chart-	G	G
Maximum Power-	4	4
Damage Modifiers		
+3		
+2		
+1	(1 - 10)	(1 - 10)

Shields Data:

Deflector Shield Type-	KSB	KSC
Shield Point Ratio-	1/1	1/1
Maximum Shield Power-	10	11

Defense Factor-	35.8	40.8
Weapon Damage Factor-	2.8	2.8

[<<<< GO BACK](#)

IMPORTANT NOTE:

It is entirely possible that you have surfed to this page from an internet portal and are now viewing this page without frames. **The STSSTCSMU&A is best viewed from within its own set of frames**, so [click here to jump to the main STSSTCSMU&A web page](#) and then [see the site as it was meant to be seen!](#)

K-4 'ENFORCER' CLASS GUNBOAT

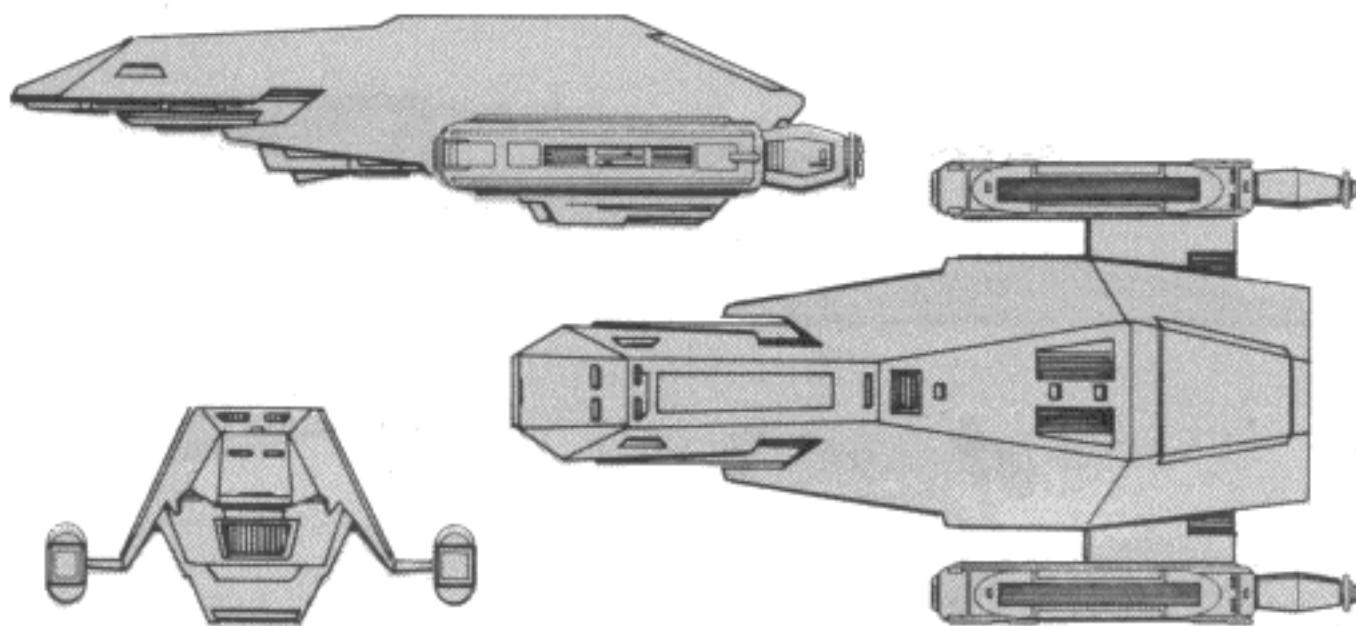

[Click here to view this class in its own window](#)

BRAD'S COMMENTS: Styled much like a TOS-era craft, this little ship is not much good against anything other than similarly dinky vessels. Even a modest cruiser can take out a K-3 with a few shots, so these ships are not much good for anything other than window dressing.



From the **FASA Star Trek KLINGON SHIP RECOGNITION MANUAL**, circa 1985

K-4 (Enforcer) Class II Gunboat

Known Sphere Of Operation: Empire-wide use.

Data Reliability: B

Major Data Source: Triangle Sector intelligence, Klingon Sector Intelligence

The K-4 gunboat/corvette, one of the most maneuverable vessels in known space, is designed to perform two different missions: in-system patrol duties or outpost/border patrol duties when acting as a gunboat, and rapid attack in mass assaults when acting as a corvette. When operating in its gunboat role, the K-4 carries a squad of six marines who are beamed aboard vessels that come under inspection, where they maintain order while the ship is being searched.

The vessel's usefulness as a corvette is exemplified by a search-and-destroy mission led by admiral Zantai Kaneida. On Stardate 2/1811, a small group of Klingon warships, including 25 K-4s, entered the Triangle to destroy or capture any Romulan forces they might encounter. This force enjoyed great success by using variations on a tactical plan, created by the Admiral himself. The plan called for the destroyers to meet and pin the enemy while the cruisers could maneuver into firing positions. When the cruisers began firing, the K-4s would rush in, concentrating their fire on single targets, then zoom away, only to come back again after another target. Whenever a target ship was assaulted by the K-4s, it was under such intense fire from a capital ship that it could not afford to redirect its fire into so many smaller targets. This tactic proved so successful that, although the mission lasted until Stardate 2/2009, only one cruiser, two destroyers, and seven K-4s were lost. Because of this, similar groups have been formed and can be seen operating along Federation borders and within the Triangle.

Of the 941 K-4s built, 331 As and 392 Bs remain in active service, 6 of each type are used as training vessels, 106 As and 63 Bs have been destroyed, 8 As and 3 Bs have been captured by the Romulans, 4 As

and 5 Bs have been captured by Star Fleet, and 1 A and 2 Bs have been captured by the Orions, 3 As and 7 Bs are listed as missing, and two each have been sold to ranking families within the Empire. The K-4 is manufactured at Iosia, Gnuu Re', Fonawl, and H'rez. The estimated rate of production is 50 per year.

The class is named from the translation of the Klingon *kl'xenova*.

Construction Data:

Model Numbers-	A	B
Ship Class-	II	II
Date Entering Service-	2/1103	2/1108
Number Constructed	461	480

Hull Data:

Superstructure Points-	3	4
Damage Chart-	C	C
Size		
Length-	56 meters	56 meters
Width-	28 meters	28 meters
Height-	14 meters	14 meters
Weight-	9,688 tons	11,008 tons
Cargo		
Cargo Units-	4 units	4 units
Cargo Capacity-	200 tons	200 tons
Landing Capability-	Yes	Yes

Equipment Data:

Control Computer Type-	ZD-2	ZD-2
Transporters-		
Standard 6-person-	1	1

Other Data:

Crew-	12	12
Passengers-	6	6
Shuttlecraft-	None	None

Engines and Power Data:

Total Power Units Available-	12	12
Movement Point Ratio-	1/2	1/2
Warp Engine Type-	KWA-1	KWA-1
Number-	2	2
Power Units Available-	5	5
Stress Charts-	O/P	O/P
Maximum Safe Cruising Speed-	Warp 7	Warp 7
Emergency Speed-	Warp 8	Warp 8
Impulse Engine Type-	KIA-2	KIA-2
Power Units Available-	2	2

Weapons and Firing Data:

Beam Weapon Type-	KD-2	KD-3
Number-	3	2
Firing Arcs-	2f/p/s, 1a/p/s	2f/p/s
Firing Chart-	G	I
Maximum Power-	4	5
Damage Modifiers		
+3		
+2		
+1	(1 - 10)	(1 - 12)
Beam Weapon Type-		KD-2
Number-		1
Firing Arcs-		a/p/s
Firing Chart-		G
Maximum Power-		4
Damage Modifiers		
+3		
+2		
+1		(1 - 10)

Shields Data:

Deflector Shield Type-	KSE	KSE
Shield Point Ratio-	1/1	1/1
Maximum Shield Power-	12	12

Defense Factor-	55.3	55.3
Weapon Damage Factor-	4.2	6.8

[<<<< GO BACK](#)

IMPORTANT NOTE:

It is entirely possible that you have surfed to this page from an internet portal and are now viewing this page without frames. **The STSSTCSMU&A is best viewed from within its own set of frames**, so [click here to jump to the main STSSTCSMU&A web page](#) and then [see the site as it was meant to be seen!](#)

K-5 'WATCHER' CLASS GUNBOAT

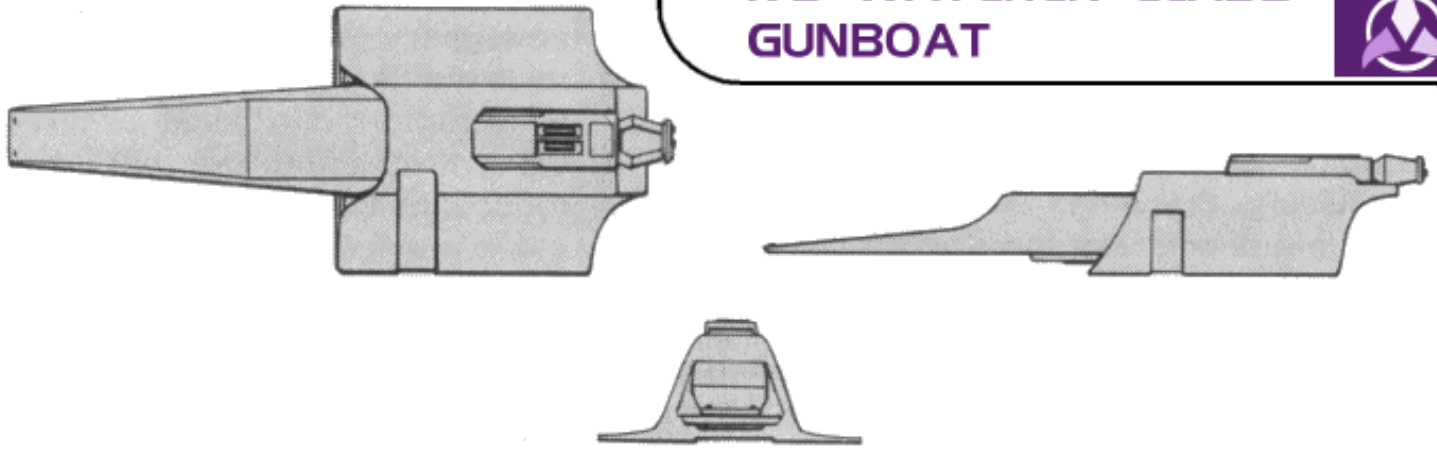

[Click here to view this ship in its own window](#)

BRAD'S COMMENTS: Styled much like a TOS-era craft, this little ship is not much good against anything other than similarly dinky vessels. Even a modest cruiser can take out a K-3 with a few shots, so these ships are not much good for anything other than window dressing.

From the FASA Star Trek KLINGON SHIP RECOGNITION MANUAL, circa 1985

K-5 (Watcher) Class II - III Gunboat

Known Sphere Of Operation: Empire-wide use

Data Reliability: A for K-5B; B for K-5C

Major Data Source: K-56 in Star Fleet possession; Klingon Sector Intelligence

Of the 765 K-5s built, 577 remain in active service, 8 are used as training vessels, 106 have been destroyed, 5 Bs have been captured by Star Fleet, 29 are listed as missing, 6 have been scrapped, 12 traded to elements in the Triangle, and 22 are in the service of prominent and ranking families within the Empire. K-5s are being produced at Iosia, Fonawl, and Z'hai at a rate of 40 per year. The class name is a translation of the Klingon *v'stato*.

Construction Data:

Model Numbers-	B	C
Ship Class-	II	III
Date Entering Service-	2/0711-2/1803	2/1404
Number Constructed	403	652

Hull Data:

Superstructure Points-	3	7
Damage Chart-	C	C
Size		
Length-	94 meters	96 meters
Width-	38 meters	38 meters
Height-	18 meters	20 meters
Weight-	12,950 tons	23,300 tons
Cargo		
Cargo Units-	15 units	15 units
Cargo Capacity-	750 tons	750 tons
Landing Capability-	Yes	Yes

Equipment Data:

Control Computer Type-	ZD-2	ZD-2
Transporters-		
Standard 6-person-	1	1

Other Data:

Crew-	18	18
Passengers-	6	6
Shuttlecraft-	None	None

Engines and Power Data:

Total Power Units Available-	14	15
Movement Point Ratio-	1/1	2/1
Warp Engine Type-	KWB-2	KWB-2
Number-	1	1
Power Units Available-	12	12
Stress Charts-	O/P	O/P
Maximum Safe Cruising Speed-	Warp 6	Warp 5
Emergency Speed-	Warp 7	Warp 6
Impulse Engine Type-	KIA-2	KIB-1
Power Units Available-	2	3

Weapons and Firing Data:

Beam Weapon Type-	KD-3	KD-12
Number-	2	2
Firing Arcs-	F	1f/s, 1f/p
Firing Chart-	I	H
Maximum Power-	5	9
Damage Modifiers		
+3		(1 - 3)
+2		(4 - 8)
+1	(1 - 12)	(1 - 12)

Shields Data:

Deflector Shield Type-	KSE	KSD
Shield Point Ratio-	1/1	1/2
Maximum Shield Power-	12	12

Defense Factor-	41.3	48.0
Weapon Damage Factor-	5.4	7.4

[<<<< GO BACK](#)

IMPORTANT NOTE:

It is entirely possible that you have surfed to this page from an internet portal and are now viewing this page without frames. **The STSSTCSMU&A is best viewed from within its own set of frames**, so [click here to jump to the main STSSTCSMU&A web page](#) and then [see the site as it was meant to be seen!](#)

K-6 'ADMINISTRATOR' CLASS GUNBOAT

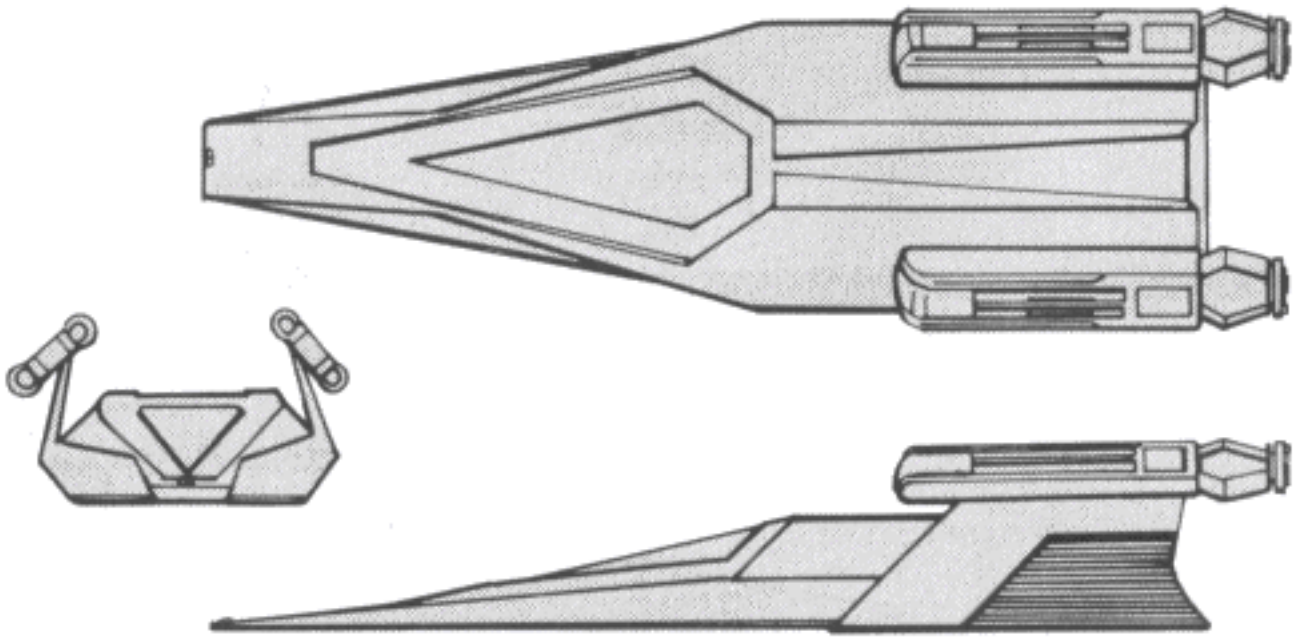

[Click here to view this class in its own window](#)

BRAD'S COMMENTS: Styled much like a TOS-era craft, this little ship is not much good against anything other than similarly dinky vessels. Even a modest cruiser can take out a K-3 with a few shots, so these ships are not much good for anything other than window dressing.



From the FASA Star Trek KLINGON SHIP RECOGNITION MANUAL, circa 1985

K-6 (Administrator) Class II - IV Gunboat

Known Sphere Of Operation: Empire-wide use

Data Reliability: A

Major Data Source: K-6A in Star Fleet possession; Orion Sector Intelligence, Klingon Sector Intelligence

K-6 gunboats are found in all areas of Klingon space, especially those occupied by servitor races, where it patrols star systems in groups of five looking for black-marketeers and others involved in illegal acts. It is not intended to deal with capital ships. The K-6 is particularly well known in the Triangle, where many operate, either under the Klingon banner or some other; recent information indicates that six of the Romulan version, the P-12, operate almost exclusively there.

The K-6A, introduced on Stardate 2/1102 at both Fonawl and Taamar, mounted the KWA-2 warp drive system. This was found to be inadequate for maneuvering the vessel, and the K-6B was designed with improved engines. Before this model was put into production, however, it was replaced with the K-6C, which had improved weapons and shield generators.

The K-6C is more maneuverable, has better than double the firepower, has shields that are 50% more efficient, and has a superstructure capable of taking twice as much damage. Refitting all existing vessels to this configuration was begun immediately, and was completed on Stardate 2/1901.

Of the 1043 K-6s built, 688 remain in active service, 8 are used as training vessels, 92 have been destroyed, 16 have been captured (8 by private interests in the Triangle, 4 by the Romulans, 2 by Orions and 2 by Star Fleet), 11 are listed as missing, 3 have been scrapped, 220 traded to the Romulans (all engines, weapons, and shield systems were removed), and 5 are in the service of a ranking family of the Empire. The K-6 is now being produced at the Taamar, Fonawl, and H'rez facilities at a rate of 60 per year.

The class name is translated from the Klingon *lar'hal*.

Construction Data:

Model Numbers-	A	C
Ship Class-	II	IV
Date Entering Service-	2/1102-2/1901	2/1306
Number Constructed	62	367

Hull Data:

Superstructure Points-	3	6
Damage Chart-	C	C
Size		
Length-	54 meters	55 meters
Width-	23 meters	23 meters
Height-	10 meters	10 meters
Weight-	14,600 tons	26,900 tons
Cargo		
Cargo Units-	16 units	13 units
Cargo Capacity-	800 tons	650 tons
Landing Capability-	Yes	Yes

Equipment Data:

Control Computer Type-	ZD-4	ZD-4
Transporters-		
Standard 6-person-	1	1

Other Data:

Crew-	8	9
Passengers-	4	4
Shuttlecraft-	None	None

Engines and Power Data:

Total Power Units Available-	22	20
Movement Point Ratio-	2/1	1/1
Warp Engine Type-	KWA-2	KWB-1
Number-	2	2
Power Units Available-	10	9
Stress Charts-	Q/R	O/Q
Maximum Safe Cruising Speed-	Warp 7	Warp 7
Emergency Speed-	Warp 8	Warp 8
Impulse Engine Type-	KIC-1	KIC-1
Power Units Available-	2	2

Weapons and Firing Data:

Beam Weapon Type-	KD-7	KD-7
Number-	1	2
Firing Arcs-	F	p/f/s
Firing Chart-	L	L
Maximum Power-	7	7
Damage Modifiers		
+3		
+2	(1 - 6)	(1 - 6)
+1	(7 - 12)	(7 - 12)
Beam Weapon Type-		KD-4
Number-		1
Firing Arcs-		A
Firing Chart-		J
Maximum Power-		4

Damage Modifiers

+3

+2

+1

(1 - 10)

Shields Data:

Deflector Shield Type-	KSM	KSJ
Shield Point Ratio-	1/1	2/3
Maximum Shield Power-	15	15

Defense Factor-	41.8	71.3
Weapon Damage Factor-	3.8	9.6

[<<<< GO BACK](#)

IMPORTANT NOTE:

It is entirely possible that you have surfed to this page from an internet portal and are now viewing this page without frames. **The STSSTCSMU&A is best viewed from within its own set of frames**, so [click here to jump to the main STSSTCSMU&A web page](#) and then [see the site as it was meant to be seen!](#)

K-14 'PATHMAKER' CLASS SCOUT

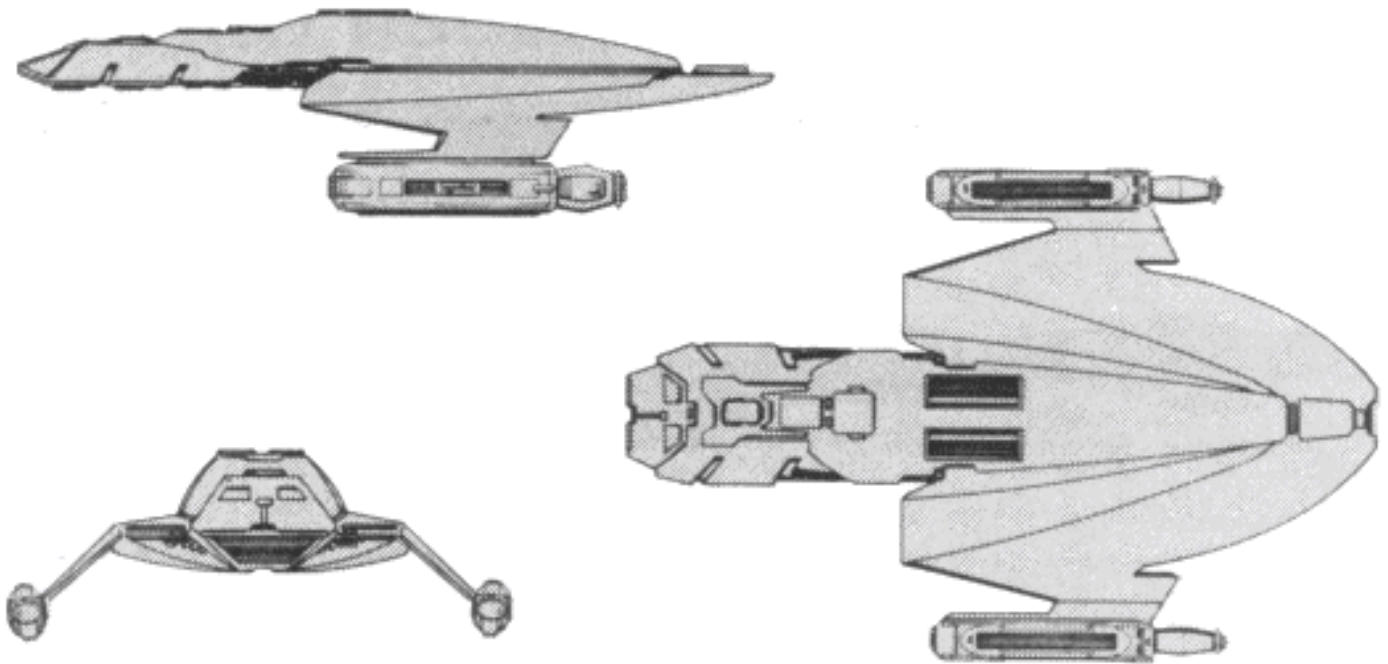

[Click here to view this ship in its own window](#)

BRAD'S COMMENTS: Not a bad little scout, the K-14 is roughly the equivalent of the Federation [Gagarin/Oberth](#) class ship. The G model is the most powerful from an offensive perspective, with its increased superstructure, better engines, and single torpedo. I have had a fair amount of success playing this class, especially in numbers against older Federation or Romulan cruisers as a poor man's light destroyer.

From the FASA Star Trek KLINGON SHIP RECOGNITION MANUAL, circa 1985

K-14 (Pathmaker) Class IV Scout

Known Sphere Of Operation: Coreward and Spinward areas

Data Reliability: D

Major Data Source: Operation Dixie

Of the approximately 350 K-14s built at Z'hai, intelligence reports indicate that about 225 of them remain in active service, and approximately 100 have been destroyed. The remaining dispositions are uncertain at the time of this printing. The class name is a rough translation of the Klingon *tas'esta*.

Construction Data:

Model Numbers-	A	C	G
Ship Class-	IV	IV	IV
Date Entering Service-	2/0209-1103	2/0902	2/1406
Number Constructed	105	105	100

Hull Data:

Superstructure Points-	6	7	8
Damage Chart-	B	B	B
Size			
Length-	145 meters	145 meters	145 meters
Width-	100 meters	100 meters	100 meters
Height-	35 meters	35 meters	35 meters
Weight-	27,050 tons	30,000 tons	32,300 tons
Cargo			
Cargo Units-	10 units	10 units	12 units
Cargo Capacity-	500 tons	500 tons	600 tons
Landing Capability-	Yes	Yes	Yes

Equipment Data:

Control Computer Type-	ZD-4	ZD-4	ZD-4
Transporters-			
Standard 6-person-	1	1	1
Emergency 18-person-	None	None	None
cargo-	None	None	None
Cloaking Device Type-	None	None	None
Power Requirement-	None	None	None

Other Data:

Crew-	16	16	17
Passengers-	None	None	None
Shuttlecraft-	1	1	1

Engines and Power Data:

Total Power Units Available-	20	27	27
Movement Point Ratio-	2/1	2/1	2/1
Warp Engine Type-	KWB-1	KWB-2	KWB-2
Number-	2	2	2
Power Units Available-	9	12	12
Stress Charts-	O/Q	P/Q	P/Q
Maximum Safe Cruising Speed-	Warp 6	Warp 8	Warp 8
Emergency Speed-	Warp 7	Warp 9	Warp 9
Impulse Engine Type-	KIC-1	KIB-1	KIB-1
Power Units Available-	2	3	3

Weapons and Firing Data:

Beam Weapon Type-	KD-4	KD-7	KD-7
Number-	3	3	3
Firing Arcs-	2f/p/s, 1a	2f/p/s, 1a	2f/p/s, 1a
Firing Chart-	J	L	L
Maximum Power-	4	7	7
Damage Modifiers			
+3			
+2		(1 - 6)	(1 - 6)
+1	(1 - 10)	(7 - 12)	(7 - 12)
Missile Weapon Type-			KP-1
Number-			1
Firing Arcs-			F
Firing Chart-			F
Power To Arm-			1
Damage-			6

Shields Data:

Deflector Shield Type-	KSI	KSM	KSJ
Shield Point Ratio-	1/1	1/1	2/3
Maximum Shield Power-	14	15	14
Defense Factor-	42.6	54.3	63.9
Weapon Damage Factor-	6.0	7.6	9.1

[<<<< GO BACK](#)

IMPORTANT NOTE:

It is entirely possible that you have surfed to this page from an internet portal and are now viewing this page without frames. **The STSSTCSMU&A is best viewed from within its own set of frames**, so [click here to jump to the main STSSTCSMU&A web page](#) and then [see the site as it was meant to be seen!](#)

K-15 'UNSEEN CREEPER' CLASS SCOUT

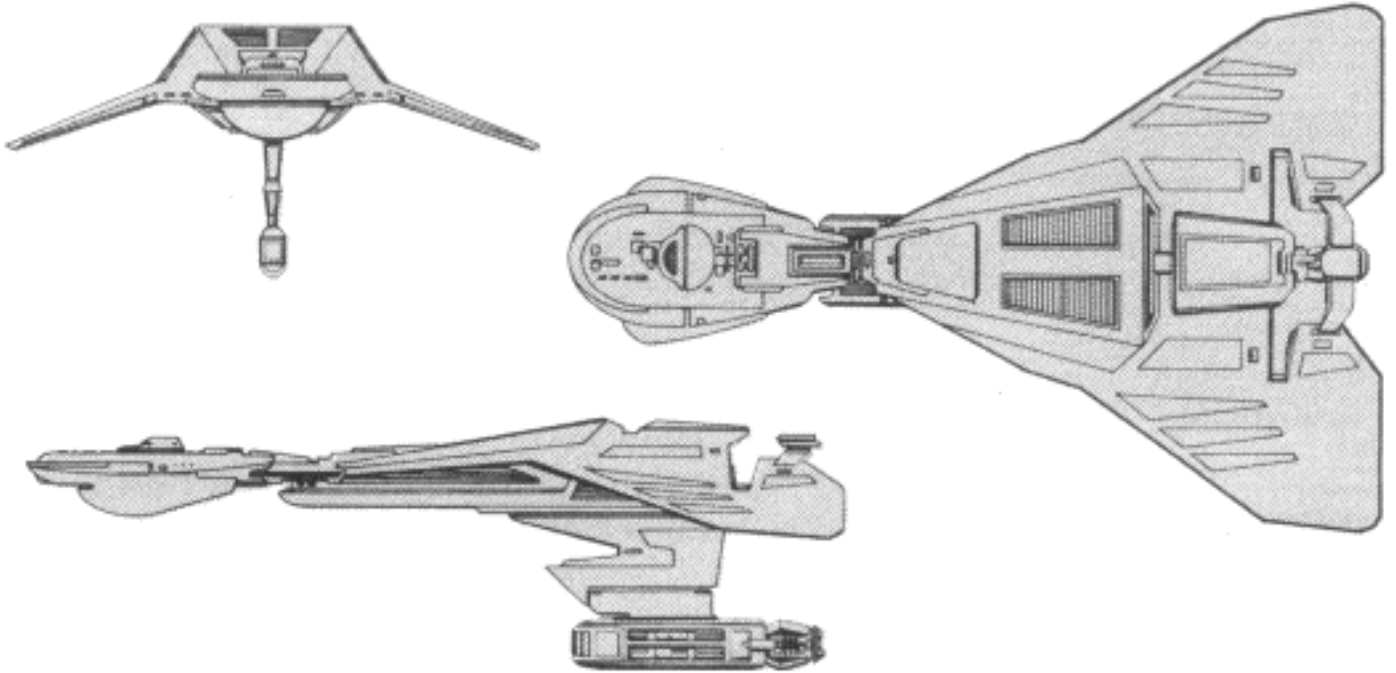

[Click here to see this ship in its own window](#)

BRAD'S COMMENTS: One of the better Klingon scouts, the F model of the K-15 is right up there with the "Bird of Prey" in terms of survivability in battle. Superstructure is good for a ship this small, and the power output to weapons ratio is good. As with the [Pathmaker](#) class ships, the K-15 can sometimes operate as a poor man's destroyer against underpowered older Federation and Romulan vessels.



From the FASA Star Trek KLINGON SHIP RECOGNITION MANUAL, circa 1985

K-15 (Unseen Creeper) Class IV - V Scout

Known Sphere Of Operation: Empire-wide use, frequently operates in Spinward frontiers and the Triangle

Data Reliability: A for K-15A; C for K-15D, K-15E

Major Data Source: K-15A in Star Fleet possession; Klingon Sector Intelligence, Triangle Sector Intelligence

The K-15 is the most likely Klingon scout vessel to be encountered anywhere in known space. Only the K-15D and K-15F models are in service at present, but newer models could appear at any time, as the design is well accepted by both officers and crew.

Of the 391 K-15s built, 196 Ds and 92 Fs remain in active service, 1 each are used as training vessels, 21 As, 19 Ds, and 14 Fs have been destroyed, 2As each have been captured by Star Fleet and the Romulans, 3 As, 14 Ds, and 9 Fs are listed as missing, 5 As and 2 Ds were traded to the Romulans, 2 Ds have been sold to private interests in the Triangle, 1 D has been sold to the Orions, and 3 Ds and 4 Fs have been sold to prominent families with the Empire. The K-15 is being produced at the Taamar and Gnuu Re' facilities. Combined annual production is 15 of each type.

The class name is a reference to the Klingon *//rexa*, which translates to 'slowly and unseen'.

Construction Data:

Model Numbers-	A	D	F
Ship Class-	IV	V	V
Date Entering Service-	2/0307-1202	2/1101	2/1505
Number Constructed	91	238	120

Hull Data:

Superstructure Points-	7	8	10
Damage Chart-	B	B	B
Size			
Length-	155 meters	155 meters	155 meters
Width-	100 meters	110 meters	110 meters
Height-	50 meters	50 meters	50 meters
Weight-	39,100 tons	41,100 tons	46,300 tons
Cargo			
Cargo Units-	20 units	30 units	30 units
Cargo Capacity-	1,000 tons	1,500 tons	1,500 tons
Landing Capability-	Yes	Yes	Yes

Equipment Data:

Control Computer Type-	ZD-3	ZD-4	ZD-4
Transporters-			
Standard 6-person-	1	1	1
Emergency 18-person-	None	None	None
cargo-	1	1	1
Cloaking Device Type-	None	None	None
Power Requirement-	None	None	None

Other Data:

Crew-	120	124	126
Passengers-	2	2	2
Shuttlecraft-	none	none	none

Engines and Power Data:

Total Power Units Available-	16	20	25
Movement Point Ratio-	2/1	2/1	2/1
Warp Engine Type-	KWC-1	KWC-2	KWC-3
Number-	1	1	1
Power Units Available-	14	18	22
Stress Charts-	K/N	L/N	L/M
Maximum Safe Cruising Speed-	Warp 7	Warp 7	Warp 7
Emergency Speed-	Warp 8	Warp 8	Warp 8
Impulse Engine Type-	KIC-1	KIC-1	KIB-1
Power Units Available-	2	2	3

Weapons and Firing Data:

Beam Weapon Type-	KD-3	KD-3	KD-7
Number-	4	4	4
Firing Arcs-	2f, 1a/p, 1a/s	2f, 1a/p, 1a/s	2f, 1a/p, 1a/s
Firing Chart-	I	I	L
Maximum Power-	5	5	7
Damage Modifiers			
+3			
+2			(1 - 6)
+1	(1 - 12)	(1 - 12)	(7 - 12)
Missile Weapon Type-			KP-2
Number-			1
Firing Arcs-			F
Firing Chart-			H

Power To Arm-			1
Damage-			10

Shields Data:

Deflector Shield Type-	KSI	KSJ	KSJ
Shield Point Ratio-	1/1	2/3	2/3
Maximum Shield Power-	14	14	14

Defense Factor-	41.5	53.4	60.8
Weapon Damage Factor-	10.8	10.8	18.5

[<<<< GO BACK](#)

IMPORTANT NOTE:

It is entirely possible that you have surfed to this page from an internet portal and are now viewing this page without frames. **The STSSTCSMU&A is best viewed from within its own set of frames**, so [click here to jump to the main STSSTCSMU&A web page](#) and then [see the site as it was meant to be seen!](#)

K-17 'DEATH STALKER' CLASS SCOUT

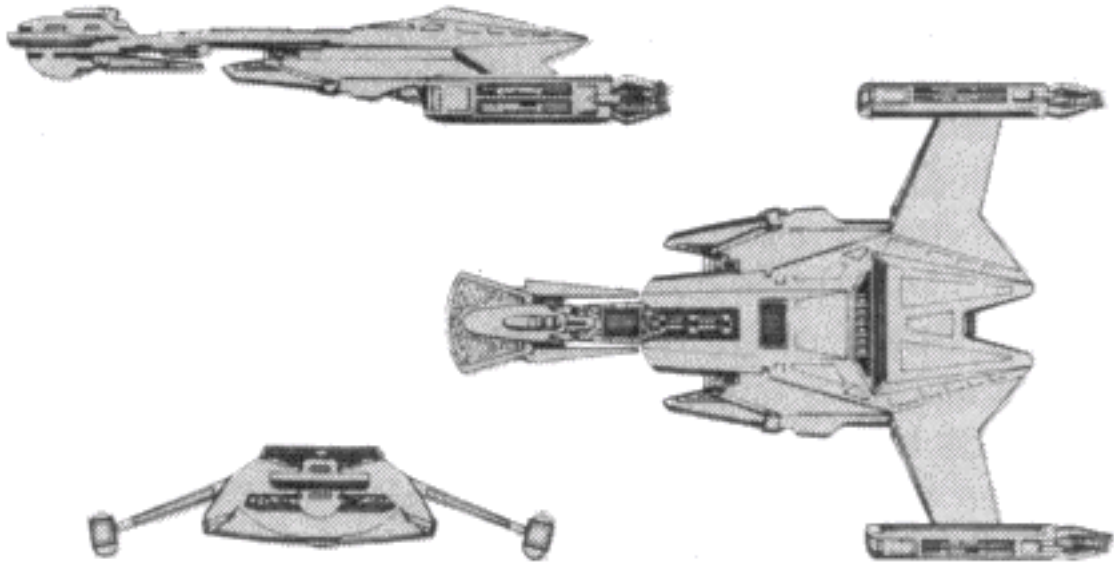

[Click here to view this ship in its own window](#)

BRAD'S COMMENTS: Underpowered, undergunned, underwhelming. A glorified gunboat? Never used it much, though it does look cool. Like most other small craft, its value would be doubled if it had at least one torpedo weapon. As it stands, this thing gets chopped down faster in a firefight than just about any other Klingon scout. They should have called it the "Target Practice" class!



From the FASA Star Trek KLINGON SHIP RECOGNITION MANUAL, circa 1985

K-17 (Death Stalker) Class III Escort

Known Sphere Of Operation: Triangle and Spinward areas

Data Reliability: A

Major Data Source: Vessels in Star Fleet possession

Of the 132 K-17s built at Taamar, 46 As and 21 Ds have been destroyed, 5 As and 2 Ds have been captured by Star Fleet, 3 As have been captured by the Romulans, 6 As and 3 Ds are listed as missing, 14 As and 16 Ds have been traded or sold to private interests in the Triangle, and 10 As and 2 Ds are in the service of ranking families in the Empire. The class name is a translation of the Klingon *z'mortama*.

Construction Data:

Model Numbers-	A	D
Ship Class-	III	III
Date Entering Service-	1/8808-2/0003	1/9612-2/0021
Number Constructed	84	44

Hull Data:

Superstructure Points-	5	5
Damage Chart-	C	C
Size		
Length-	130 meters	130 meters
Width-	90 meters	90 meters
Height-	20 meters	20 meters
Weight-	17,200 tons	23,150 tons
Cargo		
Cargo Units-	10 units	10 units
Cargo Capacity-	500 tons	500 tons
Landing Capability-	Yes	Yes

Equipment Data:

Control Computer Type-	ZD-4	ZD-3
Transporters-		
Standard 6-person-	1	1
Combat 22-person-	none	none
Emergency 18-person-	none	none
cargo-	none	none
Cloaking Device Type-	none	none
Power Requirement-	none	none

Other Data:

Crew-	14	14
Passengers-	none	none
Shuttlecraft-	none	none

Engines and Power Data:

Total Power Units Available-	23	21
Movement Point Ratio-	3/1	3/1
Warp Engine Type-	KWA-2	KWB1
Number-	2	2
Power Units Available-	10	9
Stress Charts-	Q/R	O/Q
Maximum Safe Cruising Speed-	Warp 6	Warp 7
Emergency Speed-	Warp 7	Warp 8
Impulse Engine Type-	KIA-3	KIA-3
Power Units Available-	3	3

Weapons and Firing Data:

Beam Weapon Type-	KD-1	KD-4
Number-	3	3
Firing Arcs-	2f, 1a	2f, 1a
Firing Chart-	B	J
Maximum Power-	4	4
Damage Modifiers		
+3	none	none
+2	none	none
+1	none	none

Shields Data:

Deflector Shield Type-	KSB	KSC
Shield Point Ratio-	1/1	1/1
Maximum Shield Power-	8	11

Defense Factor-	29.1	49.6
Weapon Damage Factor-	2.1	6.6

[<<<< GO BACK](#)

IMPORTANT NOTE:

It is entirely possible that you have surfed to this page from an internet portal and are now viewing this page without frames. **The STSSTCSMU&A is best viewed from within its own set of frames**, so [click here to jump to the main STSSTCSMU&A web page](#) and then [see the site as it was meant to be seen!](#)

K-30 'LUCKLESS' CLASS MONITOR

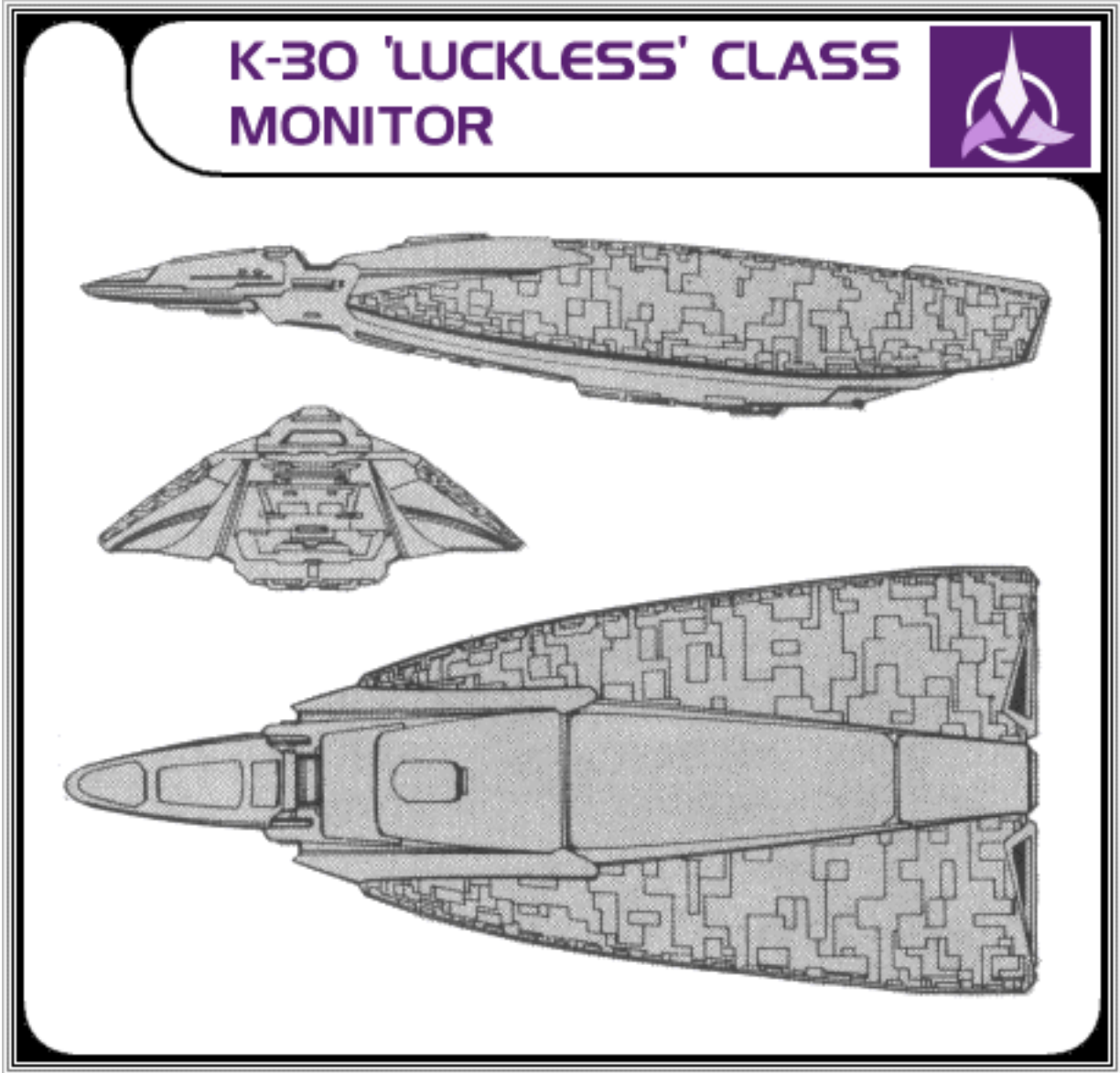

[Click here to view this ship in its own window](#)

BRAD'S COMMENTS: Can you say butt-freaking-ugly? The Luckless is aptly named, as it is one dog of a ship both in terms of looks and its terms of fighting capacity. It does not have enough power to energize shields or weapons sufficiently if it needs to maneuver, but unless it can maneuver it is a sitting duck because without a torpedo the class is outmatched by most other ships of a similar size. I rarely ever play this ship class.



From the FASA Star Trek KLINGON SHIP RECOGNITION MANUAL, circa 1985

K-30 (Luckless) Class IV Monitor

Known Sphere Of Operation: Orion space and the Triangle

Data Reliability: A

Major Data Source: K-30A and K-30E in Star Fleet possession

The K-30 was introduced into service to replace the obsolete K-12 monitor, which was unable to operate alone, due to the lack of sufficient maneuvering capability and weaponry. The Empire was expanding at a very rapid pace and needed modern, cost-efficient ships that could operate alone. On Stardate 1/9001, the first of the K-30s were commissioned into service from the Taamar shipyards.

Not long after the commissioning ceremonies, an incident occurred that was an omen for the K-30's future. A special carrier had been built to move the K-30s to their duty stations. While the first five monitors were being loaded onto one of these carriers, a collision occurred between two of them. Within one year, five of the 20 K-30s produced at Taamar had been destroyed, only one by hostile action. The class was building a reputation for being accident-prone. To add to the reputation, the K-30B and K-30C repeatedly failed tests of their new sub-light engines and were never put into production. The K-30D prototype, with the

new sub-light engine and a new shield generator, suffered several mishaps, one of which damaged the ship so badly that a replacement had to be built. During the final stages of construction, the engine contractor had come up with an improved version of the original design and supplied it instead. The new prototype with the replacement engine, now the K-30E, was successfully tested, but, on Stardate 1/9804, the first five production models were destroyed in a mysterious explosion during loading operations. A prevalent Klingon nickname for the class refers to this series of events; oftimes called *Knel* ("spell"), the ships of this class are not liked by most Klingon captains and crews.

The production of the K-30 was halted on Stardate 2/0110 in favor of a newer design. As the K-30s were replaced, they were sold or traded. Of the 244 K-30s built at Taamar, 132 were destroyed, 11 have been captured by Star Fleet, 6 are listed as missing, 51 have been scrapped, 9 have been traded to the Orions and 8 to private interests in the Triangle, and 22 have been sold to private interests in the Triangle and 5 to the Orions.

Construction Data:

Model Numbers-	A	E
Ship Class-	IV	IV
Date Entering Service-	1/9001-2/0202	1/9804-2/0901
Number Constructed	172	72

Hull Data:

Superstructure Points-	8	10
Damage Chart-	C	C
Size		
Length-	106 meters	106 meters
Width-	46 meters	46 meters
Height-	20 meters	20 meters
Weight-	27,900 tons	25,200 tons
Cargo		
Cargo Units-	20 units	20 units
Cargo Capacity-	1,000 tons	1,000 tons
Landing Capability-	Yes	Yes

Equipment Data:

Control Computer Type-	ZD-3	ZD-4
Transporters-		
Standard 6-person-	1	1
Combat 22-person-	None	None
Emergency 18-person-	None	None
cargo-	None	None
Cloaking Device Type-	None	None
Power Requirement-	None	None

Other Data:

Crew-	30	30
Passengers-	10	10
Shuttlecraft-	1	1

Engines and Power Data:

Total Power Units Available-	20	26
Movement Point Ratio-	2/1	2/1
Warp Engine Type-	KSLA	KSLB
Number-	2	2
Power Units Available-	9	12
Stress Charts-	J/M	K/N
Maximum Safe Cruising Speed-	Warp 6	Warp 6
Emergency Speed-	Warp 8	Warp 8
Impulse Engine Type-	KIC-1	KIC-1
Power Units Available-	2	2

Weapons and Firing Data:

Beam Weapon Type-	KD-2	KD-3
Number-	7	6
Firing Arcs-	2f/p, 2f, 2f/s, 1a	2f/p, 2f, 2f/s
Firing Chart-	G	I
Maximum Power-	4	5
Damage Modifiers		
+3		
+2		
+1	(1 - 10)	(1 - 12)
Beam Weapon Type-		KD-2
Number-		1
Firing Arcs-		A
Firing Chart-		G
Maximum Power-		4
Damage Modifiers		
+3		
+2		
+1		(1 - 10)

Shields Data:

Deflector Shield Type-	KSC	KSJ
Shield Point Ratio-	1/1	2/3
Maximum Shield Power-	11	14

Defense Factor- 41.4 61.5

Weapon Damage Factor- 9.8 17.6

[<<<< GO BACK](#)

IMPORTANT NOTE:

It is entirely possible that you have surfed to this page from an internet portal and are now viewing this page without frames. **The STSSTCSMU&A is best viewed from within its own set of frames**, so [click here to jump to the main STSSTCSMU&A web page](#) and then [see the site as it was meant to be seen!](#)

K-32 'STRONG VICTOR' CLASS MONITOR

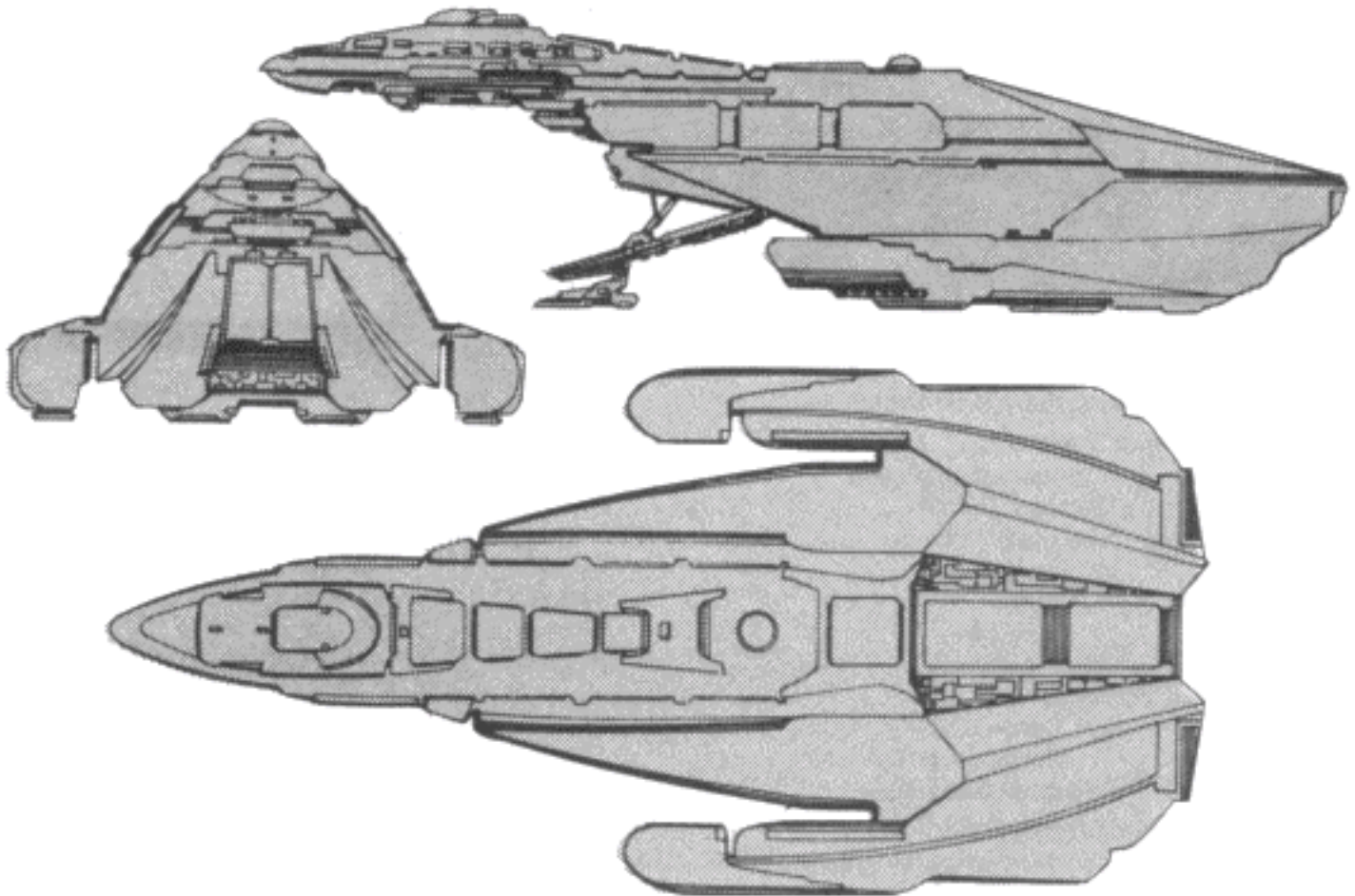

[Click here to view this class in its own window](#)

BRAD'S COMMENTS: A weird-looking class, the K-32 is a little more effective than its sibling the [Luckless](#). Like most small ships, this craft will function best in groups, usually three to six, and can actually take on some of the older destroyers and frigates amongst the enemy fleets. However, as an offensive weapon, the K-32 is not the best ship of choice. Better to pick a destroyer or small frigate.



From the FASA Star Trek KLINGON SHIP RECOGNITION MANUAL, circa 1985

K-32 (Strong Victor) Class IV Monitor

Known Sphere Of Operation: Empire-wide use

Data Reliability: B

Major Data Source: Klingon Sector Intelligence After the Four Years War, the Klingons began to feel the need for more monitors not only to replace the many that had been destroyed, but also to patrol their substantial gain of territory. The K-32 was introduced to solve two problems: to increase the Klingon presence around their servitor territories and to replace the highly unpopular K-30. Ships of this class carry a squad of ten marines for security reasons and possible boarding actions.

After many failures, the KSLB was perfected and installed on the K-32A, allowing it to maneuver well while devoting sufficient power to the offensive systems. The weapons arrangement is highly effective, giving the ability to discharge six disruptors in either the forward or aft arcs.

Of the 571 K-32s built, 279 As and 199 Bs remain in active service, 2 each are used as training vessels, 33 As and 21 Bs have been destroyed, 2 As and 1 B have been captured by private interests in the Triangle, 2

As and 3 Bs are listed as missing, 7 As and 1 0 Bs have been sold or traded to private interests in the Triangle, and 6 As and 4 Bs are in the service of prominent and ranking families of the Empire.

The K-32s are produced at Taamar and H'rez. The combined rate of production is 15 of each type per year.

The class name is a translation of the Klingon *v'al'kon*.

Construction Data:

Model Numbers-	A	B
Ship Class-	IV	IV
Date Entering Service-	2/0105	2/0710
Number Constructed	331	240

Hull Data:

Superstructure Points-	10	10
Damage Chart-	C	C
Size		
Length-	110 meters	110 meters
Width-	52 meters	52 meters
Height-	30 meters	30 meters
Weight-	35,700 tons	36,700 tons
Cargo		
Cargo Units-	42 units	42 units
Cargo Capacity-	2,100 tons	2,100 tons
Landing Capability-	Yes	Yes

Equipment Data:

Control Computer Type-	ZD-4	ZD-4
Transporters-		
Standard 6-person-	1	1
Combat 22-person-	None	None
Emergency 18-person-	None	None
cargo-	None	None
Cloaking Device Type-	None	None
Power Requirement-	None	None

Other Data:

Crew-	32	34
Passengers-	10	10
Shuttlecraft-	1	1

Engines and Power Data:

Total Power Units Available-	27	27
Movement Point Ratio-	2/1	2/1
Warp Engine Type-	KSLB	KSLB
Number-	2	2
Power Units Available-	12	12
Stress Charts-	K/N	K/N
Maximum Safe Cruising Speed-	Warp 6	Warp 6
Emergency Speed-	Warp 8	Warp 8
Impulse Engine Type-	KIB-2	KIB-2
Power Units Available-	3	3

Weapons and Firing Data:

Beam Weapon Type-	KD-7	KD-7
Number-	4	4
Firing Arcs-	2f/p, 2f/s	2f/p, 2f/s
Firing Chart-	L	L
Maximum Power-	7	7
Damage Modifiers		
+3		
+2		
+1	(1 - 10)	(1 - 10)
Beam Weapon Type-	KD-2	KD-4
Number-	4	4
Firing Arcs-	2p/a, 2s/a	2p/a, 2s/a
Firing Chart-	G	J
Maximum Power-	4	4
Damage Modifiers		
+3		
+2		
+1	(1 - 10)	(1 - 10)

Shields Data:

Deflector Shield Type-	KSJ	KSD
Shield Point Ratio-	2/3	1/2
Maximum Shield Power-	14	11

Defense Factor-	62.3	67.3
Weapon Damage Factor-	20.8	23.2

[<<<< GO BACK](#)

IMPORTANT NOTE:

It is entirely possible that you have surfed to this page from an internet portal and are now viewing this page without frames. **The STSSTCSMU&A is best viewed from within its own set of frames**, so [click here to jump to the main STSSTCSMU&A web page](#) and then [see the site as it was meant to be seen!](#)

Z-4 'DEATHGAME' CLASS DEFENSE OUTPOST

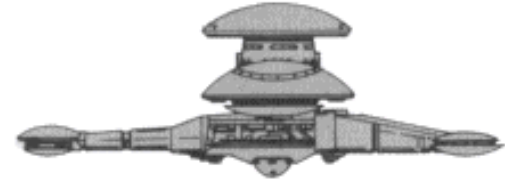
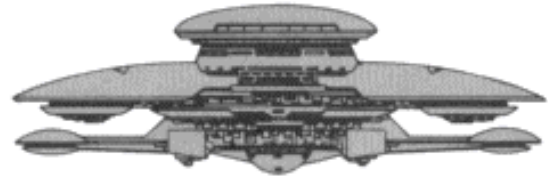
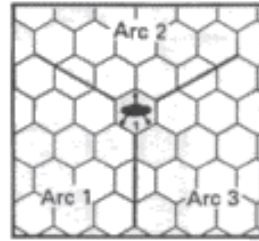
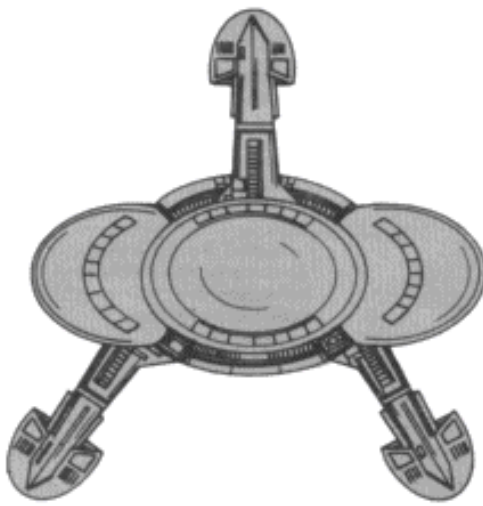

[Click here to view this class in its own window](#)

BRAD'S COMMENTS: Not until the ultra-powerful ships of the TNG Officers Manual does the STSSTCS start to see vessels capable of matching the likes of the Z-4. During game play, these outposts are hard to wield, if only because they are miserable offensive weapons thanks to their ponderous movement ratios. Creeping at a snail's pace, the Z-4 is usually best left orbiting a planet or perhaps minding an asteroid field; the literal 'big stick' under the table that can be taken out and used to wallop aggressors who stray too close to a highly-protected area or objective. The Z-4 is also something of a space station, and might be thought of as a dual-role model (like all defense outposts) in that it can, in theory, repair starships in the same fashion as mobile repair facilities, like a spacedock. However, it should be stressed that this is merely my opinion, and there are no official game rules that I have ever found confirming my belief.

Best advice to the player taking on an opponent with a Z-4: assault in numbers. Single ships, even an [Excelsior class](#), can usually not combat the Z-4 ship to ship. And even then, with multiple attackers, expect heavy losses during an assault.

The most interesting, and lengthy, scenarios I have ever played with this class have involved posing two forces against each other along the Klingon neutral zone: a Starfleet [Alamo outpost](#) and its contingent of ships, versus a Z-4 and its contingent of Klingon vessels. Attrition almost always kills off all the other ships until both outposts are forced to creep towards each other from opposite sides of the starmap, lobbing shots and hoping to score lucky strikes before they each close to killing distance and mutually annihilate one another.

In relation to the movies and TV series themselves, one always wonders if the Z-4 and other outposts like it are the equivalent of the huge [Earth Spacedock](#) or the [Nor class Cardassian stations](#), aka: Deep Space Nine? What about the older [Deep Space Station K7](#) from [ST:TOS](#)? Also, could defense outposts be thought of as actual *starbases*? My only answer to these questions is that I think the defense outpost, as built for the STSSTCS, is a pint-sized version of a Spacedock, not as large or as heavily armed, and probably not capable of all the same functions. And as for outposts being equivalent to starbases, well, it seems to me having seen the vast majority of Star Trek episodes on TV and in film, a 'starbase' is a planetary installation that may or may *not* have a companion space station orbiting overhead. So a defense outpost might function as *part* of a starbase, without actually being the starbase itself.

Again, this is just my speculation. (see more of my comments on space stations and defense outposts at the Federation [Alamo](#), [R-1](#), and [Spacedock](#) pages!)



From the FASA Star Trek KLINGON SHIP RECOGNITION MANUAL, circa 1985

Z-4 (Deathgame) Defense Outpost

Known Sphere Of Operation: Federation & Romulan Borders

Data Reliability: C

Major Data Source: Klingon Sector Intelligence

NOTES: Being introduced on stardate 1/8902, five years prior to the outbreak of the Four Years War, the Klingons began to supplement their border listening posts with the Z-4. These fortresses were placed in the areas where the Klingons wished to deny or restrict enemy movement. Since their introduction, the Klingons have constantly added to their number. Major defense points (such as starbases) will have more than one Z-4. Several points along the Federation and Triangle border are known to have as many as eight, each giving the others covering fire.

The Z-4 is so large that it must be built in place; if one must ever be moved, it is disassembled into six different sections and each one brought to the new location. Most of these outposts are found within a planetary system, but some areas requiring defensive boundaries do not have this luxury.

When first introduced, the Z-4 was capable of fulfilling its mission completely as designed, but with ships becoming more and more powerful, it was inevitable that they be upgraded. The Z-4B remained in service for 30 years before all were replaced with the Z-4C. On stardate 2/1403 the upgraded Z-4C was introduced, with the newly produced KMAPG-3 warp system and KIPG-3 impulse deck, both of which offered sizeable energy production increases compared to the Z-4B model. Also improved were the type and number of disruptors, as well as the addition of a potent torpedo model, the KP-6, which does as much damage as the fell Federation FP-4 torpedo. With this increase in weaponry, and an offensive range of 200,000 km, the Z-4C is not a likely target for small groups of ships.

Since the introduction of the Z-4C, the production rate has averaged 23 per year. Reports indicate that a faction within the Triangle is attempting to purchase one of these facilities. In the Klingon navy, command of these outposts is not sought after. The duty is considered to be demeaning as it doesn't allow many chances, if any, for glory in combat. The commanders of these bases have a great deal of power in their hands nevertheless. The bases are usually accompanied by repair facilities and other much needed diversions for front line units, all under the base commander's jurisdiction. The name is a translation of the Klingon *zha mortas*.

Construction Data:

Model Numbers-	B	C
Ship Class-	n/a	n/a
Date Entering Service-	1/8902-2/1911	2/1403
Number Constructed	311	201

Hull Data:

Superstructure Points-	60	70
Damage Chart-	C	C
Size		
Length-	320 meters	320 meters
Width-	300 meters	300 meters
Height-	110 meters	110 meters
Weight-	1,800,000 tons	1,850,000 tons
Cargo		
Cargo Units-	1,100 units	1,200 units
Cargo Capacity-	55,000 tons	60,000 tons
Landing Capability-	None	None

Equipment Data:

Control Computer Type-	ZD-5A	ZD-8
Transporters-		
Standard 6-person-	6	6
Combat 22-person-	4	4
Emergency 18-person-	4	4
cargo-	3	3
Cloaking Device Type-	NONE	NONE
Power Requirement-	NONE	NONE

Other Data:

Crew-	440	455
Troops-	none?	none?
Passengers-	260	260
Shuttlecraft-	24	24

Engines and Power Data:

Total Power Units Available-	164	198
Movement Point Ratio-	10/1	10/1
Warp Engine Type-	KMAPG-2	KMAPG-3
Number-	1	1
Power Units Available-	144	170
Stress Charts-	?	?
Maximum Safe Cruising Speed-	none	none
Emergency Speed-	none	none
Impulse Engine Type-	KIPG-2	KIPG-3
Power Units Available-	20	28

Weapons and Firing Data:

Beam Weapon Type-	KD-6	KD-8
Number-	12	18
Firing Arcs-	4 per each arc	6 per each arc
Firing Chart-	T	U
Maximum Power-	6	7
Damage Modifiers		
+3	(1 - 3)	(1 - 7)
+2	(4 - 8)	(8 - 15)
+1	(9 - 10)	(16 - 20)
Beam Weapon Type-		KD-12
Number-		9
Firing Arcs-		3 per each arc
Firing Chart-		H
Maximum Power-		9
Damage Modifiers		
+3		(1 - 3)
+2		(4 - 8)
+1		(9 - 10)
Missile Weapon Type-		KP-6
Number-		6
Firing Arcs-		2 per each arc
Firing Chart-		H
Power To Arm-		2
Damage-		20
Shields Data:		
Deflector Shield Type-	KS	KS
Shield Point Ratio-	1/2	1/2
Maximum Shield Power-	15	15
Defense Factor-	153.8	178
Weapon Damage Factor-	83.4	178.5

[<<<< GO BACK](#)

IMPORTANT NOTE:

It is entirely possible that you have surfed to this page from an internet portal and are now viewing this page without frames. **The STSSTCSMU&A is best viewed from within its own set of frames**, so [click here to jump to the main STSSTCSMU&A web page](#) and then [see the site as it was meant to be seen!](#)

W-2 'KOREBA' CLASS SHUTTLE

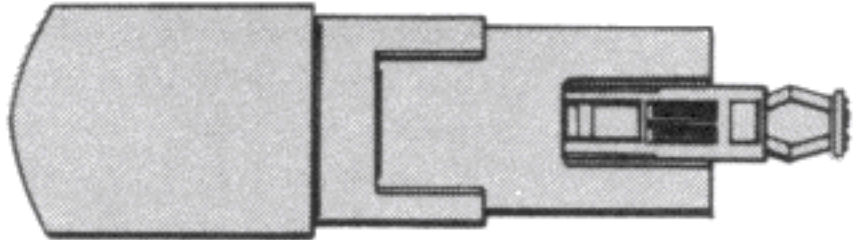
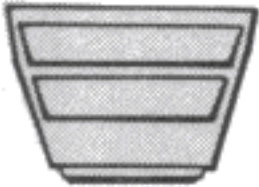

[Click here to view this class in its own window](#)

BRAD'S COMMENTS: Warp shuttle design, has a slab-sided TOS feel to it. Amazingly, the Klingon warp shuttles and tenders are all armed! Why arm these little guys and not the freighters? C'mon.



From the FASA Star Trek KLINGON SHIP RECOGNITION MANUAL, circa 1985

W-2 (Koreba) Class II - III Warp Shuttle

Known Sphere of Operation: Empire-wide use; the Triangle

Data Reliability: A

Major Data Source: All models in Star Fleet possession.

Of the 2,193 W-2s built, 1,087 As, 8 Cs, and 237 Fs remain in active service; 120 As and 16 Fs are used as training vessels; 567 have been destroyed; 46 have been captured, including 24 As and 2 Cs by Star Fleet, 13 As and 2 Fs by the Romulans, 3 As and 1 F by private interests in the Triangle, and 1 A by the Orions; 49 As and 3 Fs are listed as missing; 12 have been scrapped; and 48 have been sold or traded, including 27 As and 2 Fs to private interests in the Triangle, and 17 As and 4 Fs to the Orions. The W-2F is produced at the Taamar, Fonawl, Z'hai, and H'rez facilities at a combined rate of 60 per year; all other models are out of production. The class is named for a small rodent native to Klinzhal. This creature carries its young in pouches located along its back.

Construction Data:

Model Numbers-	A	C	F
Ship Class-	II	III	II
Date Entering Service-	1/9009	2/1102	2/1812
Number Constructed	863	50	280

Hull Data:

Superstructure Points-	4	8	4
Damage Chart-	C	C	C
Size			
Length-	84 meters	84 meters	84 meters
Width-	24 meters	24 meters	24 meters
Height-	17 meters	18 meters	18 meters
Weight-	14,300 tons	23,700 tons	14,500 tons
Cargo			
Cargo Units-	28 units	28 units	28 units
Cargo Capacity-	1,400 tons	1,400 tons	1,400 tons
Landing Capability-	Yes	Yes	Yes

Equipment Data:

Control Computer Type-	ZD-2	ZD-4	ZD-2
Transporters-			
Standard 6-person-	1	1	1
Combat 22-person-	none	none	none
Emergency 18-person-	none	none	none
cargo small-	none	none	none
cargo large-	none	none	none
Cloaking Device Type-	none	none	none
Power Requirement-	none	none	none

Other Data:

Crew-	13	13	13
Troops-	none	none	none
Passengers-	10	10	10
Shuttlecraft-	none	none	none

Engines and Power Data:

Total Power Units Available-	14	14	15
Movement Point Ratio-	1/1	2/1	1/1
Warp Engine Type-	KWB-2	KWB-2	KWB-2
Number-	1	1	1
Power Units Available-	12	12	12
Stress Charts-	O/P	O/P	O/P
Maximum Safe Cruising Speed-	Warp 6	Warp 5	Warp 6
Emergency Speed-	Warp 8	Warp 6	Warp 7
Impulse Engine Type-	KIA-2	KIA-2	KIA-3
Power Units Available-	2	2	3

Weapons and Firing Data:

Beam Weapon Type-	KD-1	KD-2	KD-3
Number-	2	2	2
Firing Arcs-	F	F	F
Firing Chart-	B	G	I
Maximum Power-	4	4	5
Damage Modifiers			
+3	-		
+2	-		
+1	-	(1 - 10)	(1 - 12)

Shields Data:

Deflector Shield Type-	KSC	KSD	KSE
Shield Point Ratio-	1/1	1/2	1/1
Maximum Shield Power-	11	13	12

Defense Factor-
Weapon Damage Factor-

41.2

52.4

55.2

1.4

2.8

5.4

[<<<< GO BACK](#)

IMPORTANT NOTE:

It is entirely possible that you have surfed to this page from an internet portal and are now viewing this page without frames. **The STSSTCSMU&A is best viewed from within its own set of frames**, so [click here to jump to the main STSSTCSMU&A web page](#) and then [see the site as it was meant to be seen!](#)

W-4 'SPEEDSTAR' CLASS SHUTTLE

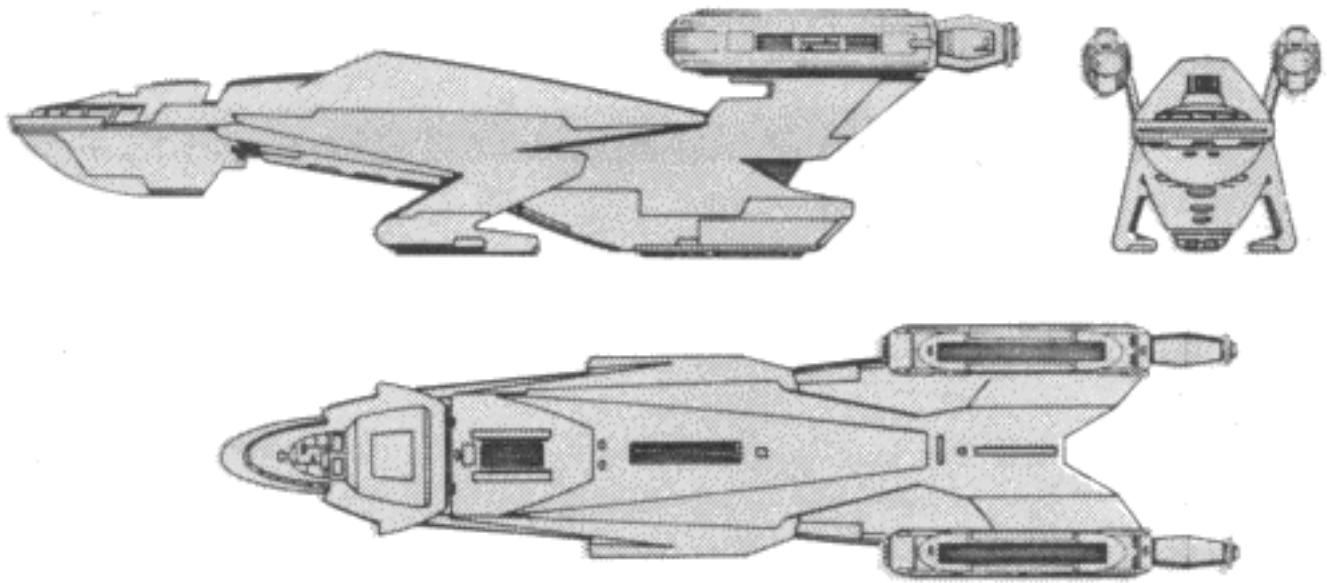

[Click here to view this class in its own window](#)

BRAD'S COMMENTS: Amazingly, the Klingon warp shuttles and tenders are all armed! Why arm these little guys and not the freighters? C'mon.



From the **FASA Star Trek KLINGON SHIP RECOGNITION MANUAL**, circa 1985

W-4 (Speedstar) Class III Warp Shuttle

Known Sphere of Operation: Empire-wide use; the Triangle

Data Reliability: A

Major Data Source: All models in Star Fleet possession

Of the 988 W-4s built, 437 As and 355 Bs remain in active service; 8 As and 4 Bs are used as training vessels; 113 have been destroyed; 15 have been captured, including 7 As and 1 B by Star Fleet, 3 As and 2 Bs by the Romulans, and 1 A and 1 B by private interests in the Triangle; 18 As and 7 Bs are listed as missing; and 31 have been traded or sold, including 16 As and 5 Bs to private interests in the Triangle, and 8 As and 2 Bs to the Orions. The W-4 is produced at the Taamar, Fonawl, and Z'hai facilities at a combined rate of 50 per year. The name is from the Klingon *kas maal*.

Construction Data:

Model Numbers-	A	B
Ship Class-	III	III
Date Entering Service-	2/1110	2/1504
Number Constructed	594	394

Hull Data:

Superstructure Points-	4	5
Damage Chart-	C	C
Size		
Length-	90 meters	90 meters
Width-	20 meters	20 meters
Height-	20 meters	20 meters
Weight-	21,100 tons	24,300 tons
Cargo		
Cargo Units-	30 units	30 units
Cargo Capacity-	1,500 tons	1,500 tons
Landing Capability-	Yes	Yes

Equipment Data:

Control Computer Type-	ZD-3	ZD-4
Transporters-		
Standard 6-person-	1	1
Combat 22-person-	none	none
Emergency 18-person-	none	none
cargo small-	1	1
cargo large-	none	none
Cloaking Device Type-	none	none
Power Requirement-	none	none

Other Data:

Crew-	10	10
Troops-	none	none
Passengers-	20	20
Shuttlecraft-	none	none

Engines and Power Data:

Total Power Units Available-	21	21
Movement Point Ratio-	1/1	1/1
Warp Engine Type-	KWB-1	KWB-1
Number-	2	2
Power Units Available-	9	9
Stress Charts-	O/Q	O/Q
Maximum Safe Cruising Speed-	Warp 7	Warp 7
Emergency Speed-	Warp 8	Warp 8
Impulse Engine Type-	KIB-1	KIB-1
Power Units Available-	3	3

Weapons and Firing Data:

Beam Weapon Type-	KD-10	KD-2
Number-	2	2
Firing Arcs-	1f/p, 1f/s	1f/p, 1f/s
Firing Chart-	C	G
Maximum Power-	3	4
Damage Modifiers		
+3		
+2		
+1	(1 - 6)	(1 - 10)

Shields Data:

Deflector Shield Type-	KSI	KSD
Shield Point Ratio-	1/1	1/1
Maximum Shield Power-	14	12

Defense Factor-
Weapon Damage Factor-

55.2 83.1
1.4 2.8

[<<<< GO BACK](#)

IMPORTANT NOTE:

It is entirely possible that you have surfed to this page from an internet portal and are now viewing this page without frames. **The STSSTCSMU&A is best viewed from within its own set of frames**, so [click here to jump to the main STSSTCSMU&A web page](#) and then [see the site as it was meant to be seen!](#)

G-3 'BAKA RE' CLASS FREIGHTER

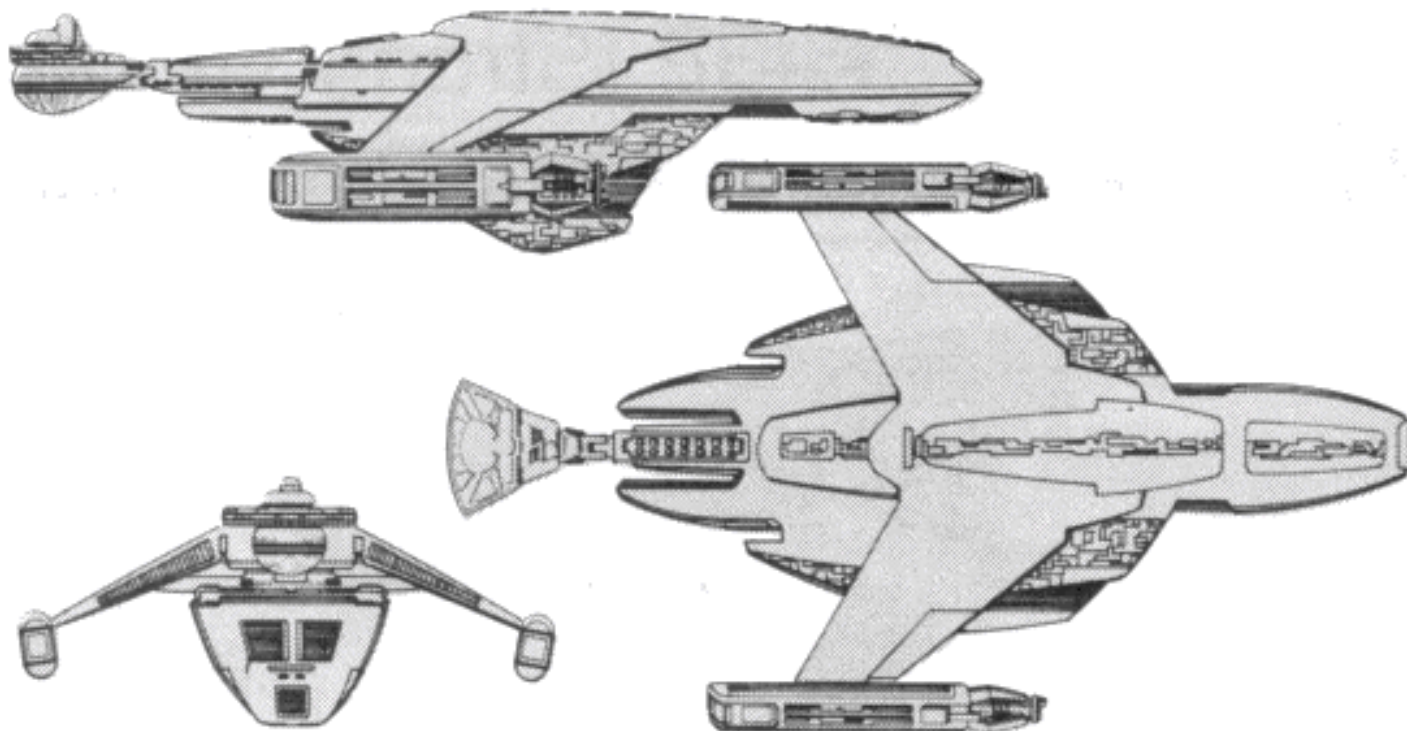

[Click here to view this ship in its own window](#)

BRAD'S COMMENTS: The aged B-52 had an affectionate nickname hung on it by its crews: B.U.F.F. The acronym being translated to mean Big Ugly Fat Fucker. I often think of that acronym when I see this design, even more than the ridiculous [L-13](#). But hey, the G-3 is a freighter after all, and freighters are not glamour ships like the cruisers. A freighter is a working man's vessel, and as with cargo ships of the 21st century, the cargo craft of the 23rd century are not known for their pleasing aesthetics; especially within Klingon territory! The G-3 is also notable in that it is one of the only Klingon ships that carries no weaponry.

From the FASA Star Trek KLINGON SHIP RECOGNITION MANUAL, circa 1985

G-3 (Baka Re) Class VII-VIII Freighter

Known Sphere Of Operation: Empire-wide use; the Triangle and Orion space.

Data Reliability: C

Major Data Source: Triangle Sector Intelligence, Orion Sector Intelligence

Of the 473 G-3 freighters built, 256 As and 167 Bs remain in active service, 28 As and 9 Bs have been destroyed, 3 As and 1 B are listed as missing, 1 of each has been scrapped, 2 As and 2 Bs have been traded to the Romulans, and 2 As and 1 B have been sold to the Orions. The G-3s are produced at Gnuu Re' and Mustaka, with a combined annual rate of 24. The class name is the Klingon word for "pregnant".

Construction Data:

Model Numbers-	A	B
Ship Class-	VII	VIII
Date Entering Service-	2/0406	2/1510
Number Constructed	292	181

Hull Data:

Superstructure Points-	9	10
Damage Chart-	B	B
Size		
Length-	240 meters	240 meters
Width-	140 meters	140 meters
Height-	60 meters	60 meters
Weight-	81,500 tons	113,100 tons
Cargo		
Cargo Units-	3,600 units	3,800 units
Cargo Capacity-	180,000 tons	190,000 tons
Landing Capability-	none	none

Equipment Data:

Control Computer Type-	ZD-5	ZD-5
Transporters-		
Standard 6-person-	1	1
Combat 22-person-	none	none
Emergency 18-person-	none	none
cargo small-	10	10
cargo large-	6	6
Cloaking Device Type-	None	None
Power Requirement-	None	None

Other Data:

Crew-	30	32
Troops-	none	none
Passengers-	10	10
Shuttlecraft-	6	6

Engines and Power Data:

Total Power Units Available-	40	40
Movement Point Ratio-	4/1	4/1
loaded-	6/1	7/1
Warp Engine Type-	KWD-1	KWE-2
Number-	2	2
Power Units Available-	18	18
Stress Charts-	L/N	J/M
Maximum Safe Cruising Speed-	Warp 6	Warp 7
loaded-	Warp 4	Warp 5
Emergency Speed-	Warp 8	Warp 8
loaded-	Warp 5	Warp 6
Impulse Engine Type-	KIC-2	KIC-2
Power Units Available-	4	4

Weapons and Firing Data:

	none	none
--	------	------

Shields Data:

Deflector Shield Type-	KSJ	KSN
Shield Point Ratio-	2/3	2/3
Maximum Shield Power-	13	14

Defense Factor-

	53.4	56.3
--	------	------

Weapon Damage Factor-

	0.0	0.0
--	-----	-----

[<<<< GO BACK](#)

IMPORTANT NOTE:

It is entirely possible that you have surfed to this page from an internet portal

and are now viewing this page without frames. **The STSSTCSMU&A is best viewed from within its own set of frames**, so [click here to jump to the main STSSTCSMU&A web page](#) and then [see the site as it was meant to be seen!](#)

G-8 'TRADERS GAME' CLASS FREIGHTER

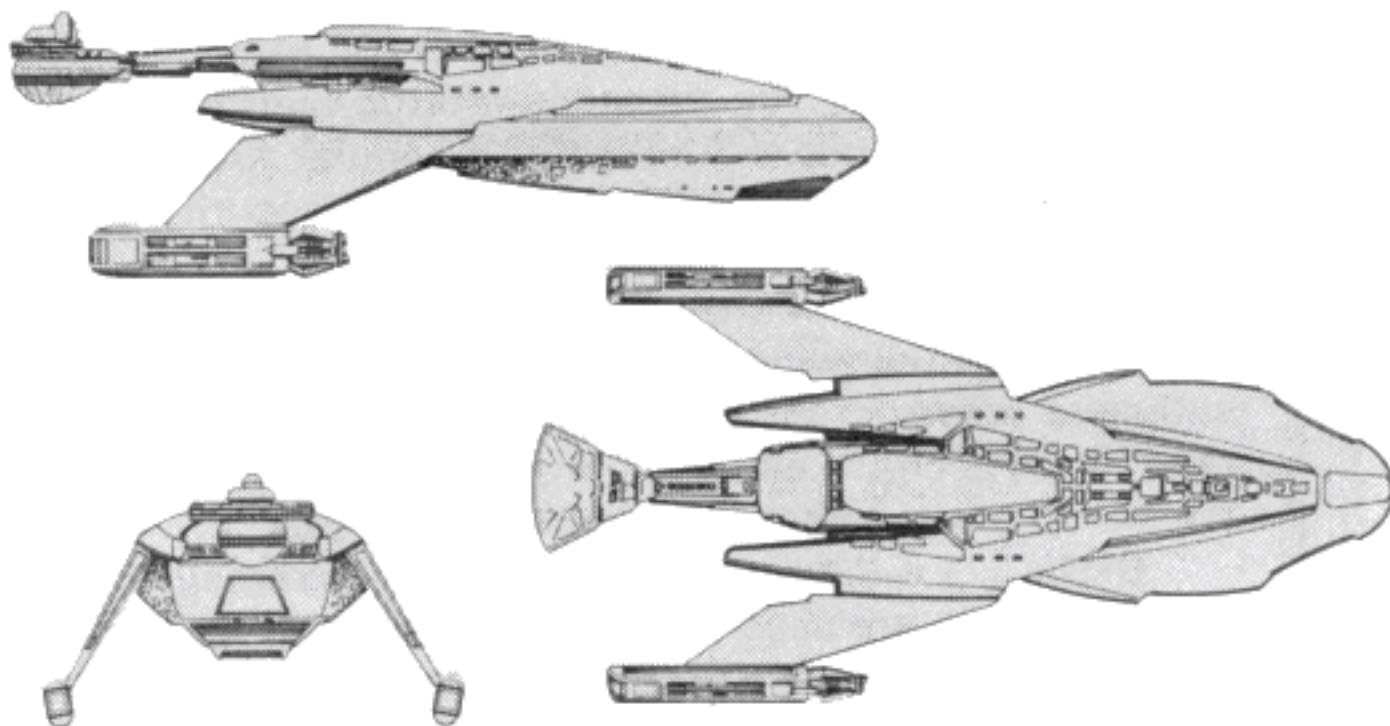

[Click here to view this ship in its own window](#)

BRAD'S COMMENTS: Another B.U.F.F. from the Klingons, though this time at least the thing has some teeth. Equipped with KD-1 disruptors, the G-8 can dish out a lethal 4 damage points per shot! Obviously any ship like this is not going to fare well in combat. Treat it as an accessory piece that is either the target of a scenario, or that must be defended in a scenario. (aka: Federation ships trying to intercept illegal Klingon arms shipments to worlds in the Neutral Zone, or something.)



From the FASA Star Trek KLINGON SHIP RECOGNITION MANUAL, circa 1985

G-8 (Traders Game) Class IV Freighter

Known Sphere of Operation: Empire-wide use; the Triangle and Orion space

Data Reliability: B

Major Data Source: Orion Sector Intelligence, Triangle Sector Intelligence

Of the 531 G-8s built, 308 remain in active service, 191 have been destroyed, 17 have been captured (6 by Star Fleet, 6 by Orions, and 5 by the Romulans), 8 are listed as missing, 5 have been scrapped, and 2 have been sold to private interests in the Triangle. The G-8s are being produced at Taamar, Fonawl, and Z'hai with a combined rate of 18 per year. The class name is from the Klingon *plen zha*, translates to "trader's game".

Construction Data:

Model Numbers-	A
Ship Class-	IV
Date Entering Service-	1/9501
Number Constructed	531

Hull Data:

Superstructure Points-	7
Damage Chart-	A
Size	
Length-	210 meters
Width-	100 meters
Height-	60 meters
Weight-	35,200 tons
Cargo	
Cargo Units-	2,300 units
Cargo Capacity-	115,000 tons
Landing Capability-	none

Equipment Data:

Control Computer Type-	ZD-4
Transporters-	
Standard 6-person-	1
Combat 22-person-	none
Emergency 18-person-	none
cargo small-	8
cargo large-	none
Cloaking Device Type-	none
Power Requirement-	none

Other Data:

Crew-	24
Troops-	none
Passengers-	6
Shuttlecraft-	4

Engines and Power Data:

Total Power Units Available-	29
Movement Point Ratio-	2/1
loaded-	6/1
Warp Engine Type-	KWB-3
Number-	2
Power Units Available-	13
Stress Charts-	O/Q
Maximum Safe Cruising Speed-	Warp 8
loaded-	Warp 4
Emergency Speed-	Warp 9
loaded-	Warp 5
Impulse Engine Type-	KIB-1
Power Units Available-	3

Weapons and Firing Data:

Beam Weapon Type-	KD-1
Number-	2
Firing Arcs-	1p/f/s, 1p/a/s
Firing Chart-	B
Maximum Power-	4
Damage Modifiers	
+3	-
+2	-
+1	-

Shields Data:

Deflector Shield Type-	KSE
Shield Point Ratio-	1/1
Maximum Shield Power-	11

Defense Factor-	46.1
------------------------	------

Weapon Damage Factor-	1.4
------------------------------	-----

[<<<< GO BACK](#)

IMPORTANT NOTE:

It is entirely possible that you have surfed to this page from an internet portal and are now viewing this page without frames. **The STSSTCSMU&A is best viewed from within its own set of frames**, so [click here to jump to the main STSSTCSMU&A web page](#) and then [see the site as it was meant to be seen!](#)

G-5 'TUGBOAT' CLASS TRANSPORT

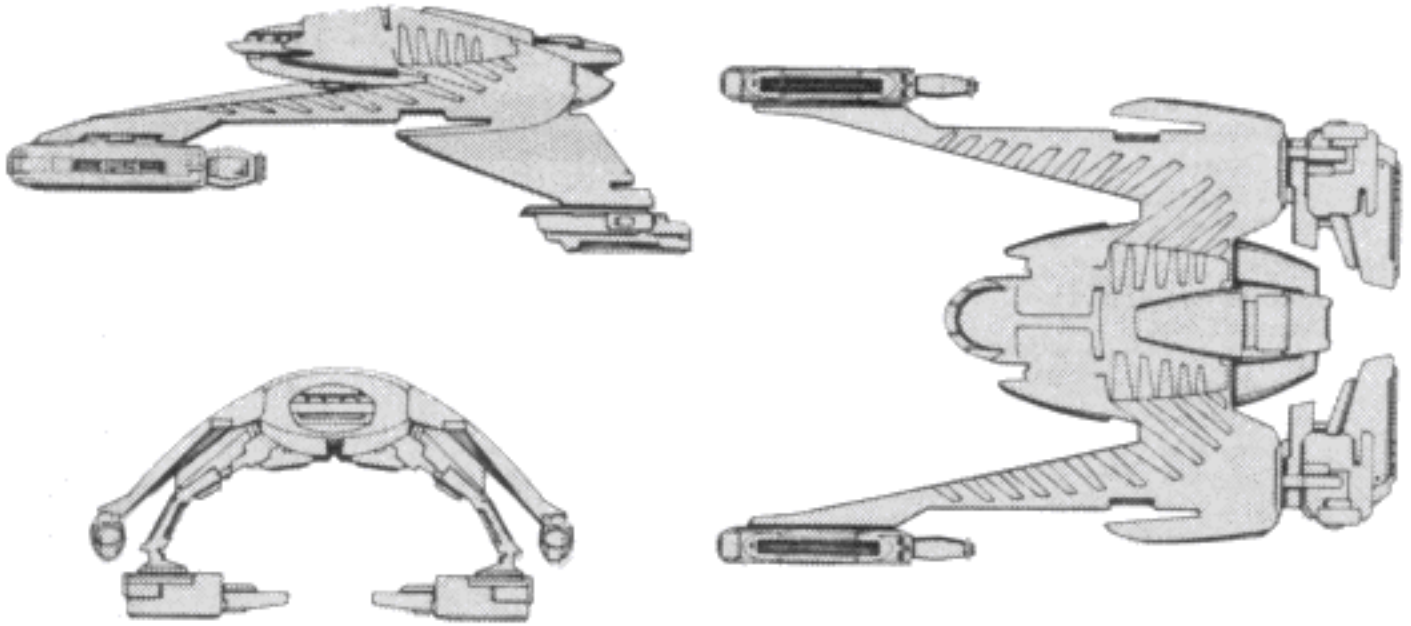

[Click here to see this ship in its own window](#)

BRAD'S COMMENTS: What good is an unarmed tugboat in the STSSTCS?! Heckiflknow! Window dressing, scenario accessory, et cetera. I have never bothered to play this class. It looks like it wouldn't last any longer in a melee than an ice cube on a black iron stove.



From the FASA Star Trek KLINGON SHIP RECOGNITION MANUAL, circa 1985

G-5 (Tugboat) Class VIII Cargo Transport

Known Sphere Of Operation: Empire-wide use; the Triangle

Data Reliability: B

Major Data Source: Klingon Sector intelligence, Triangle Sector Intelligence.

Of the 386 G-5s built, 338 remain in active service, 21 have been destroyed, 2 have been captured by private interests in the Triangle, 13 are listed as missing, 3 have been scrapped, and 12 have been traded to the Romulans. The G-5 is manufactured at the facilities of Gnuu Re' and Taamar. Annual production rate is 30. The name, an obvious reference to its function, is a translation of the Klingon *qexa*.

Construction Data:

Model Numbers-	A
Ship Class-	VIII
Date Entering Service-	2/1012
Number Constructed	386

Hull Data:

Superstructure Points-	12
Damage Chart-	A
Size	
Length-	110 meters
Width-	80 meters
Height-	40 meters
Weight-	102,900 tons
Cargo	
Cargo Capacity-	250,000 tons
Landing Capability-	none

Equipment Data:

Control Computer Type-	ZD-4
Transporters-	
Standard 6-person-	1

Other Data:

Crew-	20
Troops-	none
Passengers-	2
Shuttlecraft-	2

Engines and Power Data:

Total Power Units Available-	26
Movement Point Ratio-	3/1
loaded-	7/1
Warp Engine Type-	KWE-1
Number-	2
Power Units Available-	11
Stress Charts-	I/L
Maximum Safe Cruising Speed-	Warp 6
loaded-	Warp 4
Emergency Speed-	Warp 8
loaded-	Warp 5
Impulse Engine Type-	KID-2
Power Units Available-	4

Weapons and Firing Data:

none

Shields Data:

Deflector Shield Type-	KSG
Shield Point Ratio-	1/2
Maximum Shield Power-	9

Defense Factor-

54.2

Weapon Damage Factor-

0.0

[<<<< GO BACK](#)

IMPORTANT NOTE:

It is entirely possible that you have surfed to this page from an internet portal and are now viewing this page without frames. **The STSSTCSMU&A is best viewed from within its own set of frames**, so [click here to jump to the main STSSTCSMU&A web page](#) and then [see the site as it was meant to be seen!](#)

G-6 'CATAPULT' CLASS TRANSPORT

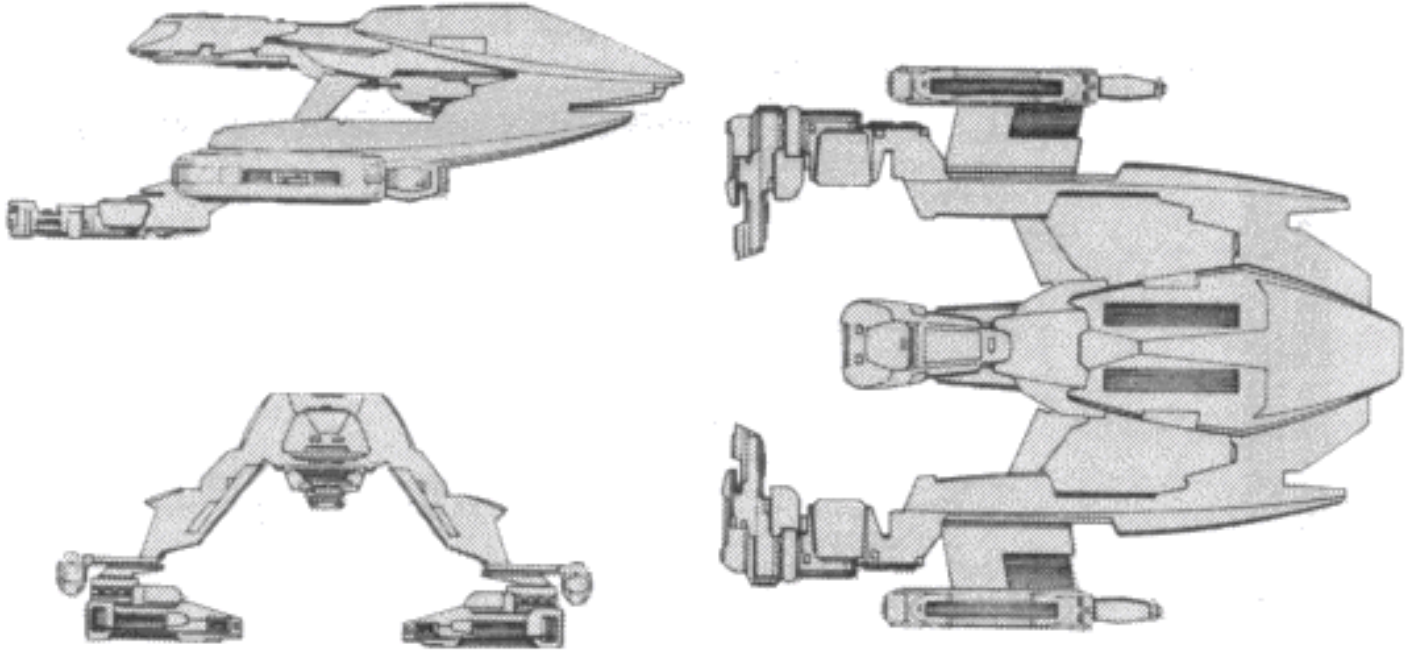

[Click here to view this ship in its own window](#)

BRAD'S COMMENTS: What good is an unarmed tugboat in the STSSTCS?! Heckiflknow! Window dressing, scenario accessory, et cetera. I have never bothered to play this class. It looks like it wouldn't last any longer in a melee than an ice cube on a black iron stove.



From the FASA Star Trek KLINGON SHIP RECOGNITION MANUAL, circa 1985

G-6 (Catapult) Class VIII Cargo Transport

Known Sphere Of Operation: Empire-wide use; the Triangle.

Data Reliability: C

Major Data Source: Klingon Sector Intelligence, Triangle Sector Intelligence.

Of the 252 G-6s built, 216 remain in active service, 17 have been destroyed, 7 are listed as missing, 2 have been scrapped, and 10 have been traded to the Romulans. The G-6 is being produced at Iosia and Gnuu Re' at a combined rate of 28 per year. The class name is from the Klingon *besz rate*, which translates as "throwing machine".

Construction Data:

Model Numbers-	A
Ship Class-	VIII
Date Entering Service-	2/1407
Number Constructed	252

Hull Data:

Superstructure Points-	10
Damage Chart-	B
Size	
Length-	120 meters
Width-	90 meters
Height-	40 meters
Weight-	115,800 tons
Cargo	
Cargo Capacity-	280,000 tons
Landing Capability-	none

Equipment Data:

Control Computer Type-	ZD-6
Transporters-	
Standard 6-person-	1
Cargo-	1

Other Data:

Crew-	22
Troops-	none
Passengers-	3
Shuttlecraft-	2

Engines and Power Data:

Total Power Units Available-	44
Movement Point Ratio-	3/1
loaded-	6/1
Warp Engine Type-	KWE-3
Number-	2
Power Units Available-	20
Stress Charts-	J/M
Maximum Safe Cruising Speed-	Warp 8
loaded-	Warp 5
Emergency Speed-	Warp 9
loaded-	Warp 6
Impulse Engine Type-	KID-2
Power Units Available-	4

Weapons and Firing Data: none

Shields Data:

Deflector Shield Type-	KSG
Shield Point Ratio-	1/2
Maximum Shield Power-	9

Defense Factor- 69.3

Weapon Damage Factor- 0.0

[<<<< GO BACK](#)

IMPORTANT NOTE:

It is entirely possible that you have surfed to this page from an internet portal and are now viewing this page without frames. **The STSSTCSMU&A is best viewed from within its own set of frames**, so [click here to jump to the main STSSTCSMU&A web page](#) and then [see the site as it was meant to be seen!](#)

S-4 'MENDER' CLASS TENDER

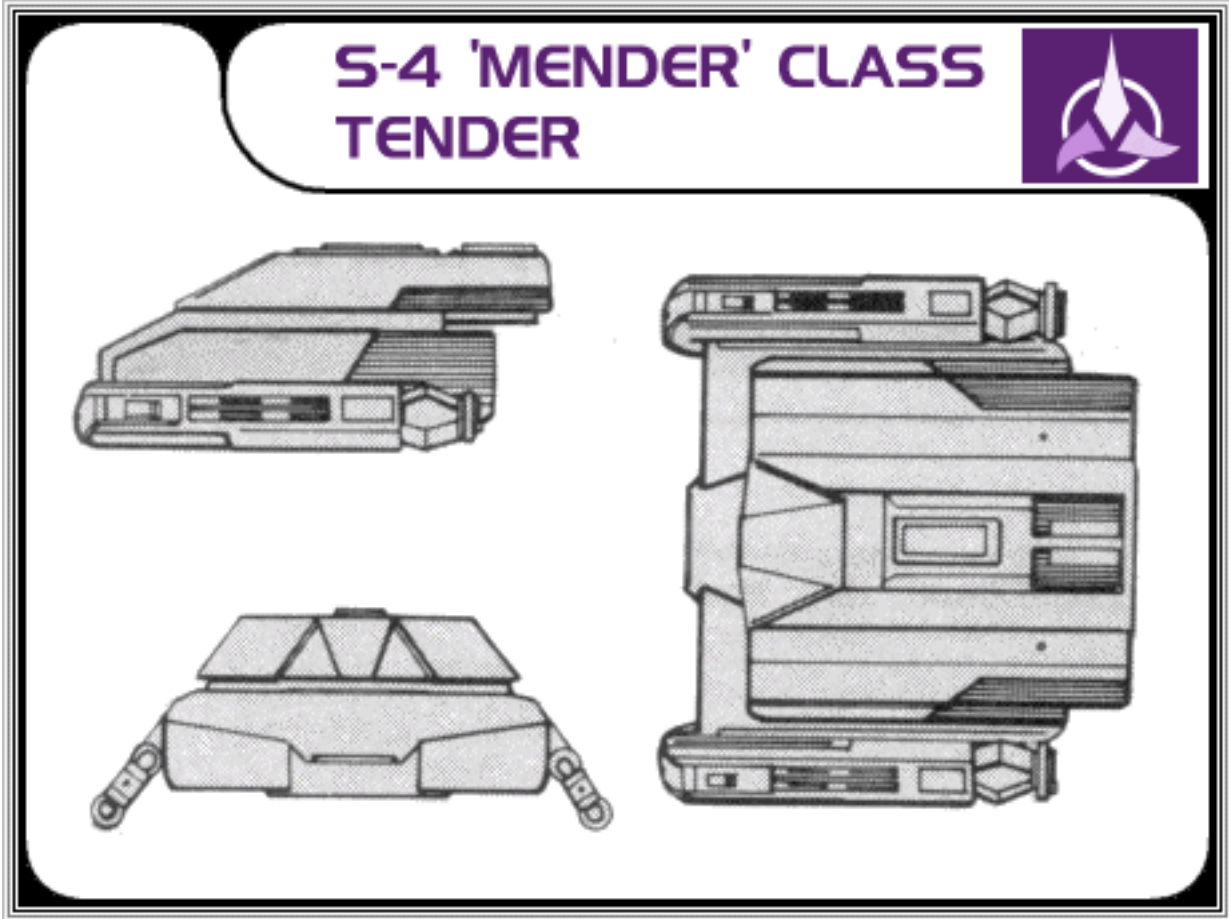

[Click here to view this ship in its own window](#)

BRAD'S COMMENTS: Amazingly, the Klingon warp shuttles and tenders are all armed! Why arm these little guys and not the freighters? C'mon.



From the FASA Star Trek KLINGON SHIP RECOGNITION MANUAL, circa 1985

S-4 (Mender) Class VI Repair Tender

Known Sphere of Operation: Empire-wide use, frequently operates in the Triangle

Data Reliability: A for S-4A; C for S-4B

Major Data Source: Model A in Star Fleet possession; Klingon Sector Intelligence

Of the 516 S-4s built, 431 remain in active service, 2 are used as training vessels, 29 have been destroyed, 5 have been captured (1 A and 2 Bs by Star Fleet, and 2 As and 1 B by private interests in the Triangle), 2 As and 1 B are listed as missing, 10 have been scrapped, and 21 have been sold or traded (6 As and 3 Bs to the Orions, 8 As and 3 Bs to private interests in the Triangle, and 1 A to the Romulans. The S-4 is being produced at the Taamar, Gnuu Re', and Mustaka facilities at a combined rate of 21 per year. All active S-4As have been converted to the B model. The name, a reference to its repair function, is from the Klingon *k'nall*.

Construction Data:

Model Numbers-	A	B
Ship Class-	VI	VI
Date Entering Service-	2/0607-2/2202	2/1801
Number Constructed	410	106

Hull Data:

Superstructure Points-	12	12
Damage Chart-	C	C
Size		
Length-	90 meters	90 meters
Width-	101 meters	101 meters
Height-	40 meters	40 meters
Weight-	76,600 tons	88,600 tons
Cargo		
Cargo Units-	110 units	110 units
Cargo Capacity-	5,500 tons	5,500 tons
Landing Capability-	Yes	Yes

Equipment Data:

Control Computer Type-	ZD-5	ZD-5
Transporters-		
Standard 6-person-	2	2
Combat 22-person-	none	none
Emergency 18-person-	none	none
cargo small-	1	1
cargo large-	none	none
Cloaking Device Type-	none	none
Power Requirement-	none	none

Other Data:

Crew-	108	115
Troops-	none	none
Passengers-	5	5
Shuttlecraft-	2	2

Engines and Power Data:

Total Power Units Available-	32	40
Movement Point Ratio-	3/1	4/1
Warp Engine Type-	KWC-1	KWD-1
Number-	2	2
Power Units Available-	14	18
Stress Charts-	L/O	L/N
Maximum Safe Cruising Speed-	Warp 7	Warp 6
Emergency Speed-	Warp 8	Warp 8
Impulse Engine Type-	KIC-2	KIC-2
Power Units Available-	4	4

Weapons and Firing Data:

Beam Weapon Type-	KD-1	KD-14
Number-	4	4
Firing Arcs-	1f/p, 1f/s, 1a/p, 1a/s	1f/p, 1f/s, 1a/p, 1a/s
Firing Chart-	B	D
Maximum Power-	4	8
Damage Modifiers		
+3		
+2		(1 - 6)
+1		

Shields Data:

Deflector Shield Type-	KSF	KSF
Shield Point Ratio-	2/3	2/3
Maximum Shield Power-	10	10

Defense Factor-
Weapon Damage Factor-

53.9
2.8

53.2
8.4

[<<<< GO BACK](#)

IMPORTANT NOTE:

It is entirely possible that you have surfed to this page from an internet portal and are now viewing this page without frames. **The STSSTCSMU&A is best viewed from within its own set of frames**, so [click here to jump to the main STSSTCSMU&A web page](#) and then [see the site as it was meant to be seen!](#)

S-5 'HEALER' CLASS TENDER

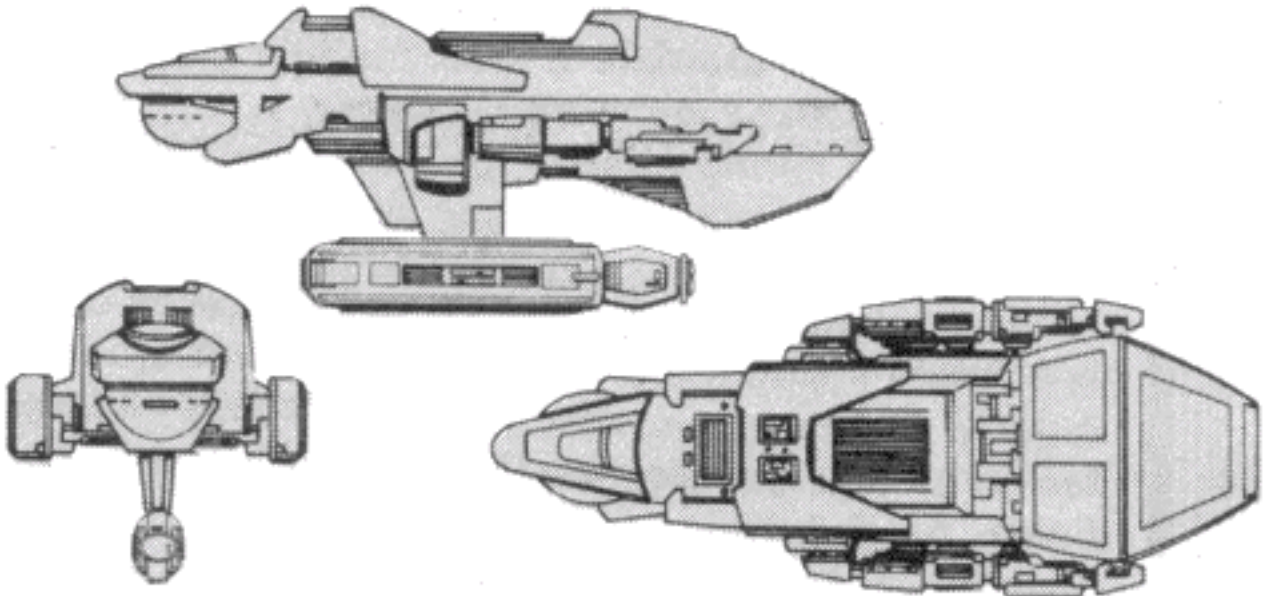

[Click here to view this class in its own window](#)

BRAD'S COMMENTS: Amazingly, the Klingon warp shuttles and tenders are all armed! Why arm these little guys and not the freighters? C'mon.



From the FASA Star Trek KLINGON SHIP RECOGNITION MANUAL, circa 1985

S-5 (Healer) Class IV Repair Tender

Known Sphere of Operation: All Border areas

Data Reliability: A

Major Data Source: Vessel in Star Fleet possession

Of the 262 S-5s built, 237 remain in active service, 2 are used as training vessels, 16 have been destroyed, 4 have been captured (2 by Star Fleet and 2 by the Romulans), 1 is listed as missing, 1 has been scrapped, and 1 has been sold to private interests in the Triangle. The S-5 is produced at the Gnuu Re' facility at a rate of 12 per year. The name is a reference to the duties of the vessel; the Klingon class name is *Eakin Knall*, which translates to "ear healer".

Construction Data:

Model Numbers-	A
Ship Class-	IV
Date Entering Service-	2/0412
Number Constructed	262

Hull Data:

Superstructure Points-	5
Damage Chart-	B
Size	
Length-	185 meters
Width-	70 meters
Height-	70 meters
Weight-	35,360 tons
Cargo	
Cargo Units-	300 units
Cargo Capacity-	15,000 tons
Landing Capability-	none

Equipment Data:

Control Computer Type-	ZD-3
Transporters-	
Standard 6-person-	2
Combat 22-person-	none
Emergency 18-person-	none
cargo small-	2
cargo large-	2
Cloaking Device Type-	none
Power Requirement-	none

Other Data:

Crew-	36
Troops-	none
Passengers-	none
Shuttlecraft-	10

Engines and Power Data:

Total Power Units Available-	17
Movement Point Ratio-	2/1
Warp Engine Type-	KWC-1
Number-	1
Power Units Available-	14
Stress Charts-	K/N
Maximum Safe Cruising Speed-	Warp 7
Emergency Speed-	Warp 8
Impulse Engine Type-	KIB-1
Power Units Available-	3

Weapons and Firing Data:

Beam Weapon Type-	KD-2
Number-	2
Firing Arcs-	2f/p/s
Firing Chart-	G
Maximum Power-	4
Damage Modifiers	
+3	
+2	
+1	(1 - 10)

Shields Data:

Deflector Shield Type-	KSI
Shield Point Ratio-	1/1
Maximum Shield Power-	14

Defense Factor-
Weapon Damage Factor-

39.1
2.8

[<<<< GO BACK](#)

IMPORTANT NOTE:

It is entirely possible that you have surfed to this page from an internet portal and are now viewing this page without frames. **The STSSTCSMU&A is best viewed from within its own set of frames**, so [click here to jump to the main STSSTCSMU&A web page](#) and then [see the site as it was meant to be seen!](#)

S-8 'MURPH' CLASS MOBILE REPAIR FACILITY

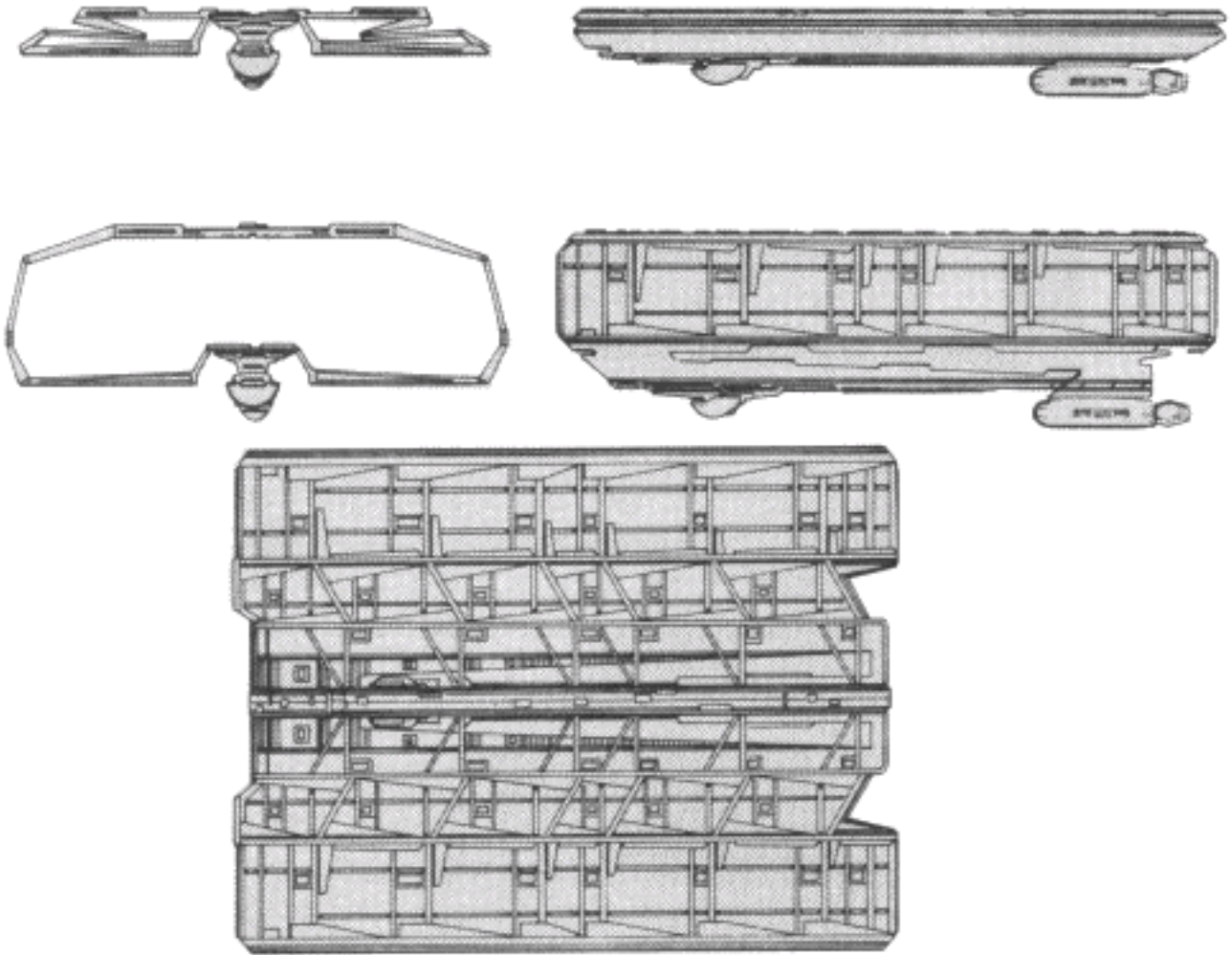

[Click here to view this ship in its own window](#)

BRAD'S COMMENTS: The Federation MRF and the Klingon MRF look very much alike, and both of these ships are basically mobile versions of the skeleton-like space docks seen in both **Star Trek TMP** and **Star Trek II**. I've been trying to work on some game rules that incorporate these types into scenarios much more effectively, but it is hard. A simplistic rule might be that if a damaged ship can reach a friendly MRF on the star map, then said ship can spend two or three turns out of action and come back into the fight good as new. This is hardly realistic however seeing as how even minor damage to a starship takes hours or even days to repair, and major damage might leave a ship in drydock for weeks, months, or total the craft beyond all repair. So for now, I don't ever play this vessel, nor do I play the Federation MRF. Maybe if I can play test some new rules I will add them to the site, but until then the MRF is not much more than another accessory piece incapable of defending itself or attack someone else. Even the gunboat escorts don't make a difference because gunboats are clay pigeons against most capital ships anyway.



From the **FASA Star Trek KLINGON SHIP RECOGNITION MANUAL**, circa 1985

S-8 (Murph) Class VI Mobile Repair Facility

Known Sphere of Operation: Empire-wide use, The Triangle

Data Reliability: C

Major Data Source: Klingon Sector Intelligence, Operation Dixie

The S-8 was the first mobile repair facility in known space. Lessons learned during the Four Years War, during which front-line repair of warships was inefficient, showed that faster repair capabilities were needed. The only way this could be accomplished was to take the facility to the area of conflict, and the Imperial Command constructed a vessel that would be capable of traveling with the fleets and performing any repairs. On Stardate 2/1208, the first S-8s were commissioned and sent to join various fleets.

The S-8 has two configurations, one for travel (shown in the accompanying three-quarter view) and one for operation (shown in the three views). After arriving at its destination, the S-8 unfolds into its operational mode and begins repairing damaged vessels. In most cases, the damaged ship is brought inside the S-8 so that all damage can be repaired quickly. Damaged vessels are arranged in and around the facility to take advantage of its structural cranes and tractor fields. An S-8 repairing several different ships at once will give the most peculiar readings on sensor scans.

When the MRFs were first commissioned, they were considered to be so unmaneuverable that mounting weapons was impractical. To avoid the shame of commanding an unarmed vessel, two to five gunboats are assigned to its protection and are under the command of the S-8s captain. The 8 model is armed with two disruptors, and recent intelligence reports indicate that the S-8As are modifying themselves to the S-8B configuration.

Of the 362 S-8s built, 74 As and 279 Bs remain in active service, 2 As are used as training vessels, 2 have been destroyed, 1 A is listed as missing, 3 have been scrapped, and 1 A has been sold to private interests in the Triangle. The S-8s are officially being produced at Iosia, but some have been manufactured by other S-8s.

The class name is from the abbreviation of the vessel type, MRF; the Klingon class name is *Hban Pav*, which translates to 'folding box'.

Construction Data:

Model Numbers-	A	B
Ship Class-	VI	VI
Date Entering Service-	2/1208	2/2003
Number Constructed	344	280

Hull Data:

Superstructure Points-	15	15
Damage Chart-	C	C
Size		
Length-	259 meters	259 meters
Width-	191 meters	191 meters
Height-	76 meters	76 meters
Weight-	75,500 tons	76,900 tons
Cargo		
Cargo Units-	100 units	200 units
Cargo Capacity-	5,000 tons	10,000 tons
Landing Capability-	none	none

Equipment Data:

Control Computer Type-	ZD-5	ZD-5
Transporters-		
Standard 6-person-	2	2
Combat 22-person-	none	none
Emergency 18-person-	1	1
cargo small-	2	2
cargo large-	none	none
Cloaking Device Type-	none	none
Power Requirement-	none	none

Other Data:

Crew-	142	166
Troops-	none	none
Passengers-	42	80
Shuttlecraft-	2	4

Engines and Power Data:

Total Power Units Available-	20	24
Movement Point Ratio-	4/1	3/1
Warp Engine Type-	KWE-2	KWE-3
Number-	1	1
Power Units Available-	16	20
Stress Charts-	I/M	L/M
Maximum Safe Cruising Speed-	Warp 6	Warp 7
Emergency Speed-	Warp 7	Warp 8
Impulse Engine Type-	KIC-2	KIC-2
Power Units Available-	4	4

Weapons and Firing Data:

Beam Weapon Type-		KD-12
Number-		2
Firing Arcs-		1f/p/s, 1a/p/s
Firing Chart-		H
Maximum Power-		9
Damage Modifiers		
+3		(1 - 3)
+2		(4 - 8)
+1		(9 - 10)

Shields Data:

Deflector Shield Type-	KSG	KSG
Shield Point Ratio-	1/2	1/2
Maximum Shield Power-	11	11

Defense Factor-	51.5	58.5
Weapon Damage Factor-	0.0	7.4

[<<<< GO BACK](#)

IMPORTANT NOTE:

It is entirely possible that you have surfed to this page from an internet portal and are now viewing this page without frames. **The STSSTCSMU&A is best viewed from within its own set of frames**, so [click here to jump to the main STSSTCSMU&A web page](#) and then [see the site as it was meant to be seen!](#)

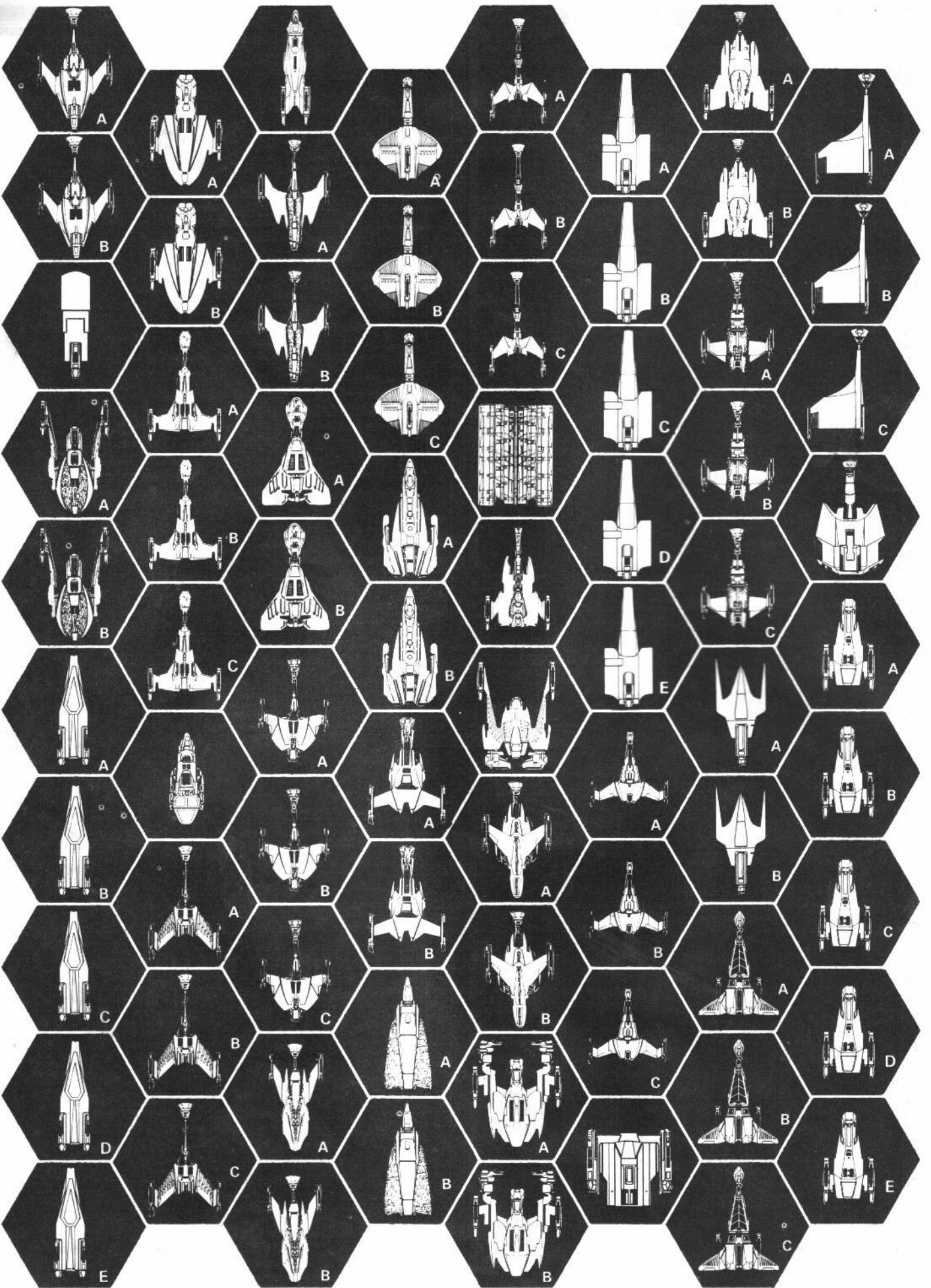

*These counters are to be used as playing pieces.
Glue onto cardboard and cut on solid white lines.*

CLASSIFIED AUTHORIZED PERSONNEL ONLY

The **Klingon Ship Recognition Manual** is intended for Star Fleet personnel with a "need to know" concerning information on the Imperial Klingon Navy. This comprehensive study discloses, for the first time, all known combat, visual, and historical data on 42 different Klingon ships and their variants. Also included is a chronology of service and silhouette recognition chart. This manual is a must for all *Star Trek* enthusiasts.

Shown on the cover is a cutaway view of the D-20 (Death Rite) class cruiser.

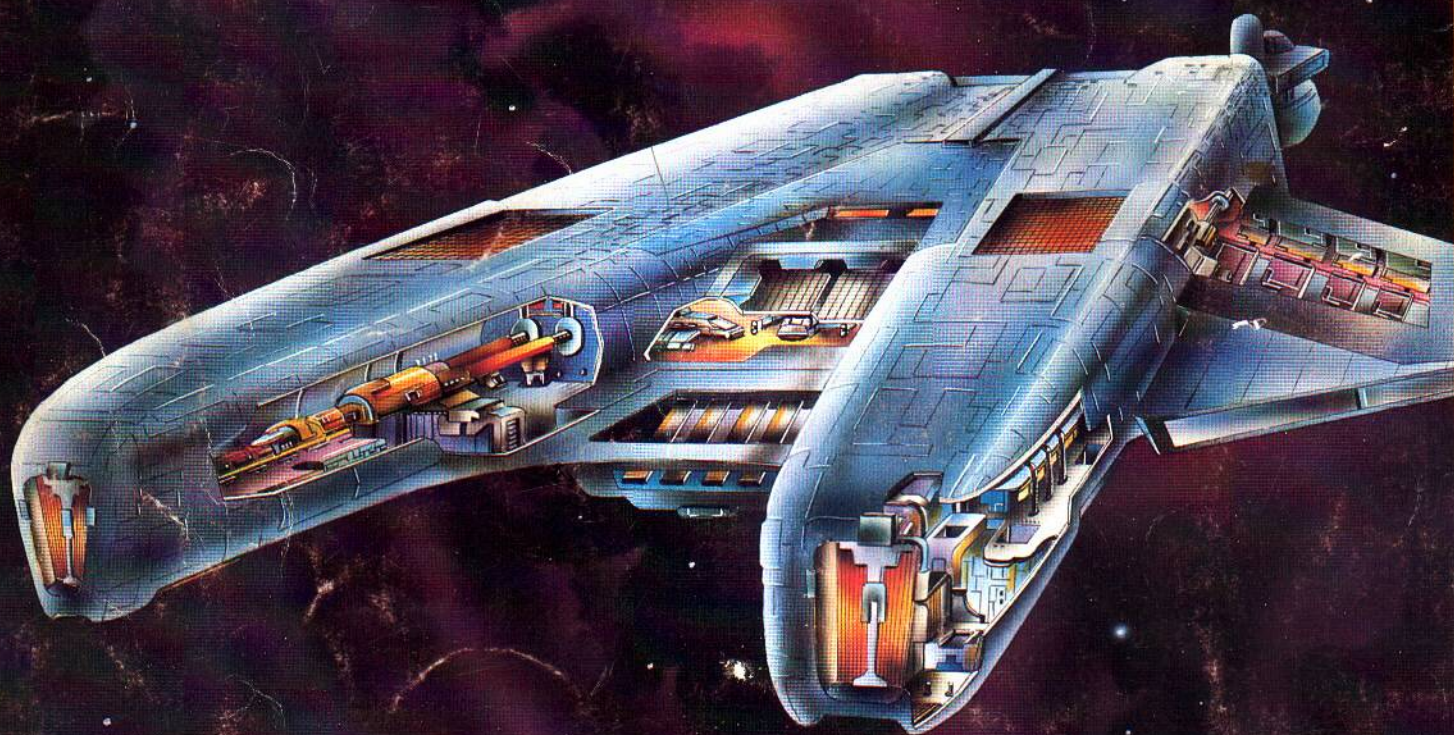

STAR TREK is a trademark of Paramount Pictures Corporation.
Copyright 1985 Paramount Pictures Corporation
All Rights Reserved
Printed in the United States of America



ISBN 0-931787-41-6 FASA700