

THE BEST OF  
**DOCKYARD REVIEW**  
VOLUME TWO: 2350-2390

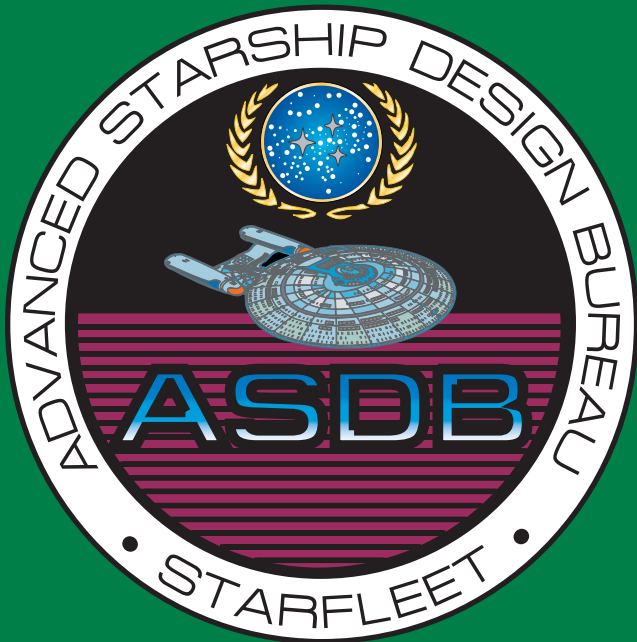

*A collection of selected articles  
Published by the Star Fleet Advanced Starship Design Bureau*

# **THE BEST OF DOCKYARD REVIEW**

## **VOLUME TWO: 2350-2390**

By Admiral Chris Wallace

# Masthead

## **CHIEF EDITOR AND PUBLISHER**

Admiral Chris Wallace  
Chief of Star Fleet Operations

## **LAYOUT CONSULTANT**

Sakura Shinguji  
Panda Press Interstellar

## **PROJECT COORDINATOR**

Captain Belldandy Morisato  
Star Fleet Advanced Starship Design Bureau

## **STRATEGIC EDITOR**

Commander Natsumi Tsujimoto  
Star Fleet Operating Forces

## **PRODUCTION EDITOR**

Rear Admiral Kurt Roithinger  
Star Fleet Command

## **TECHNICAL EDITOR**

Admiral Alex Rosenzweig  
Star Fleet Department of Technical Services

## **ENGINEERING CONSULTANT**

Lieutenant Commander Skuld  
Star Fleet Operating Forces

## **SYSTEMS ANALYST**

Rear Admiral Carsten Pedersen  
Star Fleet Office of Research and Development

## **NAVAL LIASON**

Rear Admiral John Scharmen  
Star Fleet Operations

## **GRAPHICS**

Commodore David Pipgras  
Region Five Office of Graphic Design

## **HISTORICAL CONSULTANT**

Lieutenant General Scott A. Akers  
Office of the Star Fleet Historian

## **SUPPORT STAFF**

Doctor Richard Sternbach, PhD.  
Doctor Michael Okuda, PhD.  
Doctor Graham Kennedy, PhD.  
Doctor Bernd Schneider, PhD.

Copyright © 2378 by the Star Fleet Spacecraft Design Advisory Commission, Star Fleet Command, Utopia Planitia Spacedock, Mars.

This document prepared and published by Team Neko and Team Kempo for the Starfleet Spacecraft Design Advisory Commission.

Memory Alpha Cataloging Data:  
UFPI ITP/SP SOTSF23772378

This edition of [Ships of the Star Fleet](#) is authorized for viewing only in member star systems of the United Federation of Planets, its territories and possessions, affiliated star systems, and select independent or neutral star systems.

This document and its entire contents Copyright © 2003 Panda Productions.

All rights reserved. We request that no part of this document be reproduced in any form or by any means, or stored on any electronic server (ftp or http) without the written permission of the publishers. Permission to make on printout for personal use is granted.

This book follows the form and layout of the [Ships of the Star Fleet](#) books published by Mastercom Data Center. Though inspired by those works, this work is not intended to be a copyright infringement of them. It is produced purely for informational and recreational purposes on a not-for-sale, not-for-profit, free-distribution basis.

This document includes schematics, data, and images from Paramount Pictures, Mateen Greenway, Scifi-Art.com, the WolfPack, and other sources. Where possible, permission has been obtained to use them in this document. Any display of copyrighted material in the document is not intended as an infringement of the rights of any of the copyright holders.

This is a publication of Panda Productions, Post Office Box 52663, Bellevue, Washington, 98015-2663.

Created and published in the United States of America.

# CONTENTS

01 Preface

## **Technology Articles**

02 The Deep Space Series

03 Cloaking Devices in Star Fleet

04 Is The Galaxy Class A Failure?

05 Why Two Nacelles Are Better Than Three

06 The FCE-2 Cloaking Device

07 Klingon Vessels in Star Fleet?

## **Starship Articles**

08 The Peacekeeper Class Diplomatic Cruiser

09 Starlight

10 The Flynt Class Battlecruiser

11 The U.S.S. Jaguar

12 Starblade

## **Appendix**

13 About the Publishing Team

14 Credits

15 Art Credits

16 Author's Notes

# **PREFACE**

# **THE BEST OF DOCKYARD REVIEW**

# **TECHNOLOGY ARTICLES**





# THE DEEP SPACE SERIES

## A NEW TWIST ON SPACE STATION DESIGN AND PROCUREMENT

**CAPTAIN YUMI KANDA**  
**CHAIRWOMAN - DEEP SPACE SERIES ADVISORY PANEL**  
**COMMANDING OFFICER - DEEP SPACE FOUR**  
**OCTOBER 2371 ISSUE**

“Deep Space” stations have been a part of the Federation for over one hundred years, going back to the old K-7 series seeded about Federation space. Designed around a commercial as opposed to military / political purpose like Starbases, the Deep Space series proved to be a cost-effective administrative and support platform, as well as a booster of trade and commerce.

However, as popular as they have been, Star Fleet could not afford to put them everywhere. As such, a number of star systems have taken it upon themselves to build their own “Deep Space” station and offer it’s services to the Star Fleet on a long-term lease basis.

Each of the nine current Deep Space stations are located on the outer rim of Federation space in areas where Star Fleet felt the expenditure to construct a “traditional” space station was not justified. All were designed, developed, and constructed by the local inhabitants to increase trade between their systems and the Federation itself. The one exception to this is the latest addition, Deep Space Nine. Located in the Bajoran system, DS9 was built by the Cardassian Union with local slave labor during their occupation of the Bajoran system.

Each space station (with the exception of DS9) is a showcase of the local architecture of the system, and are therefore unique in their design. All are owned locally, but they are administered by Star Fleet personnel and assigned registry numbers. They carry average armament and defensive systems, consistent with their roles as “waystations” for independent and Star Fleet traffic in the area.

The advantage of low operating costs has made the “Deep Space” concept an intriguing one for Star Fleet. Other systems, seeing the advantages gained by the nine systems that currently host “Deep Space” stations, are actively investigating undertaking such ventures for themselves.

---

**Captain Kanda serves as the Chairwoman of the Deep Space Advisory Board, which oversees the administration of the nine current Deep Space Stations. She also serves as the Commanding Officer of Deep Space Four.**





# CLOAKING DEVICES IN STAR FLEET

## A TREATISE ON THE FCE-2 AND ITS USE

REAR ADMIRAL CHRIS WALLACE  
CHAIRMAN - STAR FLEET ADVANCED STARSHIP DESIGN BUREAU  
COMMANDING OFFICER - STARSHIP U.S.S. BRIGHT STAR • NCC-71875  
OCTOBER 2371 ISSUE

When the design parameters of the *Galaxy (III)* class Starship Development Project were being laid out, one of the areas of emphasis was on the tactical systems of the class. Though on paper the *Galaxy* class mounts an impressive tactical array, in application the vessels of this class have been found lacking — even against starships many times their inferior.

It is an unfortunate comment on the state of intergalactic affairs that weapons research in the Federation continues to advance. The “fruits” of these labors were examined and then implemented into the *Galaxy (III)* class to make it better able to defend itself against Threat forces they may encounter.

One of the more hotly debated upgrades, both within the Federation and her interstellar neighbors, has been the implementation of the FCE-2 cloaking device as part of the FSS shield system upgrade.

As by its model designation, this is the second type of cloaking device used by the Federation, replacing the FCE-1 model used by many Star Fleet vessels in the late 2200's. These devices were disallowed under the Treaty of Algeron with the Romulan Empire, partly due to the fact it was developed using technologies from Romulan and Klingon devices stolen by James T. Kirk, and were removed from service as the vessels were retired or refit.

Though the Treaty prevented the Star Fleet from actually fielding a device, research continued

(both official and unofficial), though the designs never left the laboratory. An exception to this was the FCE-3 phased-cloaking device, which was tested illegally aboard the U.S.S. *Pegasus*, but a problem with the device resulted in the loss of the ship and most of the crew. Further research on the FCE-3 was cancelled.

With the discovery of new, more powerful Threat forces (the Borg and Dominion), and the instability of the Klingon and Romulan Star Empires, the decision was made to prepare a new cloaking device for possible future integration into Star Fleet vessels. In an effort to limit the “threat” factor such a device might cause amongst the Federation's neighbors, the decision was made to make it part of the shielding system. The FSS shield system, under development at the same time, was chosen as the system to use. This prevented weapons to be fired through the field without disrupting it, making the cloaking device useless as a strategic “first-strike” weapon. As it also reduces shield effectiveness by 60%, a cloaking device adds little, if anything, to the defensive aspects of the ship it is installed on in a combat situation.

So why build a cloaking device? While of limited use as a weapon, the cloaking device allows a great deal of flexibility to the more traditional mission of Star Fleet — exploration. When exploring civilizations not yet ready for first-contact, yet possessing sensor systems sophisticated enough to detect Federation vessels, the cloaking device would allow them to observe without being observed. And while there is a valid point to be made about their use in espionage-related matters against other governments, let's just say this allows us to “even the field” in that area.

Laboratory trials were successful and, befitting her status as the Star Fleet's "testbed" vessel, the *Galaxy (II)* class was chosen to test the design. Currently, as per Star Fleet protocol, only the lead vessel of the class, U.S.S. *Bright Star* (CKE 71875) was fitted with the FSS/FCE-2 system. Any future vessels of this class will, for the moment, use the FSQ/2 system which does not mount the FCE-2. Adding the two vessels of the *Griffon* class exploration battleship (U.S.S. *Griffon* and U.S.S. *Pendragon*) that also mount the FSS/FCE-2 system, that makes only three Ships of the Line with the system out of the thousands currently in service.

And though there are no plans to do so, studies are underway to allow the FSQ-series of shielding systems used by most current Federation starship compatible with the FCE-2 design, should such a need for this capability arise. This should serve notice to other governments that, while the Federation takes her Treaty requirements seriously and treats them with respect, we will not be bullied.

Any questions regarding current disposition of cloak-equipped vessels should be directed to the Department of Technical Services, care of Star Fleet Headquarters.

---

**Admiral Wallace is the Director of the Star Fleet Department of Technical Services and Chairman of the Advanced Starship Design Bureau. He also serves as the Executive Director of the *Galaxy* and *Galaxy (II)* Class Starship Development Projects and is the Commanding Officer of the *Galaxy (II)* class U.S.S. *Bright Star*.**



# IS THE GALAXY CLASS A FAILURE? DO DESIGN FLAWS MAR STAR FLEET'S FINEST EXPLORER?

REAR ADMIRAL CHRIS WALLACE  
CHAIRMAN - STAR FLEET ADVANCED STARSHIP DESIGN BUREAU  
COMMANDING OFFICER - STARSHIP U.S.S. BRIGHT STAR • NCC-71875  
JANUARY 2372 ISSUE

**(Note - This article includes information from the Board of Review on the loss of U.S.S. *Enterprise* • NCC-1701-D at Veridian III, chaired by Vice Admiral Alex Rosenzweig)**

Is the *Galaxy* class large exploratory cruiser — the pride of the Starfleet — a failure? Has the Federation spent hundreds of trillions of credits on a class of vessels that suffer from one, if not more, serious and possibly catastrophic design flaws? And are these vessels so complex that even Starfleet crews are unable to properly man them?

The *Galaxy* class Starship Development Project, of which I was named head of in 2355, was commissioned in 2343 to develop a new class of multi-mission starships capable of performing a wide range of duties, including exploration, military, diplomatic, and colonization, in the tradition of the *Constitution* and *Enterprise* classes. This class was to be the flagship of the late 24<sup>th</sup> Century fleet and the design goals and mission objectives were suitably ambitious. The final result was a titanic vessel costing tens of trillions of credits and showcasing the latest in Federation technologies and designed to last over a hundred years in service.

The lead vessel, U.S.S. *Galaxy* (CKE 70637) entered service in 2357, followed over the next five years by *Yamato* (CKE 71807), *Enterprise* (CKE 1701-D), *Challenger* (CKE 71099), *Odyssey* (CKE 71832), and *Venture* (CKE 71854). Six additional hulls were taken to the spaceframe stage before work was halted. This was to allow the six operational hulls to be “debugged” in service, with any

changes or upgrades that might be found to be necessary could be added to the later vessels, along with general advancements in technology.

Now, less than fifteen years after *Galaxy's* commissioning, she is only one of the three original ships to remain in service. *Yamato* was lost due to a complete system failure brought about by an alien computer virus from the Iconian homeworld. *Odyssey* was destroyed in combat with the Dominion, and the *Enterprise* was destroyed in combat with a Klingon D-22. Though the circumstances varied between the three vessels, the cause of the loss of each vessel could be traced to the warp drive system. In the case of *Yamato*, the virus destroyed the computer systems, resulting in the failure of the containment fields in the anti-matter storage bottles. The resulting release destroyed the ship with all hands. With *Odyssey*, she was rammed in the engineering hull by a Jem Hadar attack ship, resulting in a warp core breach.

But the most serious loss is that of the *Enterprise*. It appears that it was through what some describe as incompetence on the part of her crew, the vessel was lost. Based on pure statistics, the D-22 was no match whatsoever for a *Galaxy* class starship. Even though the Klingons were able to acquire the shield harmonics frequency, allowing them to get off two clean shots, reaction times of the crew were slowed by the complexity of the system. This resulted in ineffectual return fire and the inability to readjust the shield harmonics fast enough to prevent critical damage to the ship's systems. Bypassing these damaged systems also slowed the response time. This class, with so much cutting edge technology (some would say *bleeding edge* due to the untested

nature of so many of them), is far more complicated than her forebears. Even with the extensive computerization and automation, the ship is easily the most complicated ever commissioned.

In numerous incidents, it has been shown that the tactical capabilities of the *Galaxy* class are woefully overrated. Though they mount an extensive weapons and shield suite, lesser vessels have time and time again outmatched them. Though never designed as a gunboat, they were nonetheless expected to be the forefront of Starfleet's force and to be strong enough to operate independently on the frontier. It is hoped that the tactical improvements to the *Galaxy (II)* class will help strengthen her offensive abilities.

Another area where the class has been criticized is, ironically, one of those considered her strengths — her capability as an Explorer. Mounting the largest and most advanced sensor and laboratory suites ever placed on a Federation starship, these systems require enormous power to run and truly phenomenal computing capability to be used to their maximum potential. And even then, there are a myriad of scheduling and equipment conflicts that need to be addressed by the ship's Operations Officer. Having all this handled by three people is, at best, a severe strain on the personnel. Only the *Enterprise* enjoyed an artificial lifeform capable of juggling all these requests and data with ease. The remaining ships had to make do with "normal" lifeforms with all their frailties and faults. The combination of all this, at times, limits the effectiveness of these vessels in the performance of their missions, especially against dedicated science and scout vessels such as the *Oberth* and *Intrepid* classes.

So, is the *Galaxy* class a failure? Based on the fact that three vessels have been lost in less than ten years, one could argue the case. However, with a vessel of such complexity and grandiose mission objectives, and that all have been called upon to serve in harm's path, these losses, while tragic, are not endemic of any design flaw or failure.

In the end, it is felt by many in Starfleet that while the *Galaxy* class aspires to follow her heavy-cruiser forebears as a highly-effective multi-mission vehicle, the system complexities and weaknesses result in a "Jack of all trades, Master of none"-type vessel. In other words, a ship that can do a great many things, but none of them very well. This is in stark contrast to such vessels as the *Constitution* and *Enterprise* classes, which were the workhorses of their fleets.

As for myself, I feel that the *Galaxy* class is the most ambitious starship project ever conceived by the Federation. Designed in an area of unparalleled peace and prosperity, she was the manifestation of the dreams and hopes of her generation. The ship remains the most capable Explorer in the inventory, able to travel far distances at great speeds and has added immensely to our stores of knowledge about the universe. She has served with distinction as an ambassador for the Federation to both established worlds and first contact missions. She has her flaws, but future versions (like the *Galaxy (II)* and *Skylark* classes) are addressing these, resulting in making Starfleet's best that much better. As the largest ship in the Fleet, the *Galaxy* class have been called upon time and time again to perform duties that they were not truly expected, nor designed, to do.

The Veridian III Review Board recommended a number of courses of action. The first was to

explore smaller, more specialized classes of starship (such as the *Intrepid*) to perform some of the lesser tasks now assigned to *Galaxy* class vessels, freeing the larger ships to perform the roles they were designed to. The second was to recommend a revised and enhanced training program for all officers, crew, and civilians serving aboard *Galaxy* class vessels to improve crew efficiency and prevent a recurrence of the problems that felled the *Enterprise*.

---

**Admiral Wallace is the Director of the Starfleet Department of Technical Services and Chairman of the Advanced Starship Design Bureau. He also serves as the Executive Director of the *Galaxy* and *Galaxy (II)* Class Starship Development Projects and is the Commanding Officer of the *Galaxy (II)* class U.S.S. *Bright Star*.**



# WHY TWO NACELLES ARE BETTER THAN THREE

## A TREATISE ON WARP GEOMETRY

REAR ADMIRAL ADRIAN NEWEY  
DIRECTOR - STAR FLEET SPACECRAFT DESIGN ADVISORY COMMISSION  
OCTOBER 2372 ISSUE

For most of its history, Star Fleet vessels have been fitted with two warp nacelles, with single nacelles being much less common. Certain "heavy" vessels, mainly the dreadnoughts, have employed three nacelles, and we have even seen some four-nacelle designs over the past century. Why do Federation starship designers seem "stuck" on two nacelles? It all comes down to efficiency.

A common misconception amongst laymen is that the nacelles generate power. In fact, the nacelles use the power to generate the warp field that propels the ship. However, having additional nacelles does allow a larger M/AM reactor to be fitted, so the vessel does in fact produce more power.

A vessel with two nacelles produces 50% more power while consuming only 25% more reactants than a vessel with a single nacelle. Two nacelles also optimize vehicle control. By altering the timing differences of each nacelle, the warp field geometry can be varied on the X/Y-axis's, thereby altering the ship's heading. Single nacelle vessels require advanced field-control systems to perform these maneuvers, and only the smallest ships (such as scouts) use a single nacelle, since the cost of the control system is smaller than using two nacelles. Still, this is a rare case, and by the early 2300's, most single-nacelle designs were retired.

After the Romulan and Klingon wars, Star Fleet began development of the dreadnought class of starships to provide a high-speed weapons platform. To reduce costs and speed introduction,

Star Fleet decided to modify the *Constitution* class heavy cruiser rather than designing an entire new class of vessels. Additional phaser emplacements were added and, to increase speed, a third PB-31 warp nacelle was grafted to the top of the primary hull. And thus the *Federation* class dreadnought was born. Though the addition of the third nacelle required extensive modification to the impulse engines and required the moving of Main Engineering from that location to its present location in the secondary hull, it did raise the top speed of the vessel by two full warp factors. Total ship's power increased 50%, but the consumption rate of reactants doubled. The ship's handling characteristics were worsened, but this was deemed acceptable as the mission objectives were to keep the ship docked at Starbase until the start of hostilities. The dreadnought would then deploy to the trouble spot and engage the enemy forces in conjunction with smaller, more maneuverable vessels, acting as a "gun platform". These vessels never saw their intended service, but their deterrent effect probably helped contribute to that.

With the introduction of new and improved starship designs by the Klingon and Romulan Empires, Star Fleet decided to uprate the *Federation* class dreadnoughts to the technology and systems employed on the new *Enterprise* class of heavy cruisers. The dorsal section was lengthened to better integrate the LN-64 nacelle mounted there, without sacrificing impulse design or efficiency. The original mounting design of the side-mounted LN-64 nacelles was the same as that for the *Enterprise* class, but this was scrapped when the shaft design was found to interfere with the expanded hangar bay. A new design, with the shafts mounted flush to the top of the secondary hull and with a direct horizontal feed from one nacelle to the other. An

# WARP NACELLES

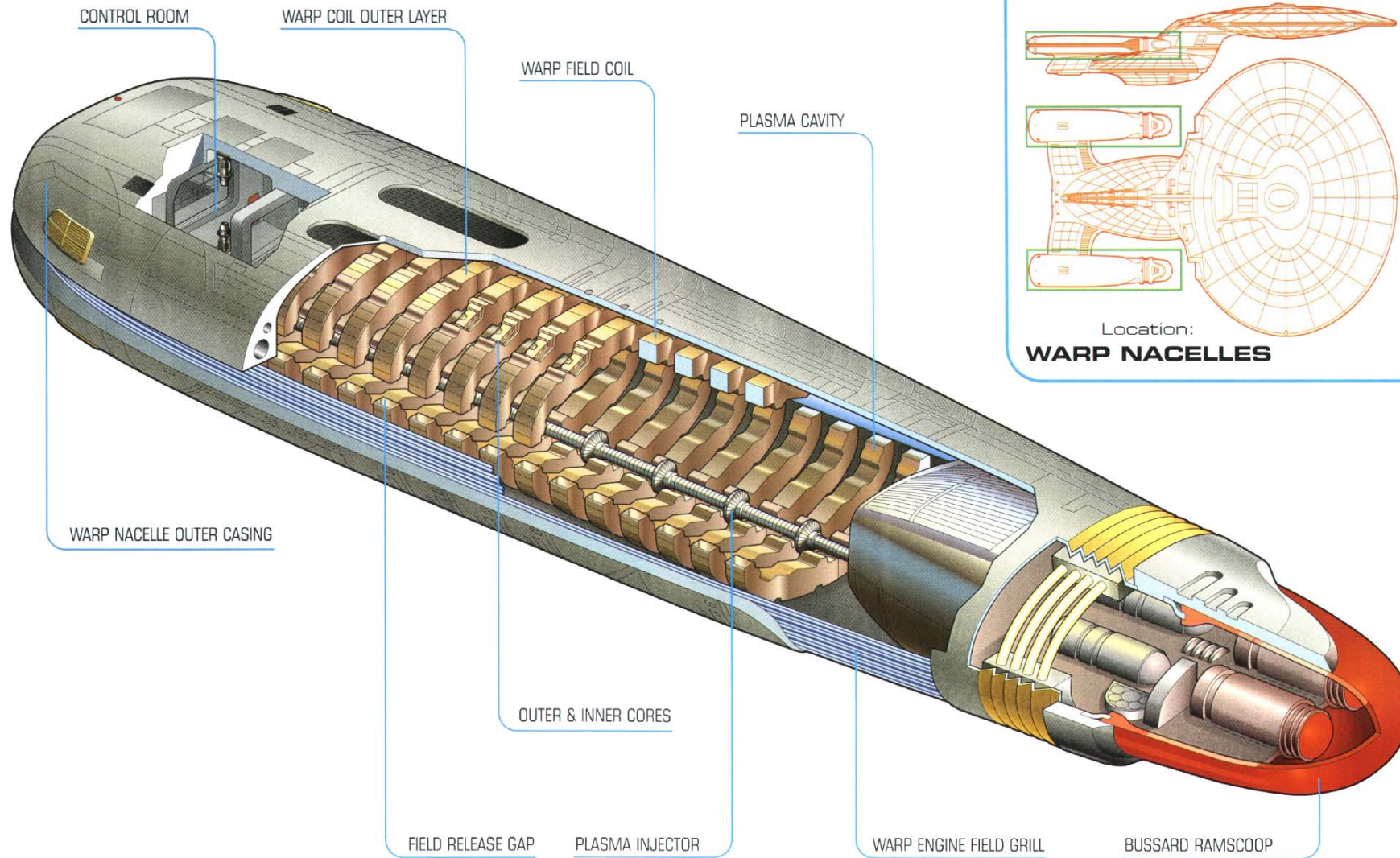

added benefit of this arrangement appeared during design modeling, since it made the warp field more triangular, providing better X/Y/Z-axis control. Improvements in warp core design increased power to 150% of that of the *Enterprise* class, though reactant consumption also rose, now to 200%. A second class of dreadnoughts, the *Ascension*, was also created, using the *Belknap* class cruiser as its model. It had similar power and reactant adjustments.

Four nacelles did not enter Fleet service until the commissioning of the *Constellation* class

exploratory cruiser. These vessels were designed to operate on the extreme edge of Federation space for mission periods exceeding ten years or more. As repair facilities would be few and far between, it was decided to use four LN-68 nacelles to reduce the stress on the warp system as a whole, to provide spare parts for repairs and, if necessary, act as a "backup" set of warp nacelles in the event of a severe systems failure in the warp propulsion system. This design, while inelegant, was functional and a number of ships were built. With all four nacelles in use, total power was 200% and reactant consumption was 300% compared to when she ran on two nacelles. Since the *Constellation* class was somewhat unique in its mission design objectives, the ridiculous waste in consumables of four-nacelle operation was considered acceptable, though it remained the only four-nacelle vessel built.

In the late 2300's, the arise of more Threat elements against the Federation once again brought the call for vessels with more than two nacelles. And once again, a third nacelle was grafted to a cruiser, in this case the *Galaxy* class, resulting in the *Olympus* class dreadnought. The Star Fleet Corps of Engineers, in a guerrilla war worthy of the Maquis, finally rammed through a new four-nacelle design, the U.S.S. *Peacekeeper* diplomatic cruiser, again based on the *Galaxy* class.

The ASDB is generally against vessels with more than two nacelles, citing the new LF-43 series which, when mounted on the *Galaxy (III)* class large exploratory cruiser, raised its top speed to within 10% of the *Olympus*, while using nearly half as much reactants. Therefore, it is unlikely we will see any more three or more nacelle designs in the near future.

---

**Admiral Newey is a Technical Director at the Star Fleet Spacecraft Design Advisory Commission and is an acknowledged expert in high-warp design dynamics.**





# THE GALAXY CLASS - TEN-YEAR SERVICE REPORT

## EXAMINING THE FIRST DECADE OF SERVICE

**CAPTAIN SHAN PU**  
**EXECUTIVE OFFICER - STARSHIP U.S.S. BRIGHT STAR • NCC-71875**  
**OCTOBER 2373 ISSUE**

This month is the tenth anniversary of the commissioning of the most famous *Galaxy* class starship — the U.S.S. *Enterprise* • NCC-1701-D. Though she was lost in the line of duty, her name lives on in the new *Sovereign* class. And with nine vessels in service, the *Galaxy* class remains at the forefront of the Galaxy Exploration Command.

There are some within Star Fleet who feel that the *Galaxy* class, if not an outright failure, has failed to live up to the expectations placed on her when the first ship was launched in 2357. Myself, I feel the *Galaxy* class has proven to be an unqualified success as an Explorer. Though the U.S.S. *Yamato* and U.S.S. *Odyssey* were also lost in the line of duty, the remainder continue to serve Star Fleet and the Federation in front-line roles. Like her predecessors in the *Constitution* and *Enterprise* classes, the *Galaxy* has served as the basis for numerous new starship designs, allowing Star Fleet to stretch its shipbuilding budget by removing the need to design new starships from scratch and allowing the standardization and “mass production” of components.

The *Galaxy* class was superseded in 2370 by the launching of the first *Galaxy (II)* class starship—the U.S.S. *Bright Star*. Many of the new systems first implemented on this class have been fitted to the *Galaxy* class starships constructed afterwards. Over the past decade, numerous changes and updates have been incorporated first into the *Galaxy* class, with many of them then being carried to the remainder of the Fleet. So far, this seems to have helped correct some of the technical and tactical deficiencies discovered in the class once in service.

When first launched, the *Galaxy* class was the largest and most powerful vessel in Star Fleet. Though first the *Olympus*, and then the *Courageous* class have now taken that position, the *Galaxy* class remains the most flexible starship platform in the Fleet and will probably far-outlive her larger sisters in terms of service to Star Fleet.

Though she may no longer be the “biggest and the fastest”, the vessels of the *Galaxy* class continue to prove their motto of “Star Fleet’s Best”.

---

**Captain Shan Pu has served as the Executive Officer of the U.S.S. *Bright Star* since the vessel's commissioning.**

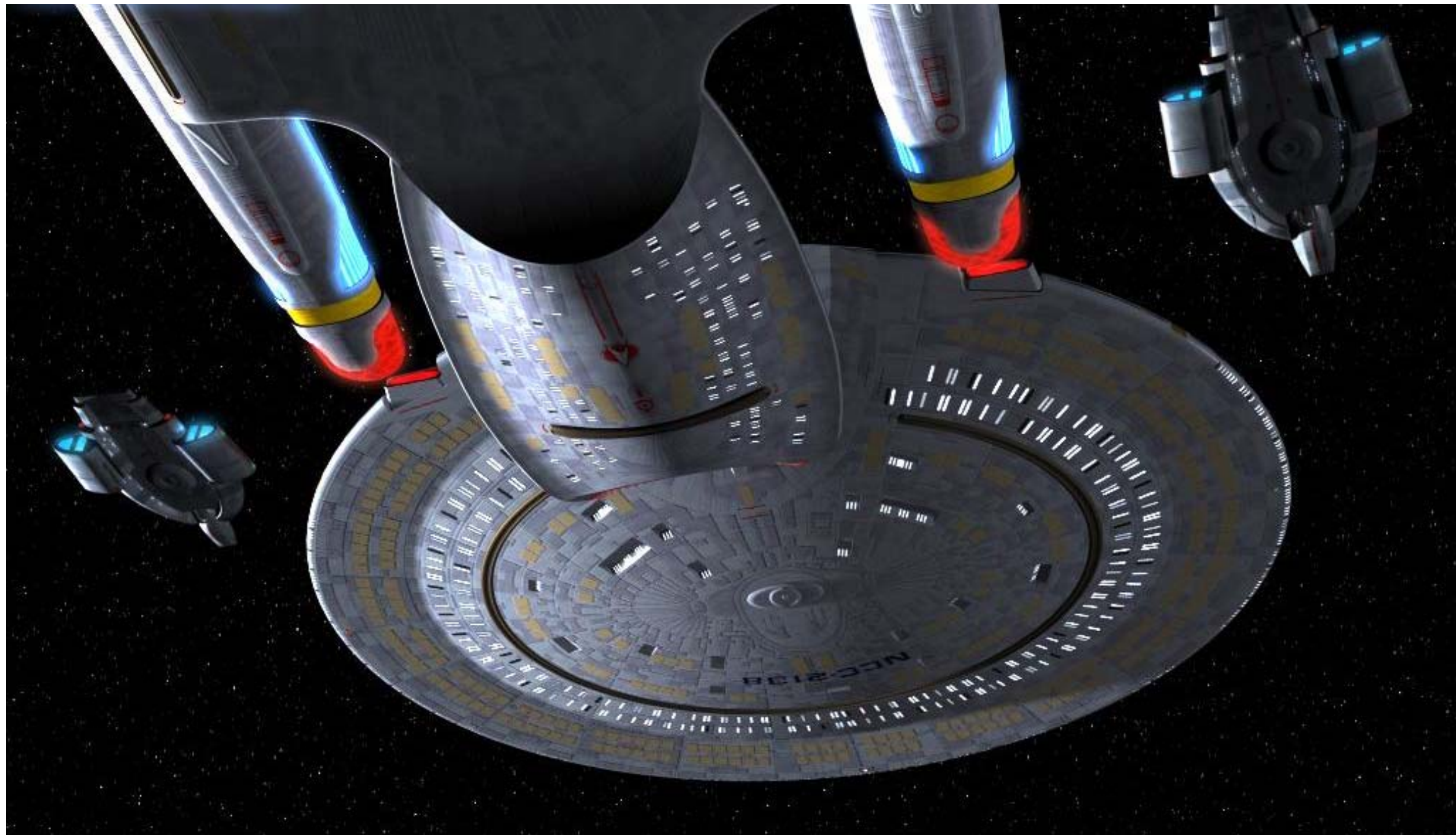



# THE FCE-2 CLOAKING DEVICE

## A SECOND LOOK AT A CONTROVERSIAL SYSTEM

**CAPTAIN JOHN H. HARRIS**  
**CHAIRMAN - ADVANCED STARSHIP DESIGN BUREAU**  
**OCTOBER 2373 ISSUE**

During the late 2200's, most Star Fleet ships were equipped with a cloaking device. Designated the FCE-1, it was based on Romulan and Klingon technology stolen by James T. Kirk.

When the United Federation of Planets signed the Treaty of Algeron with the Romulan Star Empire, Star Fleet Intelligence was unaware that the Romulans had already replaced their earlier design with a new unit that was undetectable by current Star Fleet sensor technology. The Romulans shared this with the Klingons, and suddenly Star Fleet found itself at a distinct tactical disadvantage. Through hard work and counterintelligence operations, a tachyon-based detection network was eventually developed.

Though things look bleak, the Federation did have a trump-card that they could play. The Treaty allowed the Federation to continue to develop cloaking technology. In 2366, the fruits of this development program were debuted in the FCE-2, which was developed in conjunction with the FSS shield system. The FSS/FCE-2 combination entered service in 2367 with the U.S.S. *Griffon* and U.S.S. *Pendragon*. Three years later, the U.S.S. *Bright Star* commissioned with the same system.

To put it mildly, the Romulans screamed foul. They declared that the FCE-2 was in violation of the Treaty and that it was a "dangerous escalation" in tensions between the two powers. Rear Admiral Chris Wallace, Director of the Department of Technical Services and Chairman of the ASDB at the time, invoked a loophole in the Treaty and claimed that the FCE-2, with its significant

tactical limitations, was not a "first-strike" weapon, and therefore eligible under the Treaty. The Romulans objected, but agreed to high-level talks on the issue. After intense negotiations, it was decided that the Federation could install the system on a total of five Classes, with no more than ten vessels of each Class fitted. At this time, the *Galaxy (II)*, *Griffon*, and *Nomad* Classes have been chosen, with a total of five ships having been fitted. Agreeing to these conditions and the other restrictions under the Treaty of Algeron, the Federation developed a recurring mission profile that takes advantage of the capabilities of the FCE-2: pre-first contact observations of those cultures on the cusp of warp drive. Since such cultures have the technology to detect warp-drive vessels, it is only logical that the FCE-2 cloaking device be used to shield the observing ship from detection.

Of course, there have been sanctioned attempts made by crews of ships equipped with the FCE cloaking device to employ it in tactical situations, usually during "freedom of navigation" exercises in border areas. However, considering the problems in using the FCE-2 for such a mission, it is not surprising that all such attempts have failed, and the vessels have been detected. This has led to several diplomatic protests being lodged by the Romulan Government, but no other action.

---

**Captain Harris currently serves as Director of the Star Fleet Advanced Starship Design Bureau.**

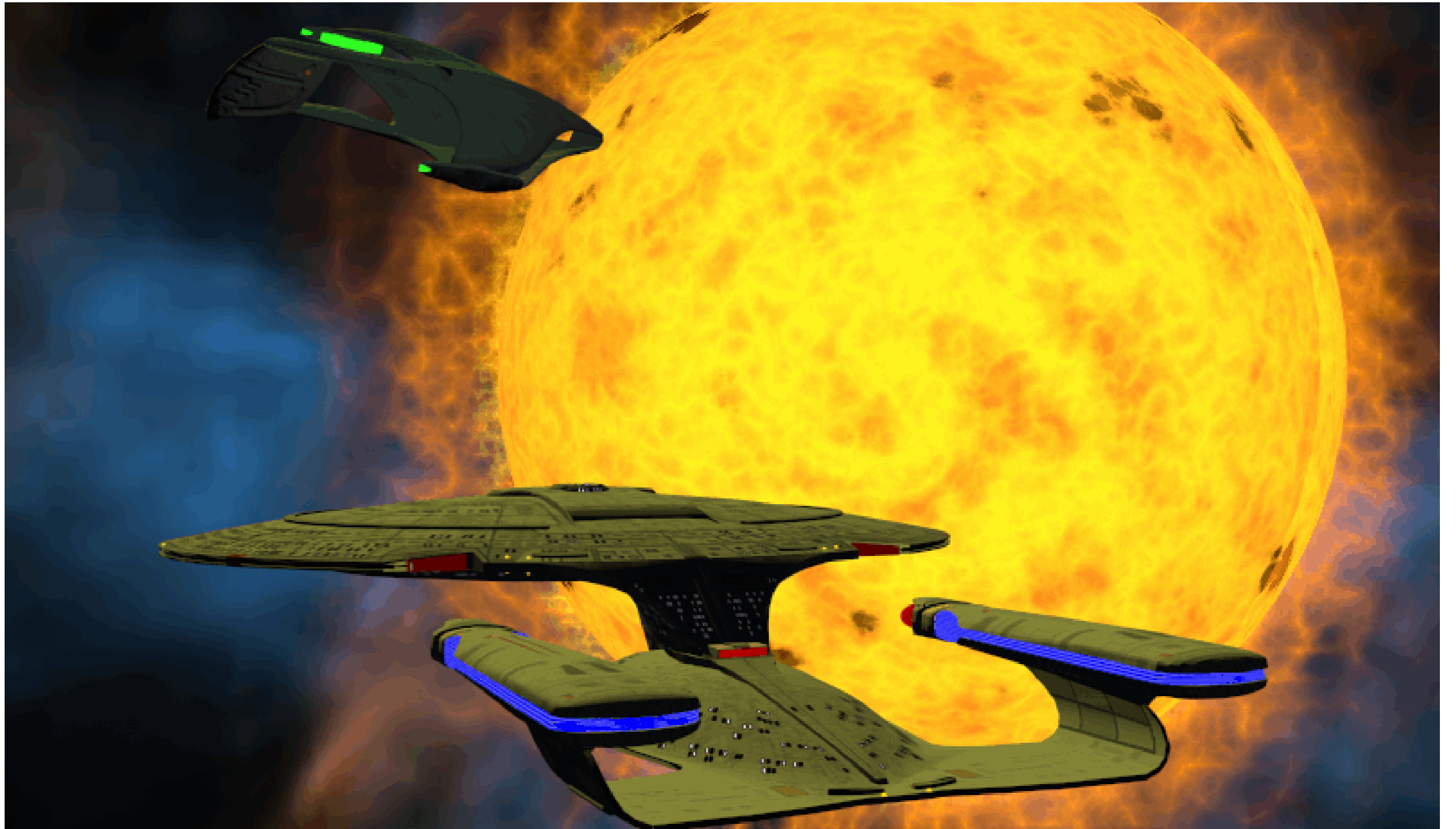



# KLINGON VESSELS IN STAR FLEET?

## A CONTROVERSIAL PROGRAM TO SUPPLEMENT THE FLEET

VICE ADMIRAL SAN ASHITAKA  
FEDERATION INTELLIGENCE AGENCY - KLINGON SECTOR  
OCTOBER 2373 ISSUE

Star Fleet has been dedicating the majority of shipyard space to the construction of large explorer-type vessels such as the *Galaxy* and *Nebula* Classes, at the expense of patrol and picket vessels. When this policy was implemented, the Federation was at peace with her neighbors and older *Miranda* and *Soyuz* Class frigates ably carried out such duties.

Things have changed much since then. The Romulans have returned, the Klingons have suffered internal strife which has at times spilled over into Federation space, and pirates, smugglers, and Ferengi run amuck. With the loss of 39 Ships of the Line at the Battle of Wolf 359, Star Fleet has been hard pressed to contain everything. The new *Cochise* Class of destroyers is hoped to correct this, but it will be some time before they are available in sufficient numbers to have the desired effect.

The Office of the Commander, Star Fleet ordered a study to be undertaken by the Office of the Chief of Operations on the feasibility of adopting Klingon vessels to a patrol role. Star Fleet's Executive Committee wanted to promote closer ties with the Klingon forces, and thought adding some Klingon vessels would help correct the lack of patrol ships in the short term. The Department of Technical Services was brought in to assist in the evaluation of this proposal.

The U.S.S. *Kronos* (ST-100001), a Klingon K-22 *D'Gavanna* (*Bird of Prey*) Class scoutship, has been in Star Fleet's possession since Admiral James T. Kirk captured it over eighty years ago during the Genesis Incident. Though decommissioned and mothballed for well over a half-century, the

vessel was updated to current Klingon specs for the Class and put into service as a picket. Though the evaluation team found the ship to be inferior in terms of speed, capability, and technology when compared to Federation vessels, the innate toughness of the ship and dedication to purpose made the vessel surprisingly well-suited to the picket / patrol role.

At this time, the idea is no more than that. While the Klingons are offering vessels at exceptionally favorable prices, there are many within TacFleet who are unsure as to the wisdom of spending money on such a venture, as opposed to using it to speed up the procurement of *Cochise* and *Defiant* Class vessels.

---

**Admiral Ashitaka is the Chief of Starship Analysis for the Klingon Sector of the Federation Intelligence Agency.**



# **STARSHIP ARTICLES**



# THE PEACEKEEPER CLASS DIPLOMATIC CRUISER

## “MAKING BIGGER SHIPS GO FASTER”

**CAPTAIN PAUL WALKER**  
**DIRECTOR - PEACEKEEPER CLASS STARSHIP DEVELOPMENT PROJECT**  
**COMMANDING OFFICER - STARSHIP U.S.S. PEACEKEEPER • NCC-72300**  
**JANUARY 2372 EDITION**

Ever since the decommissioning of the last *Constellation* class exploratory cruiser, the Star Fleet Corps of Engineers have been pressing for a new generation of quad-nacelle vessel to replace them, though it was a hard-fought battle. They finally succeeded in 2345 with the approval of the *Cheyenne* class superscout.

The *Cheyenne* was designed to act as a high-speed scout to compliment the *Galaxy* class Large Exploratory Cruiser under development at the time. As such, the ship needed a top sustained cruising speed of Warp 8 and a top speed of Warp 9.7. To achieve these speeds, it was decided to use four nacelles, and the ship soon became a contemporary version of the *Constellation* class of the late 2200s.

The lead vessel entered service in 2345 and almost two dozen were built. Most continue to serve in deep-space exploration roles, though the new *Intrepid* class is designed to offer better speed at far greater efficiency and will no doubt be replacing the *Cheyenne*'s over time.

### DEVELOPMENT BACKGROUND

The Advanced Starship Design Bureau has long been opposed to a vessel with four nacelles, citing the added cost and complexity of such a design. Current tandem-nacelle designs can power vessels of truly enormous sizes (upwards of 6,000,000mt displacement) to speeds past Warp 9. In addition, as the number of nacelles rise, so does the fuel consumption. A single

nacelle has a Power Index (PI) of 1.0 and a Fuel Consumption Index (FI) of 1.0. Two nacelles raises the PI to 1.5, but the FI rises only to 1.25. However, three nacelles raises the PI to 2.0 and the FI to 2.5. And four nacelles is even worse, with PI rising to 3.0 and FI to 4.0. So a four nacelle vessel makes twice as much power as a dual nacelle vessel, but uses over three times as much fuel to generate it.

The *Olympus* class uses three-nacelles due to the power needs of her weapons and shield systems, and for attaining a sustained top speed of Warp 9.9 (currently the upper limit of Federation structural design). The ASDB has been content to work on continued improvements in traditional dual nacelle designs. Nonetheless, the Corps of Engineers, emboldened by the *Olympus* class, started a campaign to develop a four-nacelle testbed using the *Galaxy* platform. Though against production, the ASDB did agree to fund the simulation testing of such a ship. Simulations proved that the Corps were on to something, and they were able to convince the ASDB to designate one of the uncompleted *Galaxy* class shells as an Engineering testbed. This vessel was named *Werner von Braun* in honor of one of the Terran fathers of rocketry.

Shortly after the ship was moved to Utopia Planitia, Leeder Energies announced the new LF-43 series. A significant improvement on the LF-41 series used in the *Galaxy* class, it provided 20% more peak power at nearly the same fuel-index. The ASDB was deeply impressed, and ordered it fitted on the *Werner von Braun* (as well as the *Galaxy (II)* test-bed *Bright Star*). In addition to yanking the Corps' testbed ship, the ASDB cancelled the four nacelle simulation program at the



same time, siting further development was pointless in lieu of the LF-43.

The Corps of Engineers were outraged, and petitioned the construction of another vessel. Two things worked in their favor. While it would eventually prove successful, the LF-43's testing was taking longer than expected, delaying completion of both *Bright Star* and *von Braun*. Second, the Office of Diplomatic Affairs had begun a design study for a specialized ship to serve in "First Contact" roles with advanced civilizations, serve in ambassadorial roles with other systems, and enforce peacekeeping duties undertaken by the Federation. The Corps of Engineers rapidly adapted their original proposal to meet what the ODA was looking for, and the two successfully forced the design past the SSDAC. This new vessel was to be named *Peacekeeper* and, again, one of the uncompleted *Galaxy* class spaceframes was dedicated to the task. At the demands of the COE, the engineering spaces and nacelles were installed first, to ensure the ship was completed as designed.

### GENERAL APPEARANCE

The *Peacekeeper* class looks essentially like a *Galaxy* class starship, with the exception that she mounts an additional pair nacelles under the standard two. Additionally, a weapons "roll-bar" has been grafted to the top of the saucer section, marring the otherwise sleek lines of the *Galaxy* class.

### PROPULSION AND POWER SYSTEMS

Extensive modification was necessary to the nacelle struts to mount two nacelles each, in addition to the necessary plumbing to feed both units. Significant upgrades to the SIF and IDF generators have been incorporated, including modifications to the computer core to maintain proper warp field geometry.

### TACTICAL SYSTEMS

In addition to the standard ten Type X phaser strips, an additional two have been added to the roll bar. A total of six Mk 80 photon torpedo launchers are fitted, with two aft and two forward firing added to the roll bar. The FSQ/2 shielding system is fitted. The specialized Marine fittings from the *Olympus* class have been added to the *Peacekeeper*. Standard Marine compliment is 500, though more can be carried in emergencies. Twenty Type 10 combat drop shuttles have been added to the ship's embarked craft listing, for use when the combat transporters cannot be employed.

### COMPUTER SYSTEM

It was decided to use the M-15 Isolinear III computer system. The engineering core is a slightly modified version of the one used on *Olympus*, with specialized logic to deal with the intricacies of four nacelle warp dynamics.

### SHIPS FACILITIES

The scientific sections have been reduced by 15% to allow the fitting of more VIP quarters and specialized conference facilities. Both sickbay and the medical staff have been increased by 25%, with most of the personnel and facilities geared for xenospecialists in various fields.

### DEVELOPMENT AND CONSTRUCTION HISTORY

The ASDB and COE finalized the design in 2369. Construction began immediately on the engines, while the remaining superstructure was quickly fitted out. The ship was launched in December of 2371 and entered service the following year, undertaking a rigorous testing regimen.

### CONCLUSION

At this time there are no plans to build any additional vessels of this type. The LF-43 series of engines perform extremely well, and their efficiencies cannot be ignored. In addition, the upper roll bar has proven to have a negative effect on the ship's warp geometry, though the sheer power of the ship makes up for it.

---

**Captain Walker previously served on the *Olympus* class dreadnought U.S.S. *Shadowguard* and is familiar with multi-nacelle warships. A member of the Star Fleet Corps of Engineers, he successfully led the fight to produce the *Peacekeeper*. As such, he was chosen to command her.**

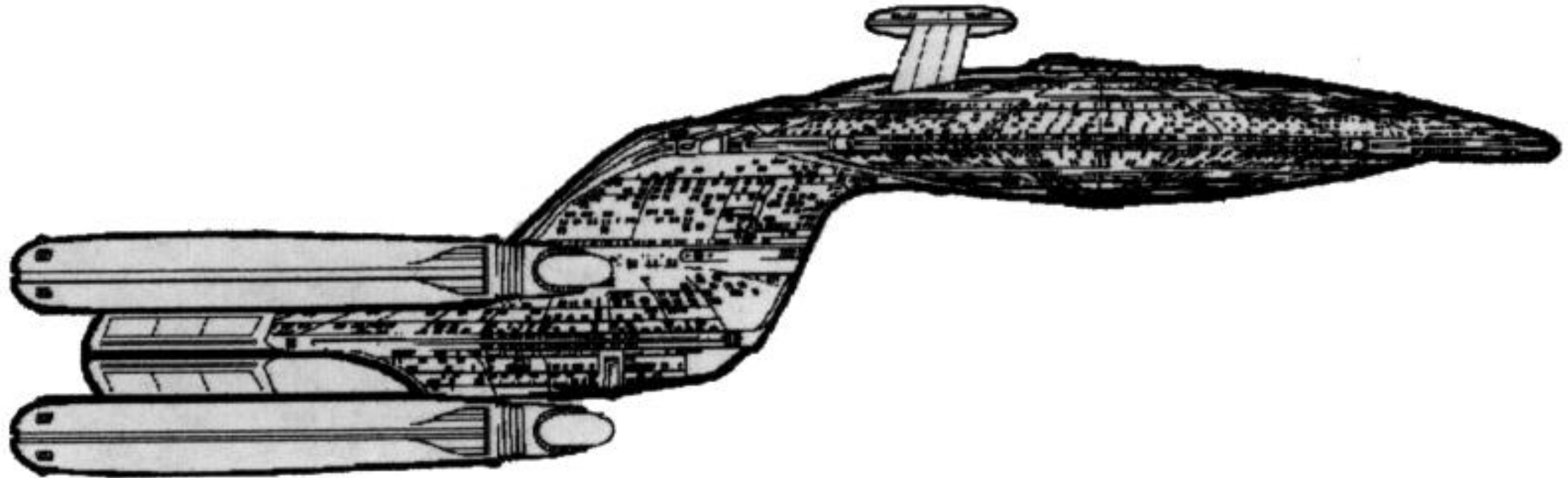

## Peacekeeper Class Diplomatic Cruiser

Displacement	5,400,000 mt
Overall Length	642.51 m
Overall Draft	190.5 m
Overall Beam	463.73 m
Propulsion:	Four LF-41 Mod 1 energized-energized antimatter warp drive units (System Contractor: Leeding Energies, Sydney, Earth)
	Two FIG-5 subatomic unified energy impulse units (System Contractor: Kloratis Drives, Tellar)
	QASR-2 particle beam maneuvering thrusters (System Contractor: Scarbak Propulsion Systems, Earth)
	"Trentis IV" pulsed laser reaction control system (System Contractor: Orage Ijek, Aksajak, Andor)
Velocity:	Warp 7.0 Standard Cruising Speed
	Warp 9.5 Maximum Cruising Speed
	Warp 9.9 Maximum Attainable Velocity
Duration:	5 years, standard
Complement:	200 Officers
	1000 Enlisted Crew
	300 Diplomatic Personnel
	450 Security Forces
	50 Flight Crew
	500 Passengers (Normal – Up to 5000 Maximum)
	2000 Total Crew (Standard)

Embarked Craft:	3 Danube Class Runabout
	4 Type 6 Personnel Shuttle
	2 Type 7 Personnel Shuttle
	2 Type 9A Cargo Shuttle
	20 Type 10 Combat Drop Shuttle
	8 Type 16 Shuttlepod
	4 Peregrine Class Fighter
Navigation:	RAV / ISHAK Mod 3 Warp Celestial Guidance (System Contractor: Tlixis Ramab RRB, Coridan III)
Computers:	M-15 Isolinear III with LCARS interface software (System Contractor: Daystrom Computer Systems, Luna)
Phasers:	12 Type X Collimated Phaser Array (System Contractor: HiBeam Energies, Earth)
Missiles:	6 Mk 85 Photon Torpedo Launchers (System Contractor: Loraxial, Andor)
Defense:	FSQ/2 Primary Force Field (System Contractor: Charlotte Shields, Earth)
Life Support:	MM6 Modular Gravity Unit (System Contractor: Morris Magnatronics, Palyria, Mars)
	AL4 Life Support System (System Contractor: A'Alakon Landiss, Divallax, Andor)



# THE FLYNT CLASS BATTLECRUISER

## A JOINT FEDERATION-KLINGON STARSHIP DESIGN

LIEUTENANT COMMANDER BYRON G. FLYNT  
SENIOR ENGINEERING OFFICER - STARSHIP U.S.S. COMANCHE • NCC-71809  
OCTOBER 2373 EDITION

Though the United Federation of Planets and the Klingon Empire are allies, that alliance does not extend to the military forces of each government. Federation crews man Star Fleet ships, and Klingon Defense Force ships are crewed by Klingons.

With the outbreak of general war in the Alpha Quadrant against the Dominion, talks between the two governments about integrating their forces began in earnest. The result is the combined Federation and Klingon forces that have engaged the Dominion on numerous occasions.

An informal grouping of Federation and Klingon engineering officers formed a “design bureau” to extend this new-found cooperation to the next level — a joint Federation-Klingon starship design. The first of the was the *Q’pla* class, and the most recent is the new *Flynt* class battlecruiser.

### GENERAL APPEARANCE

The *Flynt* class was designed by the Klingon side of the bureau, and follows their traditional form of angles, planes, and arcs. Klingon starship design calls for a vessel to “pierce” subspace when in warp flight, as opposed to the general “slicing” of Federation designs. The initial plan was for the vessel to mount four nacelles, but with dimensions of over 1000m in length and 500m in width, such a vessel would not fit in any Federation or Klingon starbase or orbital facility. In

consultation with the ASDB, the ship was scaled down by over half, and is now about 25% smaller than the *Galaxy* class starship.

### PROPULSION AND POWER SYSTEMS

The vessel mounts three LF-41 warp nacelles, all underneath the ship. Klingon warp designs are insufficient to power such a massive ship at high-warp velocities, so Federation designs were chosen.

### TACTICAL SYSTEMS

Tactical systems are Federation in origin, with sixteen Type X phaser strips providing far more effective fields of fire than traditional Klingon disruptor cannon. Four Mk 80 photon torpedo launchers are fitted, in a dual forward / dual rearward firing configuration. Shielding is provided by the FSQ system and the standard Federation CETIS/TACAR fire-control suite is fitted.

### COMPUTER SYSTEM

The *Flynt* is equipped with the standard M-15 Isolinear III computer system found on most class

One ships of the line.

### SHIPS FACILITIES

Though Klingons will consider it soft, the *Flynt* was designed with Star Fleet living-quarters standards in mind. This allows a crew of around 700 with space for up to an additional 1000 people.

### CONCLUSION

It is currently unknown whether or not such a vessel would, or even could, be built. While such a design concept is intriguing, it is unknown exactly how much technology transfer, especially in tactical and computer systems, would be allowed. There are many questions that will need to be examined, but one must admit it is an intriguing concept.

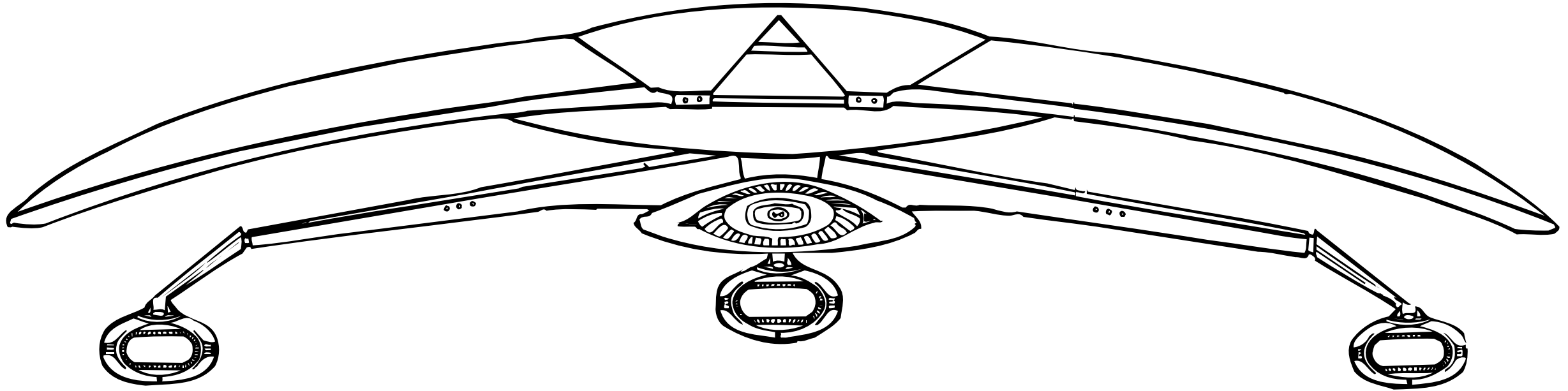

---

Commander Flynt, for whom the class is named after, is the Senior Engineering Officer of the starship U.S.S. *Comanche*.

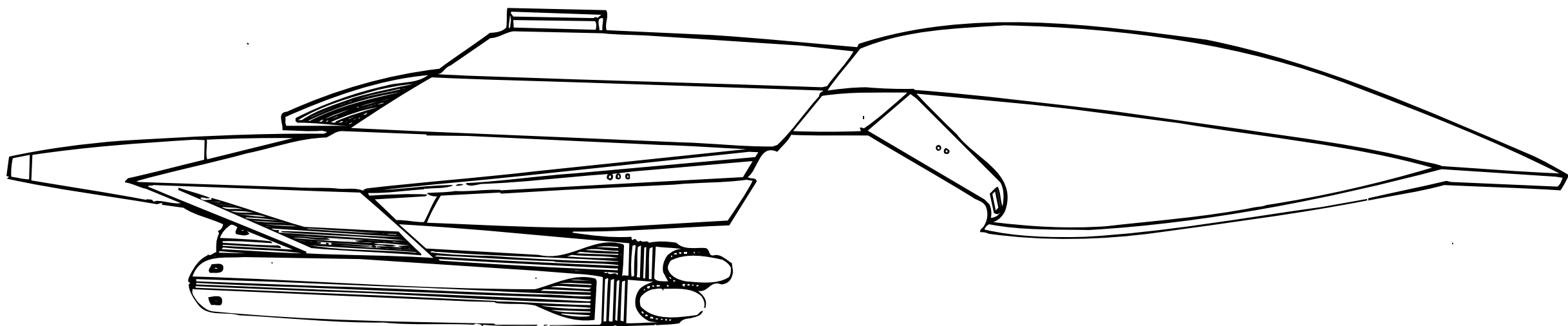

## Flynt Class Battlecruiser

Displacement	3,028,000 mt
Overall Length	481.8 m
Overall Draft	103.1 m
Overall Beam	420 m
Propulsion:	Three LF-41 Mod 1 energized-energized antimatter warp drive units (System Contractor: Leeding Energies, Sydney, Earth)
	Two FIG-5 subatomic unified energy impulse units (System Contractor: Kloratis Drives, Tellar)
	QASR-2 particle beam maneuvering thrusters (System Contractor: Scarbak Propulsion Systems, Earth)
	"Trentis IV" pulsed laser reaction control system (System Contractor: Orage Ijek, Aksajak, Andor)
Velocity:	Warp 6.0 Standard Cruising Speed
	Warp 9.0 Maximum Cruising Speed
	Warp 9.5 Maximum Attainable Velocity
Duration:	5 years, standard
Complement:	100 Officers
	700 Enlisted Crew
	0 Passengers (Normal – Up to 500 maximum)
	500 Marines
	1800 Total Crew (Standard)

Embarked Craft:	1 Danube Class Runabout
	4 Type 6 Personnel Shuttle
	4 Type 7 Personnel Shuttle
	4 Type 9A Cargo Shuttle
	10 Type 10 Combat Drop Shuttles
	6 Type 16 Shuttlepod
Navigation:	RAV / ISHAK Mod 3 Warp Celestial Guidance (System Contractor: Tlixis Ramab RRB, Coridan III)
Computers:	M-15 Isolinear III with LCARS interface software (System Contractor: Daystrom Computer Systems, Luna)
Phasers:	16 Type X Collimated Phaser Array (System Contractor: HiBeam Energies, Earth)
Missiles:	4 Mk 80 Photon Torpedo Launchers (System Contractor: Loraxial, Andor)
Defense:	FSQ/2 Primary Force Field (System Contractor: Charlotte Shields, Earth)
Life Support:	MM6 Modular Gravity Unit (System Contractor: Morris Magnatronics, Palyria, Mars)
	AL4 Life Support System (System Contractor: A'Alakon Landiss, Divallax, Andor)

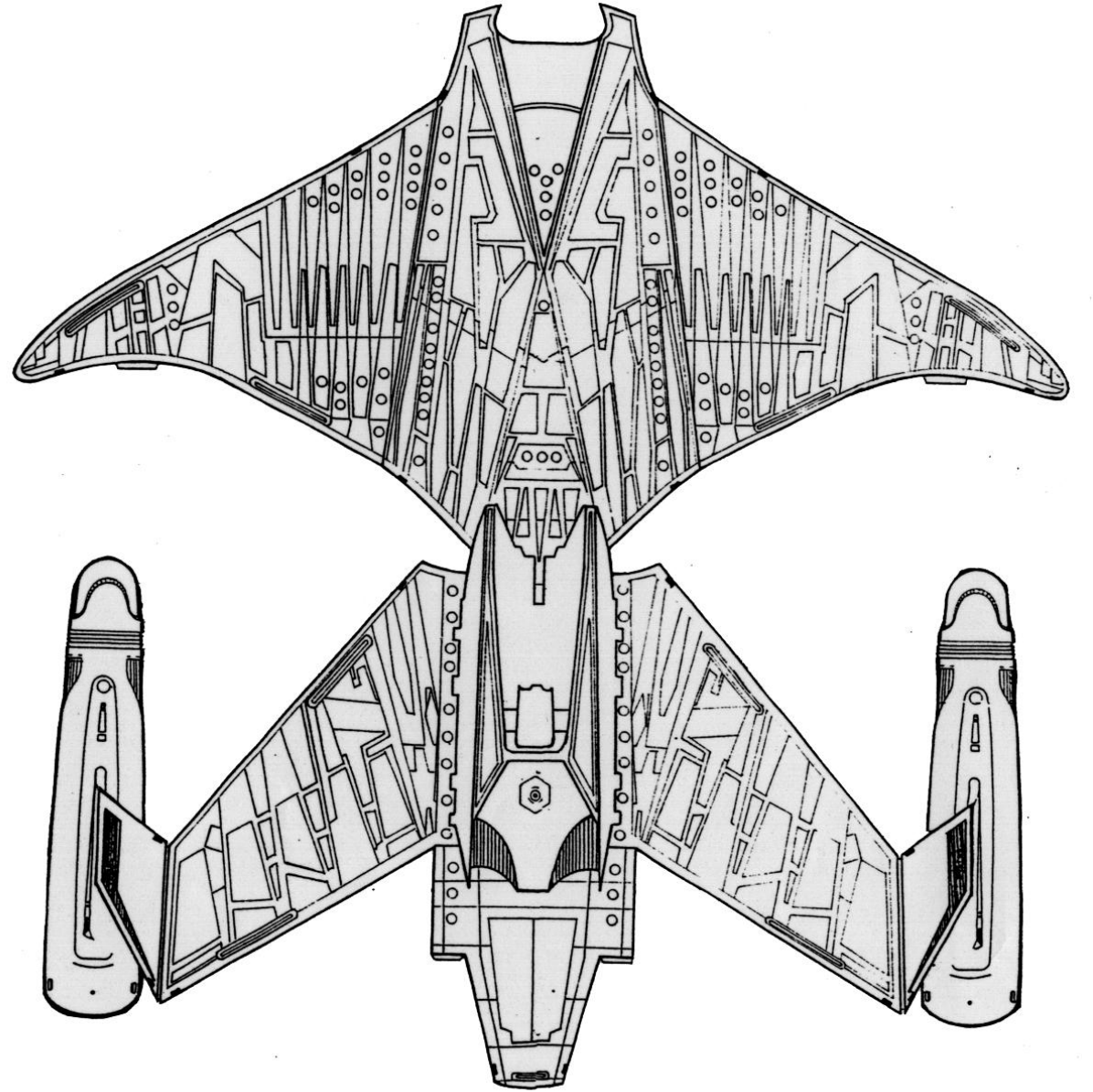
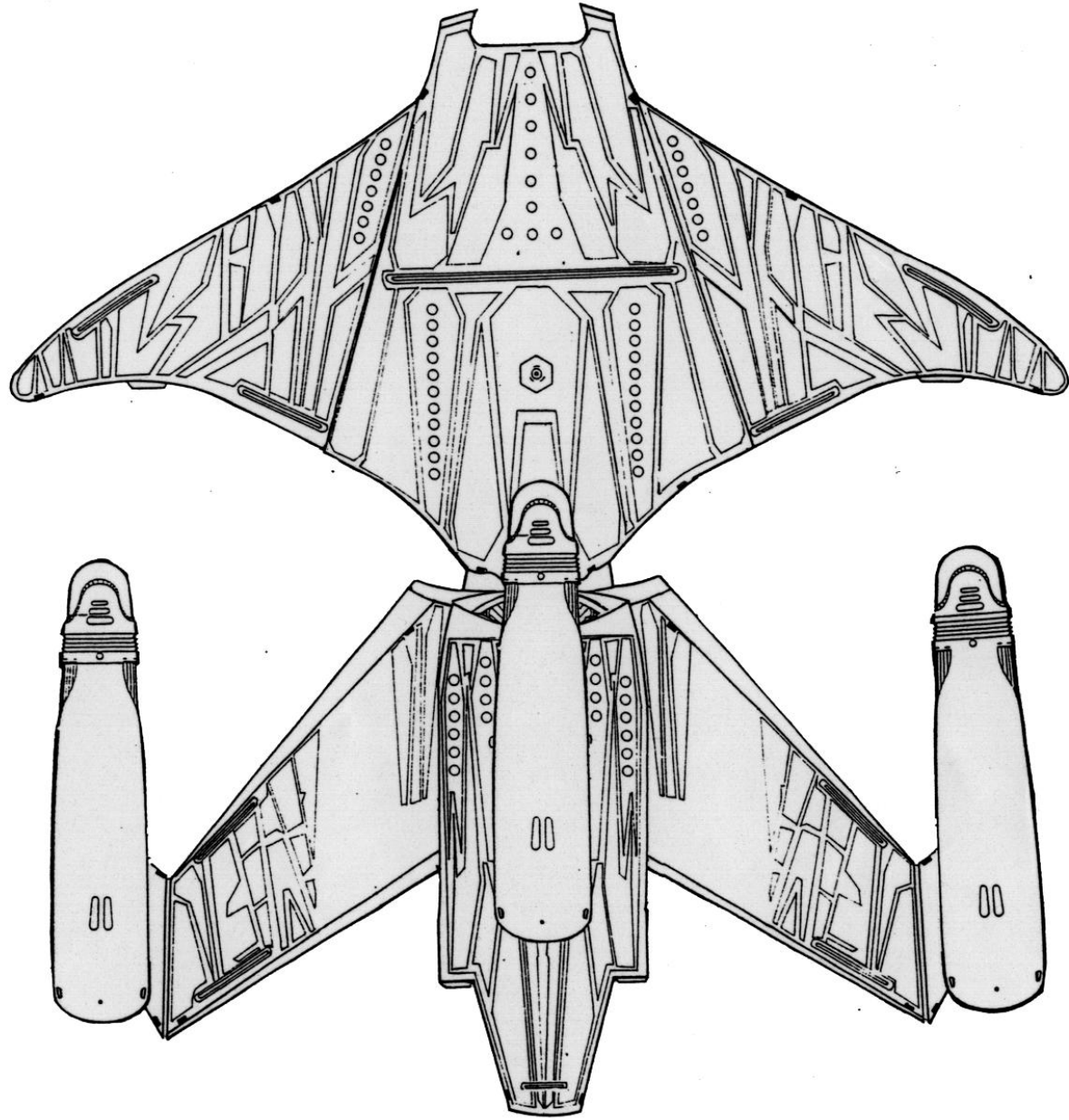



# THE U.S.S. JAGUAR

## AN INTREPID-CLASS DIPLOMATIC CRUISER

ADMIRAL CHRIS WALLACE  
COMMANDING OFFICER - STARSHIP U.S.S. JAGUAR • NCC-74750  
JANUARY 2380

The *Intrepid* class has become one of the more versatile starship platforms in Star Fleet since they entered service not quite a decade ago. Designed as a high-speed Explorer to support the larger *Sovereign* and *Galaxy* classes, the class' high speed and strong tactical suite made it a favorite amongst Star Fleet Admirals and diplomats during the Dominion War.

With the huge losses Star Fleet suffered during the War, emphasis is being placed on rebuilding the Fleet's strength to both enforce the peace and prevent other powers, Major and Minor, from exploiting the Fleet's weakness. The *Intrepid* class has been chosen as the core of the new Fleet and orders for twenty new vessels have been placed to augment the original twenty.

### DEVELOPMENT HISTORY

During the war, there was a need for a high-speed diplomatic courier vessel to travel between the three Allied powers. The *Nova* class Courier was used, as was the *Cheyenne* class, both due to their high-sustained speeds thanks to their four warp nacelles. However, neither ship was designed for combat duty, and were not sent into harm's way. For those missions, *Intrepid* class Exploratory Cruisers were used, due to their high speed and heavy armament.

The *Intrepid* was quite successful in this role and, after the War, Star Fleet looked hard at possibly modifying one or more of the new-build *Intrepid* class vessels to true diplomatic cruiser specifications. As Chairman of the SSDAC, my group was charged with preparing a proposal for

such a vessel.

It was determined that the current propulsion systems aboard the *Intrepid* class were more than adequate, as the ship has one of the highest sustainable and attainable top speeds of any ship in known space.

### COMPUTER SYSTEM UPDATES

The *Galaxy (II)* class vessel U.S.S. *Bright Star* was fitted with an experimental computer relay system based on "bio-neural gel packs" in addition to traditional isolinear chips. Classified as the M-16 Isolinear III, it utilized synthetic neurons based on the organization of neurons and synapses in the humanoid brain. The system essentially "grows" new computer circuits as needed. This allows the computer to take a "best guess" in cases where there is insufficient information to make a definitive statement in a logical manner, rather than having to spend the time attempting to calculate all possible actions. In essence, it uses a more intuitive process to arrive at a decision. After successful testing on the *Bright Star*, the system was fitted to the *Intrepid* and other *Galaxy (II)* class starships.

The *Galaxy (II)* class also added a highly advanced artificial-personality program called E.V.E. (Enhanced Visual interface) on top of the standard LCARS software, providing enhanced computer-human interactions. This system has been added to the U.S.S. *Jaguar* and may be

fitted to future *Intrepid* class starships.

### **TACTICAL SYSTEMS UPGRADES**

The *Intrepid* class already mounts an impressive and powerful tactical suite. Nonetheless, it was decided to improve this to the latest standards. Therefore, the standard five Type X phaser strips have been upgraded to Type XII. The two Mk 90 photon torpedo launchers are the current state of the art, and remain unchanged. She is also one of the few ships currently carrying the new quantum torpedo. CETIS Mk III with Type 225TACAR (Target Acquisition Center Accelerated Response) is standard equipment.

In a nod to try and produce a cheaper command ship, *Jaguar* was fitted with an AEGIS Mk 7 mod 1 Fleet Fire Control System, a CIC, a Link 35 Communications Core, Flag Plot Holodeck, and 42/ADA Countermeasures Support System.

The FSS shield system was considered, but such a system was designed for a far larger vessel and there was no way to place the shield grid generators on the hull. Therefore, the FSQ/2 system upgrade was fitted, making the vessel extremely well-defended.

### **SHIPS FACILITIES**

The *Intrepid* class is geared for exploration, and therefore has one of the most advanced sensor suites in service. The crew also carries a large Sciences compliment to support it. It was decided to leave the exploration suite alone, but to reduce the Sciences compliment by 25%. The reason for such a reduction is that the vessel is not expected to perform serious exploration and scientific missions.

The reduction in Sciences crew has been transferred to a new Diplomatic Support team which will handle diplomatic-related duties. In addition, twenty large VIP quarters have been added, as well as five meeting rooms — one large, two medium, and two small. The ship's galley has undergone extensive refitting and enlargement, so as to handle diplomatic functions.

### **CONSTRUCTION HISTORY**

Though she was slated to be the last of the new vessels built, it was decided to choose the U.S.S. *Jaguar* (CA 74750) as the platform to modify. That way, should the new class be successful, *Jaguar* can become a new sub-class and future models can be numbered sequentially after her.

The vessel was started in January of 2378 in the Hakon Dockyards around Galena. Through a herculean effort by the Hakon workers, the ship was completed in late October of 2379. She is currently undergoing shakedown trials and PSA.

### **CONCLUSION**

*Jaguar* is scheduled to enter service with the Diplomatic Corps in January of 2380. Her first assignment will be with the Fifth Fleet and it is expected the ship will operate out of Spacedock Nexus in the Galena system while the design is reviewed and tested. I have been asked to command the vessel during her first year of trials and development.

---

**Admiral Wallace is a former Chief of Star Fleet Operations and is now the Commanding Officer of the U.S.S. *Jaguar*.**



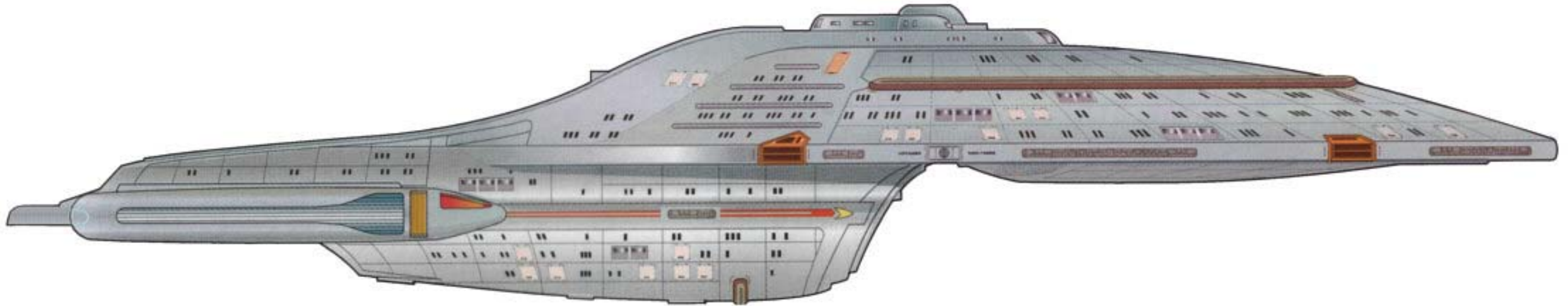

## U.S.S. Jaguar (CR 74750)

Displacement	750,000 mt
Overall Length	343 m
Overall Draft	66 m
Overall Beam	133 m
Propulsion:	Two LF-45 Mod 1 energized-energized antimatter warp drive units (System Contractor: Leeding Energies, Sydney, Earth)
	One FIG-4 subatomic unified energy impulse unit (System Contractor: Kloratis Drives, Tellar)
	QASR-2 particle beam maneuvering thrusters (System Contractor: Scarbak Propulsion Systems, Earth)
	"Trentis IV" pulsed laser reaction control system (System Contractor: Orage Ijek, Aksajak, Andor)
Velocity:	Warp 9.0 Standard Cruising Speed
	Warp 9.975 Maximum Cruising Speed
	Warp 9.98 Maximum Attainable Velocity
Duration:	5 years, standard
Complement:	31 Officers
	10 Diplomatic Support
	100 Enlisted Crew
	0 Passengers (Normal – Up to 30 Maximum)
	141 Total Crew (Standard)

Embarked Craft:	1 Aerowing Type Runabout
	2 Type 6 Personnel Shuttle
	0 Type 7 Personnel Shuttle
	0 Type 9A Cargo Shuttle
	4 Type 16 Shuttlepod
Navigation:	RAV / ISHAK Mod 3 Warp Celestial Guidance (System Contractor: Tlixis Ramab RRB, Coridan III)
Computers:	M-16 Bio-Neural Gel Pack-Isolinear III with LCARS 2.5interface software (System Contractor: Daystrom Computer Systems, Luna)
	AEGIS Mk 7 Mod 1 Fleet Fire Control System (System Contractor: RCA, New York, Earth)
Phasers:	5 Type XII Collimated Phaser Array (System Contractor: HiBeam Energies, Earth)
Missiles:	2 Mk 95 Quantum Torpedo Launchers (System Contractor: Loraxial, Andor)
Defense:	FSQ/2 Primary Force Field (System Contractor: Charlottes Shields, Earth)
Life Support:	MM6 Modular Gravity Unit (System Contractor: Morris Magnatronics, Palyria, Mars)
	AL4 Life Support System (System Contractor: A'Alakon Landiss, Divallax, Andor)





# STARLIGHT

## 2372 FEDERATION CUP WINNING ENTRY

**ADMIRAL CHRIS WALLACE**  
**SKIPPER - STARLIGHT**  
**APRIL 2380 EDITION**

The Federation Cup is one of the most-watched sporting and entertainment events in the Federation, ranking with the Rigel Cup fighter competition and the 24 Hours of New Le Mans starship endurance race. Almost every member world had solar sailor technology at one time in their history and the competition, held every four years, is well-represented. And though solar sailors go back centuries, those that compete in and for the Cup represent the absolute state of the art in design, manufacturing, and materials.

The Dominion War prevented the running of the 2376 race and therefore denied the 2372 winner the chance to defend her title. However, had the race been held, the outcome would have been foregone, for never before, nor since, has there been a vessel like *Starlight*.

Entered by Terra in 2372, the vessel was immediately immersed in controversy. Designed by a special group of the Star Fleet Advanced Starship Design Bureau, *Starlight* was, quite simply, generations beyond her nearest competitor. Built for the Unlimited Class, she was easily the largest vessel ever to be entered in competition. Her designers were the top experts in their fields at the ASDB and many of the smaller competitors in the Unlimited Class protested, saying that having such a "Tiger Team" was unfair. However, many of the other major worlds employed their own teams of highly-skilled specialists to design their entries, and the whole point of the

Unlimited Class was to push the boundaries — which *Starlight* did to the extreme. In addition, though she used Star Fleet personnel, they were "moonlighting" on their own time and the vessel was financed by a consortium of Terran shipbuilding concerns (McLaren Interstellar, Boeing-Mitsubishi Heavy Industries, and Daimler-Chrysler Aerospace) as a showcase of their prowess.

Commanded by the Chairman of the ASDB, Rear Admiral Chris Wallace, and the command crew of the *Galaxy (II)* starship USS *Bright Star*, *Starlight* obliterated all competition during the best-of-seven qualification heats. In the finals, the Bajoran and Alphan teams put up a strong fight — for second place. *Starlight* dispatched both teams with ease and won every heat by the largest margins in Cup history.

When entrants were announced for the 2380 race, *Starlight* was noticeably absent. Though automatically eligible (as the last Cup winner), Admiral Wallace announced he was too busy with new projects and that *Starlight* would remain in the Luna Museum of Spaceflight — much to the relief of the other competitors. It is unlikely we shall see a vessel like *Starlight* in the near future. She was a unique design financed by a huge consortium that could afford the untold millions of credits it cost to design and construct her.

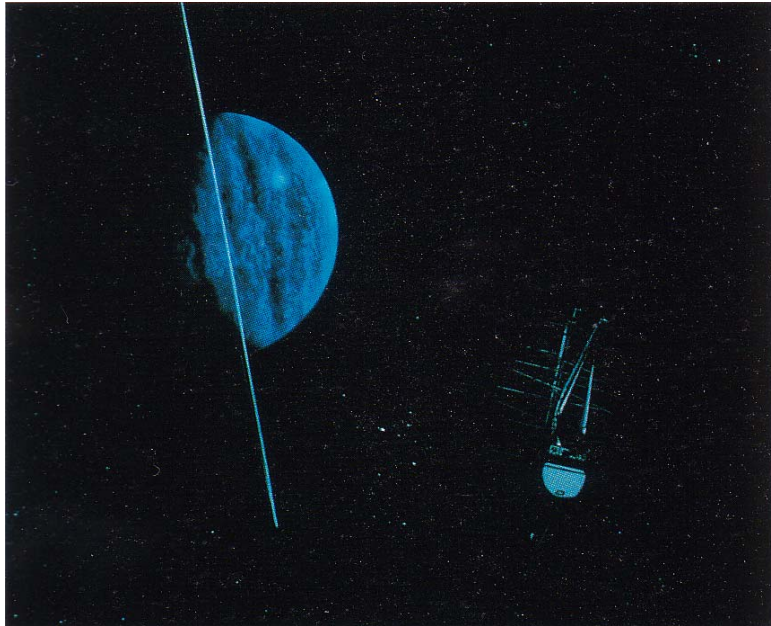

## Starlight Class Photon Sailship

Displacement	50,000 mt
Overall Length	100 m
Overall Draft	50 m
Overall Beam	25 m
Propulsion:	One FIGC-3 subatomic unified energy impulse unit (System Contractor: Kloratis Drives, Tellar)
	QASR-2 particle beam maneuvering thrusters (System Contractor: Scarbak Propulsion Systems, Earth)
	"Trentis IV" pulsed laser reaction control system (System Contractor: Orage Ijek, Aksajak, Andor)
Velocity:	Warp 0.8      Standard Cruising Speed Warp 0.9      Maximum Cruising Speed Warp 0.95     Maximum Attainable Velocity
Duration:	1 week
Complement:	5      Officers 40     Crew
Embarked Craft:	2      Transport Shuttles
Navigation:	RAV / ISHAK Mod 3-C Warp Celestial Guidance (System Contractor: Tlixis Ramab RRB, Coridan III)
Computers:	M-16 Bio-Neural Gel Pack-Isolinear III with LCARS 2.5 interface software (System Contractor: Daystrom Computer Systems, Luna)
Defense:	WCRC Type 17 Navigational Deflector Shield (System Contractor: Charlotte Shields, Earth)
Life Support:	MM6-C Modular Gravity Unit (System Contractor: Morris Magnatronics, Palyria, Mars) AL4-C Life Support System (System Contractor: A'Alakon Landiss, Divallax, Andor)

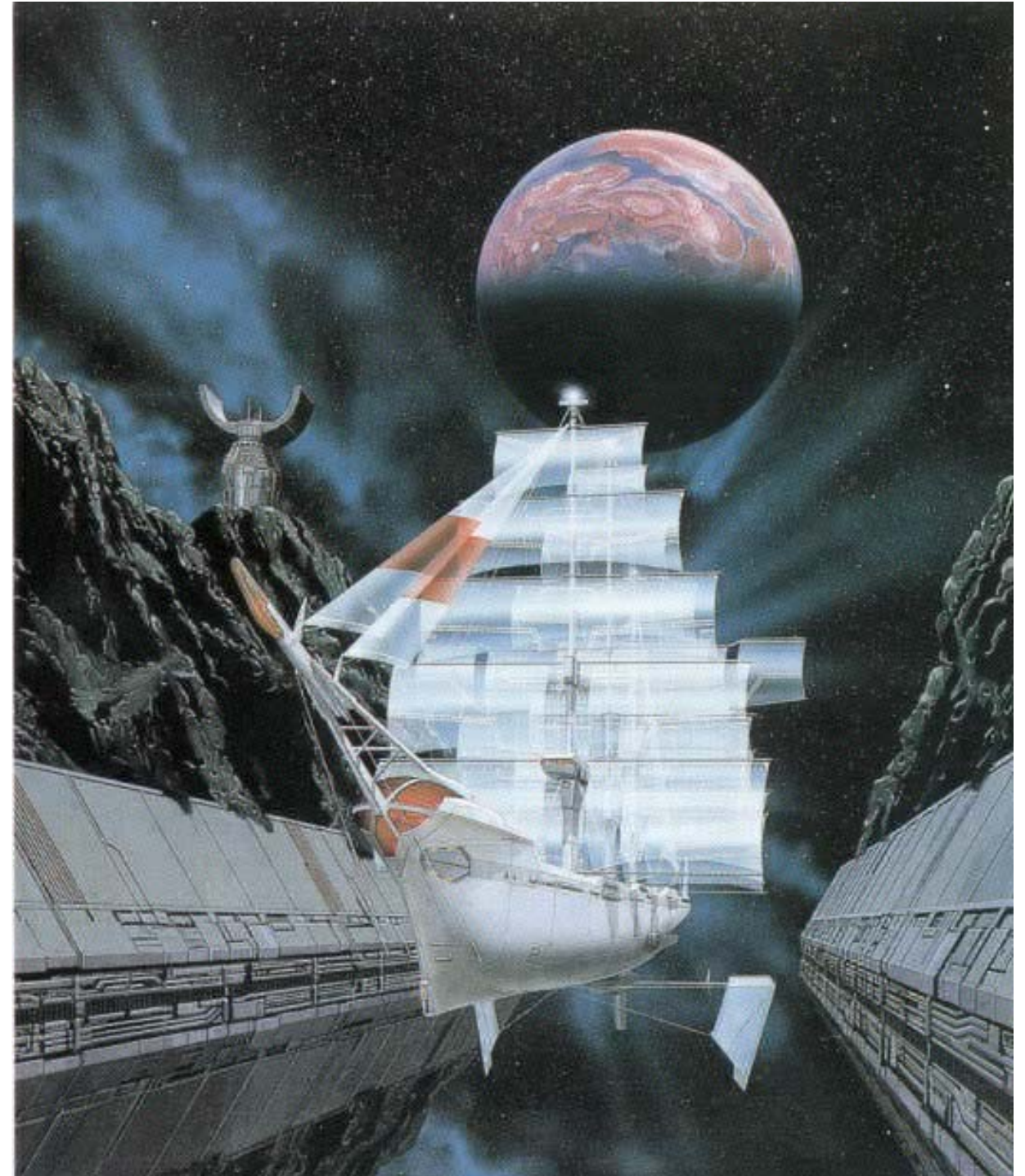

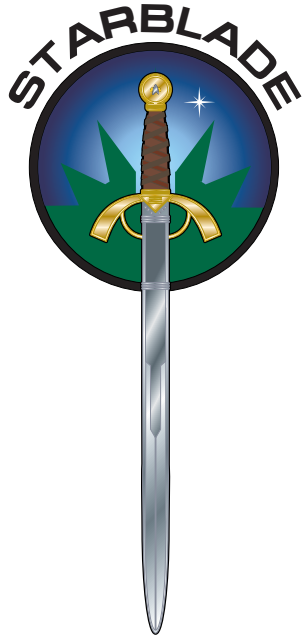

# STARBLADE

## STARLINER / COMMERCIAL SPACE TRANSPORT

KAGOME HIGURASHI  
EDITOR - STARSHIP DESIGN  
JULY 2387 EDITION

The newest, and to many people, most beautiful, spacecraft to enter commercial service is the passenger liner *Starblade*. This striking and original design is the first from McLaren Interstellar under the guidance of new Managing Director Chris Wallace.

After retiring from active duty with Star Fleet in 2381, Admiral Wallace accepted the position of Managing Director with McLaren Interstellar and began work with Senior Designer Adrian Newey on the most advanced liner to ever be built. Admiral Wallace enlisted the assistance of Boeing-Mitsubishi Heavy Industries, Daimler-Chrysler Aerospace and Shinohara Heavy Industries during the design and construction phases. The entire project was cloaked in the utmost secrecy and even the prototypes' test flights were conducted under maximum security.

The first *Starblade* to enter service in 2386 did so in one of the greatest blazes of publicity the Federation has ever known, and there can be few people who would not recognize this glittering vessel. Civilian traffic within the Federation has been on the rise in the decade since the end of the Dominion War and *Starblade* entered service at the peak of this wave.

Advertising superlatives aside, the *Starblade* is undoubtedly the most advanced ship of its kind and possesses features that will set standards for all subsequent spacecraft. The passenger accommodations are without equal, the Durasport Corporation setting a new level of luxury for even their lofty standards. Travel aboard *Starblade* is not inexpensive, but it is an experience that will never be forgotten.

However, the true revolution lay in both her hull design and the electronics contained within. Both Wallace and Newey were former Chairmen of the Star Fleet Advanced Starship Design Bureau and *Starblade* incorporates the absolute latest in cutting-edge starship design philosophies and disciplines. The angular hull maximizes high-warp efficiencies and the massive "winglets" are actually warp stabilators that result in a new level of ship control and ride-comfort. Their massive size makes them completely impractical on a Star Fleet vessel, which must take tactical issues into consideration. For a starliner, however, they provide the smoothest high-warp transit possible by constantly and minutely adjusting the warp field around the ship on a moment-by-moment basis.

*Starblade* incorporates the absolute latest in electronics, with a civilian version of the RAV-ISHAK Warp Celestial Guidance system that rivals those found on the latest Star Fleet explorers. In fact, *Starblade* is the first liner that can enter and exit warp within one million kilometers of a planet's gravity well, resulting in an average savings of close to ten hours in inner-system transit. *Starblade* is also the first civilian vessel to incorporate bio-neural isolinear computer systems.

Part of the experience of passenger travel starts at the docking port. *Starblade* has her own exclusive Departure Lounge at each of the ports of call she makes. Though she carries transporters, *Starblade* embarks and disembarks her passengers via two transport shuttles. Each is as luxuriously equipped as the ship and a large reception lounge is located off the main hanger bay where the passengers can socialize as the ship prepares to get underway.

The nine *Starblades* currently serve the core worlds of the Federation, as well as the primary resort and leisure planets, such as Risa. A tenth vessel is being completed to take over the famous *Andorian Express* run between Terra and Andor. Even more luxurious than her sisters, to reflect the "standard" of travel that all previous vessels to bear the *Express* name have set, her first year of service is already pre-booked.

## Starblade Class Starliner

Displacement	750,000 mt
Overall Length	300 m
Overall Draft	200 m
Overall Beam	150 m
Propulsion:	Two LFC-80 Mod 1 energized-energized antimatter warp drive units (System Contractor: Leeding Energies, Sydney, Earth) One FIGC-3 subatomic unified energy impulse unit (System Contractor: Kloratis Drives, Tellar) QASR-2 particle beam maneuvering thrusters (System Contractor: Scarbak Propulsion Systems, Earth) "Trentis IV" pulsed laser reaction control system (System Contractor: Orage Ijek, Aksajak, Andor)
Velocity:	Warp 8.0      Standard Cruising Speed Warp 9.0      Maximum Cruising Speed Warp 9.4      Maximum Attainable Velocity
Duration:	1 month
Complement:	5      Flight Crew 5      Technicians 40      Cabin Crew 300      Passengers
Embarked Craft:	2      Transport Shuttles
Navigation:	RAV / ISHAK Mod 3-C Warp Celestial Guidance (System Contractor: Tlixis Ramab RRB, Coridan III)
Computers:	M-16 Bio-Neural Gel Pack-Isolinear III with LCARS 2.5 interface software (System Contractor: Daystrom Computer Systems, Luna)
Defense:	WCRC Type 17 Navigational Deflector Shield (System Contractor: Charlotte Shields, Earth)
Life Support:	MM6-C Modular Gravity Unit (System Contractor: Morris Magnatronics, Palyria, Mars) AL4-C Life Support System (System Contractor: A'Alakon Landiss, Divallax, Andor)



# **APPENDICES**

# ABOUT THE PUBLISHING TEAM



## Chief Editor and Publisher: Admiral Chris Wallace

The current Chief of Star Fleet Operations, Admiral Wallace also served as the Executive Director of the *Galaxy* and *Galaxy (II)* Class starship development projects and is a former Chairman of the Advanced Starship Design Bureau. He was the Commanding Officer of both the U.S.S. *Bright Star* and U.S.S. *Galaxy*.



## Project Coordinator: Captain Belldandy Morisato

Captain Morisato has served as the Project Coordinator for most of DTS and ASDB's technical publications. She is the Executive Officer of the U.S.S. *Bright Star*.



## Layout Consultant: Sakura Shinguji

Ms. Shinguji serves as the Director of Publications for Panda Press Interstellar.



## Strategic Editor: Commander Natsumi Tsujimoto

Commander Tsujimoto serves as the Tactical Officer aboard the U.S.S. *Bright Star* and served on the battle planning and management staffs for most of the Dominion War's largest engagements.





**Production Editor: Rear Admiral Kurt Roithinger**

The former commander of the *Space Station Nexus*, Rear Admiral Roithinger has worked on a number of Star Fleet projects.



**Technical Editor: Admiral Alex Rosenzweig**

Admiral Rosenzweig is the current Director of the Star Fleet Department of Technical Services, as well as the Director of the Office of Technical Information. He has chaired numerous Star Fleet committees and panels, including the commission that oversaw the loss of the U.S.S. Enterprise at Veridian III.



**Engineering Consultant: Lieutenant Commander Skuld**

The Chief Engineering Officer of the U.S.S. *Bright Star*, Commander Skuld served on the *Galaxy (II)* Class Starship Development Project and is considered one of the top field engineers in Star Fleet.



**Systems Analyst: Rear Admiral Carsten Pedersen**

Considered one of the premiere designers at Star Fleet R&D, Admiral Pedersen has lent his talents to most of the starship designs put into production over the past decade.



**Naval Liaison: Rear Admiral John Scharmen**

Admiral Scharmen serves as the Naval Liaison between Star Fleet Operations and the Star Fleet Spacecraft Design Advisory Commission.



**Graphics: Commodore David Pipgras**

Commodore Pipgras is the Director of the Region Five Office of Graphic Design.



**Historical Liason: Lieutenant General Scott A. Akers**

General Akers serves as the Chief Historian of Star Fleet and assisted with the background histories of each class.



**Support Staff: Doctor Rick Sternbach**

Doctor Sternbach serves on the Advanced Propulsion Unit of the Advanced Starship Design Bureau. He was a senior member of the *Galaxy*, *Sovereign*, *Intrepid*, and *Defiant* Class Starship Development Projects.



**Support Staff: Doctor Michael Okuda**

Doctor Okuda serves on the Advanced Propulsion Unit of the Advanced Starship Design Bureau. He was a senior member of the *Galaxy*, *Sovereign*, *Intrepid*, and *Defiant* Class Starship Development Projects.



**Support Staff: Doctor Graham Kennedy**

A senior analyst with the Daystrom Technical Institute, Doctor Kennedy provided technical data for this publication.



**Senior Consultant: Dr. Bernd Schneider, PhD.**

Dr. Schneider is the Dean of the School of Astronautics at Annapolis. He is considered an expert of Vulcan and other alien spacecraft and has written numerous articles for PPI.

# CREDITS

## TEXT CREDITS

CHRIS WALLACE,

## COVER ILLUSTRATION

CHRIS WALLACE

## STARSHIP DEVELOPMENT PROGRAM AND FLEET YARD LOGOS

DAVID PIPGRAS, CHRIS WALLACE, RICK STERNBACH and  
MICHAEL OKUDA

## PERSONNEL PLAQUES

CHRIS WALLACE AND KURT ROITHINGER

# ART CREDITS

Deep Space Nine: Image by Viper. Model by Elim Garak.

Galaxy and Defiants: Image by Valiant. Galaxy model by Tom Cooper.  
Defiant by Skye Dodds.

Galaxy and Warbird: Image and Models by Mateen Greenway.

Klingon Vor'chas and Excelsior: Image and Models by Scifi-Art.com

USS Jaguar: Image and Model by Don Willits.

Starlight: Image by Zinsei Cho

Starblade: Image by Colin Hay

# AUTHOR'S NOTES

Welcome to [The Best of Dockyard Review](#). Since 1997, [Dockyard Review](#) has showcased ships from 2290 to 2380, as well as articles on starship technologies. When I created [Ships of the Star Fleet: 2378](#) in 1999, many of the starship articles in [Dockyard Review](#) were the starting point for the ship entries. These entries were fleshed out and, in some cases, came to directly contradict what was in [Dockyard Review](#) as new information become available. I spent all my time on [SOTSE](#) and essentially "abandoned" updating the original articles in [Dockyard Review](#).

When it came time to do the document overhaul for 2003, I decided to end [Dockyard Review](#). Instead, I took all the articles that did not cover ships showcased in [SOTSE](#) and created two "Best of" volumes to put them in.

As for [Dockyard Review](#), I doubt I will do any more. I saved the master files, just in case, but with the recent "expansion" of [SOTSE](#) to include new ships, as well as other projects like [Klingon Military Power](#) that covered the Klingon articles, I think there is no real need to keep them going.

The information contained within this volume is purely the conjecture of myself and is not meant to be deemed official or "canon" in any way. I have, where possible, used official Paramount sources for information. Where that has failed, I have gone to the web and other books.

STARFLEET ADVANCED STARSHIP DESIGN BUREAU